

# **APPENDIX J: 2032 LOCAL CAPACITY TECHNICAL STUDY**

**Intentionally left blank**

## Executive Summary

This report documents the results of the 2032 Long-Term Local Capacity Technical (LCT) Study. The LCT Study objectives, inputs, methodologies and assumptions are the same as those discussed in the 2023 LCT Study to be adopted by the CAISO and submitted to the CPUC for adoption in its 2023 Local Resource Adequacy process.

Overall, the Local Capacity area resource Requirements (LCR) trend compared with 2027, is up by about 4360 MW or about 18.5%. It is worth mentioning the following areas: (1) Humboldt, Stockton and San Diego-Imperial Valley where LCR has increased mostly due to load forecast increase and change in limiting constraint; (4) Sierra, Fresno, Bay Area, Kern, Big Creek/Ventura and LA Basin where LCR has increased mainly due to load forecast increase; (6) North Coast/North Bay, where LCR needs have decreased due to change in load distribution and transmission projects in the Bay Area.

The load forecast used in this study is based on the final adopted California Energy Demand Forecast 2021-2035, developed by the CEC; namely the load-serving entity (LSE) and balancing authority (BA) mid baseline demand with low additional achievable energy efficiency (AAEE) and high additional achievable fuel substitution (AAFS): <https://efiling.energy.ca.gov/GetDocument.aspx?tn=241384>.

The 2032 and 2027 total LCR needs are provided below for comparison:

### 2032 Local Capacity Needs

Local Area Name	Qualifying Capacity				Capacity Available at Peak	2032 LCR Need Category C
	QF/ Muni (MW)	Non-Solar (MW)	Solar (MW)	Total (MW)	Total (MW)	Capacity Needed
Humboldt	0	193	0	193	193	154
North Coast/ North Bay	138	773	0	911	911	911*
Sierra	1206	735	5	1946	1941	1450*
Stockton	112	627	16	755	739	755*
Greater Bay	611	7311	16	7938	7922	7936*
Greater Fresno	216	3437	467	4120	3861	2750*
Kern	6	446	75	527	452	424*
Big Creek/ Ventura	407	4238	531	5176	4645	1366
LA Basin	1080	8283	16	9379	9363	7388
San Diego/ Imperial Valley	2	5936	411	6349	5938	4849
<b>Total</b>	<b>3778</b>	<b>31979</b>	<b>1537</b>	<b>37294</b>	<b>35965</b>	<b>27983</b>

**2027 Local Capacity Needs**

Local Area Name	Qualifying Capacity				Capacity Available at Peak	2027 LCR Need Category C
	QF/ Muni (MW)	Non-Solar (MW)	Solar (MW)	Total (MW)	Total (MW)	Capacity Needed
Humboldt	0	178	0	178	147	147
North Coast/ North Bay	138	773	0	911	911	911*
Sierra	1206	698	5	1909	1904	1345*
Stockton	112	431	12	555	543	555*
Greater Bay	611	7151	8	7770	7770	7540*
Greater Fresno	216	2759	436	3411	2979	2179*
Kern	6	360	73	439	366	320*
Big Creek/ Ventura	407	3321	475	4203	4203	1126
LA Basin	1080	6368	11	7459	7454	6131
San Diego/ Imperial Valley	2	5390	396	5788	5392	3369*
<b>Total</b>	<b>3778</b>	<b>27429</b>	<b>1416</b>	<b>32623</b>	<b>31700</b>	<b>23623</b>

\* Details about magnitude of deficiencies can be found in the applicable section below. Resource deficient sub-area implies that in order to comply with the criteria, at summer peak, load may be shed immediately after the first contingency.

The narrative for each Local Capacity Area lists important new projects included in the base cases as well as a description of reason for changes between the 2027 Long-Term LCT study and this 2032 Long-Term LCT study.

This 2032 Long-Term Local Capacity Technical (LCT) Study was prepared in keeping with the ISO's current commitment to prepare biennial 10-year local capacity technical studies on an informational basis, to assist with the CPUC's Integrated Resource Planning process.

This 10-year study is the first prepared by the ISO that provides stakeholders with comprehensive load profile and transmission capacity profile information to provide additional insight into the nature of the local capacity needs additional information to understand the nature.

Table of Contents

Executive Summary .....	3
J.1 Overview of the Study: Inputs, Outputs and Options .....	7
J.1.1 Objectives.....	7
J.1.2 Key Study Assumptions.....	7
J.1.2.1 Inputs and Methodology.....	7
J.1.3 Grid Reliability.....	9
J.1.4 Application of N-1, N-1-1, and N-2 Criteria.....	10
J.1.5 Performance Criteria .....	10
J.1.5.1 Performance Criteria.....	10
J.1.5.2 CAISO Statutory Obligation Regarding Safe Operation .....	11
J.2 Assumption Details: How the Study was Conducted .....	15
J.2.1 System Planning Criteria .....	15
J.2.1.1 Power Flow Assessment:.....	18
J.2.1.2 Post Transient Load Flow Assessment: .....	19
J.2.1.3 Stability Assessment:.....	19
J.2.2 Load Forecast.....	19
J.2.2.1 System Forecast.....	19
J.2.2.2 Base Case Load Development Method.....	20
J.2.3 Power Flow Program Used in the LCR analysis.....	21
J.2.4 Estimate of Battery Storage Needs due to Charging Constraints .....	21
J.3 Locational Capacity Requirement Study Results .....	23
J.3.1 Summary of Study Results .....	23
J.3.2 Summary of Results by Local Area .....	26
J.3.2.1 Humboldt Area .....	26
J.3.2.2 North Coast / North Bay Area.....	29
J.3.2.3 Sierra Area.....	38
J.3.2.4 Stockton Area.....	46
J.3.2.5 Greater Bay Area.....	53
J.3.2.6 Greater Fresno Area .....	69
J.3.2.7 Kern Area.....	86
J.3.2.8 Big Creek/Ventura Area .....	97
J.3.2.9 LA Basin Area .....	106
J.3.2.10 San Diego-Imperial Valley Area .....	118
J.3.2.11 Valley Electric Area .....	127
Attachment A – List of physical resources by PTO, local area and market ID.....	128
Attachment B – Effectiveness factors for procurement guidance .....	180

**Intentionally left blank**

## **J.1 Overview of the Study: Inputs, Outputs and Options**

### **J.1.1 Objectives**

The intent of the 2032 Long-Term LCT Study is to identify specific areas within the CAISO Balancing Authority Area that have limited import capability and determine the minimum generation capacity (MW) necessary to mitigate the local reliability problems in those areas, as was the objective of all previous Local Capacity Technical Studies.

This 2032 Long-Term Local Capacity Technical (LCT) Study was prepared in keeping with the ISO's current commitment to prepare biennial 10-year local capacity technical studies on an informational basis, to assist with the CPUC's Integrated Resource Planning processes.

This 10-year study goes beyond the scope of previous 10-year local capacity technical studies and is the first prepared by the ISO that provides stakeholders with comprehensive load profile and transmission capacity profile information to provide additional insight into the nature of the local capacity needs additional information to understand the nature.

### **J.1.2 Key Study Assumptions**

#### **J.1.2.1 Inputs and Methodology**

The CAISO used the same Inputs and Methodology as agreed upon by interested parties and previously incorporated into the 2023 LCT Study. The following table sets forth a summary of the approved inputs and methodology that have been used in the 2023 LCT Study as well as this 2032 LCT Study:

Table J.1.2-1 Summary Table of Inputs and Methodology Used in this LCT Study:

Issue	How Incorporated into THIS LCT Study:
Input Assumptions:	
Transmission System Configuration	The existing transmission system has been modeled, including all projects operational on or before June 1, of the study year and all other feasible operational solutions brought forth by the PTOs and as agreed to by the CAISO.
Generation Modeled	The existing generation resources has been modeled and also includes all projects that will be on-line and commercial on or before June 1, of the study year
Load Forecast	Uses a 1-in-10 year summer peak load forecast
Methodology:	
Maximize Import Capability	Import capability into the load pocket has been maximized, thus minimizing the generation required in the load pocket to meet applicable reliability requirements.
QF/Nuclear/State/Federal Units	Regulatory Must-take and similarly situated units like QF/Nuclear/State/Federal resources have been modeled on-line at qualifying capacity output values for purposes of this LCT Study.
Maintaining Path Flows	Path flows have been maintained below all established path ratings into the load pockets, including the 500 kV. For clarification, given the existing transmission system configuration, the only 500 kV path that flows directly into a load pocket and will, therefore, be considered in this LCT Study is the South of Lugo transfer path flowing into the LA Basin.



Performance Criteria:	
All Performance Levels, including incorporation of PTO operational solutions	This LCT Study is being published based on the most stringent of all mandatory reliability standards. In addition, the CAISO will incorporate all new projects and other feasible and CAISO-approved operational solutions brought forth by the PTOs that can be operational on or before June 1, of the study year. Any such solutions that can reduce the need for procurement to meet the mandatory standards will be incorporated into the LCT Study.
Load Pocket:	
Fixed Boundary, including limited reference to published effectiveness factors	This LCT Study has been produced based on load pockets defined by a fixed boundary. The CAISO only publishes effectiveness factors where they are useful in facilitating procurement where excess capacity exists within a load pocket.

Further details regarding the 2023 as well as 2032 LCT Study methodology and assumptions are provided in Section III, below.

### J.1.3 Grid Reliability

Service reliability builds from grid reliability because grid reliability is reflected in the Reliability Standards of the North American Electric Reliability Council (NERC) and the Western Electricity Coordinating Council (“WECC”) Regional Criteria (collectively “Reliability Standards”). The Reliability Standards apply to the interconnected electric system in the United States and are intended to address the reality that within an integrated network, whatever one Balancing Authority Area does can affect the reliability of other Balancing Authority Areas. Consistent with the mandatory nature of the Reliability Standards, the CAISO is under a statutory obligation to ensure efficient use and reliable operation of the transmission grid consistent with achievement of the Reliability Standards.<sup>1</sup> The CAISO is further under an obligation, pursuant to its FERC-approved Transmission Control Agreement, to secure compliance with all “Applicable Reliability Criteria.” Applicable Reliability Criteria consists of the Reliability Standards as well as reliability criteria adopted by the CAISO (Grid Planning Standards).

The Reliability Standards define reliability on interconnected electric systems using the terms “adequacy” and “security.” “Adequacy” is the ability of the electric systems to supply the aggregate electrical demand and energy requirements of their customers at all times, taking into

---

<sup>1</sup> Pub. Utilities Code § 345

account physical characteristics of the transmission system such as transmission ratings and scheduled and reasonably expected unscheduled outages of system elements. “Security” is the ability of the electric systems to withstand sudden disturbances such as electric short circuits or unanticipated loss of system elements. The Reliability Standards are organized by Performance Categories. Certain categories require that the grid operator not only ensure that grid integrity is maintained under certain adverse system conditions (e.g., security), but also that all customers continue to receive electric supply to meet demand (e.g., adequacy). In that case, grid reliability and service reliability would overlap. But there are other levels of performance where security can be maintained without ensuring adequacy.

### **J.1.4 Application of N-1, N-1-1, and N-2 Criteria**

The CAISO will maintain the system in a safe operating mode at all times. This obligation translates into respecting the Reliability Criteria at all times, for example during normal operating conditions (N-0) the CAISO must protect for all single contingencies (N-1) and common mode (N-2) double line outages. Also, after a single contingency, the CAISO must re-adjust the system to support the loss of the next most stringent contingency. This is referred to as the N-1-1 condition.

The N-1-1 vs N-2 terminology was introduced only as a temporal differentiation between two existing NERC Category P6 and P7 events. N-1-1 represents NERC Category C6 (“category P1 contingency, manual system adjustment, followed by another category P1 contingency”). The N-2 represents NERC Category P7 (“any two circuits of a multiple circuit tower line”) as well as WECC-S2 (for 500 kV only) (“any two circuits in the same right-of-way”) with no manual system adjustment between the two contingencies.

### **J.1.5 Performance Criteria**

As set forth on the Summary Table of Inputs and Methodology, this LCR Report is based on the most stringent mandatory standard (NERC, WECC or CAISO). The CAISO tests the electric system in regards to thermal overloads as well as dynamic and reactive margin compliance with the existing standards.

#### **J.1.5.1 Performance Criteria**

Category P0, P1 & P3 system performance requires that all thermal and voltage limits must be within their “Applicable Rating,” which, in this case, are the emergency ratings as generally determined by the PTO or facility owner. Applicable Rating includes a temporal element such that emergency ratings can only be maintained for certain duration. Under this category, load cannot be shed in order to assure the Applicable Ratings are met however there is no guarantee that facilities are returned to within normal ratings or to a state where it is safe to continue to operate the system in a reliable manner such that the next element out will not cause a violation of the Applicable Ratings.

The NERC Planning Standards require system operators to “look forward” to make sure they safely prepare for the “next” N-1 following the loss of the “first” N-1 (stay within Applicable Ratings after the “next” N-1). This is commonly referred to as N-1-1. Because it is assumed that some

time exists between the “first” and “next” element losses, operating personnel may make any reasonable and feasible adjustments to the system to prepare for the loss of the second element, including, operating procedures, dispatching generation, moving load from one substation to another to reduce equipment loading, dispatching operating personnel to specific station locations to manually adjust load from the substation site, or installing a “Special Protection Scheme” that would remove pre-identified load from service upon the loss of the “next “ element.<sup>2</sup> All Category P2, P4, P5, P6, P7 and extreme event requirements in this report refer to situations when in real time (N-0) or after the first contingency (N-1) the system requires additional readjustment in order to prepare for the next worst contingency. In this time frame, load drop is not allowed per existing planning criteria.

Generally, Category P2, P4, P5, P6, P7 and extreme event describes system performance that is expected following the loss of two or more system elements. This loss of two elements is generally expected to happen simultaneously, referred to as N-2. It should be noted that once the “next” element is lost after the first contingency, as discussed above under the Performance Criteria P1, the event is effectively a Category P6 or N-1-1 scenario. As noted above, depending on system design and expected system impacts, the **planned and controlled** interruption of supply to customers (load shedding), the removal from service of certain generators and curtailment of exports may be utilized to maintain grid “security.”

#### **J.1.5.2 CAISO Statutory Obligation Regarding Safe Operation**

The ISO must maintain the system in a safe operating mode at all times. This obligation translates into respecting the Reliability Criteria at all times. For example, during normal operating conditions (8760 hours per year), the ISO must protect for all single contingencies (P1, P2) and multiple contingencies (P4, P5) as well as common mode double line outages (P7). As a further example, after a single contingency, the ISO must readjust the system in order to be able to support the loss of the next most stringent contingency (P3 , P6 and P1+P7 resulting in potential voltage collapse or dynamic instability).

---

<sup>2</sup> A Special Protection Scheme is typically proposed as an operational solution that does not require additional generation and permits operators to effectively prepare for the next event as well as ensure security should the next event occur. However, these systems have their own risks, which limit the extent to which they could be deployed as a solution for grid reliability augmentation. While they provide the value of protecting against the next event without the need for pre-contingency load shedding, they add points of potential failure to the transmission network. This increases the potential for load interruptions because sometimes these systems will operate when not required and other times they will not operate when needed.

Figure J.1.5-1 Temporal graph of LCR Category P0-P7

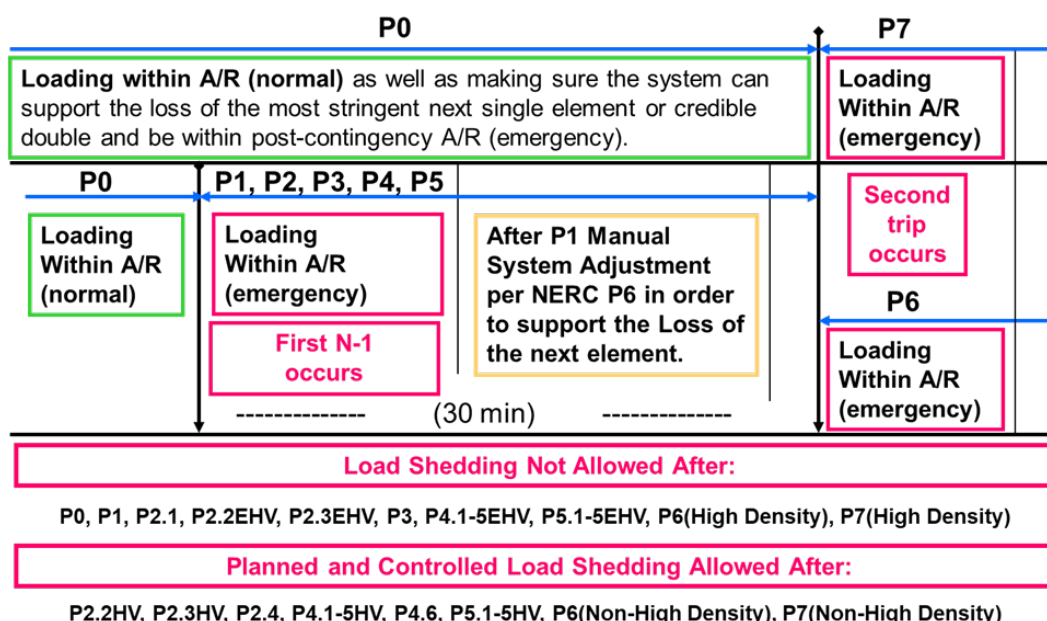

The following definitions guide the CAISO’s interpretation of the Reliability Criteria governing safe mode operation and are used in this LCT Study:

**Applicable Rating:**

This represents the equipment rating that will be used under certain contingency conditions.

*Normal rating* is to be used under normal conditions.

*Long-term emergency ratings*, if available, will be used in all emergency conditions as long as “system readjustment” is provided in the amount of time given (specific to each element) to reduce the flow to within the normal ratings. If not available, the normal rating is to be used.

*Short-term emergency ratings*, if available, can be used as long as “system readjustment” is provided in the “short-time” available in order to reduce the flow to within the long-term emergency ratings where the element can be kept for another length of time (specific to each element) before the flow needs to be reduced the below the normal ratings. If not available long-term emergency rating should be used.

*Temperature-adjusted ratings* shall not be used because this is a year-ahead study, not a real-time tool, and as such the worst-case scenario must be covered. In case temperature-adjusted ratings are the only ratings available then the minimum rating (highest temperature) given the study conditions shall be used.

*CAISO Transmission Register* is the only official keeper of all existing ratings mentioned above.

*Ratings for future projects* provided by PTO and agreed upon by the CAISO shall be used.

Other short-term ratings not included in the CAISO Transmission Register may be used as long as they are engineered, studied and enforced through clear operating procedures that can be followed by real-time operators.

Path Ratings need to be maintained within their limits in order to assure that proper capacity is available in order to operate the system in real-time in a safe operating zone.

### **Controlled load drop:**

This is achieved with the use of a Special Protection Scheme.

### **Planned load drop:**

This is achieved when the most limiting equipment has short-term emergency ratings AND the operators have an operating procedure that clearly describes the actions that need to be taken in order to shed load.

### **Special Protection Scheme:**

All known SPS shall be assumed. New SPS must be verified and approved by the CAISO and must comply with the new SPS guideline described in the CAISO Planning Standards.

### **System Readjustment:**

This represents the actions taken by operators in order to bring the system within a safe operating zone after any given contingency in the system.

Actions that can be taken as system readjustment after a Category P1, P2.1, P2.2(EHV), P2.3(EHV), P3, P4.1-5(EHV), P5.1-5(EHV), P6(high density area)&P7(high density area) contingency:

1. System configuration change – based on validated and approved operating procedures
2. Generation re-dispatch
  - a. Decrease generation (up to 1150 MW) – limit given by single contingency SPS as part of the ISO Grid Planning standards (ISO SPS3)
  - b. Increase generation – this generation will become part of the LCR need

Actions, which shall not be taken as system readjustment after a Category P1, P2.1, P2.2(EHV), P2.3(EHV), P3, P4.1-5(EHV), P5.1-5(EHV), P6(high density area)&P7(high density area) contingency:

1. Load drop – based on the intent of the ISOWECC and NERC criteria for category P1 contingencies.

An objective of the planning process is to minimize the likelihood and magnitude of Non-Consequential Load Loss following Contingency events. NERC and ISO Planning standards mandate that no load shedding should be done immediately after a Category P1, P2.1,

P2.2(EHV), P2.3(EHV), P3, P4.1-5(EHV), P5.1-5(EHV), P6(high density area)&P7(high density area) contingency. The system should be planned with no load shedding regardless of when it may occur (immediately or within 15-30 minutes after the first contingency). It follows that load shedding may not be utilized as part of the system readjustment period – in order to protect for the next most limiting contingency. Therefore, if there are available resources in the local area, such resources should be used during the manual adjustment period (and included in the LCR need) before resorting to shedding firm load.

Firm load shedding is allowed in a planned and controlled manner after the first contingency in P2.2(HV), P2.3(HV), P2.4, P4.1-5(HV), P4.6, P5.1-5(HV) and after the second contingency in P6(non-high density area), P7(non-high density area) & P1 system adjusted followed by P7 category events.

This interpretation tends to guarantee that firm load shedding is used to address Category P1, P2.1, P2.2(EHV), P2.3(EHV), P3, P4.1-5(EHV), P5.1-5(EHV), P6(high density area)&P7(high density area) conditions only under the limited circumstances where no other resource or validated operational measure is available. A contrary interpretation would constitute a departure from existing practice and degrade current service expectations by increasing load's exposure to service interruptions.

**Time allowed for manual readjustment:**

Tariff Section 40.3.1.1, requires the CAISO, in performing the Local Capacity Technical Study, to apply the following reliability criterion:

Time Allowed for Manual Adjustment: This is the amount of time required for the Operator to take all actions necessary to prepare the system for the next Contingency. The time should not be more than thirty (30) minutes.

The CAISO Planning Standards also impose this manual readjustment requirement. As a parameter of the Local Capacity Technical Study, the CAISO must assume that as the system operator the CAISO will have sufficient time to:

- (1) make an informed assessment of system conditions after a contingency has occurred;
- (2) identify available resources and make prudent decisions about the most effective system redispatch;
- (3) manually readjust the system within safe operating limits after a first contingency to be prepared for the next contingency; and
- (4) allow sufficient time for resources to ramp and respond according to the operator's redispatch instructions. This all must be accomplished within 30 minutes.

Local capacity resources can meet this requirement by either (1) responding with sufficient speed, allowing the operator the necessary time to assess and redispatch resources to effectively reposition the system within 30 minutes after the first contingency, or (2) have sufficient energy available for frequent dispatch on a pre-contingency basis to ensure the operator can meet minimum online commitment constraints or reposition the system within 30 minutes after the first contingency occurs. Accordingly, when evaluating resources that satisfy the requirements of the CAISO Local Capacity Technical Study, the CAISO assumes that local capacity resources need to be available in no longer than 20 minutes so the CAISO and demand response providers have a reasonable opportunity to perform their respective and necessary tasks and enable the CAISO to reposition the system within the 30 minutes in accordance with applicable reliability criteria.

## J.2 Assumption Details: How the Study was Conducted

### J.2.1 System Planning Criteria

The following table provides a comparison of system planning criteria, based on the NERC performance standards, used in the study:

Table J.2.1-1: Criteria Comparison for Bulk Electric System contingencies

Contingency Component(s)	Mandatory Reliability Standards	Old Local Capacity Criteria	Local Capacity Criteria
<b><u>P0 – No Contingencies</u></b>	X	X	X
<b><u>P1 – Single Contingency</u></b>			
1. Generator (G-1)	X	X <sup>1</sup>	X <sup>1</sup>
2. Transmission Circuit (L-1)	X	X <sup>1</sup>	X <sup>1</sup>
3. Transformer (T-1)	X	X <sup>1,2</sup>	X <sup>1</sup>
4. Shunt Device	X		X <sup>1</sup>
5. Single Pole (dc) Line	X	X <sup>1</sup>	X <sup>1</sup>
<b><u>P2 – Single contingency</u></b>			
1. Opening a line section w/o a fault	X		X
2. Bus Section fault	X		X
3. Internal Breaker fault (non-Bus-tie Breaker)	X		X
4. Internal Breaker fault (Bus-tie Breaker)	X		X
<b><u>P3 – Multiple Contingency – G-1 + system adjustment and:</u></b>			
1. Generator (G-1)	X	X	X
2. Transmission Circuit (L-1)	X	X	X
3. Transformer (T-1)	X	X <sup>2</sup>	X
4. Shunt Device	X		X
5. Single Pole (dc) Line	X	X	X

<b><u>P4 – Multiple Contingency - Fault plus stuck breaker</u></b>			
1. Generator (G-1)	X		X
2. Transmission Circuit (L-1)	X		X
3. Transformer (T-1)	X		X
4. Shunt Device	X		X
5. Bus section	X		X
6. Bus-tie breaker	X		X
<b><u>P5 – Multiple Contingency – Relay failure (delayed clearing)</u></b>			
1. Generator (G-1)	X		X
2. Transmission Circuit (L-1)	X		X
3. Transformer (T-1)	X		X
4. Shunt Device	X		X
5. Bus section	X		X
<b><u>P6 – Multiple Contingency – P1.2-P1.5 system adjustment and:</u></b>			
1. Transmission Circuit (L-1)	X	x	X
2. Transformer (T-1)	X	x	X
3. Shunt Device	X		X
4. Bus section	X		X
<b><u>P7 – Multiple Contingency - Fault plus stuck breaker</u></b>			
1. Two circuits on common structure (L-2)	X	X	X
2. Bipolar DC line	X	X	X
<b><u>Extreme event – loss of two or more elements</u></b>			
Two generators (Common Mode) G-2	X <sup>4</sup>	X	X <sup>4</sup>
Any P1.1-P1.3 & P1.5 system readjusted (Common Mode) L-2	X <sup>4</sup>	X <sup>3</sup>	X <sup>5</sup>
All other extreme combinations.	X <sup>4</sup>		X <sup>4</sup>
<p><sup>1</sup> System must be able to readjust to a safe operating zone in order to be able to support the loss of the next contingency.</p> <p><sup>2</sup> A thermal or voltage criterion violation resulting from a transformer outage may not be cause for a local area reliability requirement if the violation is considered marginal (e.g. acceptable loss of facility life or low voltage), otherwise, such a violation will necessitate creation of a requirement.</p> <p><sup>3</sup> Evaluate for risks and consequence, per NERC standards. No voltage collapse or dynamic instability allowed.</p> <p><sup>4</sup> Evaluate for risks and consequence, per NERC standards.</p> <p><sup>5</sup> Expanded to include any P1 system readjustment followed by any P7 without stuck breaker. For voltage collapse or dynamic instability situations mitigation is required “if there is a risk of cascading” beyond a relatively small predetermined area – less than 250 MW - directly affected by the outage.</p>			



Table J.2.1-2: Criteria Comparison for non-Bulk Electric System contingencies

Contingency Component(s)	Mandatory Reliability Standards	Old Local Capacity Criteria	Local Capacity Criteria
<b><u>P0 – No Contingencies</u></b>	X	X	X
<b><u>P1 – Single Contingency</u></b>			
1. Generator (G-1)	X	X <sup>1</sup>	X
2. Transmission Circuit (L-1)	X	X <sup>1</sup>	X
3. Transformer (T-1)	X	X <sup>1,2</sup>	X
4. Shunt Device	X		X
5. Single Pole (dc) Line	X	X <sup>1</sup>	X
<b><u>P2 – Single contingency</u></b>			
1. Opening a line section w/o a fault			
2. Bus Section fault			
3. Internal Breaker fault (non-Bus-tie Breaker)			
4. Internal Breaker fault (Bus-tie Breaker)			
<b><u>P3 – Multiple Contingency – G-1 + system adjustment and:</u></b>			
1. Generator (G-1)	X	X	X
2. Transmission Circuit (L-1)	X	X	X
3. Transformer (T-1)	X	X <sup>2</sup>	X
4. Shunt Device	X		X
5. Single Pole (dc) Line	X	X	X
<b><u>P4 – Multiple Contingency - Fault plus stuck breaker</u></b>			
1. Generator (G-1)			
2. Transmission Circuit (L-1)			
3. Transformer (T-1)			
4. Shunt Device			
5. Bus section			
6. Bus-tie breaker			
<b><u>P5 – Multiple Contingency – Relay failure (delayed clearing)</u></b>			
1. Generator (G-1)			
2. Transmission Circuit (L-1)			
3. Transformer (T-1)			
4. Shunt Device			
5. Bus section			
<b><u>P6 – Multiple Contingency – P1.2-P1.5 system adjustment and:</u></b>			
1. Transmission Circuit (L-1)		x	
2. Transformer (T-1)		x	
3. Shunt Device			
4. Bus section			
<b><u>P7 – Multiple Contingency - Fault plus stuck breaker</u></b>			
1. Two circuits on common structure (L-2)		X	
2. Bipolar DC line		X	

<p><b>Extreme event – loss of two or more elements</b>                  Two generators (Common Mode) G-2                  Any P1.1-P1.3 &amp; P1.5 system readjusted (Common Mode) L-2                  All other extreme combinations.</p>		<p>X                  X<sup>3</sup></p>	
<p><sup>1</sup> System must be able to readjust to a safe operating zone in order to be able to support the loss of the next contingency.  <sup>2</sup> A thermal or voltage criterion violation resulting from a transformer outage may not be cause for a local area reliability requirement if the violation is considered marginal (e.g. acceptable loss of facility life or low voltage), otherwise, such a violation will necessitate creation of a requirement.  <sup>3</sup> Evaluate for risks and consequence, per NERC standards. No voltage collapse or dynamic instability allowed.</p>			

A significant number of simulations were run to determine the most critical contingencies within each local area. Using power flow, post-transient load flow, and stability assessment tools, the system performance results of all tested contingencies were measured against the system performance requirements defined by the criteria shown in Tables 1 and 2. Where the specific system performance requirements were not met, generation was adjusted until performance requirements were met for the local area. The adjusted generation constitutes the minimum generation needed in the local area. The following describes how the criteria were tested for the specific type of analysis performed.

**J.2.1.1 Power Flow Assessment:**

Table J.2.1-3 Power flow criteria

Contingencies	Thermal Criteria <sup>1</sup>	Voltage Criteria <sup>2</sup>
P0	Applicable Rating	Applicable Rating
P1 <sup>3</sup>	Applicable Rating	Applicable Rating
P2	Applicable Rating	Applicable Rating
P3	Applicable Rating	Applicable Rating
P4	Applicable Rating	Applicable Rating
P5	Applicable Rating	Applicable Rating
P6 <sup>4</sup>	Applicable Rating	Applicable Rating
P7	Applicable Rating	Applicable Rating
P1 + P7 <sup>4</sup>	-	No Voltage Collapse

- <sup>1</sup> Applicable Rating – Based on CAISO Transmission Register or facility upgrade plans including established Path ratings.
- <sup>2</sup> Applicable Rating – CAISO Grid Planning Criteria or facility owner criteria as appropriate.
- <sup>3</sup> Following the first contingency (N-1), the generation must be sufficient to allow the operators to bring the system back to within acceptable operating range (voltage and loading) and/or appropriate OTC following the studied outage conditions and be able to

safely prepare for the loss of the next most stringent element and be within Applicable Rating after the loss of the second element.

- 4 During normal operation or following the first contingency (N-1), the generation must be sufficient to allow the operators to prepare for the next worst N-1 or common mode N-2 without pre-contingency interruptible or firm load shedding. SPS/RAS/Safety Nets may be utilized to satisfy the criteria after the second N-1 or common mode N-2 except if the problem is of a thermal nature such that short-term ratings could be utilized to provide the operators time to shed either interruptible or firm load.

### J.2.1.2 Post Transient Load Flow Assessment:

Table J.2.1-4 Post transient load flow criteria

Contingencies	Reactive Margin Criteria <sup>2</sup>
Selected <sup>1</sup>	Applicable Rating

- <sup>1</sup> If power flow results indicate significant low voltages for a given power flow contingency, simulate that outage using the post transient load flow program. The post-transient assessment will develop appropriate Q/V and/or P/V curves.
- <sup>2</sup> Applicable Rating – positive margin based on the higher of imports or load increase by 5% for N-1 contingencies, and 2.5% for N-2 contingencies.

### J.2.1.3 Stability Assessment:

Table J.2.1-5 Stability criteria

Contingencies	Stability Criteria <sup>2</sup>
Selected <sup>1</sup>	Applicable Rating

- <sup>1</sup> Base on historical information, engineering judgment and/or if power flow or post transient study results indicate significant low voltages or marginal reactive margin for a given contingency.
- <sup>2</sup> Applicable Rating – CAISO Grid Planning Criteria or facility owner criteria as appropriate.

## J.2.2 Load Forecast

### J.2.2.1 System Forecast

The California Energy Commission (CEC) derives the load forecast at the system and Participating Transmission Owner (PTO) levels. This relevant CEC forecast is then distributed across the entire system, down to the local area, division and substation level. The PTOs use an econometric equation to forecast the system load. The predominant parameters affecting the

system load are (1) number of households, (2) economic activity (gross metropolitan products, GMP), (3) temperature and (4) increased energy efficiency and distributed generation programs.

### **J.2.2.2 Base Case Load Development Method**

The method used to develop the load in the base case is a melding process that extracts, adjusts and modifies the information from the system, distribution and municipal utility forecasts. The melding process consists of two parts: Part 1 deals with the PTO load and Part 2 deals with the municipal utility load. There may be small differences between the methodologies used by each PTO to disaggregate the CEC load forecast to their level of local area as well as bar-bus model.

#### **J.2.2.2.1 PTO Loads in Base Case**

The methods used to determine the PTO loads are, for the most part, similar. One part of the method deals with the determination of the division<sup>3</sup> loads that would meet the requirements of 1-in-5 or 1-in-10 system or area base cases and the other part deals with the allocation of the division load to the transmission buses.

##### **a. Determination of division loads**

The annual division load is determined by summing the previous year division load and the current division load growth. Thus, the key steps are the determination of the initial year division load and the annual load growth. The initial year for the base case development method is based heavily on recorded data. The division load growth in the system base case is determined in two steps. First, the total PTO load growth for the year is determined, as the product of the PTO load and the load growth rate from the system load forecast. Then this total PTO load growth is allocated to the division, based on the relative magnitude of the load growth projected for the divisions by the distribution planners. For example, for the 1-in-10 area base case, the division load growth determined for the system base case is adjusted to the 1-in-10 temperature using the load temperature relation determined from the latest peak load and temperature data of the division.

##### **b. Allocation of division load to transmission bus level**

Since the loads in the base case are modeled at the various transmission buses, the division loads developed must be allocated to those buses. The allocation process is different depending on the load types. For the most part, each PTO classifies its loads into four types: conforming, non-conforming, self-generation and generation-plant loads. Since the non-conforming and self-generation loads are assumed to not vary with temperature, their magnitude would be the same in the system or area base cases of the same year. The remaining load (the total division load developed above, less the quantity of non-conforming and self-generation load) is the conforming load. The remaining load is allocated to the transmission buses based on the relative magnitude of the distribution forecast. The summation of all base case loads is generally higher than the load forecast because some load, i.e., self-generation and generation-plant, are behind the meter and

---

<sup>3</sup> Each PTO divides its territory in a number of smaller area named divisions. These are usually smaller and compact areas that have the same temperature profile.

must be modeled in the base cases. However, for the most part, metered or aggregated data with telemetry is used to come up with the load forecast.

#### **J.2.2.2 Municipal Loads in Base Case**

The municipal utility forecasts that have been provided to the CEC and PTOs for the purposes of their base cases were also used for this study.

### **J.2.3 Power Flow Program Used in the LCR analysis**

The technical studies were conducted using General Electric's Power System Load Flow (GE PSLF) program version 22.0.2 and PowerGem's Transmission Adequacy and Reliability Assessment (TARA) program version 2202.2. This GE PSLF program is available directly from GE or through the Western System Electricity Council (WECC) to any member and TARA program is commercially available.

To evaluate Local Capacity Areas, the starting base case was adjusted to reflect the latest generation and transmission projects as well as the one-in-ten-year peak load forecast for each Local Capacity Area as provided to the CAISO by the PTOs.

Electronic contingency files provided by the PTOs were utilized to perform the numerous contingencies required to identify the LCR. These contingency files include remedial action and special protection schemes that are expected to be in operation during the year of study. A CAISO created EPCL (a GE programming language contained within the GE PSLF package) routine and/or TARA software were used to run the combination of contingencies; however, other routines are available from WECC with the GE PSFL package or can be developed by third parties to identify the most limiting combination of contingencies requiring the highest amount of generation within the local area to maintain power flows within applicable ratings.

### **J.2.4 Estimate of Battery Storage Needs due to Charging Constraints**

Local areas and sub-areas have limited transmission capability and therefore rely on internal resources to be available in order to reliably serve internal load. Battery storage will help serve local load during the discharge cycle, however it will also increase local load during the charging cycle.

Due to recent procurement activities geared toward the acquisition of this type of technology, the CAISO is herein estimating the characteristics (MW, MWh, discharge duration) required from battery storage technology in order to seamlessly integrate in each local area and sub-area.

The CAISO expects that for batteries that displace other local resource adequacy resources, the transmission capability under the most limiting contingency and the other local capacity resources must be sufficient to recharge the batteries in anticipation of the outage continuing through the night and into the next day's peak load period.

For each local area and sub-area, the CAISO has estimated the battery storage characteristics, given their unique load shape, constraints and requirements as well as the energy characteristics of other resources required to meet standards. Due to this fact, the strict addition of the sub-area

battery storage characteristics (MW, MWh and duration) may not closely align with the overall local area battery storage characteristic requirements (MW, MWh and duration).

### Assumptions

- 1) Total load serving capability includes capability from transmission system and local generation needed for LCR under the worst contingency.
- 2) Storage added replaces existing generation MW for MW. First the batteries will replace as much as possible of existing gas resources, Second if the area and/or sub-area has run out of gas resources to displace then other technologies may be reduced in order to determine the maximum battery charging limit.
- 3) Effectiveness factors are assumed not to be a factor. Battery storage is assumed to be installed at the same sites where resources are displaced or assumed to have the same effectiveness factors.
- 4) Deliverability of incremental storage capacity is not evaluated. It is assumed battery storage will take over deliverability from old resources through repower. Any new battery storage resource needs to go through the generation interconnection process in order to receive deliverability and it is not evaluated in this study. CAISO cannot guaranty that there is enough deliverability available for new resources. New transmission upgrades may be required in order to make such new resources deliverable to the aggregate of load.
- 5) Includes battery storage charging/discharging efficiency of 85%.
- 6) Daily charging required is distributed to all non-discharging hours proportionally using delta between net load and the total load serving capability.
- 7) Energy required for charging, beyond the transmission capability under contingency condition, is produced by other LCR required resources within the local area and sub-area that are available for production during off-peak hours.
- 8) Hydro resources are considered to be available for production during off-peak hours, however these resources are energy limited themselves and based on past availability data they can have severely limited output during off-peak hours especially during late summer peaks under either normal or dry hydro years.
- 9) The study assumes the ability to provide perfect dispatch and the ability to enforce charging requirements for multiple contingency conditions (like N-1-1) in the day ahead time frame while the system is under normal (no contingency) conditions. CAISO software improvements and/or augmentations are required in order to achieve this goal.

Installing battery storage with insufficient characteristics (MW, MWh and duration) will not result in a one for one reduction of the local area or sub-area need for other types of resources. The CAISO expects that the overall RA portfolio provided by all LSEs to account for the uplift, beyond the minimum LCR need, in MWs required from other type of resources for all areas and sub-areas where LSEs have procured battery storage beyond the charging capability or with incorrect characteristics (MW, MWh and duration). If uplift is not provided the CAISO may use its back stop authority to assure that reliability standards are met throughout the day, including off-peak hours.

## J.3 Locational Capacity Requirement Study Results

### J.3.1 Summary of Study Results

LCR is defined as the amount of resource capacity that is needed within a Local Capacity Area to reliably serve the load located within this area. The results of the CAISO's analysis are summarized in the Executive Summary Tables.

Table J.3.1-1 2032 Local Capacity Needs vs. Peak Load and Local Area Resources

	2032 Total LCR (MW)	Peak Load (1 in10) (MW)	2032 LCR as % of Peak Load	Total NQC Local Area Resources (MW)	2032 LCR as % of Total NQC
Humboldt	154	182	85%	193	80%
North Coast/North Bay	911	1854	49%	911	100%
Sierra	1450	2104	69%	1946	75%
Stockton	755	1050	72%	755	100%
Greater Bay	7936	13429	59%	7938	100%
Greater Fresno	2750	3913	70%	4120	67%
Kern	424	1011	42%	527	80%
Big Creek/Ventura	1366	4854	28%	5176	26%
LA Basin	7388	21107	35%	9379	79%
San Diego/Imperial Valley	4849	5410	90%	6349	76%
<b>Total*</b>	<b>27983</b>	<b>54914</b>	<b>51%</b>	<b>37294</b>	<b>75%</b>

Table J.3.1-2 2027 Local Capacity Needs vs. Peak Load and Local Area Resources

	2027 Total LCR (MW)	Peak Load (1 in10) (MW)	2027 LCR as % of Peak Load	Total NQC Local Area Resources (MW)	2027 LCR as % of Total NQC
Humboldt	147	180	82%	178	83%
North Coast/North Bay	911	1521	60%	911	100%
Sierra	1345	1901	71%	1909	70%
Stockton	555	1147	48%	555	100%
Greater Bay	7540	11733	64%	7770	97%
Greater Fresno	2179	3392	64%	3411	64%
Kern	320	945	34%	439	73%
Big Creek/Ventura	1126	4497	25%	4203	27%
LA Basin	6131	19911	31%	7459	82%
San Diego/Imperial Valley	3369	4995	67%	5788	58%
<b>Total*</b>	<b>23623</b>	<b>50222</b>	<b>47%</b>	<b>32623</b>	<b>72%</b>

\* Value shown only illustrative, since each local area peaks at a different time.

Table J.3.1-1 and Table J.3.1-2 shows how much of the Local Capacity Area load is dependent on local resources and how many local resources must be available in order to serve the load in those Local Capacity Areas in a manner consistent with the Reliability Criteria. These tables also indicate where new transmission projects, new resource additions or demand side management programs would be most useful in order to reduce the dependency on existing, generally older and less efficient local area resources.

The term “Qualifying Capacity” used in this report is the “Net Qualifying Capacity” (“NQC”) posted on the CAISO web site at:

<http://www.caiso.com/planning/Pages/ReliabilityRequirements/Default.aspx>

The NQC list includes the area (if applicable) where each resource is located for units already operational. Neither the NQC list nor this report incorporates Demand Side Management programs and their related NQC. Units scheduled to become operational before June 1 of 2032 have been included in this 2032 Long-Term LCR Report and added to the total NQC values for those respective areas (see detail write-up for each area).

Regarding the main tables up front (page 2), the first column, “August Qualifying Capacity,” reflects three sets of resources. The first set is comprised of resources that would normally be expected to be on-line such as Municipal and Regulatory Must-take resources (state, federal, municipal and QFs). The second set is “market” based resources (market, net seller, wind and battery). The third set are solar resources, since they may or may not be available during the actual peak hour for the respective local area. The second column, “Capacity at Peak” identifies how much of the August Qualifying Capacity is expected to be available during the peak time for each particular local area. The third column, “YEAR LCR Need”, sets forth the local capacity requirements, without the deficiencies that must be addressed, necessary to attain a service reliability level required to comply with NERC/WECC/CAISO mandatory reliability standards.

Table J.3.1-3 includes estimated characteristics (MW, MWh, discharge duration) required from battery storage technology in order to seamlessly integrate in each local area and sub-area. The CAISO expects that for batteries that displace other local resource adequacy resources, the transmission capability under the most limiting contingency and the other local capacity resources must be sufficient to recharge the batteries in anticipation of the outage continuing through the night and into the next day’s peak load period.

Table J.3.1-3 2032 Battery Storage Characteristics Limited by Charging Capability

Area/Sub-area	Pmax MW	Energy MWh	Max. # of discharge hours	Max. MW of 4 hour battery (1 for 1 MW replacement)	Replacing mostly	Comment
Humboldt	19	76	11	19	gas	
North Coast/North Bay Overall	410	3101	12	300	geothermal	
Eagle Rock	75	485	10	25	geothermal	
Fulton	265	1550	9	175	geothermal	
Sierra	-	-	-	-	-	Flow through
Placer	96	477	10	75	hydro	



Area/Sub-area	Pmax MW	Energy MWh	Max. # of discharge hours	Max. MW of 4 hour battery (1 for 1 MW replacement)	Replacing mostly	Comment
Pease	-	-	-	-	-	Need eliminated
South of Rio Osos	-	-	-	-	-	Flow through
Stockton	-	-	-	-	-	Sum of sub-areas
Lockeford	-	-	-	-	-	Need eliminated
Tesla-Bellota	546	4111	16	545	gas	
Greater Bay Overall	2970	15039	9	2220	gas	
Llagas	80	556	10	18	gas	
San Jose	850	2143	15	536	gas	
South Bay-Moss Landing	1010	5641	19	965	gas	
Oakland	-	-	-	-	distillate	Limit reached
Greater Fresno Overall	1223	5965	10	793	hydro	
Panoche	120	971	12	53	gas	
Herndon	450	2531	9	260	hydro	
Borden	-	-	-	-	-	Need eliminated
Hanford	62	433	10	38	gas	
Coalinga	-	-	-	-	none	
Reedley	85	136	18	34	none	
Kern Overall	-	-	-	-	-	N/A
Westpark	45	223	8	20	gas	
Kern 70 kV	-	-	-	-	-	Need eliminated
Kern Tevis	-	-	-	-	none	N/A
Kern Oil	130	632	9	100	gas	
South Kern PP	323	2017	10	150	gas	
Big Creek/Ventura Overall	743	3445	19	657	gas	
Vestal	181	851	18	152	hydro	
Santa Clara	157	1256	10	23	gas	
LA Basin Overall	2881	21215	13	1141	gas	
Eastern	838	68232	12	240	gas	
Western	2067	13784	12	1141	gas	
El Nido	269	2001	11	68	gas	
San Diego/Imperial Valley Overall	1585	8564	9	920	gas	
San Diego	1585	8564	9	920	gas	
Border	37	200	8	19	gas	

### J.3.2 Summary of Results by Local Area

Each Local Capacity Area’s overall requirement is determined by also achieving each sub-area requirement. Because these areas are a part of the interconnected electric system, the total for each Local Capacity Area is not simply a summation of the sub-area needs. For example, some sub-areas may overlap and therefore the same units may count for meeting the needs in both sub-areas.

#### J.3.2.1 Humboldt Area

##### J.3.2.1.1 Area Definition:

The transmission tie lines into the area include:

- Bridgeville-Cottonwood 115 kV line #1
- Humboldt-Trinity 115 kV line #1
- Laytonville-Garberville 60 kV line #1
- Trinity-Maple Creek 60 kV line #1

The substations that delineate the Humboldt Area are:

- Bridgeville is in, Low Gap, Wildwood and Cottonwood are out
- Humboldt is in, Trinity is out
- Kekawaka and Garberville are in, Laytonville is out
- Maple Creek is in, Trinity and Ridge Cabin are out

##### J.3.2.1.1.1 Humboldt LCR Area Diagram

Figure J.3.2-1 Humboldt LCR Area

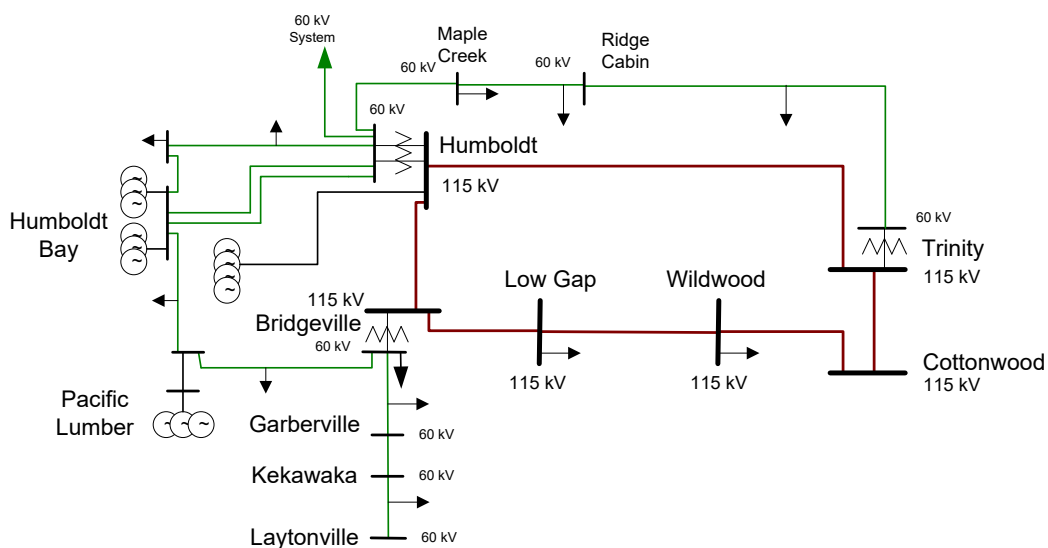

### J.3.2.1.1.2 Humboldt LCR Area Load and Resources

Table J.3.2-1 provides the forecasted load and resources. The list of generators within the LCR area are provided in Attachment A.

In year 2032 the estimated time of local area peak is 19:00 PM.

This area does not contain models of solar resources capable of providing resource adequacy.

If required, all non-solar technology type resources are dispatched at NQC.

Table J.3.2-1 Humboldt LCR Area 2032 Forecast Load and Resources

Load (MW)		Generation (MW)	Aug NQC	At Peak
Gross Load	158	Market, Net Seller, Wind	178	178
AAEE	-3	Battery	15	15
Behind the meter DG	0	MUNI, QF/Self-gen	0	0
<b>Net Load</b>	<b>155</b>	Solar	0	0
Transmission Losses	27	Existing 20-minute Demand Response	0	0
Pumps	0	Mothballed	0	0
<b>Load + Losses + Pumps</b>	<b>182</b>	<b>Total</b>	<b>193</b>	<b>193</b>

### J.3.2.1.1.3 Humboldt LCR Area Hourly Profiles

Figure 3.2-2 illustrates the forecast 2032 profile for the peak day for the Humboldt LCR area along with the Category P6 normal and emergency load serving capabilities without local capacity resources. The chart also includes an estimated amount of energy storage that can be added to this local area from charging restriction perspective and the amount of 4-hour storage that can be added to replace local capacity on a 1 MW for 1 MW basis. Figure 3.2-3 illustrates the forecast 2032 hourly profile for Humboldt LCR area with the Category P6 transmission capability without local capacity resources.

Figure J.3.2-2 Humboldt 2032 Peak Day Forecast Profiles

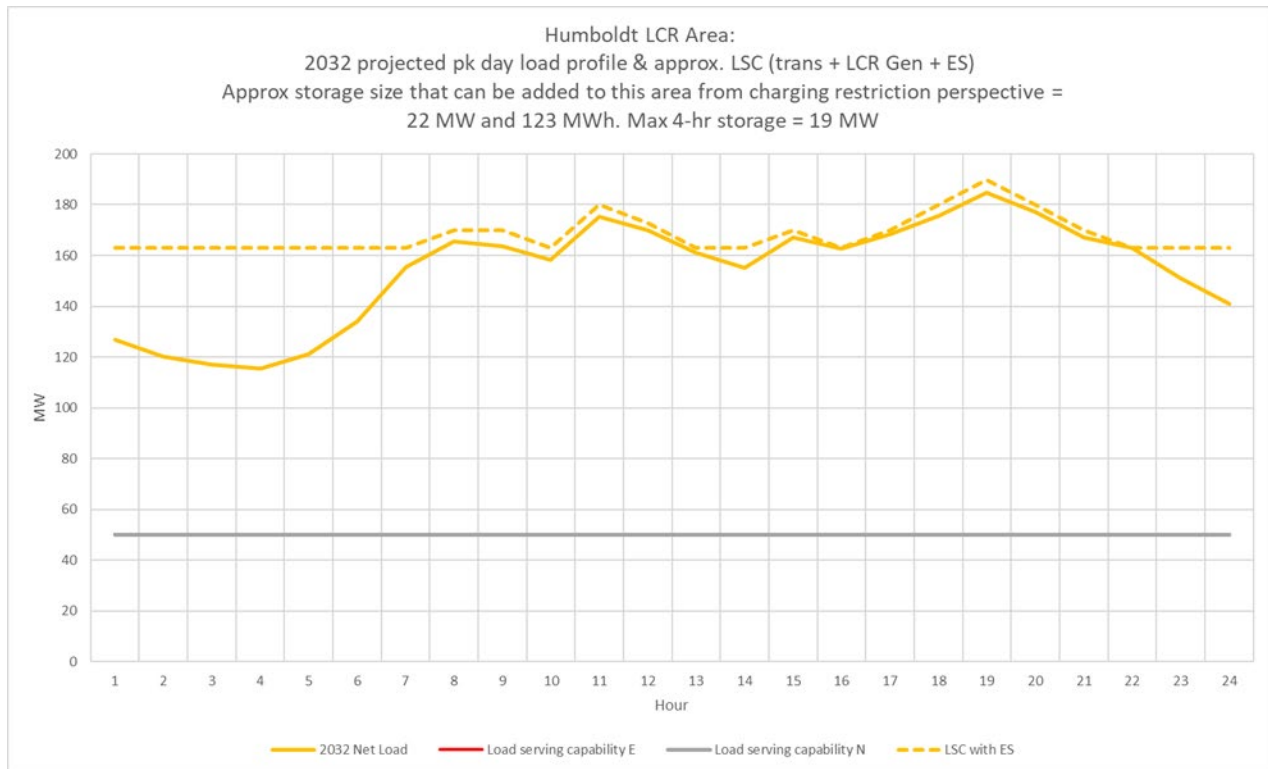
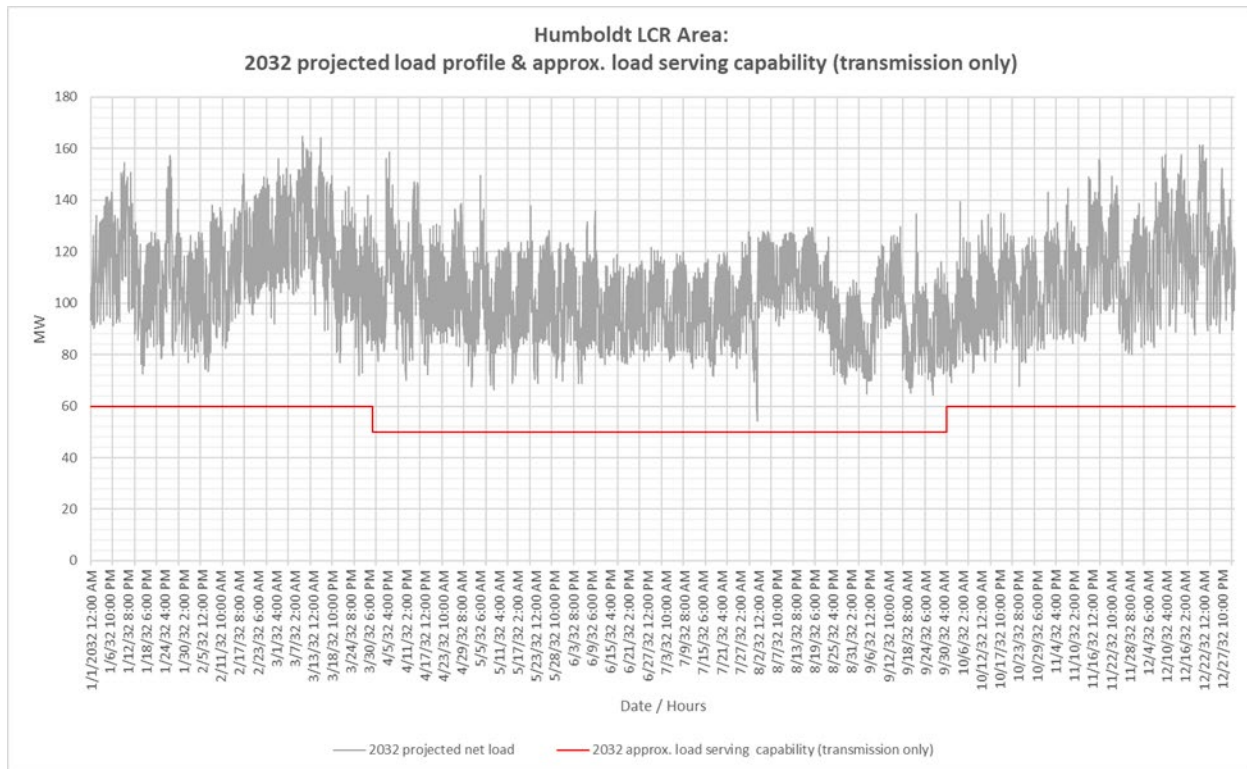

Figure J.3.2-3 Humboldt 2032 Forecast Hourly Profile



**J.3.2.1.1.4 Approved transmission projects included in base cases**

Maple Creek Reactive Support

**J.3.2.1.2 Humboldt Overall LCR Requirement**

Table J.3.2-2 identifies the area LCR requirements. The LCR requirement for Category P6 contingency is 154 MW.

Table J.3.2-2 Humboldt LCR Area Requirements

Year	Limit	Category	Limiting Facility	Contingency	LCR (MW) (Deficiency)
2032	First Limit	P6	Low Voltage	Cottonwood-Bridgeville 115 kV & Humboldt - Humboldt Bay 115 kV	154

**J.3.2.1.2.1 Effectiveness factors:**

For most helpful procurement information please read procedure 2210Z Effectiveness Factors under 7110 stated at: <http://www.caiso.com/Documents/2210Z.pdf>

**J.3.2.1.2.2 Changes compared to the 2027 LCT study:**

Load forecast increased by 2 MW and the total LCR has increased by 7 MW due to load forecast increase and a different limiting facility.

**J.3.2.2 North Coast / North Bay Area****J.3.2.2.1 Area Definition:**

The transmission tie facilities coming into the North Coast/North Bay area are:

- Cortina-Mendocino 115 kV Line
- Cortina-Eagle Rock 115 kV Line
- Willits-Garberville 60 kV line #1
- Vaca Dixon-Lakeville 230 kV line #1
- Tulucay-Vaca Dixon 230 kV line #1
- Lakeville-Sobrante 230 kV line #1
- Ignacio-Sobrante 230 kV line #1

The substations that delineate the North Coast/North Bay area are:

- Cortina is out, Mendocino and Indian Valley are in
- Cortina is out, Eagle Rock, Highlands and Homestake are in
- Willits and Lytonville are in, Kekawaka and Garberville are out
- Vaca Dixon is out, Lakeville is in
- Tuluca y is in, Vaca Dixon is out
- Lakeville is in, Sobrante is out
- Ignacio is in, Sobrante and Crocket are out

**J.3.2.2.1.1 North Coast and North Bay LCR Area Diagram**

Figure J.3.2-4 North Coast and North Bay LCR Area

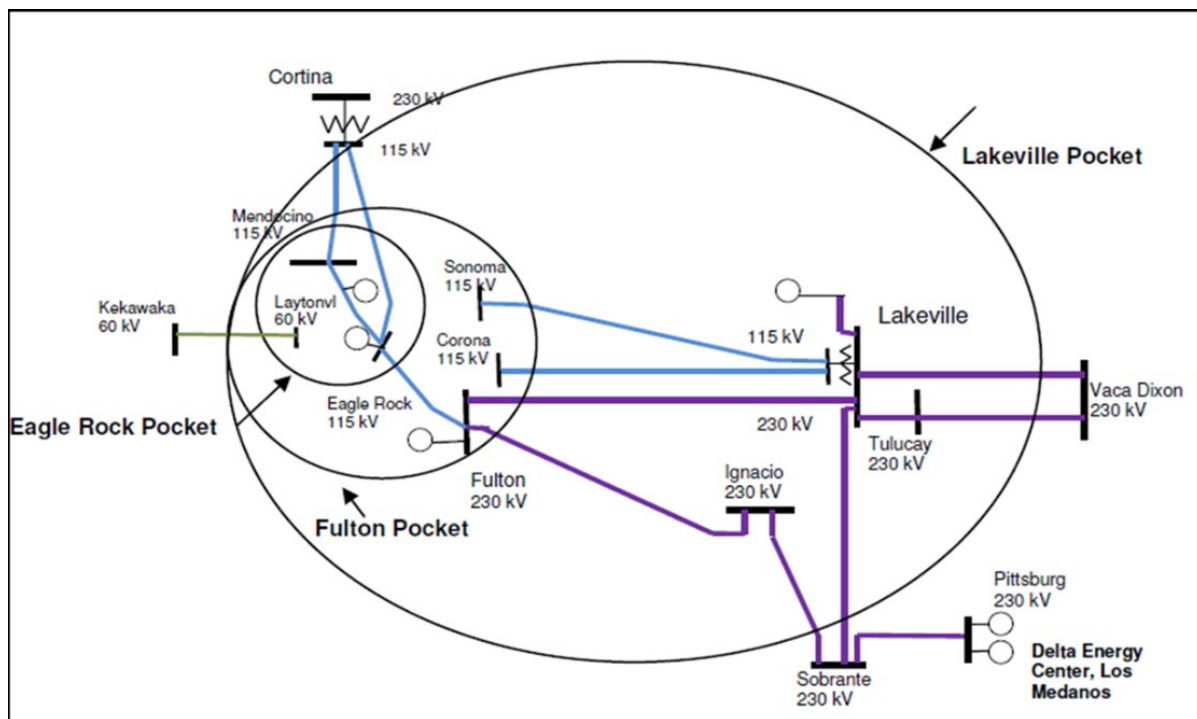

**J.3.2.2.1.2 North Coast and North Bay LCR Area Load and Resources**

Table J.3.2-3 provides the forecasted load and resources. The list of generators within the LCR area are provided in Attachment A.

In year 2032 the estimated time of local area peak is 18:20 PM.

This area does not contain models of solar resources capable of providing resource adequacy.

If required, all non-solar technology type resources are dispatched at NQC.

Table J.3.2-3 North Coast and North Bay LCR Area 2032 Forecast Load and Resources

Load (MW)		Generation (MW)	Aug NQC	At Peak
Gross Load	1812	Market, Net Seller	761	761
AAEE	-13	Battery	0	0
Behind the meter DG	0	MUNI, QF/Self-gen	138	138
<b>Net Load</b>	<b>1799</b>	Solar	0	0
Transmission Losses	45	Existing 20-minute Demand Response	12	12
Pumps	0	Mothballed	0	0
<b>Load + Losses + Pumps</b>	<b>1854</b>	<b>Total</b>	<b>911</b>	<b>911</b>

**J.3.2.2.1.3 North Coast and North Bay LCR Area Hourly Profiles**

Figure J.3.2-5 illustrates the forecast 2032 profile for the peak day for the North Coast/North Bay LCR area along with the Category P3 normal and emergency load serving capabilities without local capacity resources. The chart also includes an estimated amount of energy storage that can be added to this local area from charging restriction perspective and the amount of 4-hour storage that can be added to replace local capacity on a 1 MW for 1 MWh basis. Figure J.3.2-6 illustrates the forecast 2032 hourly profile for North Coast North Bay LCR area with the Category P3 emergency load serving capability without local capacity resources.

Figure J.3.2-5 North Coast and North Bay 2032 Peak Day Forecast Profiles

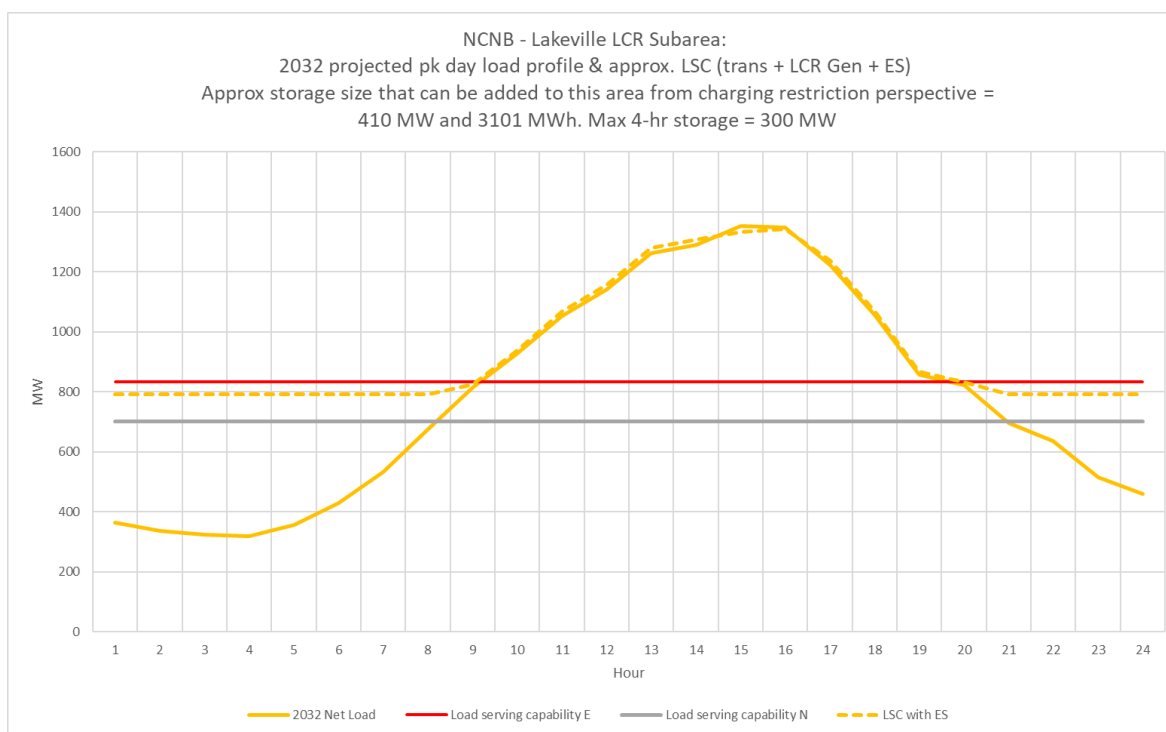
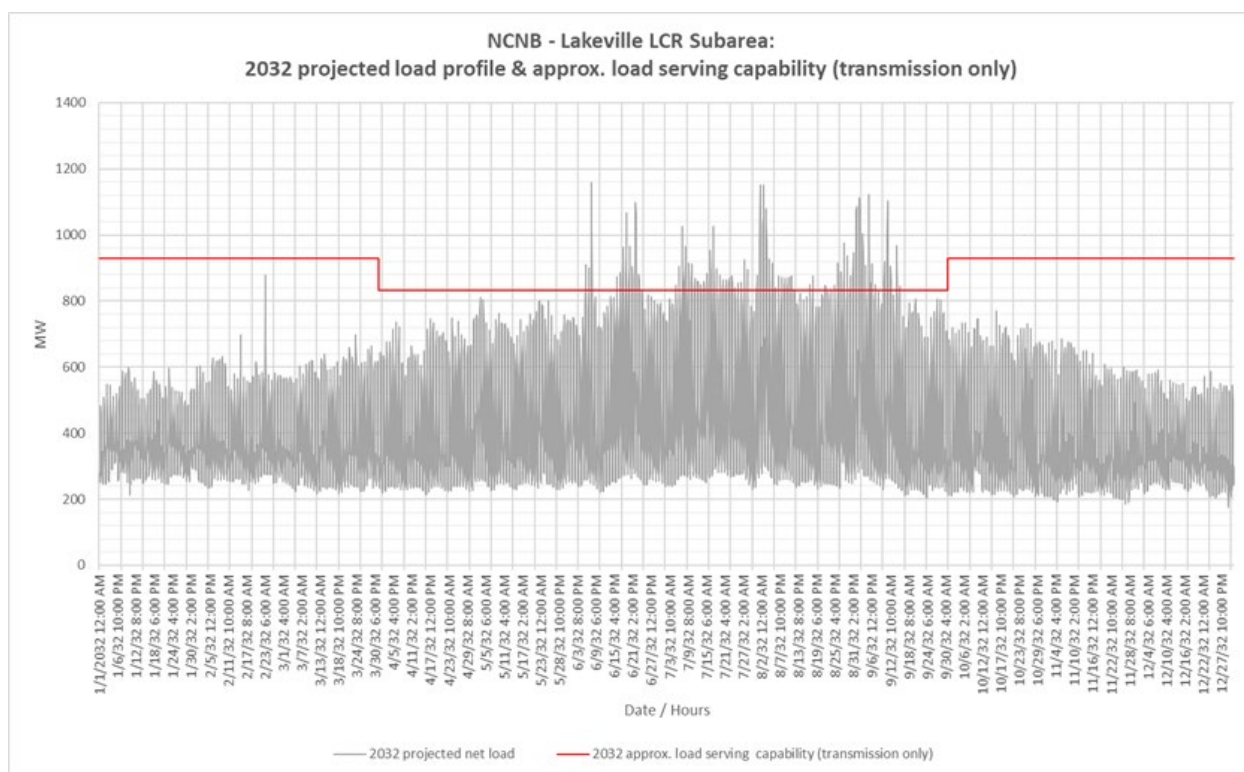

Figure J.3.2-6 North Coast and North Bay 2032 Forecast Hourly Profile



**J.3.2.2.1.4 Approved transmission projects modeled in base cases**

- Vaca Dixon-Lakeville 230 kV Corridor Series Compensation
- Tulucay-Napa #2 60 kV Line Capacity Increase
- Fulton-Hopland 60 kV Line Reconductor
- Clear Lake 60 kV Reinforcement
- Ignacio Area Upgrade
- Lakeville 60 kV Area Reinforcement

**J.3.2.2.2 Eagle Rock LCR Sub-area**

Eagle Rock is a Sub-area of the North Coast and North Bay LCR Area.

**J.3.2.2.2.1 Eagle Rock LCR Sub-area Diagram**



Figure J.3.2-7 Eagle Rock LCR Sub-area

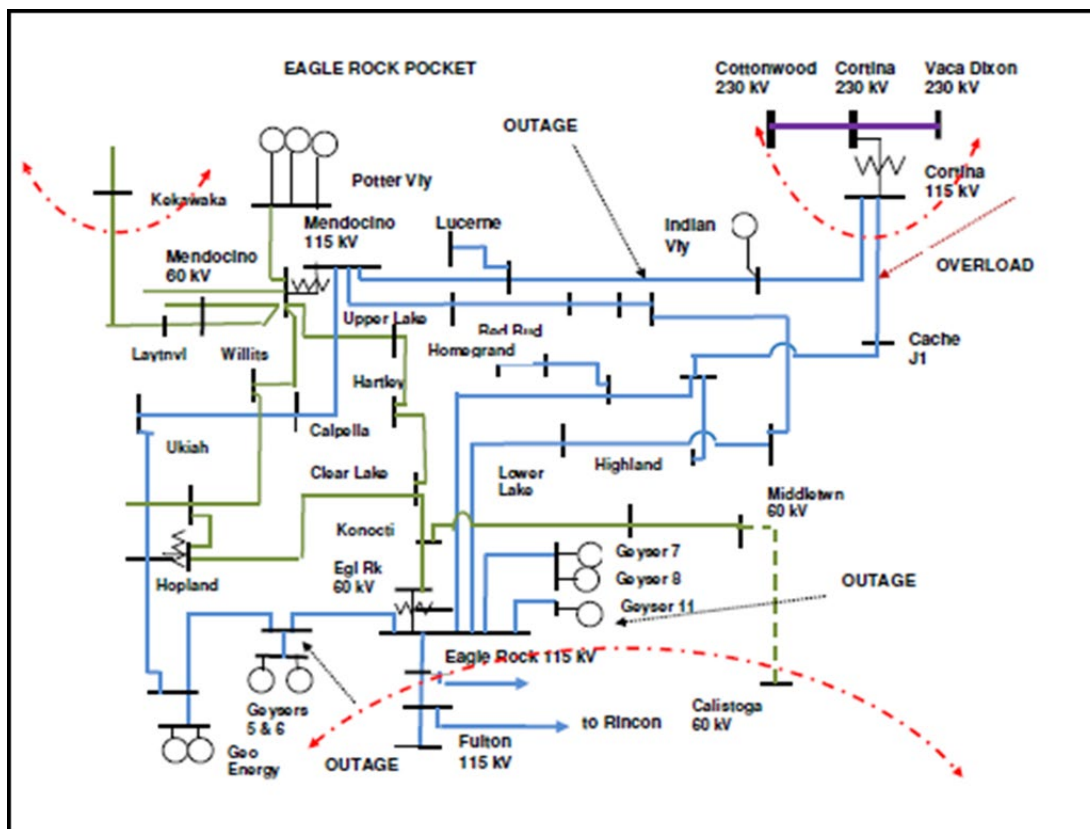

**J.3.2.2.2 Eagle Rock LCR sub-area Load and Resources**

Table J.3.2-4 provides the forecasted load and resources. The list of generators within the LCR sub-area are provided in Attachment A.

Table J.3.2-4 Eagle Rock LCR Area 2032 Forecast Load and Resources

Load (MW)		Generation (MW)	Aug NQC	At Peak
Gross Load	260	Market, Net Seller	275	275
AAEE	-6	Battery	0	0
Behind the meter DG	0	MUNI, QF/Self-gen	2	2
<b>Net Load</b>	<b>254</b>	Solar	0	0
Transmission Losses	15	Existing 20-minute Demand Response	0	0
Pumps	0	Mothballed	0	0
<b>Load + Losses + Pumps</b>	<b>269</b>	<b>Total</b>	<b>277</b>	<b>277</b>

### J.3.2.2.3 Eagle Rock LCR Sub-area Hourly Profiles

Figure J.3.2-8 illustrates the forecast 2032 profile for the peak day for the Eagle Rock LCR Sub-area with the Category P3 normal and emergency load serving capabilities without local capacity resources. The chart also includes an estimated amount of energy storage that can be added to this local area from charging restriction perspective and the amount of 4-hour storage that can be added to replace local capacity on a 1 MW for 1 MW basis. Figure J.3.2-9 illustrates the forecast 2032 hourly profile for Eagle Rock LCR sub-area with the Category P3 emergency load serving capability without local capacity resources.

Figure J.3.2-8 Eagle Rock LCR Sub-area 2032 Peak Day Forecast Profiles

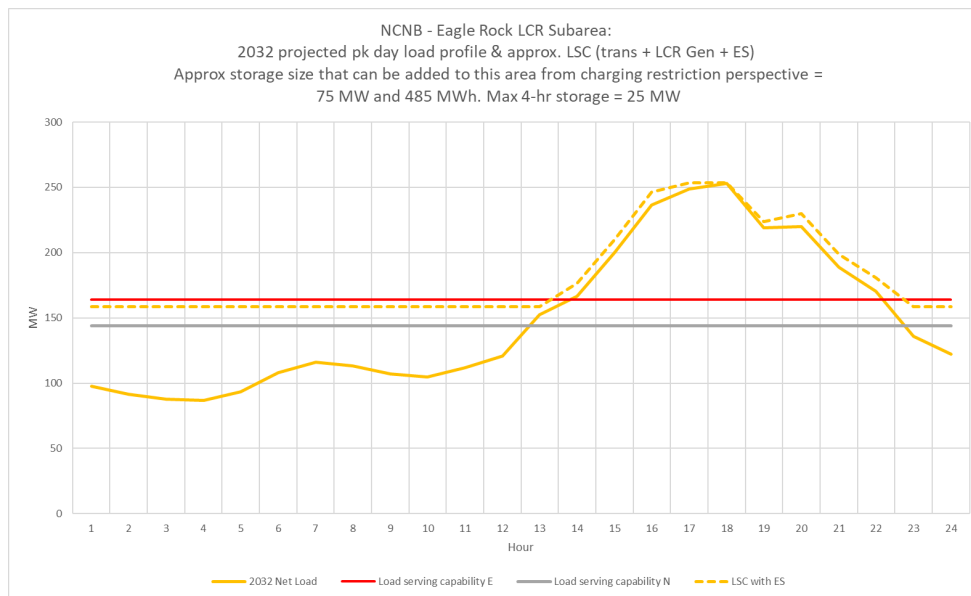
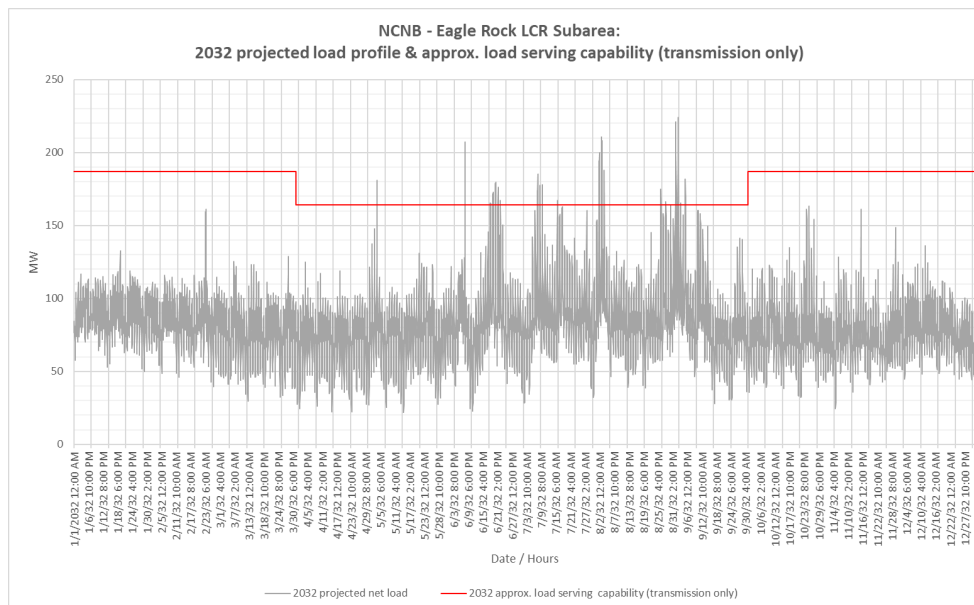

Figure J.3.2-9 Eagle Rock LCR Sub-area 2032 Forecast Hourly Profiles



**J.3.2.2.4 Eagle Rock LCR Sub-area Requirement**

Table J.3.2-5 identifies the sub-area LCR requirements. The LCR requirement for Category P6 contingency is 257 MW.

Table J.3.2-5 Eagle Rock LCR Sub-area Requirements

Year	Limit	Category	Limiting Facility	Contingency	LCR (MW) (Deficiency)
2032	First Limit	P3	Eagle Rock-Cortina 115 kV line	Cortina-Mendocino 115 kV with Geysers #11 unit out	257

**J.3.2.2.5 Effectiveness factors:**

Effectiveness factors for generators in the Eagle Rock LCR Sub-area are in Attachment B table titled [Eagle Rock](#).

For most helpful procurement information please read procedure 2210Z Effectiveness Factors under 7120 posted at: <http://www.caiso.com/Documents/2210Z.pdf>

**J.3.2.2.3 Fulton Sub-area**

Fulton is a sub-area of the North Coast and North Bay LCR Area.

**J.3.2.2.3.1 Eagle Rock LCR Sub-area Diagram**

Figure J.3.2-10 Fulton LCR Sub-area

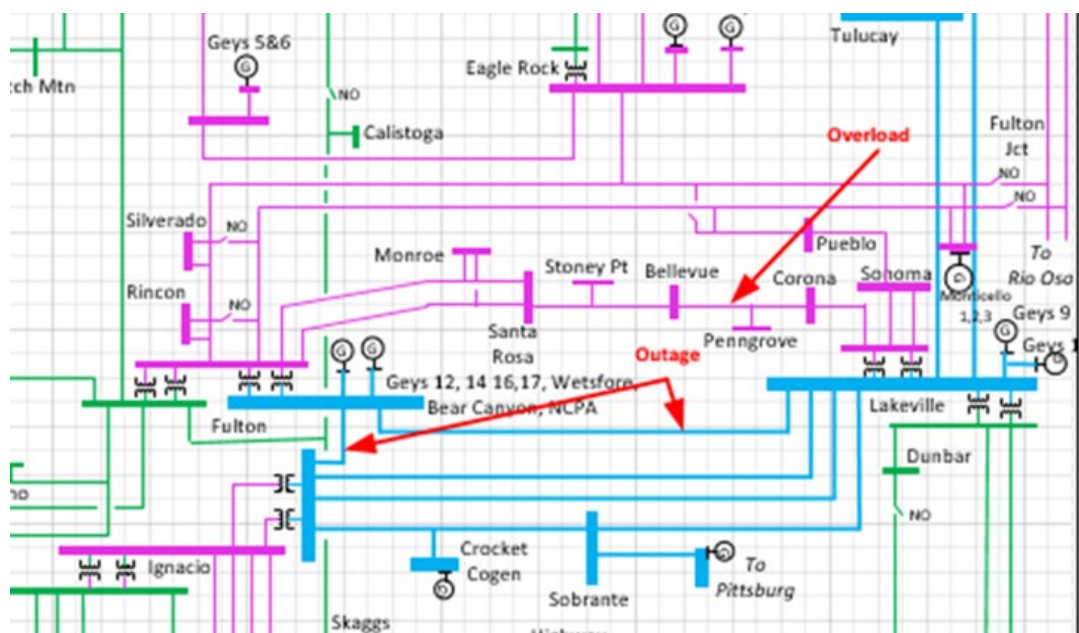

**J.3.2.2.3.2 Fulton LCR sub-area Load and Resources**

Table J.3.2-4 provides the forecasted load and resources. The list of generators within the LCR sub-area are provided in Attachment A.

Table J.3.2-6 Fulton LCR Area 2032 Forecast Load and Resources

Load (MW)		Generation (MW)	Aug NQC	At Peak
Gross Load	911	Market, Net Seller	487	487
AAEE	-13	Battery	0	0
Behind the meter DG	0	MUNI, QF/Self-gen	59	59
<b>Net Load</b>	<b>898</b>	Solar	0	0
Transmission Losses	37	Existing 20-minute Demand Response	0	0
Pumps	0	Mothballed	0	0
<b>Load + Losses + Pumps</b>	<b>935</b>	<b>Total</b>	<b>546</b>	<b>546</b>

**J.3.2.2.3.3 Fulton LCR Sub-area Hourly Profiles**

Figure J.3.2-11 illustrates the forecast 2032 profile for the peak day for the Fulton LCR Sub-area with the Category P3 normal and emergency load serving capabilities without local capacity resources. The chart also includes an estimated amount of energy storage that can be added to this local area from charging restriction perspective and the amount of 4-hour storage that can be added to replace local capacity on a 1 MW for 1 MW basis.

Figure J.3.2-12 illustrates the forecast 2032 hourly profile for Fulton LCR sub-area with the Category P3 emergency load serving capability without local capacity resources.

Figure J.3.2-11 Fulton LCR Sub-area 2032 Peak Day Forecast Profiles

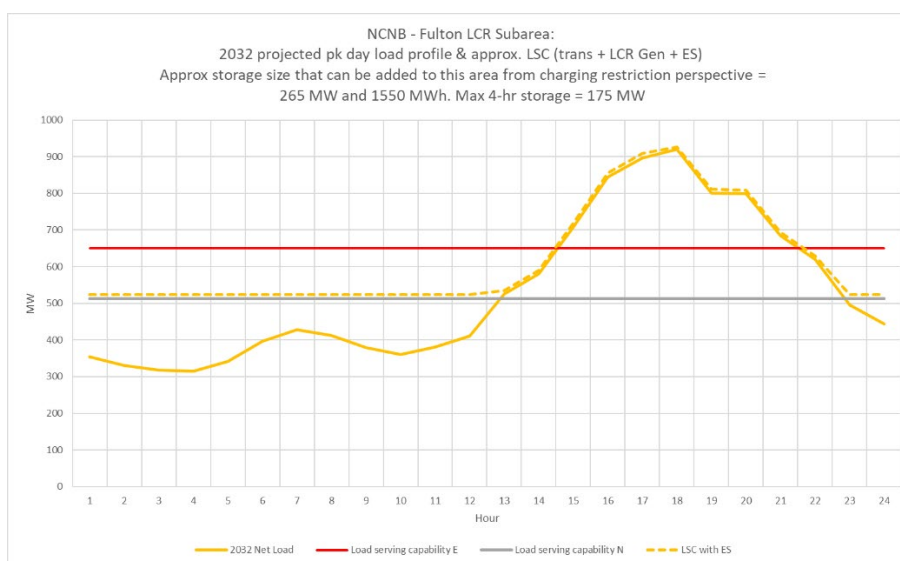
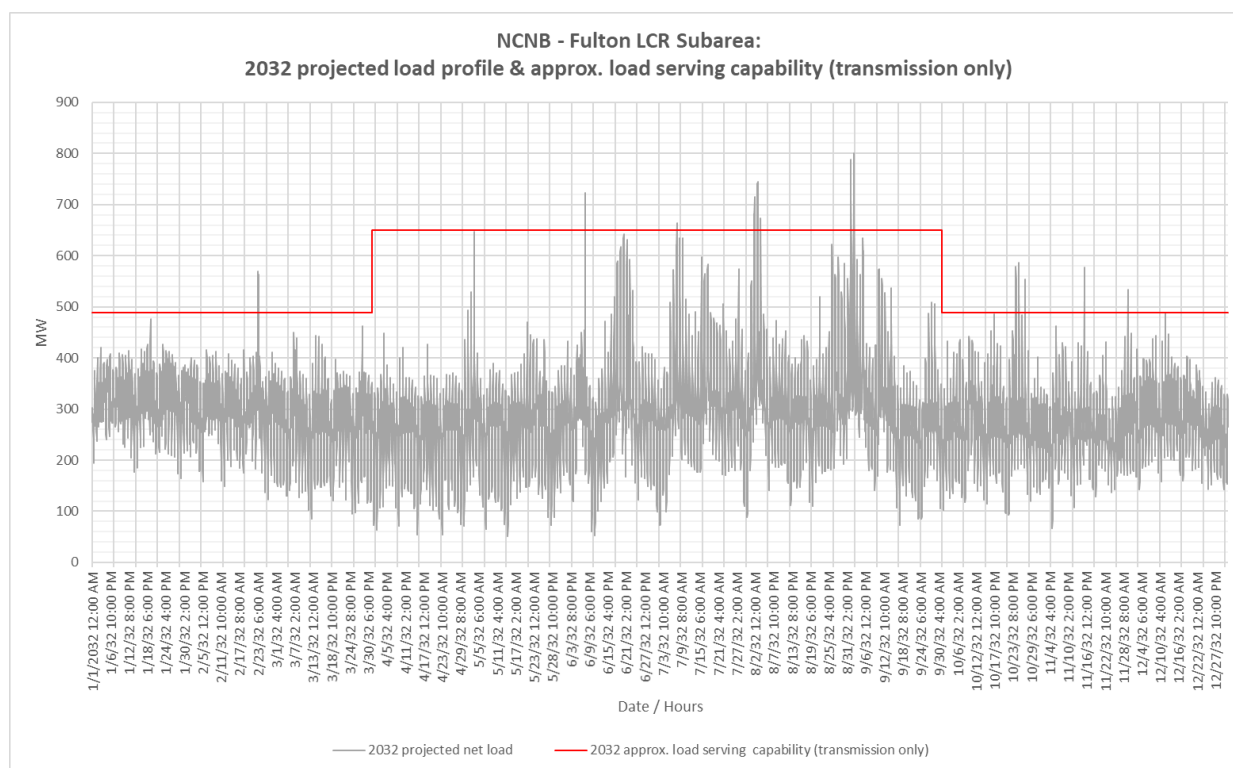

Figure J.3.2-12 Fulton LCR Sub-area 2032 Forecast Hourly Profiles



**J.3.2.2.3.4 Fulton LCR Sub-area Requirement**

Table J.3.2-7 identifies the sub-area LCR requirements. The LCR requirement for Category P6 contingency is 380 MW.

Table J.3.2-7 Fulton LCR Sub-area Requirements

Year	Limit	Category	Limiting Facility	Contingency	LCR (MW) (Deficiency)
2032	First Limit	P6	Corona-Penngrove 115kV Line	Fulton-Lakeville and Fulton-Ignacio 230 kV lines	380

**J.3.2.2.3.5 Effectiveness factors:**

Effectiveness factors for generators in the Fulton LCR Sub-area are in Attachment B table titled [Fulton](#).

For most helpful procurement information please read procedure 2210Z Effectiveness Factors under 7120 posted at: <http://www.caiso.com/Documents/2210Z.pdf>

**J.3.2.2.4 North Coast and North Bay Overall****J.3.2.2.4.1 North Coast and North Bay Overall Requirement**

Table J.3.2-8 identifies the sub-area LCR requirements. The LCR requirement for Category P3 contingency are 1018 MW including a 107 MW deficiency.

Table J.3.2-8 North Coast and North Bay LCR area Requirements

Year	Limit	Category	Limiting Facility	Contingency	LCR (MW) (Deficiency)
2030	First Limit	P3	Vaca Dixon-Lakeville 230 kV	Vaca Dixon-Tulucay 230 kV with DEC power plant out of service	1018 (107)

**J.3.2.2.4.2 Effectiveness factors:**

Effectiveness factors for generators in the North Coast and North Bay LCR area are in Attachment B table titled [Lakeville](#).

**J.3.2.2.4.3 Changes compared to the 2027 LCT study:**

Overall the load forecast went up by 333 MW compared to 2027. The overall LCR requirement (deficiency) went down by 7 MW as a result of a change in load distribution and transmission projects in the Bay Area.

**J.3.2.3 Sierra Area****J.3.2.3.1 Area Definition:**

The transmission tie lines into the Sierra Area are:

Table Mountain-Rio Oso 230 kV line

Table Mountain-Palermo 230 kV line

Table Mt-Pease 60 kV line

Caribou-Palermo 115 kV line

Drum-Summit 115 kV line #1

Drum-Summit 115 kV line #2

Spaulding-Summit 60 kV line

Brighton-Bellota 230 kV line

- Rio Oso-Lockeford 230 kV line
- Gold Hill-Eight Mile Road 230 kV line
- Lodi-Eight Mile Road 230 kV line
- Gold Hill-Lake 230 kV line

The substations that delineate the Sierra Area are:

- Table Mountain is out Rio Oso is in
- Table Mountain is out Palermo is in
- Table Mt is out Pease is in
- Caribou is out Palermo is in
- Drum is in Summit is out
- Drum is in Summit is out
- Spaulding is in Summit is out
- Brighton is in Bellota is out
- Rio Oso is in Lockeford is out
- Gold Hill is in Eight Mile is out
- Lodi is in Eight Mile is out
- Gold Hill is in Lake is out

**J.3.2.3.1.1 Sierra LCR Area Diagram**

Figure J.3.2-13 Sierra LCR Area

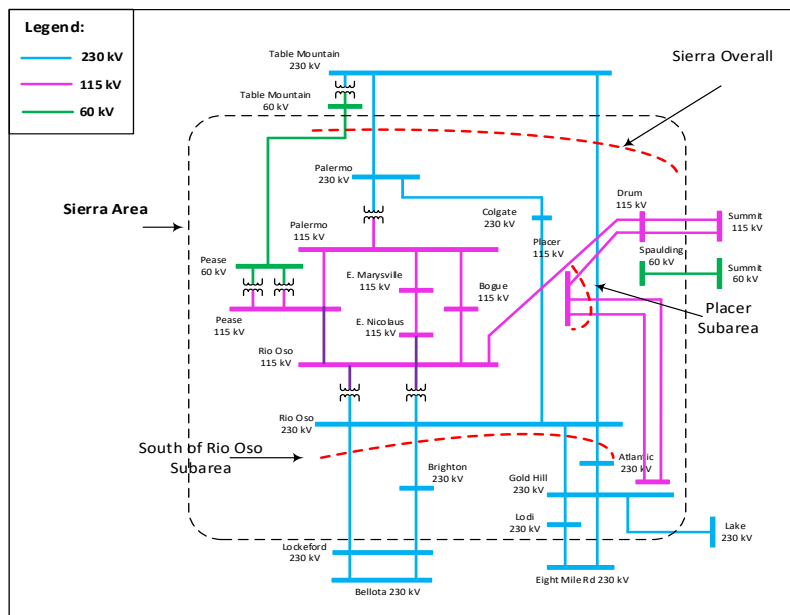

**J.3.2.3.1.2 Sierra LCR Area Load and Resources**

Table J.3.2-9 provides the forecasted load and resources. The list of generators within the LCR area are provided in Attachment A.

In year 2032 the estimated time of local area peak is 19:30 PM.

At the local area peak time the estimated, ISO metered, solar output is 0.00%.

If required, all non-solar technology type resources are dispatched at NQC.

Table J.3.2-9 Sierra LCR Area 2032 Forecast Load and Resources

Load (MW)		Generation (MW)	Aug NQC	At Peak
Gross Load	2035	Market, Net Seller	735	735
AAEE	-14	Battery	0	0
Behind the meter DG	0	MUNI, QF	1206	1206
<b>Net Load</b>	<b>2021</b>	Solar	5	0
Transmission Losses	83	Existing 20-minute Demand Response	0	0
Pumps	0	Mothballed	0	0
<b>Load + Losses + Pumps</b>	<b>2104</b>	<b>Total</b>	<b>1946</b>	<b>1941</b>

**J.3.2.3.1.3 Approved transmission projects modeled:**

Rio Oso #1 and #2 230/115 kV transformer replacement

South of Palermo 115 kV Reinforcement

Vaca-Davis Area Reinforcement

Rio Oso Area 230 kV Voltage Support

East Marysville 115/60 kV

Gold Hill 230/115 kV Transformer Addition

Atlantic 230/60 kV transformer voltage regulator

**J.3.2.3.2 Placer Sub-area**

Placer is a sub-area of the Sierra LCR area.



**J.3.2.3.2.1 Placer LCR Sub-area Diagram**

Figure J.3.2-14 Placer LCR Sub-area

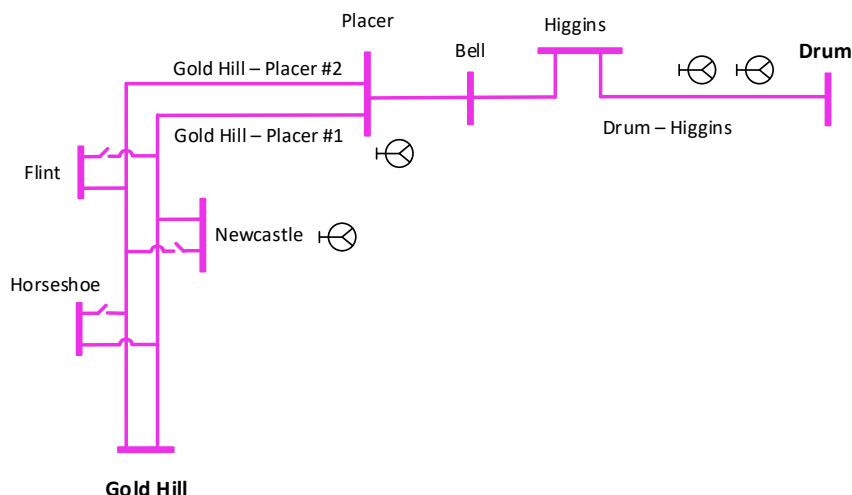

**J.3.2.3.2.2 Placer LCR Sub-area Load and Resources**

Table J.3.2-10 provides the forecasted load and resources. The list of generators within the LCR sub-area are provided in Attachment A.

Table J.3.2-10 Placer LCR Sub-area 2032 Forecast Load and Resources

Load (MW)		Generation (MW)	Aug NQC	At Peak
Gross Load	194	Market, Net Seller	64	64
AAEE	-1	Battery	0	0
Behind the meter DG	0	MUNI, QF	27	27
<b>Net Load</b>	<b>193</b>	Solar	0	0
Transmission Losses	4	Existing 20-minute Demand Response	0	0
Pumps	0	Mothballed	0	0
<b>Load + Losses + Pumps</b>	<b>197</b>	<b>Total</b>	<b>91</b>	<b>91</b>

**J.3.2.3.2.3 Placer LCR Sub-area Hourly Profiles**

Figure J.3.2-15 illustrates the forecast 2032 profile for the peak day for the Placer LCR sub-area with the Category P6 normal and emergency capabilities without local capacity resources. The chart also includes an estimated amount of energy storage that can be added to this local area from charging restriction perspective and the amount of 4-hour storage that can be added to replace local capacity on a 1 MW for 1 MW basis. Figure J.3.2-16 illustrates the forecast 2032 hourly profile for Placer LCR sub-area with the Category P6 emergency load serving capability without local capacity resources.

Figure J.3.2-15 Placer LCR Sub-area 2032 Peak Day Forecast Profiles

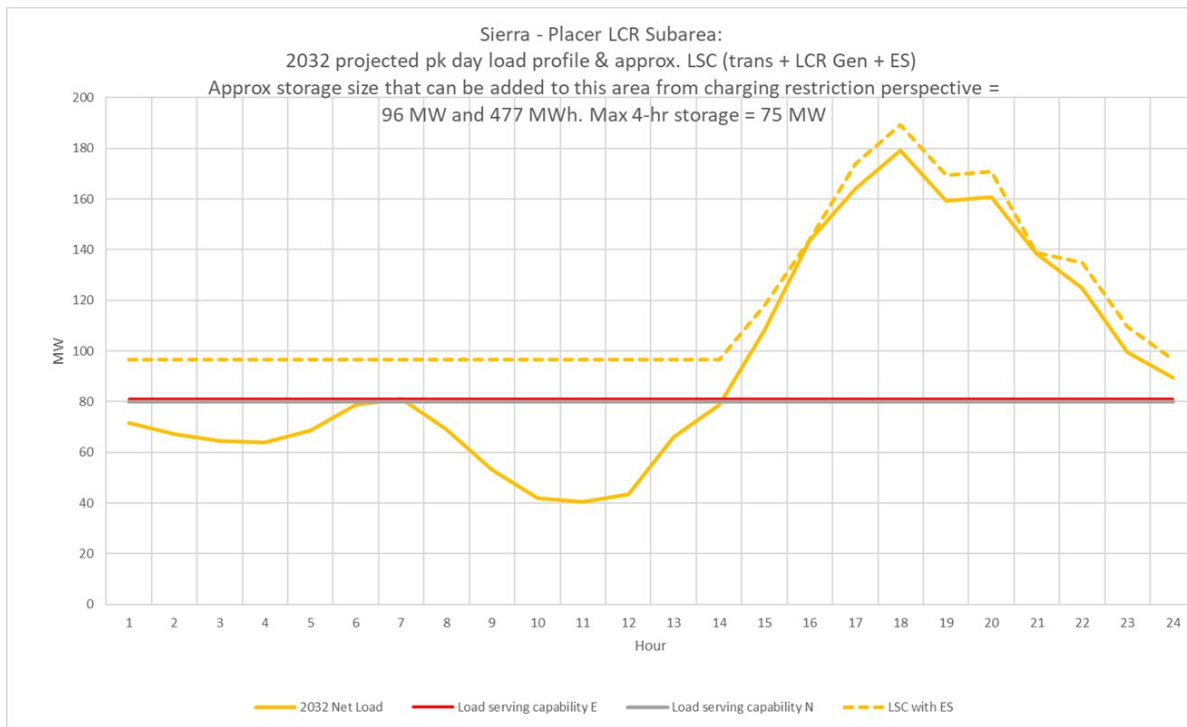
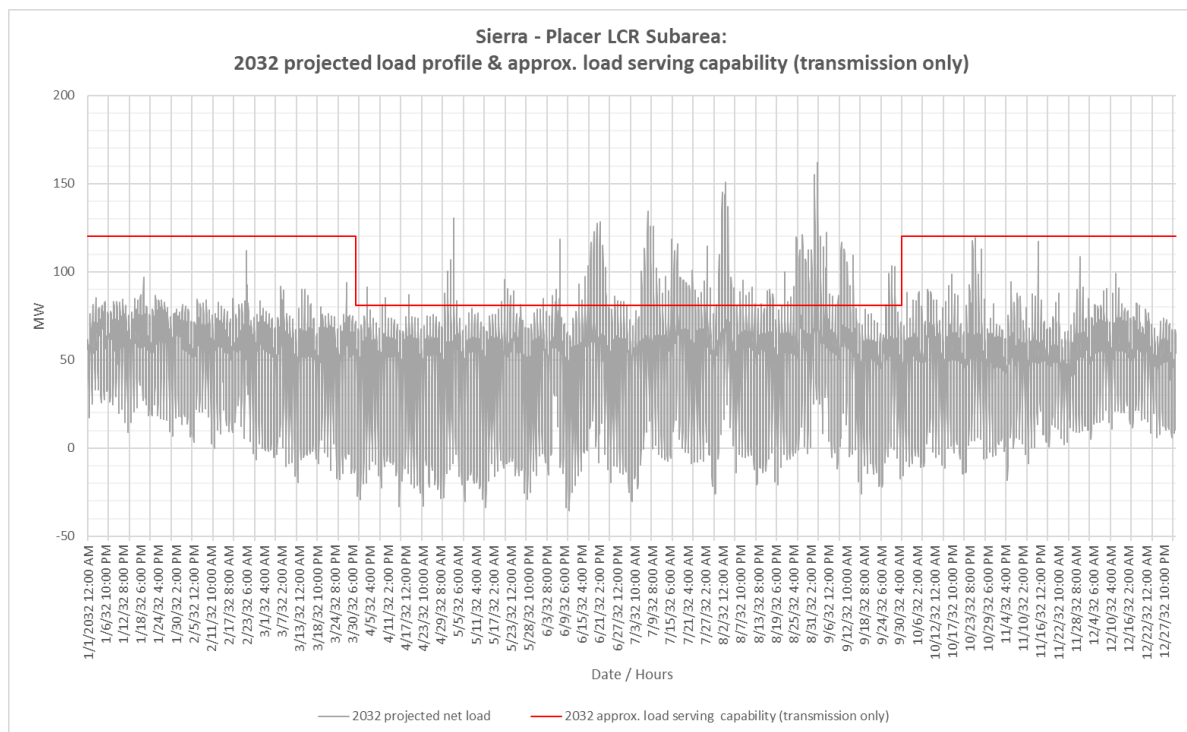

Figure J.3.2-16 Placer LCR Sub-area 2032 Forecast Hourly Profiles



**J.3.2.3.2.4 Placer LCR Sub-area Requirement**

Table J.3.2-11 identifies the sub-area LCR requirements. The LCR requirement for Category P6, P7 contingency is 168 MW, including 77 MW of deficiency.

Table J.3.2-11 Placer LCR Sub-area Requirements

Year	Limit	Category	Limiting Facility	Contingency	LCR (MW) (Deficiency)
2032	First Limit	P6, P7	Drum – Higgins 115 kV line	Gold Hill – Placer #1 and #2 115 kV lines	168 (77)

**J.3.2.3.2.5 Effectiveness factors**

All units within the Placer Sub-area have the same effectiveness factor.

For most helpful procurement information please read procedure 2210Z Effectiveness Factors under 7240 posted at: <http://www.caiso.com/Documents/2210Z.pdf>

**J.3.2.3.3 Pease Sub-area**

Pease is a sub-area of the Sierra LCR area.

Pease sub-area will be eliminated due to the East Marysville 115/60 kV transmission project

**J.3.2.3.4 Drum-Rio Oso Sub-area**

Drum-Rio Oso is a sub-area of the Sierra LCR area.

Drum-Rio Oso sub-area will be eliminated due to the Rio Oso 230/115 kV transformer upgrade transmission project.

**J.3.2.3.5 Gold Hill-Drum Sub-area**

Gold Hill-Drum is a sub-area of the Sierra LCR area.

Gold Hill-Drum sub-area will be eliminated due to the Gold Hill 230/115 kV Transformer Addition transmission project.

**J.3.2.3.6 South of Rio Oso Sub-area**

South of Rio Oso is a sub-area of the Sierra LCR area.

**J.3.2.3.6.1 South of Rio Oso LCR Sub-area Diagram**

Figure J.3.2-17 Pease LCR Sub-area

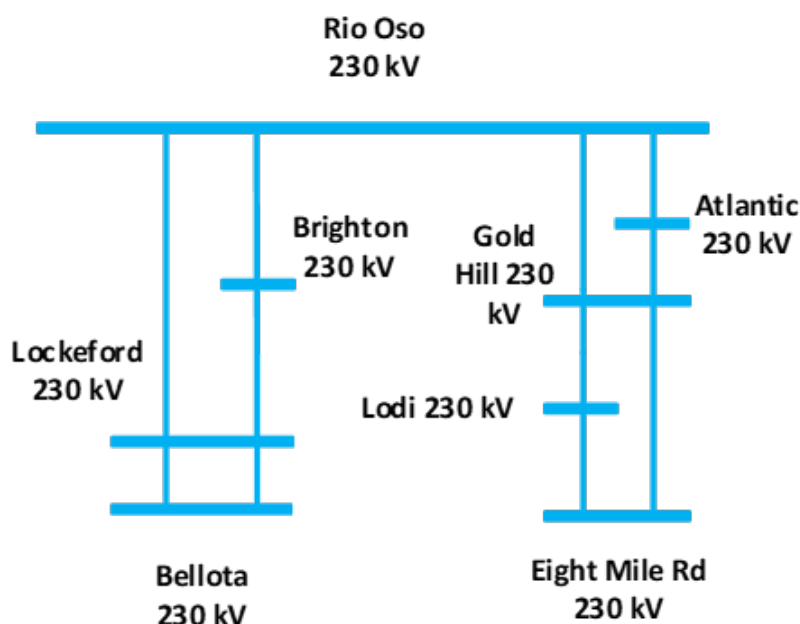

**J.3.2.3.6.2 South of Rio Oso LCR Sub-area Load and Resources**

The South of Rio Oso sub-area does not have a defined load pocket with the limits based upon power flow through the area. Table J.3.2-12 provides the forecasted resources in the sub-area. The list of generators within the LCR area are provided in Attachment A.

Table J.3.2-12 South of Rio Oso LCR Sub-area 2032 Forecast Load and Resources

Load (MW)	Generation (MW)	Aug NQC	At Peak
The South of Rio Oso Sub-area does not have a defined load pocket with the limits based upon power flow through the area.	Market, Net Seller	111	111
	Battery	606	606
	MUNI, QF	0	0
	LTPP Preferred Resources	0	0
	Existing 20-minute Demand Response	0	0
	Mothballed	0	0
	<b>Total</b>	<b>717</b>	<b>717</b>

**J.3.2.3.6.3 South of Rio Oso LCR Sub-area Hourly Profiles**

The South of Rio Oso Sub-area does not have a defined load pocket with the limits based upon power flow through the area. As such, no load profile is provided for this sub-area.

**J.3.2.3.6.4 South of Rio Oso LCR Sub-area Requirement**

Table J.3.2-13 identifies the sub-area LCR requirements. The LCR requirements for Category P6 contingency is 261 MW.

Table J.3.2-13 South of Rio Oso LCR Sub-area Requirements

Year	Limit	Category	Limiting Facility	Contingency	LCR (MW) (Deficiency)
2032	First limit	P6	Rio Oso – Atlantic 230 kV	Rio Oso – Gold Hill 230 kV Rio Oso – Brighton 230 kV	261

**J.3.2.3.6.5 Effectiveness factors:**

Effectiveness factors for generators in the South of Rio Oso LCR Sub-area are in Attachment B table titled [Rio Oso](#).

For other helpful procurement information please read procedure 2210Z Effectiveness Factors under 7230 posted at: <http://www.caiso.com/Documents/2210Z.pdf>

**J.3.2.3.7 South of Palermo Sub-area**

South of Palermo is a sub-area of the Sierra LCR area.

South of Palermo sub-area will be eliminated due to the South of Palermo transmission project.

**J.3.2.3.8 Sierra Area Overall****J.3.2.3.8.1 Sierra LCR Area Hourly Profiles**

The Sierra LCR Area limits are based upon power flow through the area. As such, no load profile is provided for the area.

**J.3.2.3.8.2 Sierra LCR Area Requirement**

Table J.3.2-14 identifies the area requirements. The LCR requirement for Category P6 contingency is 1450 MW.

Table J.3.2-14 Sierra Area Requirements

Year	Limit	Category	Limiting Facility	Contingency	LCR (MW) (Deficiency)
2032	First limit	P6, P7	Table Mountain – Pease 60 kV	Table Mountain – Palermo 230 kV Table Mountain – Rio Oso 230 kV	1450

**J.3.2.3.8.3 Effectiveness factors:**

Effectiveness factors for generators in the Sierra overall area are in Attachment B table titled [Sierra Overall](#).

For other helpful procurement information please read procedure 2210Z Effectiveness Factors under 7230 and 7240 posted at: <http://www.caiso.com/Documents/2210Z.pdf>

#### **J.3.2.3.8.4 Changes compared to the 2027 LCT study:**

The load forecast went up by 203 MW. The total LCR need has increased by 105 MW mostly due to increase in load forecast.

#### **J.3.2.4 Stockton Area**

The LCR requirement for the Stockton Area is driven by the requirements for the Tesla-Bellota.

##### **J.3.2.4.1 Area Definition:**

###### *Tesla-Bellota Sub-Area Definition*

The transmission facilities that establish the boundary of the Tesla-Bellota sub-area are:

Bellota 230/115 kV Transformer #1

Bellota 230/115 kV Transformer #2

Tesla-Tracy 115 kV Line

Tesla-Salado 115 kV Line

Tesla-Salado-Manteca 115 kV line

Tesla-Schulte #1 115 kV Line

Tesla-Schulte #2 115kV line

Tesla-Vierra 115 kV Line

The substations that delineate the Tesla-Bellota Sub-area are:

Bellota 230 kV is out Bellota 115 kV is in

Bellota 230 kV is out Bellota 115 kV is in

Tesla is out Tracy is in

Tesla is out Salado is in

Tesla is out Salado and Manteca are in

Tesla is out Schulte is in

Tesla is out Schulte is in

Tesla is out Thermal Energy is in

**J.3.2.4.1.1 Stockton LCR Area Diagram**

The Stockton LCR Area is comprised of the individual noncontiguous Sub-areas with diagrams provided for each of the Sub-areas below.

**J.3.2.4.1.2 Stockton LCR Area Load and Resources**

Table J.3.2-15 provides the forecast load and resources in the area. The list of generators within the LCR area are provided in Attachment A.

In year 2032 the estimated time of local area peak is 19:30 PM.

At the local area peak time the estimated, ISO metered, solar output is 0.00%.

If required, all non-solar technology type resources are dispatched at NQC.

Table J.3.2-15 Stockton LCR Area 2032 Forecast Load and Resources

Load (MW)		Generation (MW)	NQC	At Peak
Gross Load	1033	Market, Net Seller	475	475
AAEE	-5	Battery	152	152
Behind the meter DG	0	MUNI, QF	112	112
<b>Net Load</b>	<b>1028</b>	Solar	16	0
Transmission Losses	22	Existing 20-minute Demand Response	0	0
Pumps	0	Mothballed	0	0
<b>Load + Losses + Pumps</b>	<b>1050</b>	<b>Total</b>	<b>755</b>	<b>739</b>

**J.3.2.4.1.3 Stockton LCR Area Hourly Profiles**

The Stockton LCR Area is comprised of the individual noncontiguous sub-areas with profiles provided for each of the sub-areas below.

**J.3.2.4.1.4 Approved transmission projects modeled**

Vierra 115 kV Looping Project

Lockeford-Lodi Area 230 kV Development

Mosher Transmission Project

Tesla 230 kV Bus Series Reactor

Kasson – Kasson Junction 1 115 kV Line Section Reconductoring Project

Manteca #1 60 kV Line Section Reconductoring Project

Manteca-Ripon-Riverbank-Melones Area 115 kV Line Reconductoring Project

Weber-Mormon Jct Line Section Reconductoring Project

**J.3.2.4.2 Weber Sub-area**

Weber sub-area has been eliminated due to change in LCR criteria.

**J.3.2.4.3 Lockeford Sub-area**

Lockeford sub-area will be eliminated due to the Lockeford-Lodi Area 230 kV Development transmission project.

**J.3.2.4.4 Stanislaus Sub-area**

Stanislaus is a sub-area of the Stockton LCR area.

**J.3.2.4.4.1 Stanislaus LCR Sub-area Diagram**

Figure J.3.2-18 Stanislaus LCR Sub-area

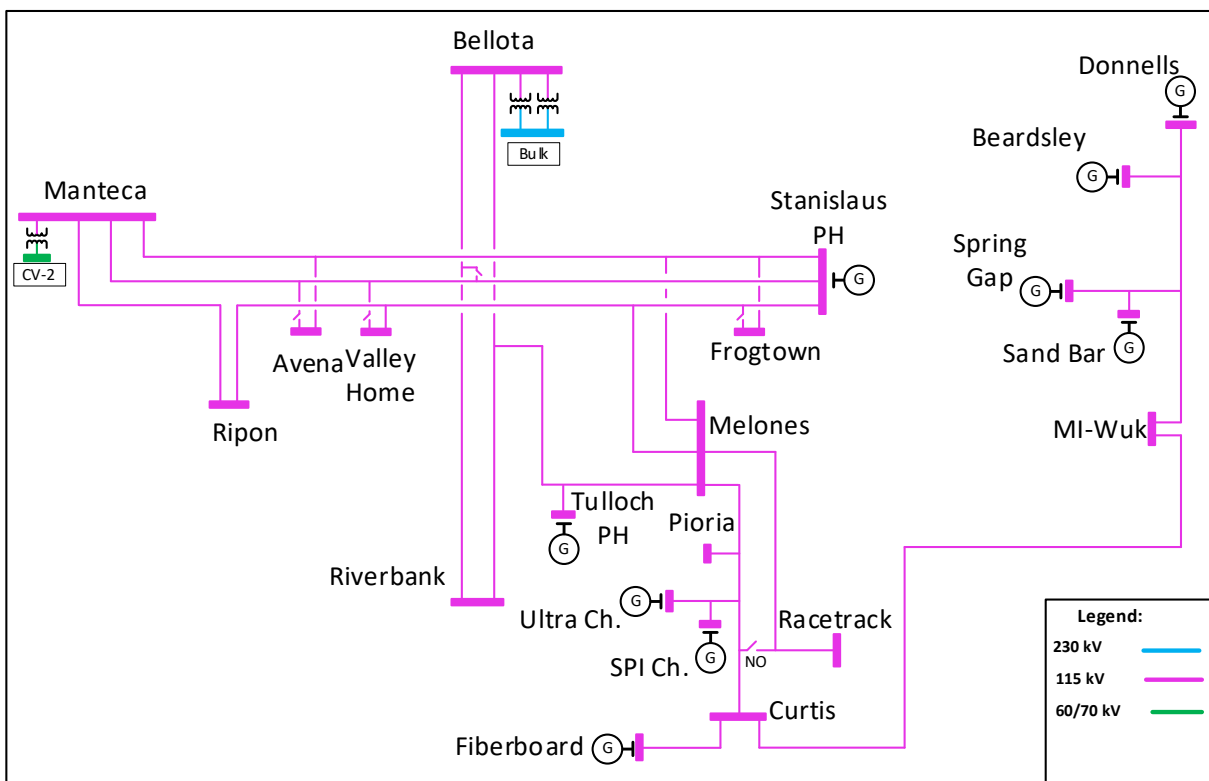

**J.3.2.4.4.2 Stanislaus LCR Sub-area Load and Resources**

The Stanislaus sub-area does not have a defined load pocket with the limits based upon power flow through the area. Table J.3.2-16 provides the forecasted resources in the sub-area. The list of generators within the LCR sub-area are provided in Attachment A.



Table J.3.2-16 Stanislaus LCR Sub-area 2032 Forecast Load and Resources

Load (MW)	Generation (MW)	Aug NQC	At Peak
The Stanislaus Sub-area does not has a defined load pocket with the limits based upon power flow through the area.	Market, Net Seller	101	101
	Battery	132	132
	MUNI, QF	91	91
	Solar	0	0
	Existing 20-minute Demand Response	0	0
	Mothballed	0	0
	<b>Total</b>	<b>324</b>	<b>324</b>

#### J.3.2.4.4.3 Stanislaus LCR Sub-area Hourly Profiles

The Stanislaus sub-area does not has a defined load pocket with the limits based upon power flow through the area. As such, no load profile is provided for this sub-area.

#### J.3.2.4.4.4 Stanislaus LCR Sub-area Requirement

Table J.3.2-17 identifies the sub-area requirements. The LCR requirement for Category P3 contingency is 204 MW.

Table J.3.2-17 Stanislaus LCR Sub-area Requirements

Year	Limit	Category	Limiting Facility	Contingency	LCR (MW) (Deficiency)
2032	First limit	P3	Vierra – Manteca 115 kV	Stanislaus - Melones SW STA-Manteca 115 kV Line and Stanislaus PH	204

#### J.3.2.4.4.5 Effectiveness factors:

All units within the Stanislaus Sub-area have the same effectiveness factor.

For most helpful procurement information please read procedure 2210Z Effectiveness Factors under 7410 posted at: <http://www.caiso.com/Documents/2210Z.pdf>

#### J.3.2.4.5 Tesla-Bellota Sub-area

Tesla-Bellota is a sub-area of the Stockton LCR area.

J.3.2.4.5.1 Tesla-Bellota LCR Sub-area Diagram

Figure J.3.2-19 Tesla-Bellota LCR Sub-area

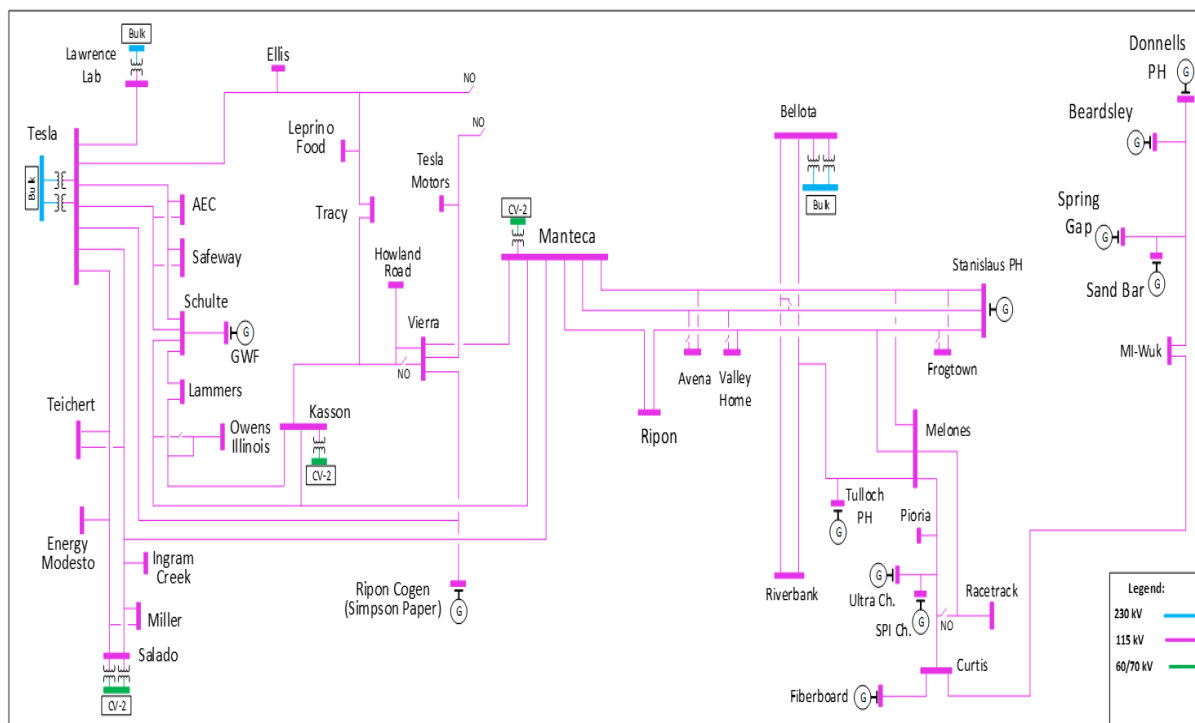

J.3.2.4.5.2 Tesla Bellota LCR Sub-area Load and Resources

Table J.3.2-18 provides the forecasted load and resources. The list of generators within the LCR sub-area are provided in Attachment A.

Table J.3.2-18 Tesla-Bellota LCR Sub-area 2032 Forecast Load and Resources

Load (MW)		Generation (MW)	Aug NQC	At Peak
Gross Load	1033	Market, Net Seller	475	475
AEE	-5	Battery	152	152
Behind the meter DG	0	MUNI, QF	112	112
<b>Net Load</b>	<b>1028</b>	LTPP Preferred Resources	16	0
Transmission Losses	22	Existing 20-minute Demand Response	0	0
Pumps	0	Mothballed	0	0
<b>Load + Losses + Pumps</b>	<b>1050</b>	<b>Total</b>	<b>455</b>	<b>439</b>

All of the resources needed to meet the Stanislaus sub-area count towards the Tesla-Bellota sub-area LCR need.

**J.3.2.4.5.3 Tesla-Bellota LCR Sub-area Hourly Profiles**

Figure J.3.2-20 illustrates the forecast 2020 profile for the peak day for the Tesla-Bellota sub-area with the Category P6 normal and emergency load serving capabilities without local capacity resources. The chart also includes an estimated amount of energy storage that can be added to this local area from charging restriction perspective and the amount of 4-hour storage that can be added to replace local capacity on a 1 MW for 1 MWh basis. Figure J.3.2-21 illustrates the forecast 2032 hourly profile for Tesla-Bellota sub-area with of the Category P6 emergency load serving capability without local capacity resources.

Figure J.3.2-20 Tesla-Bellota LCR Sub-area 2032 Peak Day Forecast Profiles

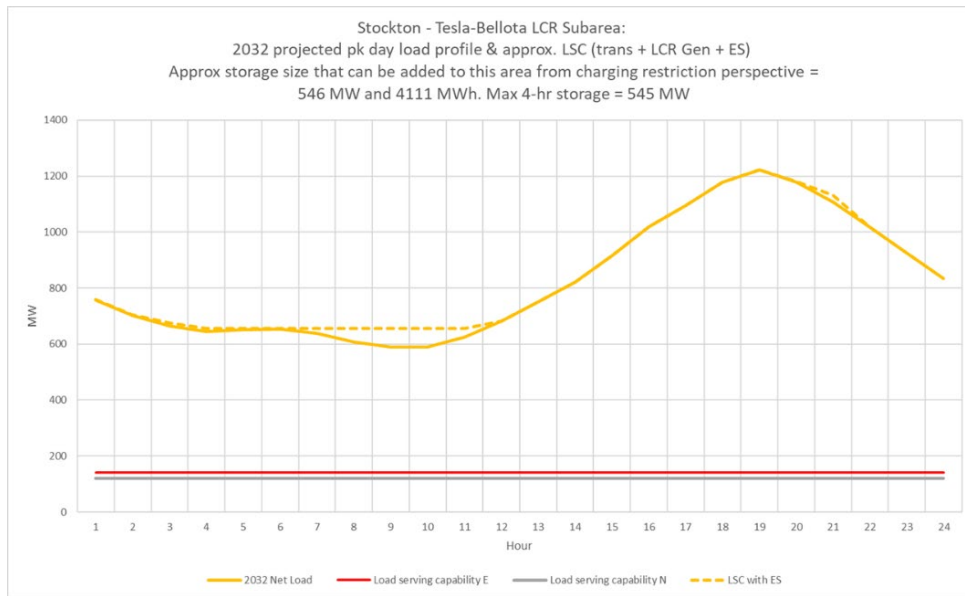
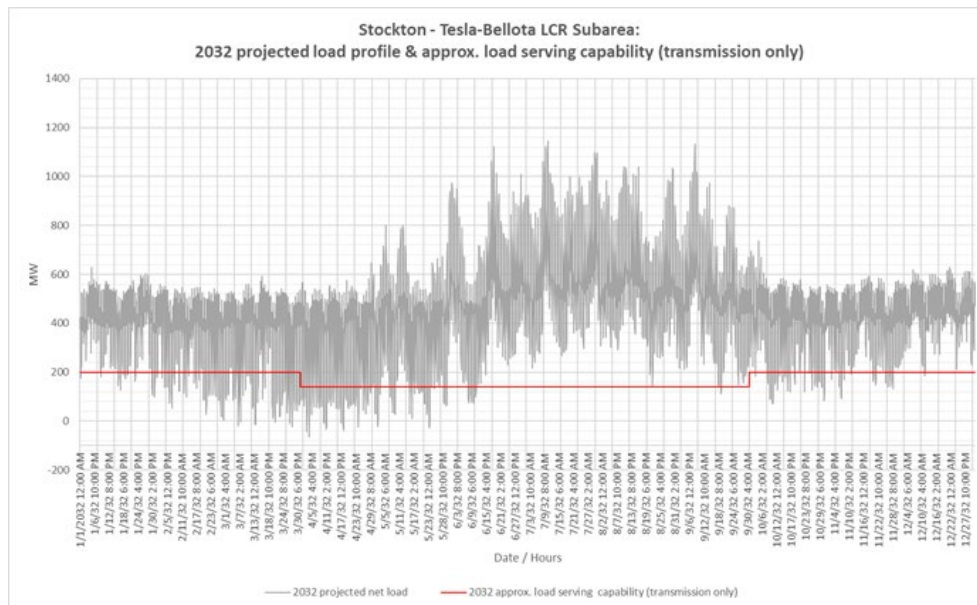

Figure J.3.2-21 Tesla-Bellota LCR Sub-area 2032 Forecast Hourly Profile



**J.3.2.4.5.4 Tesla-Bellota LCR Sub-area (Stockton Overall) Requirement**

Table J.3.2-19 identifies the sub-area LCR requirements. The LCR requirement for Category P2 and P6 contingency is 1268 MW including a 513 MW deficiency.

Table J.3.2-19 Tesla-Bellota LCR Sub-area Requirements

Year	Limit	Category	Limiting Facility	Contingency	LCR (MW) (Deficiency)
2032	First limit	P2-4	Melones–Riverbank-Bellota 115 kV	P2-4:A11:10:_Tesla 115 kV - Section 2D & 1D	785 (166)
2032	First limit	P6	Tesla – Tracy 115 kV	Schulte – Lammers 115 kV & Schulte-Kasson-Manteca 115 kV	960 (513)
Total LCR Need for Tesla – Bellota Sub-area in 2032					1268 (513)

**J.3.2.4.5.5 Effectiveness factors:**

All units within the Tesla-Bellota Sub-area have the same effectiveness factor.

For most helpful procurement information please read procedure 2210Z Effectiveness Factors under 7410 posted at: <http://www.aiso.com/Documents/2210Z.pdf>

**J.3.2.4.6 Stockton Overall****J.3.2.4.6.1 Stockton LCR Area Overall Requirement**

The requirement for this area is driven by the requirement for the Tesla-Bellota sub-area. Table J.3.2-20 identifies the area requirements. The LCR requirement for Category P6 contingency is 1268 MW with a 513 MW NQC deficiency.

Table J.3.2-20 Stockton LCR Sub-area Overall Requirements

Year	Limit	Category	Limiting Facility	Contingency	LCR (MW) (Deficiency)
2032		P6	Stockton Overall		1268 (513)

**J.3.2.4.6.2 Changes compared to the 2027 LCT study**

The load forecast went up by 99 MW and the total LCR need has increased by 315 MW mostly due to load growth and increased deficiency due to change in binding constraint and contingency.

### J.3.2.5 Greater Bay Area

#### J.3.2.5.1 Area Definition:

The transmission tie lines into the Greater Bay Area are:

Lakeville-Sobrante 230 kV  
Ignacio-Sobrante 230 kV  
Parkway-Moraga 230 kV  
Bahia-Moraga 230 kV  
Lambie SW Sta-Vaca Dixon 230 kV  
Peabody-Contra Costa P.P. 230 kV  
Tesla-Kelso 230 kV  
Tesla-Delta Switching Yard 230 kV  
Tesla-Pittsburg #1 230 kV  
Tesla-Pittsburg #2 230 kV  
Tesla-Newark #1 230 kV  
Tesla-Newark #2 230 kV  
Tesla-Ravenswood 230 kV  
Tesla-Metcalf 500 kV  
Moss Landing-Metcalf 500 kV  
Moss Landing-Metcalf #1 230 kV  
Moss Landing-Metcalf #2 230 kV  
Oakdale TID-Newark #1 115 kV  
Oakdale TID-Newark #2 115 kV

The substations that delineate the Greater Bay Area are:

Lakeville is out Sobrante is in  
Ignacio is out Sobrante is in  
Parkway is out Moraga is in  
Bahia is out Moraga is in  
Lambie SW Sta is in Vaca Dixon is out  
Peabody is out Contra Costa P.P. is in  
Tesla is out Kelso is in  
Tesla is out Delta Switching Yard is in

- Tesla is out Pittsburg is in
- Tesla is out Pittsburg is in
- Tesla is out Newark is in
- Tesla is out Newark is in
- Tesla is out Ravenswood is in
- Tesla is out Metcalf is in
- Moss Landing is out Metcalf is in
- Moss Landing is out Metcalf is in
- Moss Landing is out Metcalf is in
- Oakdale TID is out Newark is in
- Oakdale TID is out Newark is in

**J.3.2.5.1.1 Greater Bay LCR Area Diagram**

Figure J.3.2-22 Greater Bay LCR Area

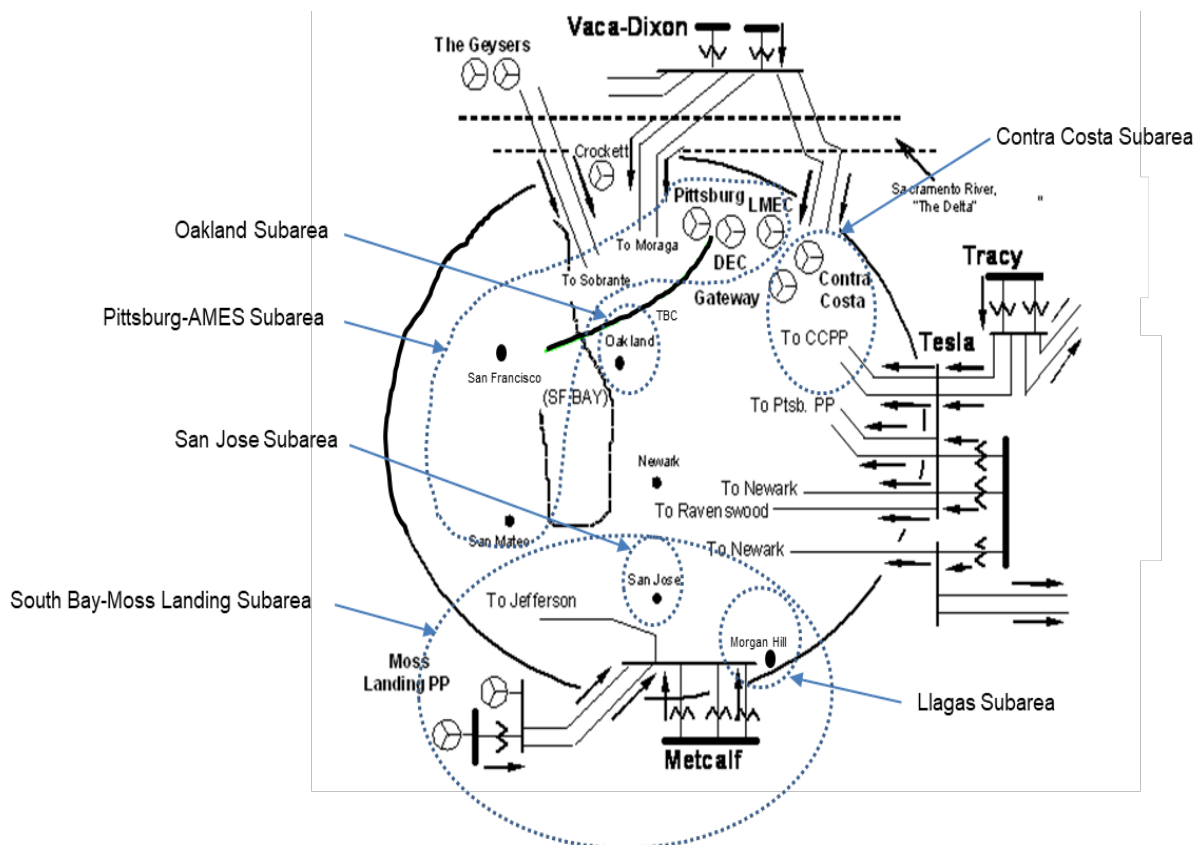

**J.3.2.5.1.2 Greater Bay LCR Area Load and Resources**

Table J.3.2-21 provides the forecasted load and resources. The list of generators within the LCR area are provided in Attachment A.

In year 2032 the estimated time of local area peak is 19:00 PM.

At the local area peak time the estimated, ISO metered, solar output is 0%.

If required, all technology type resources, including solar, are dispatched at NQC.

Table J.3.2-21 Greater Bay Area LCR Area 2032 Forecast Load and Resources

Load (MW)		Generation (MW)	Aug NQC	At Peak
Gross Load (inc. ATE)	12,975	Market, Net Seller, Wind	6199	6199
AAEE	-158	Battery	1112	1112
Behind the meter DG	0	MUNI, QF	611	611
<b>Net Load</b>	<b>12,817</b>	Solar	16	0
Transmission Losses	348	Existing 20-minute Demand Response	0	0
Pumps	264	Mothballed	0	0
<b>Load + Losses + Pumps</b>	<b>13,429</b>	<b>Total</b>	<b>7,938</b>	<b>7,922</b>

#### J.3.2.5.1.3 Approved transmission projects modeled

Oakland Clean Energy Initiative Project (Oakland CTs are assumed retired)

Morgan Hill Area Reinforcement (revised scope)

Metcalf-Piercy & Swift and Newark-Dixon Landing 115 kV Upgrade

East Shore-Oakland J 115 kV Reconductoring Project

Vaca Dixon-Lakeville 230 kV Corridor Series Compensation

Metcalf-Evergreen 115 kV Line Reconductoring

South of San Mateo Capacity Increase

San Jose Area HVDC Line (Newark - NRS)

San Jose Area HVDC Line (Metcalf – San Jose)

Series Compensation on Los Esteros-Nortech 115 kV Line

New Collinsville 500 kV substation

#### J.3.2.5.2 Llagas Sub-area

Llagas is a sub-area of the Greater Bay LCR area.

J.3.2.5.2.1 Llagas LCR Sub-area Diagram

Figure J.3.2-23 Llagas LCR Sub-area

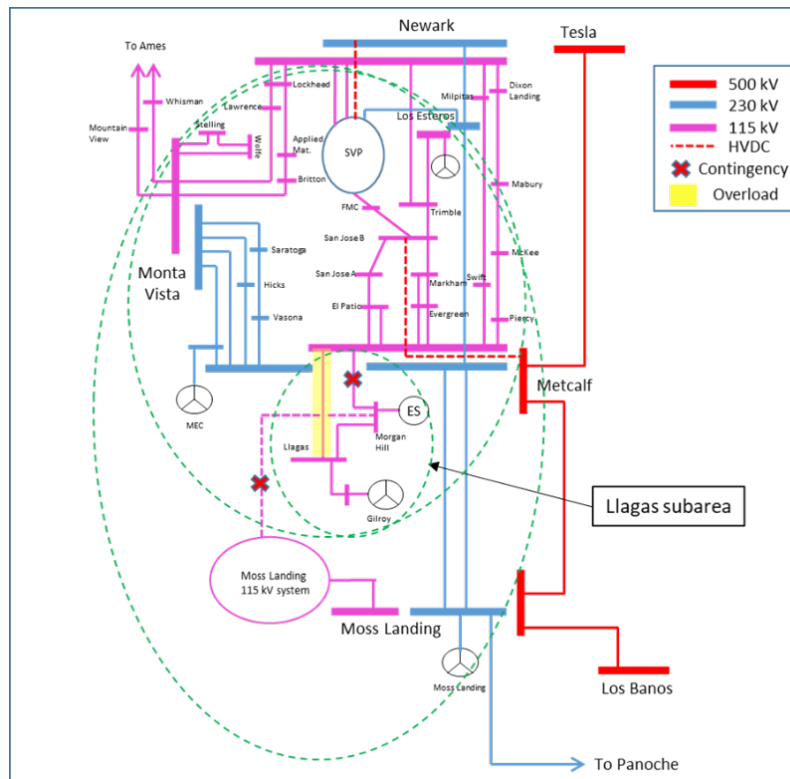

J.3.2.5.2.2 Llagas LCR Sub-area Load and Resources

Table J.3.2-22 provides the forecasted load and resources. The list of generators within the LCR sub-area are provided in Attachment A.

Table J.3.2-22 Llagas LCR Sub-area 2032 Forecast Load and Resources

Load (MW)		Generation (MW)	Aug NQC	At Peak
Gross Load (inc. ATE)	309	Market, Net Seller	256	256
AAEE	-4	Battery	20	20
Behind the meter DG	0	MUNI, QF	0	0
<b>Net Load</b>	<b>305</b>	Solar	0	0
Transmission Losses	2	Existing 20-minute Demand Response	0	0
Pumps	0	Mothballed	0	0
<b>Load + Losses + Pumps</b>	<b>307</b>	<b>Total</b>	<b>276</b>	<b>276</b>



**J.3.2.5.2.3 Llagas LCR Sub-area Hourly Profiles**

Figure J.3.2-24 illustrates the forecast 2032 profile for the peak day for the Llagas LCR sub-area with the Category P6 normal and emergency load serving capabilities without local capacity resources. The chart also includes an estimated amount of energy storage that can be added to this local area from charging restriction perspective and the amount of 4-hour storage that can be added to replace local capacity on a 1 MW for 1 MWh basis. Figure J.3.2-25 illustrates the forecast 2032 hourly profile for Llagas LCR sub-area with the Category P6 emergency load serving capability without local capacity resources.

Figure J.3.2-24 Llagas LCR Sub-area 2032 Peak Day Forecast Profiles

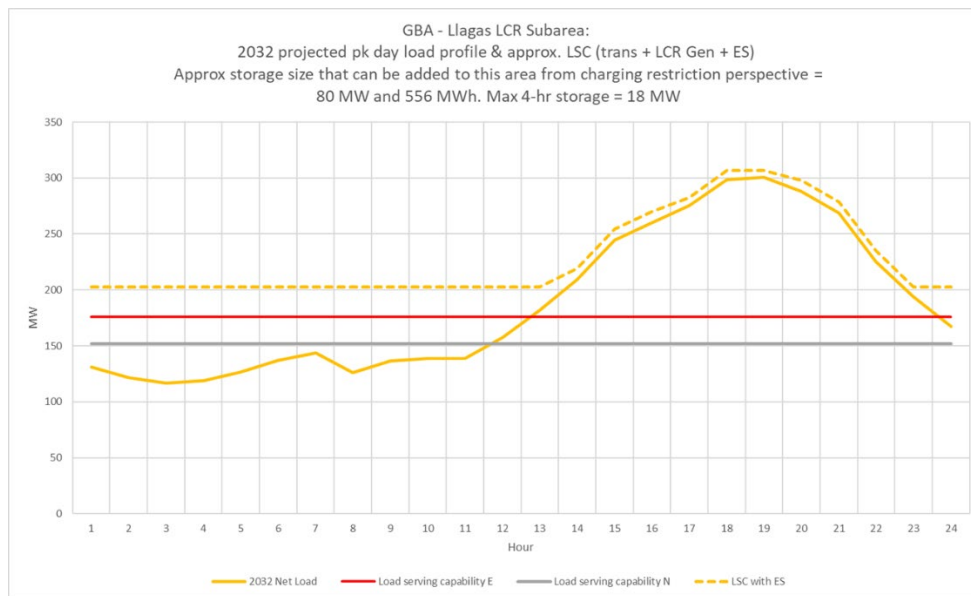
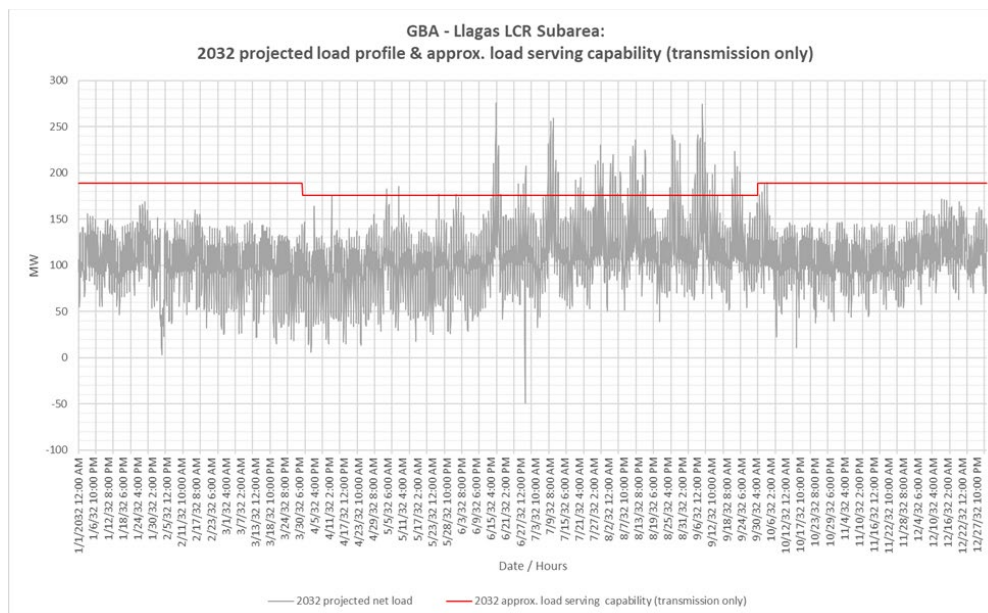

Figure J.3.2-25 Llagas LCR Sub-area 2032 Forecast Hourly Profiles



**J.3.2.5.2.4 Llagas LCR Sub-area Requirement**

Table J.3.2-23 identifies the sub-area LCR requirements. The LCR requirement for the Category P6 contingency is 145 MW.

Table J.3.2-23 Llagas LCR Sub-area Requirements

Year	Limit	Category	Limiting Facility	Contingency	LCR (MW)
2032	First limit	P6	Morgan Hill-Llagas 115 kV line	Metcalf-Morgan Hill 115 kV & Morgan Hill-Green Valley 115 kV	145

**J.3.2.5.2.5 Effectiveness factors:**

All units within the Llagas Sub-area have the same effectiveness factor.

**J.3.2.5.3 San Jose Sub-area**

San Jose is a sub-area of the Greater Bay LCR area.

**J.3.2.5.3.1 San Jose LCR Sub-area Diagram**

The San Jose LCR sub-area is identified in Figure 3.2-23.

**J.3.2.5.3.2 San Jose LCR Sub-area Load and Resources**

Table J.3.2-24 provides the forecast load and resources in San Jose LCR sub-area in 2032. The list of generators within the LCR sub-area are provided in Attachment A.

Table J.3.2-24 San Jose LCR Sub-area 2032 Forecast Load and Resources

Load (MW)		Generation (MW)	Aug NQC	At Peak
Gross Load (inc. ATE)	3636	Market, Net Seller	591	591
AAEE	-43	Battery	185	185
Behind the meter DG	0	MUNI, QF	198	198
<b>Net Load</b>	<b>3593</b>	Solar	1	0
Transmission Losses	78	Existing 20-minute Demand Response	0	0
Pumps	0	Mothballed	0	0
<b>Load + Losses + Pumps</b>	<b>3671</b>	<b>Total</b>	<b>975</b>	<b>974</b>

**J.3.2.5.3.3 San Jose LCR Sub-area Hourly Profiles**

Figure J.3.2-26 illustrates the forecast 2032 profile for the peak day for the San Jose LCR sub-area with the Category P2 normal and emergency load serving capabilities without local capacity

resources. The chart also includes an estimated amount of energy storage that can be added to this local area from charging restriction perspective and the amount of 4-hour storage that can be added to replace local capacity on a 1 MW for 1 MWh basis. Figure J.3.2-27 illustrates the forecast 2032 hourly profile for San Jose LCR sub-area with the Category P2 emergency load serving capability without local capacity resources.

Figure J.3.2-26 San Jose LCR Sub-area 2032 Peak Day Forecast Profiles

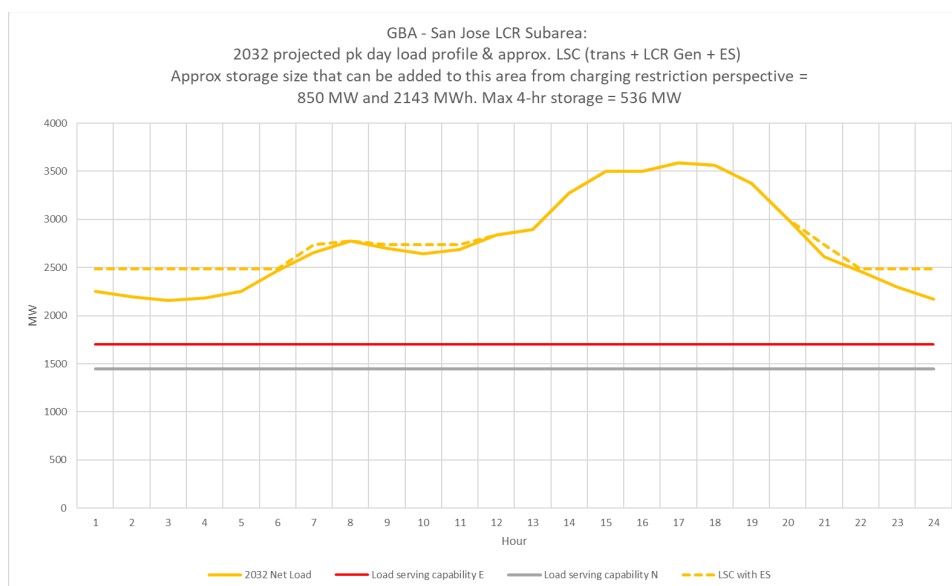
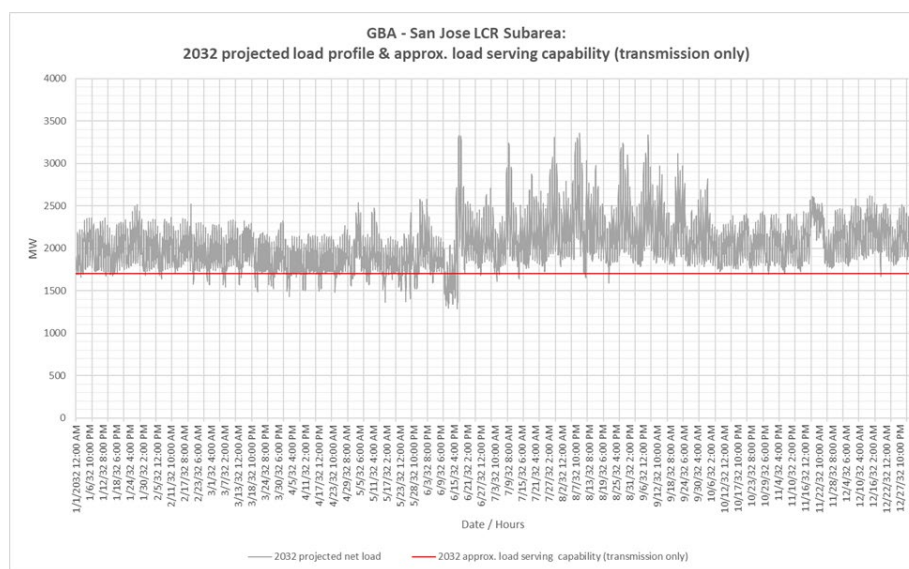

Figure J.3.2-27 San Jose LCR Sub-area 2032 Forecast Hourly Profiles



**J.3.2.5.3.4 San Jose Sub-area Requirement**

Table J.3.2-25 identifies the sub-area LCR requirements. The LCR requirement for the Category P2 contingency is 1,060 MW including 85 MW of deficiency. A second limit was also calculated

with a reliability project approved in the 2022-2023 TPP. The LCR requirement associated with the second limit is 545 MW.

Table J.3.2-25 San Jose LCR Sub-area Requirements

Year	Limit	Category	Limiting Facility	Contingency	LCR (MW) (Deficiency)
2032	First limit	P2	Metcalf 230/115 kV transformer # 1 or # 3	Metcalf 230kV - Section 2D & 2E	1,060 (85)
2032	Second limit	P6	Metcalf-El Patio 115 kV line	Newark-NRS and Metcalf-San Jose B HVDC lines	545

#### J.3.2.5.3.5 Effectiveness factors:

Effectiveness factors for generators in the San Jose LCR sub-area are in Attachment B table titled [San Jose](#). For other helpful procurement information please read procedure 2210Z Effectiveness Factors under 7320 posted at: <http://www.caiso.com/Documents/2210Z.pdf>

#### J.3.2.5.4 South Bay-Moss Landing Sub-area

South Bay-Moss Landing is a sub-area of the Greater Bay LCR area.

##### J.3.2.5.4.1 South Bay-Moss Landing LCR Sub-area Diagram

The South Bay-Moss Landing LCR sub-area is identified in Figure J.3.2-23.

##### J.3.2.5.4.2 South Bay-Moss Landing LCR Sub-area Load and Resources

Table 3.2-26 provides the forecast load and resources in South Bay-Moss Landing LCR sub-area in 2032. The list of generators within the LCR sub-area are provided in Attachment A.

Table J.3.2-26 South Bay-Moss Landing LCR Sub-area 2032 Forecast Load and Resources

Load (MW)		Generation (MW)	Aug NQC	At Peak
Gross Load (inc. ATE)	5526	Market, Net Seller	2209	2209
AAEE	-82	Battery	767	767
Behind the meter DG	0	MUNI, QF	197	197
<b>Net Load</b>	<b>5444</b>	Solar	6	0
Transmission Losses	124	Existing 20-minute Demand Response	0	0
Pumps	0	Mothballed	0	0
<b>Load + Losses + Pumps</b>	<b>5568</b>	<b>Total</b>	<b>3179</b>	<b>3173</b>

**J.3.2.5.4.3 South Bay-Moss Landing LCR Sub-area Hourly Profiles**

Figure J.3.2-28 illustrates the forecast 2032 profile for the peak day for the South Bay-Moss Landing LCR sub-area with the Category P6 normal and emergency load serving capabilities without local capacity resources. The chart also includes an estimated amount of energy storage that can be added to this local area from charging restriction perspective and the amount of 4-hour storage that can be added to replace local capacity on a 1 MW for 1 MW basis. The energy storage amount is incremental to the existing system and doesn't include approved energy storage. Figure J.3.2-29 illustrates the forecast 2032 hourly profile for South Bay-Moss Landing LCR sub-area with the Category P6 emergency load serving capability without local capacity resources.

Figure J.3.2-28 South Bay-Moss Landing LCR Sub-area 2032 Peak Day Forecast Profiles

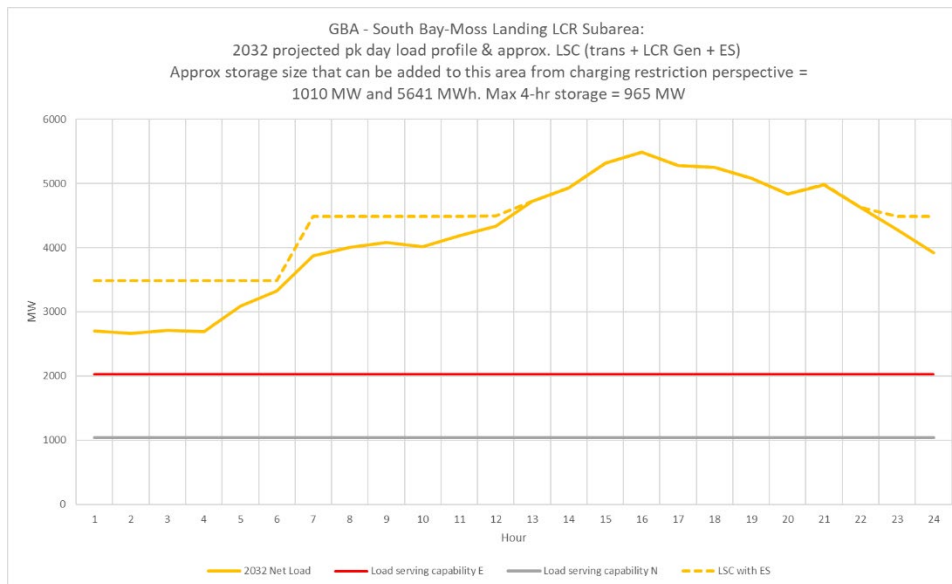
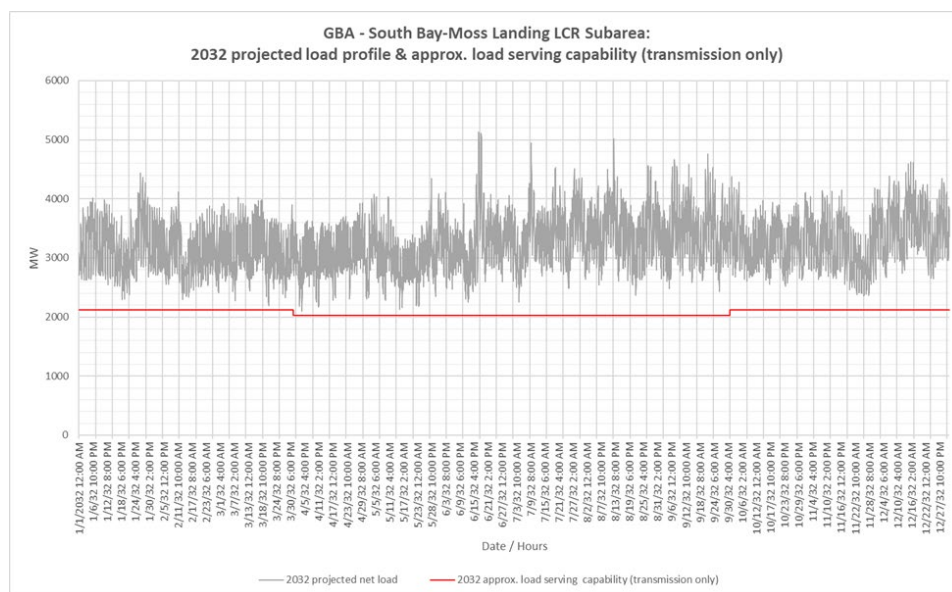

Figure J.3.2-29 South Bay-Moss Landing LCR Sub-area 2032 Forecast Hourly Profiles



**J.3.2.5.4.4 South Bay-Moss Landing LCR Sub- Requirement**

Table J.3.2-27 identifies the sub-area LCR requirements. The LCR requirement for the Category P6 contingency is 3,242 MW including 63 MW of deficiency.

Table J.3.2-27 South Bay-Moss Landing LCR Sub-area Requirements

Year	Limit	Category	Limiting Facility	Contingency	LCR (MW)
2032	First Limit	P6	Moss Landing-Las Aguilas 230 kV	Tesla-Metcalf 500 kV and Moss Landing-Los Banos 500 kV	3242 (63)

**J.3.2.5.4.5 Effectiveness factors:**

Effectiveness factors for generators in the South Bay-Moss Landing LCR sub-area are in Attachment B table titled [South Bay-Moss Landing](#).

For other helpful procurement information please read procedure 2210Z Effectiveness Factors under 7230 posted at: <http://www.aiso.com/Documents/2210Z.pdf>.

**J.3.2.5.5 Oakland Sub-area**

Oakland is a sub-area of the Greater Bay LCR area.

**J.3.2.5.5.1 Oakland LCR Sub-area Diagram**

Figure J.3.2-30 Oakland LCR Sub-area

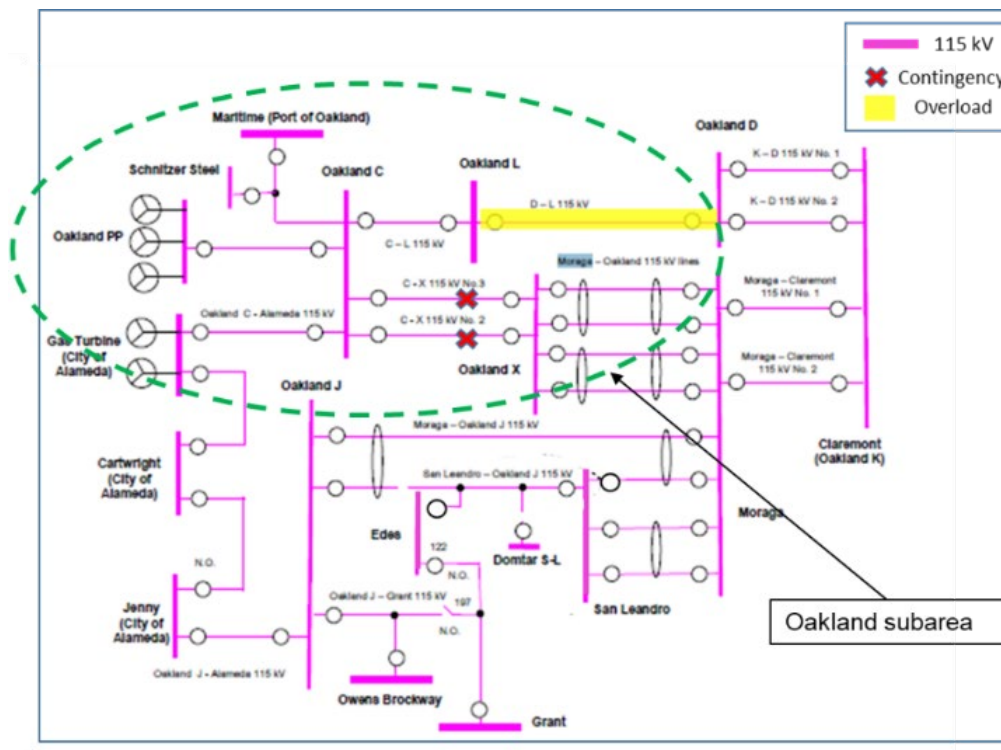

**J.3.2.5.5.2 Oakland LCR Sub-area Load and Resources**

Table J.3.2-28 provides the forecast load and resources in Oakland LCR sub-area in 2032. The list of generators within the LCR sub-area are provided in Attachment A.

Table J.3.2-28 Oakland LCR Sub-area 2032 Forecast Load and Resources

Load (MW)		Generation (MW)	Aug NQC	At Peak
Gross Load (inc. ATE)	193	Market, Net Seller	0	0
AAEE	-1	Battery	55	55
Behind the meter DG	0	MUNI, QF	49	49
<b>Net Load</b>	<b>192</b>	Solar	0	0
Transmission Losses	0	Existing 20-minute Demand Response	0	0
Pumps	0	Mothballed	0	0
<b>Load + Losses + Pumps</b>	<b>192</b>	<b>Total</b>	<b>104</b>	<b>104</b>

**J.3.2.5.5.3 Oakland LCR Sub-area Hourly Profiles**

Energy storage chart for the Oakland sub-area is not provided because the LCR in the sub-area is met by battery resource. As such, no non-battery resource is available for displacement for assessment of the additional energy storage estimation from the charging restriction perspective.

**J.3.2.5.5.4 Oakland LCR Sub-area Requirement**

Table J.3.2-29 identifies the sub-area requirements. The LCR requirement for the Category P6 contingency is 35 MW.

Table J.3.2-29 Oakland LCR Sub-area Requirements

Year	Limit	Category	Limiting Facility	Contingency	LCR (MW)
2032	First limit	P6	Oakland D-L 115 kV	Oakland C-X #2 & #3 115 kV cables	35 <sup>4</sup>

**J.3.2.5.5.5 Effectiveness factors:**

All units within the Oakland sub-area have the same effectiveness factor.

For most helpful procurement information please read procedure 2210Z Effectiveness Factors under 7320 posted at: <http://www.caiso.com/Documents/2210Z.pdf>

<sup>4</sup> This requirement doesn't reflect potential load transfer that could occur following the first contingency. An approved operating procedure including this load transfer could reduce this requirement.

**J.3.2.5.6 Ames-Pittsburg-Oakland Sub-areas Combined**

Ames-Pittsburg-Oakland is a sub-area of the Greater Bay LCR area.

**J.3.2.5.6.1 Ames-Pittsburg-Oakland LCR Sub-area Diagram**

Figure J.3.2-31 Ames-Pittsburg-Oakland LCR Sub-area

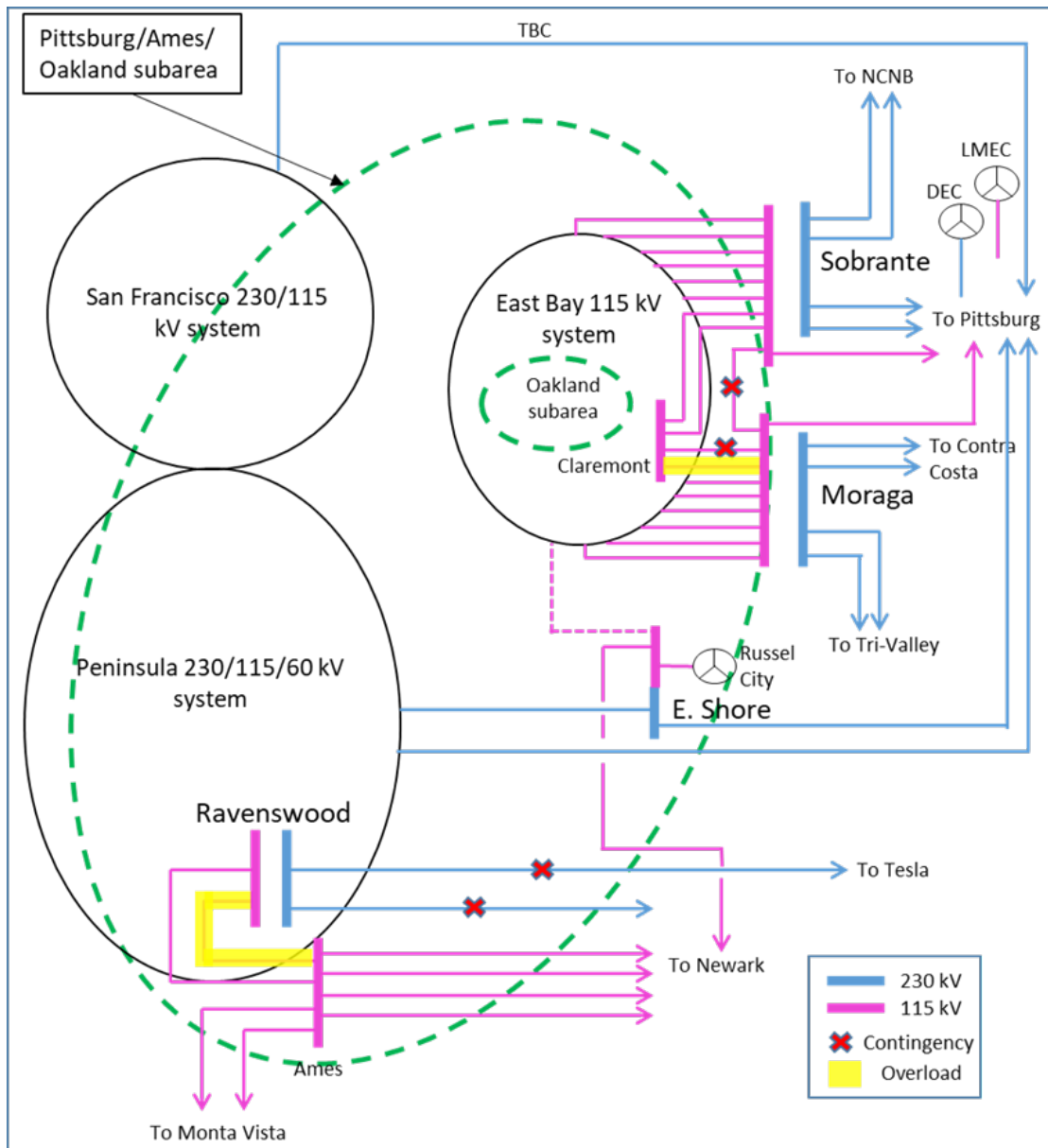

**J.3.2.5.6.2 Ames-Pittsburg-Oakland LCR Sub-area Load and Resources**

Table J.3.2-30 provides the forecast load and resources in Ames-Pittsburg-Oakland LCR sub-area in 2032. The list of generators within the LCR sub-area are provided in Attachment A.



Table J.3.2-30 Ames-Pittsburg-Oakland LCR Sub-area 2032 Forecast Load and Resources

Load (MW)	Generation (MW)	Aug NQC	At Peak
The Ames-Pittsburg-Oakland Sub-area does not has a defined load pocket with the limits based upon power flow through the area.	Market, Net Seller, Wind	2048	2048
	Battery	255	255
	MUNI, QF	280	280
	Solar	5	0
	Existing 20-minute Demand Response	0	0
	Mothball	0	0
	<b>Total</b>	<b>2587</b>	<b>2582</b>

### J.3.2.5.6.3 Ames-Pittsburg-Oakland LCR Sub-area Hourly Profiles

The Ames-Pittsburg-Oakland sub-area does not has a defined load pocket with the limits based upon power flow through the area. As such, no load profile is provided for this sub-area.

### J.3.2.5.6.4 Ames-Pittsburg-Oakland LCR Sub-area Requirement

Table J.3.2-31 identifies the sub-area LCR requirements. The LCR requirement for the Category P7 or P2 contingency is 2288 MW.

Table J.3.2-31 Ames-Pittsburg-Oakland LCR Sub-area Requirements

Year	Limit	Category	Limiting Facility	Contingency	LCR (MW)
2032	First limit	P7	Ames-Ravenswood #1 115 kV line	Newark-Ravenswood 230 kV & Tesla-Ravenswood 230 kV	2288
		P2	Sobrante 230/115 kV bank #2	Pittsburg Section 1D & 1E 230 kV	

A higher LCR for the Ames-Pittsburg-Oakland sub-area was identified for a contingency of Collinsville-Pittsburg #2 or #1 230 kV lines overloading the parallel line. The requirement for this constraint goes below the second requirement with the series reactors on the Collinsville-Pittsburg 230 kV lines as planned as part of the Collinsville project ultimate plan. This requirement can also be reduced with an operating solution of opening one of the 500/230 kV banks during the high load conditions.

### J.3.2.5.6.5 Effectiveness factors:

Effectiveness factors for generators in the Ames-Pittsburg-Oakland LCR sub-area are in Attachment B table titled [Ames/Pittsburg/Oakland](#).

For other helpful procurement information please read procedure 2210Z Effectiveness Factors under 7320 (T-165Z) posted at: <http://www.caiso.com/Documents/2210Z.pdf>

**J.3.2.5.7 Contra Costa Sub-area**

Contra Costa is a sub-area of the Greater Bay LCR area.

**J.3.2.5.7.1 Contra Costa LCR Sub-area Diagram**

Figure 3.2-32 Contra Costa LCR Sub-area

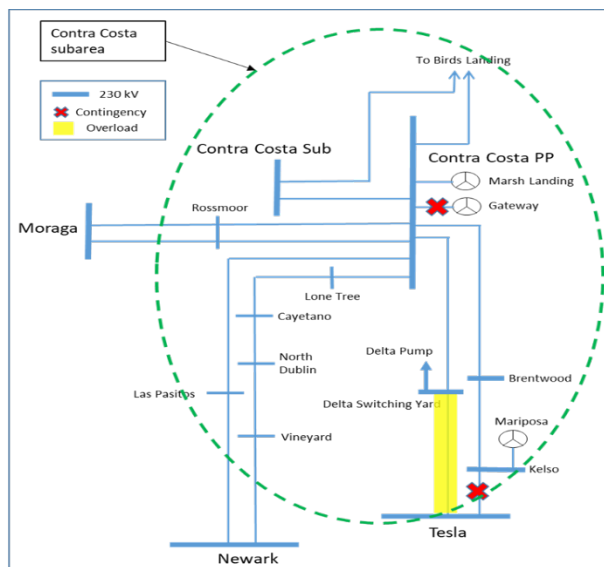

**J.3.2.5.7.2 Contra Costa LCR Sub-area Load and Resources**

Table J.3.2-32 provides the forecast load and resources in Contra Costa LCR sub-area in 2032. The list of generators within the LCR sub-area are provided in Attachment A.

Table J.3.2-32 Contra Costa LCR Sub-area 2032 Forecast Load and Resources

Load (MW)	Generation (MW)	Aug NQC	At Peak
The Contra Costa Sub-area does not have a defined load pocket with the limits based upon power flow through the area.	Market, Net Seller, Wind	1941	1941
	Battery	0	0
	MUNI, QF	127	127
	Solar	0	0
	Existing 20-minute Demand Response	0	0
	Mothballed	0	0
	<b>Total</b>		<b>2068</b>

**J.3.2.5.7.3 Contra Costa LCR Sub-area Hourly Profiles**

The Contra Costa sub-area does not has a defined load pocket with the limits based upon power flow through the area. As such, no load profile is provided for this sub-area.

**J.3.2.5.7.4 Contra Costa LCR Sub-area Requirement**

Table J.3.2-33 identifies the sub-area LCR requirements. The LCR requirement for the Category P3 contingency is 1,315 MW.

Table J.3.2-33 Contra Costa LCR Sub-area Requirements

Year	Limit	Category	Limiting Facility	Contingency	LCR (MW)
2032	First limit	P3	Delta Switching Yard-Tesla 230 kV	Kelso-Tesla 230 kV line and Gateway unit	1,315

**J.3.2.5.7.5 Effectiveness factors:**

For other helpful procurement information please read procedure 2210Z Effectiveness Factors under 7230 posted at: <http://www.caiso.com/Documents/2210Z.pdf>

**J.3.2.5.8 Bay Area overall**

**J.3.2.5.8.1 Bay Area LCR Area Hourly Profiles**

Figure J.3.2-33 illustrates the forecast 2032 profile for the peak day for the Bay Area LCR area with the Category P6 normal and emergency load serving capabilities without local capacity resources. The chart also includes an estimated amount of energy storage that can be added to this local area from charging restriction perspective and the amount of 4-hour storage that can be added to replace local capacity on a 1 MW for 1 MWh basis. Figure J.3.2-34 illustrates the forecast 2032 hourly profile for Bay Area LCR area with the Category P6 emergency load serving capability without local capacity resources.

Figure J.3.2-33 Bay Area LCR Area 2032 Peak Day Forecast Profiles

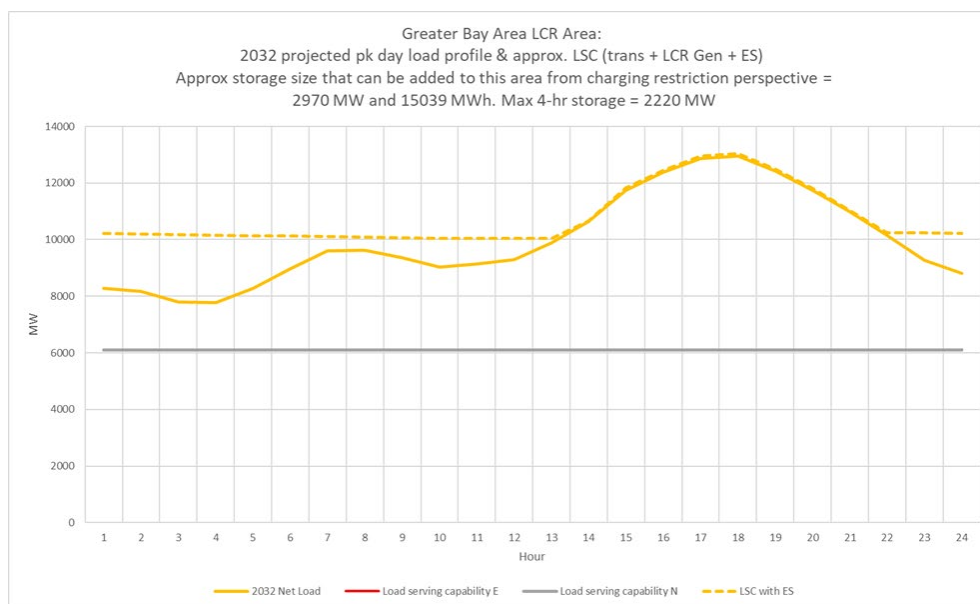
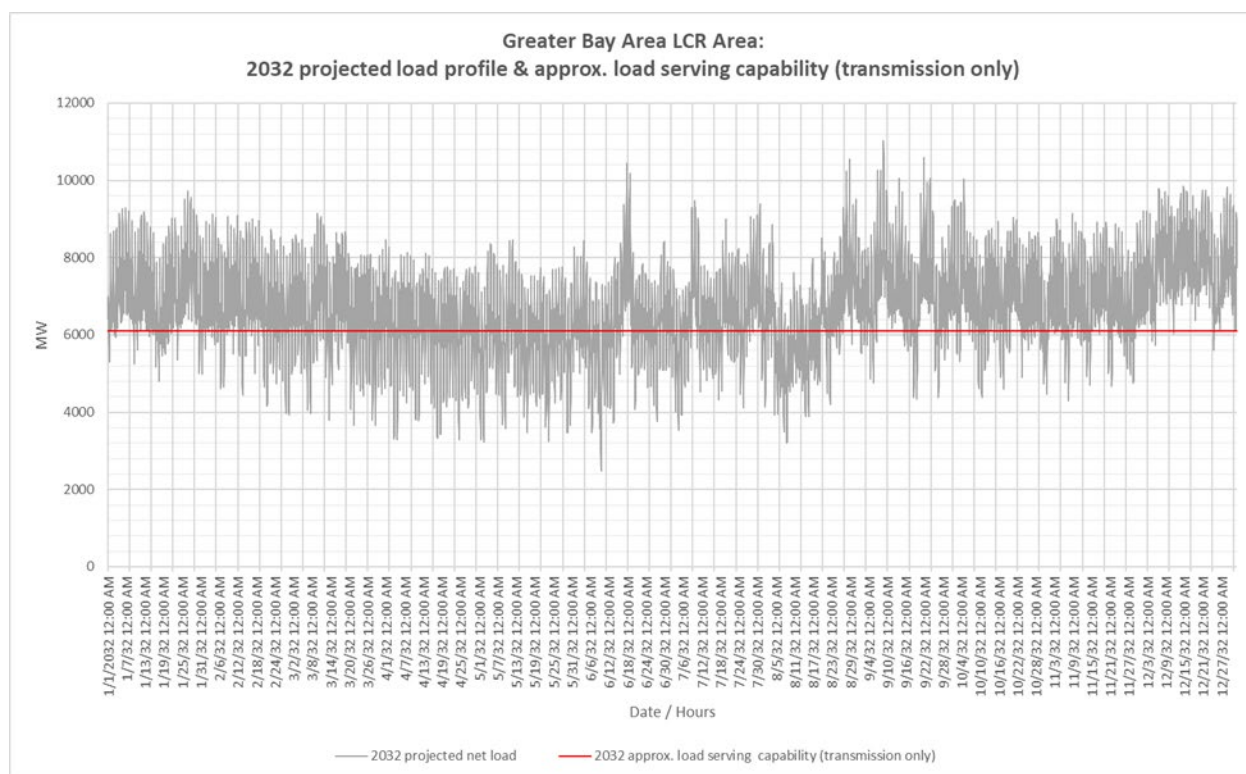

Figure J.3.2-34 Bay Area LCR Area 2032 Forecast Hourly Profiles



**J.3.2.5.8.2 Greater Bay LCR Area Overall Requirement**

Table J.3.2-34 identifies the area LCR requirements. The LCR requirement for the Category P6 contingency is 7,936 MW.

Table J.3.2-34 Bay Area LCR Overall area Requirements

Year	Limit	Category	Limiting Facility	Contingency	LCR (MW)
2032	First limit	P6	Metcalf 500/230 kV #13 transformer	Metcalf 500/230 kV #11 & #12 transformers	7,936

**J.3.2.5.8.3 Changes compared to the 2027 LCT study**

Load forecast went up by 1,696 MW and total LCR need went up by 396 MW mainly due to the load increase.

**J.3.2.6 Greater Fresno Area****J.3.2.6.1 Area Definition:**

The transmission facilities coming into the Greater Fresno area are:

Gates-Mustang #1 230 kV

Gates-Mustang #2 230 kV

Gates #5 230/70 kV Transformer Bank

Mercy Spring 230 /70 Bank # 1

Los Banos #3 230/70 Transformer Bank

Los Banos #4 230/70 Transformer Bank

Warnerville-Wilson 230kV

Melones-North Merced 230 kV line

Panoche-Tranquility #1 230 kV

Panoche-Tranquility #2 230 kV

Panoche #1 230/115 kV Transformer Bank

Panoche #2 230/115 kV Transformer Bank

Corcoran-Smyrna 115kV

Coalinga #1-San Miguel 70 kV The substations that delineate the Greater Fresno area are:

Gates is out Mustang is in

Gates is out Mustang is in

Gates 230 is out Gates 70 is in

Mercy Springs 230 is out Mercy Springs 70 is in

Los Banos 230 is out Los Banos 70 is in

Los Banos 230 is out Los Banos 70 is in

Warnerville is out Wilson is in

Melones is out North Merced is in

Panoche is out Tranquility #1 is in

Panoche is out Tranquility #2 is in

Panoche 230 is out Panoche 115 is in

Panoche 230 is out Panoche 115 is in

Corcoran is in Smyrna is out

Coalinga is in San Miguel is out

J.3.2.6.1.1 Fresno LCR Area Diagram

Figure J.3.2-35 Fresno LCR Area

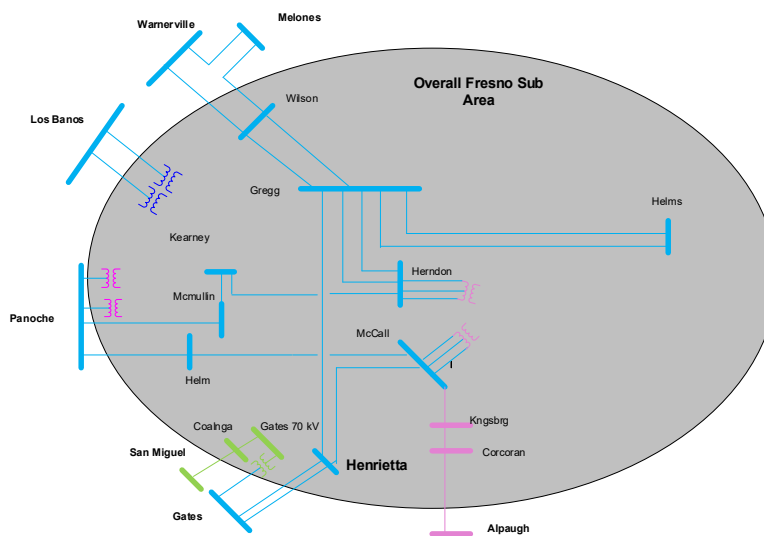

J.3.2.6.1.2 Fresno LCR Area Load and Resources

Table J.3.2-35 provides the forecast load and resources in Fresno LCR Area in 2032. The list of generators within the LCR sub-area are provided in Attachment A.

In year 2032 the estimated time of local area peak is 18:40 PM.

At the local area peak time the estimated, ISO metered, solar output is 12.00%.

If required, all non-solar technology type resources are dispatched at NQC.

Table J.3.2-35 Fresno LCR Area 2032 Forecast Load and Resources

Load (MW)		Generation (MW)	Aug NQC	At Peak
Gross Load	3805	Market, Net Seller	2376	2376
AAEE	-35	Battery, Hybrid	1061	1061
Behind the meter DG	0	MUNI, QF	216	216
<b>Net Load</b>	<b>3770</b>	Solar	467	208
Transmission Losses	143	Existing 20-minute Demand Response	0	0
Pumps	0	Mothballed	0	0
<b>Load + Losses + Pumps</b>	<b>3913</b>	<b>Total</b>	<b>4120</b>	<b>3861</b>

### J.3.2.6.1.3 Approved transmission projects modeled

- Panoche-Oro Loma 115 kV Reconductoring (Q4-2022)
- Wilson 115 kV Area Reinforcement (Q1-2028)
- Oro Loma 70 kV Area Reinforcement (Q4-2026)
- Giffen Line Reconductoring (Q1-2024)
- Borden 230/70 kV Transformer Bank #1 Capacity Increase (Q4-2027)
- Wilson-Oro Loma 115 kV Line Reconductoring (Q2-2028)
- Bellota-Warnerville 230kV Reconductoring (Q2-2024)
- Herndon - Bullard Nos. 1 and 2 115 kV Reconductoring (Q4-2026)
- Reedley 70 kV Reinforcement (Renamed to Reedley 70 kV Area Reinforcement Projects Include Battery at Dinuba) (Q4-2025)
- Coppermine 70 kV Reinforcement Project (Q4-2027)

### J.3.2.6.2 Hanford Sub-area

Hanford is a sub-area of the Fresno LCR area.

#### J.3.2.6.2.1 Hanford LCR Sub-area Diagram

Figure J.3.2-36 Hanford LCR Sub-area

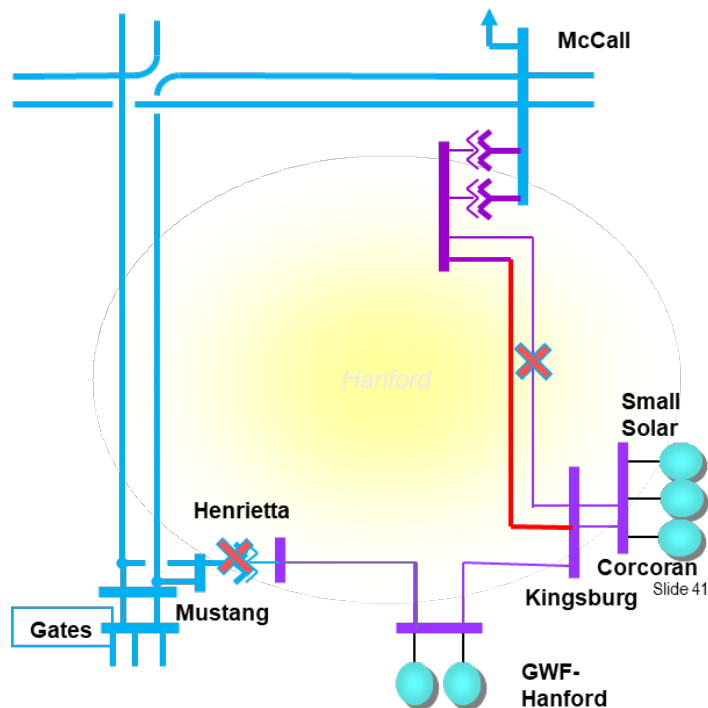

**J.3.2.6.2.2 Hanford LCR Sub-area Load and Resources**

Table J.3.2-36 provides the forecast load and resources in Hanford LCR sub-area in 2032. The list of generators within the LCR sub-area are provided in Attachment A.

Table J.3.2-36 Hanford LCR Sub-area 2032 Forecast Load and Resources

Load (MW)		Generation (MW)	Aug NQC	At Peak
Gross Load	233	Market, Net Seller	123	123
AAEE	-3	Battery, Hybrid	0	0
Behind the meter DG	0	MUNI, QF	0	0
<b>Net Load</b>	<b>230</b>	Solar	<b>61</b>	<b>27</b>
Transmission Losses	6	Existing 20-minute Demand Response	0	0
Pumps	0	Mothballed	0	0
<b>Load + Losses + Pumps</b>	<b>236</b>	<b>Total</b>	<b>185</b>	<b>150</b>

**J.3.2.6.2.3 Hanford LCR Sub-area Hourly Profiles**

Figure J.3.2-37 illustrates the forecast 2032 profile for the peak day for the Hanford LCR sub-area with the Category P6 normal and emergency load serving capabilities without local capacity resources. The chart also includes an estimated amount of energy storage that can be added to this local area from charging restriction perspective and the amount of 4-hour storage that can be added to replace local capacity on a 1 MW for 1 MWh basis. Figure J.3.2-38 illustrates the forecast 2032 hourly profile for Hanford LCR sub-area with the Category P6 emergency load serving capability without local capacity resources.

Figure J.3.2-37 Hanford LCR Sub-area 2032 Peak Day Forecast Profiles

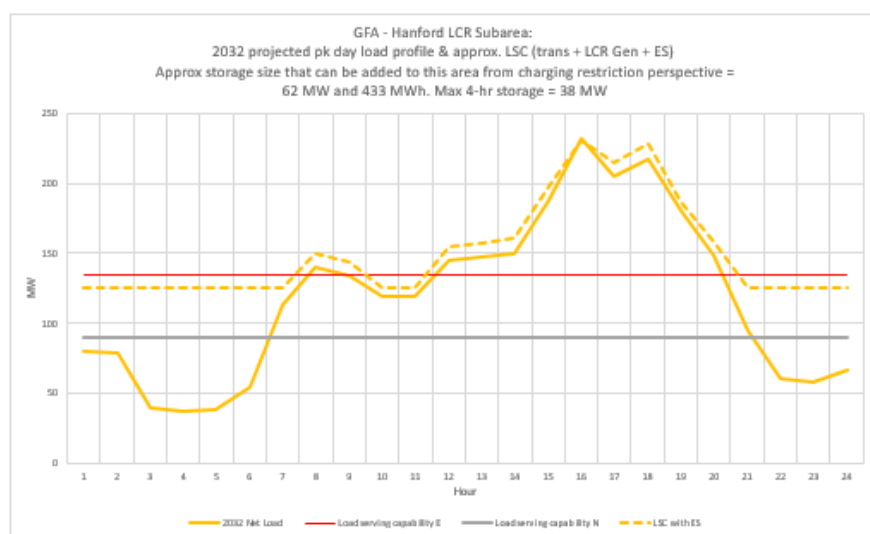
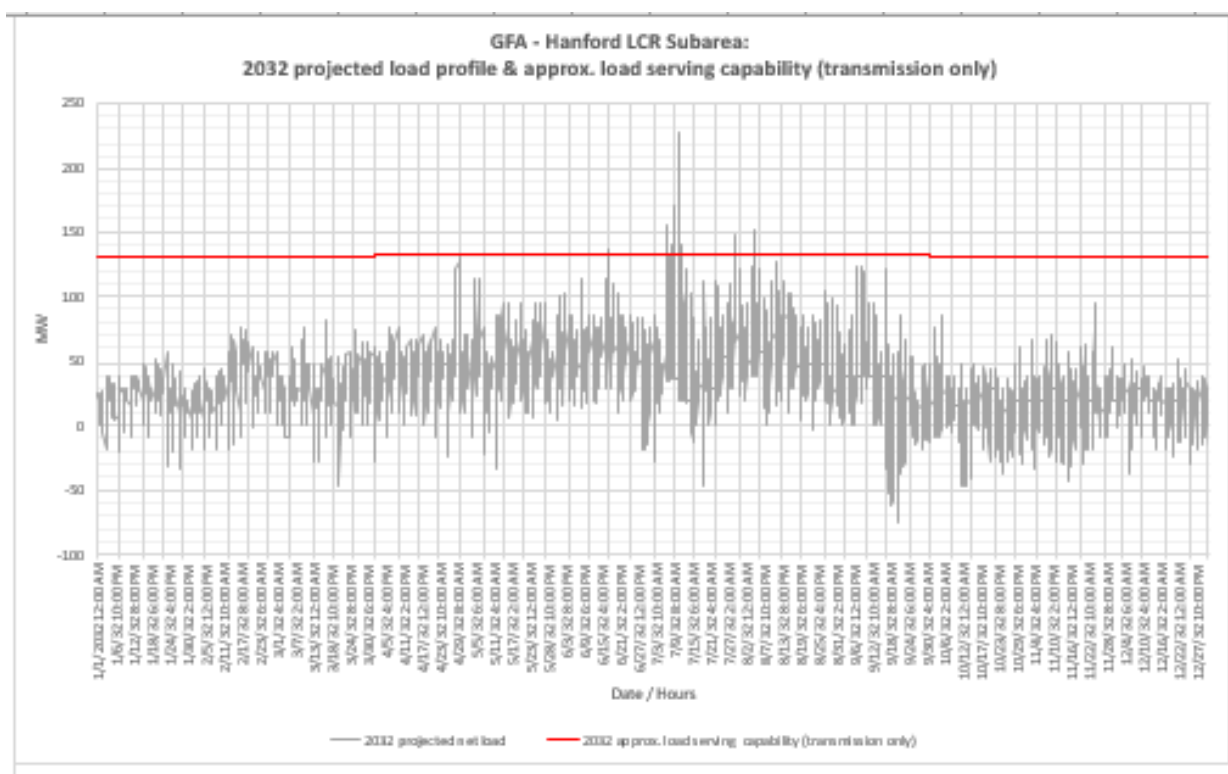



Figure J.3.2-38 Hanford LCR Sub-area 2032 Forecast Hourly Profiles



**J.3.2.6.2.4 Hanford LCR Sub-area Requirement**

Table J.3.2-37 identifies the sub-area requirements. The LCR Requirement for a Category P6 contingency is 98 MW.

Table J.3.2-37 Hanford LCR Sub-area Requirements

Year	Limit	Category	Limiting Facility	Contingency	LCR (MW) (Deficiency)
2032	First Limit	P6	McCall-Kingsburg #2 115 kV	McCall-Kingsburg #1 115kV line and Henrietta 230/115kV TB#3	98

**J.3.2.6.2.5 Effectiveness factors:**

All units within the Hanford sub-area have the same effectiveness factor.

For most helpful procurement information please read procedure 2210Z Effectiveness Factors under 7430 posted at: <http://www.caiso.com/Documents/2210Z.pdf>

**J.3.2.6.3 Coalinga Sub-area**

Coalinga is a sub-area of the Fresno LCR area.

**J.3.2.6.3.1 Coalinga LCR Sub-area Diagram**

Figure J.3.2-39 Coalinga LCR Sub-area

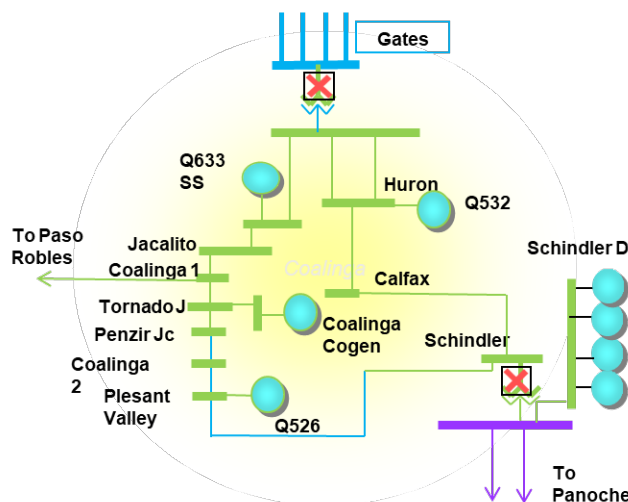

**J.3.2.6.3.2 Coalinga LCR Sub-area Load and Resources**

Table J.3.2-38 provides the forecast load and resources in Coalinga LCR sub-area in 2032. The list of generators within the LCR sub-area are provided in Attachment A.

Table J.3.2-38 Coalinga LCR Sub-area 2032 Forecast Load and Resources

Load (MW)		Generation (MW)	Aug NQC	At Peak
Gross Load	162	Market, Net Seller	0	0
AAEE	-2	Battery, Hybrid	175	175
Behind the meter DG	0	MUNI, QF	3	3
<b>Net Load</b>	<b>160</b>	Solar	25	11
Transmission Losses	5	Existing 20-minute Demand Response	0	0
Pumps	0	Mothballed	0	0
<b>Load + Losses + Pumps</b>	<b>165</b>	<b>Total</b>	<b>203</b>	<b>189</b>

**J.3.2.6.3.3 Coalinga LCR Sub-area Hourly Profiles**

Figure J.3.2-40 illustrates the forecast 2032 profile for the peak day for the Coalinga LCR sub-area with the Category P6 normal and emergency load serving capabilities without local capacity resources. The chart also includes an estimated amount of energy storage that can be added to this local area from charging restriction perspective and the amount of 4-hour storage that can be added to replace local capacity on a 1 MW for 1 MW basis. Figure J.3.2-41 illustrates the forecast 2032 hourly profile for Coalinga LCR sub-area with the Category P6 emergency load serving capability without local capacity resources.

Figure J.3.2-40 Coalinga LCR Sub-area 2032 Peak Day Forecast Profiles

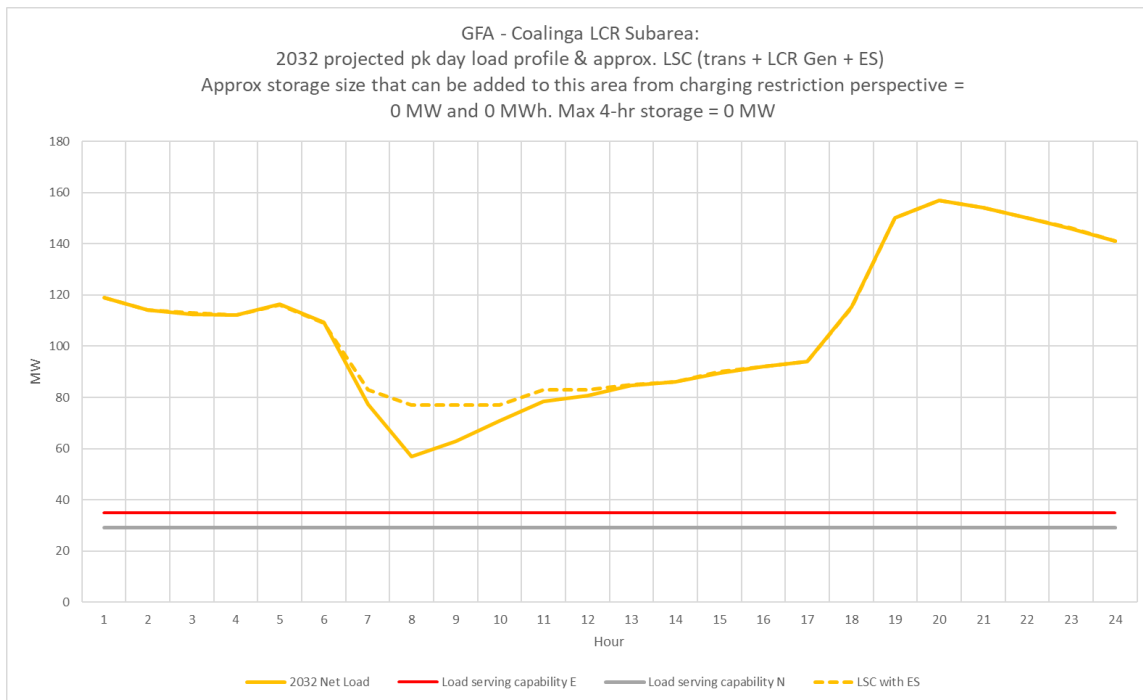
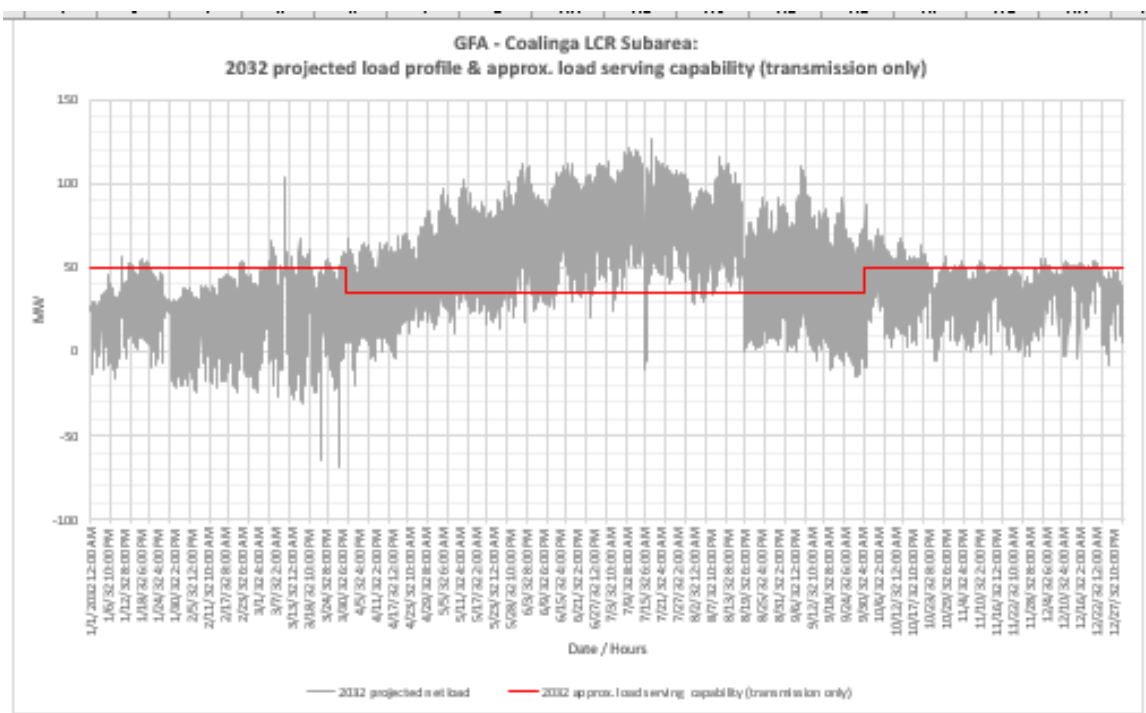

Figure J.3.2-41 Coalinga LCR Sub-area 2032 Forecast Hourly Profiles



**J.3.2.6.3.4 Coalinga LCR Sub-area Requirement**

Table J.3.2-39 identifies the sub-area requirements. The LCR Requirement for a Category P6 contingency is 127 MW.

Table J.3.2-39 Coalinga LCR Sub-area Requirements

Year	Limit	Category	Limiting Facility	Contingency	LCR (MW) (Deficiency)
2032	First Limit	P6	Overload on San-Miguel-Coalinga 70kV Line	T-1/T-1: Gates 230/70kV TB #5 and Schindler 115/70 kV TB#1	127

**J.3.2.6.3.5 Effectiveness factors:**

All units within the Coalinga Sub-area have the same effectiveness factor.

For most helpful procurement information please read procedure 2210Z Effectiveness Factors under 7430 posted at: <http://www.caiso.com/Documents/2210Z.pdf>

**J.3.2.6.4 Borden Sub-area**

Borden is a sub-area of the Fresno LCR area.

Borden Sub-area will be eliminated due to the Borden transformer capacity increase transmission project.

**J.3.2.6.5 Reedley Sub-area**

Reedley is a sub-area of the Fresno LCR area.

**J.3.2.6.5.1 Reedley LCR Sub-area Diagram**

Figure J.3.2-42 Reedley LCR Sub-area

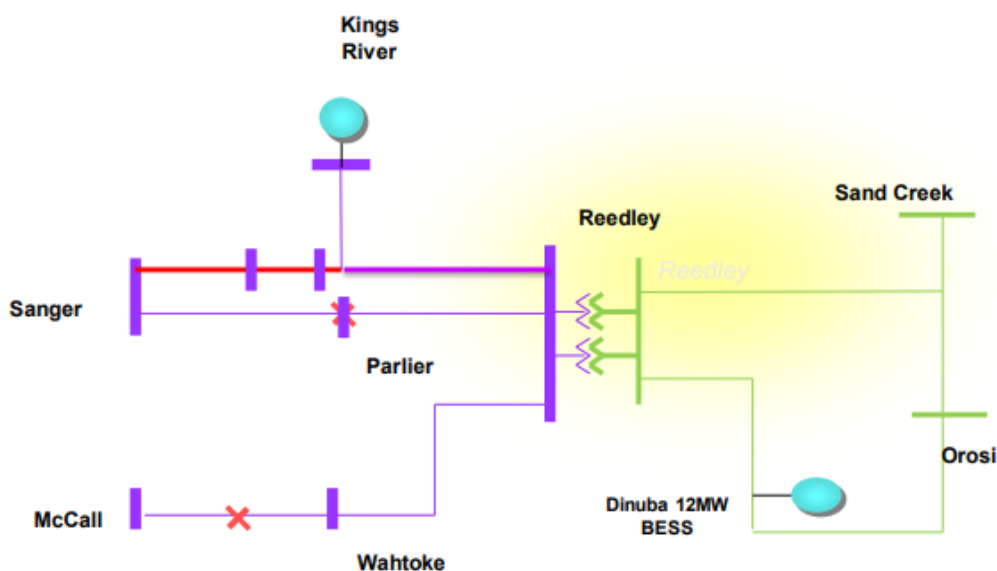

**J.3.2.6.5.2 Reedley LCR Sub-area Load and Resources**

Table J.3.2-40 provides the forecast load and resources in Reedley LCR sub-area in 2032. The list of generators within the LCR sub-area are provided in Attachment A.

Table J.3.2-40 Reedley LCR Sub-area 2032 Forecast Load and Resources

Load (MW)		Generation (MW)	Aug NQC	At Peak
Gross Load	248	Market, Net Seller	38	38
AAEE	-2	Battery, Hybrid	0	0
Behind the meter DG	0	MUNI, QF	0	0
<b>Net Load</b>	<b>246</b>	<b>LTPP Preferred Resources</b>	<b>0</b>	<b>0</b>
Transmission Losses	48	Existing 20-minute Demand Response	0	0
Pumps	0	Mothballed	0	0
<b>Load + Losses + Pumps</b>	<b>294</b>	<b>Total</b>	<b>38</b>	<b>38</b>

**J.3.2.6.5.3 Reedley LCR Sub-area Hourly Profiles**

Figure J.3.2-43 illustrates the forecast 2032 profile for the peak day for the Reedley LCR sub-area with the Category P6 normal and emergency load serving capabilities without local capacity resources. The chart also includes an estimated amount of energy storage that can be added to this local area from charging restriction perspective and the amount of 4-hour storage that can be added to replace local capacity on a 1 MW for 1 MWh basis. Figure J.3.2-44 illustrates the forecast 2032 hourly profile for Reedley LCR sub-area with the Category P6 emergency load serving capability without local capacity resources.

Figure J.3.2-43 Reedley LCR Sub-area 2032 Peak Day Forecast Profiles

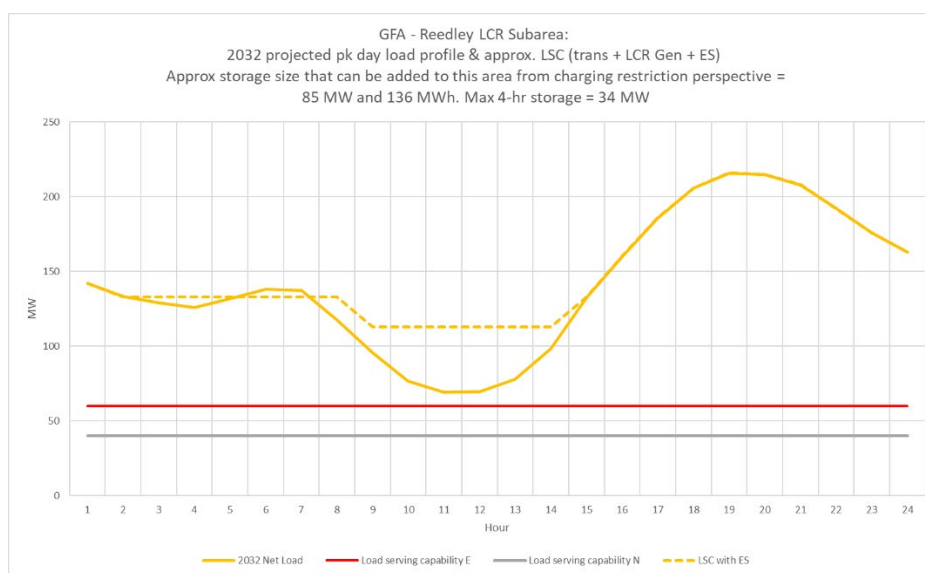
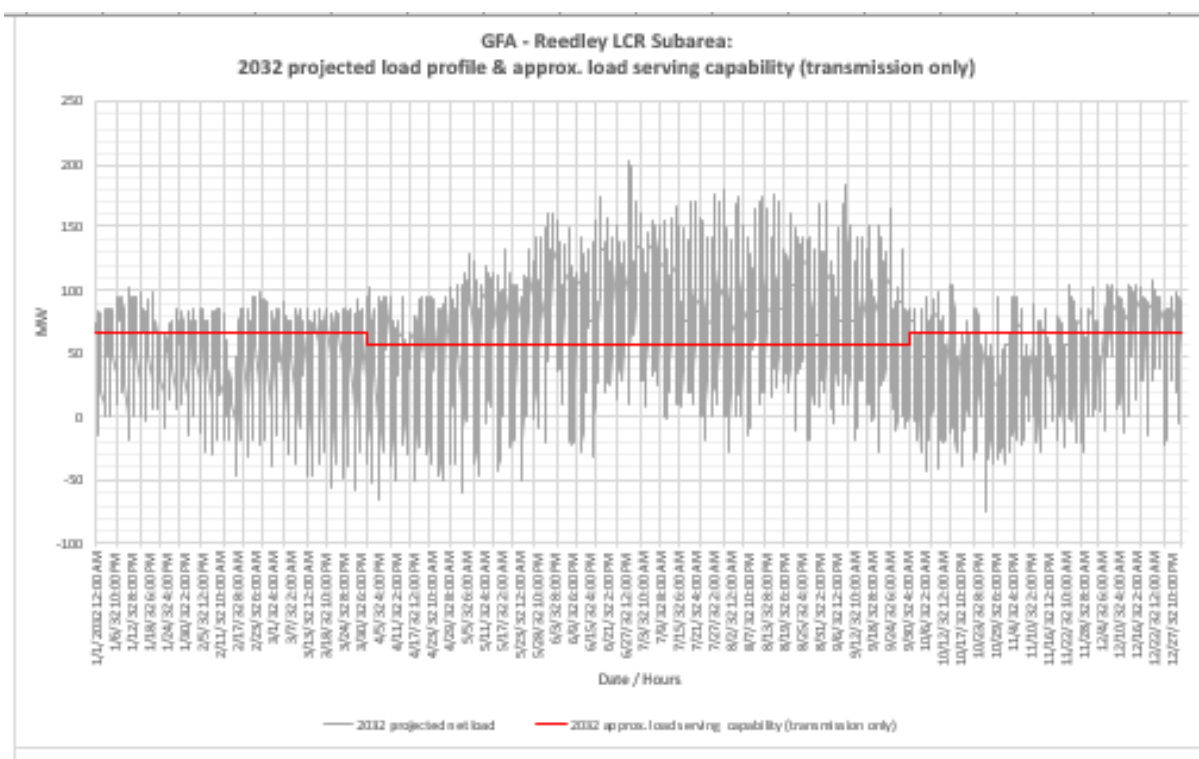

Figure J.3.2-44 Reedley LCR Sub-area 2032 Forecast Hourly Profiles



**J.3.2.6.5.4 Reedley LCR Sub-area Requirement**

Table J.3.2-41 identifies the sub-area requirements. The LCR Requirement for a Category P6 contingency is 166 MW including a 128 MW of deficiency.

Table J.3.2-41 Reedley LCR Sub-area Requirements

Year	Limit	Category	Limiting Facility	Contingency	LCR (MW) (Deficiency)
2032	First Limit	P6	Kings River-Sanger-Reedley 115 kV line with Wahtoke load online	McCall-Reedley 115 kV & Sanger-Reedley 115 kV	166 (128)

**J.3.2.6.5.5 Effectiveness factors:**

All units within the Reedley Sub-area have the same effectiveness factor.

For most helpful procurement information please read procedure 2210Z Effectiveness Factors under 7430 posted at: <http://www.aiso.com/Documents/2210Z.pdf>

**J.3.2.6.1 Panoche Sub-area**

Panoche is a sub-area of the Fresno LCR area.

**J.3.2.6.1.1 Panoche LCR Sub-area Diagram**

Figure J.3.2-45 Panoche LCR Sub-area

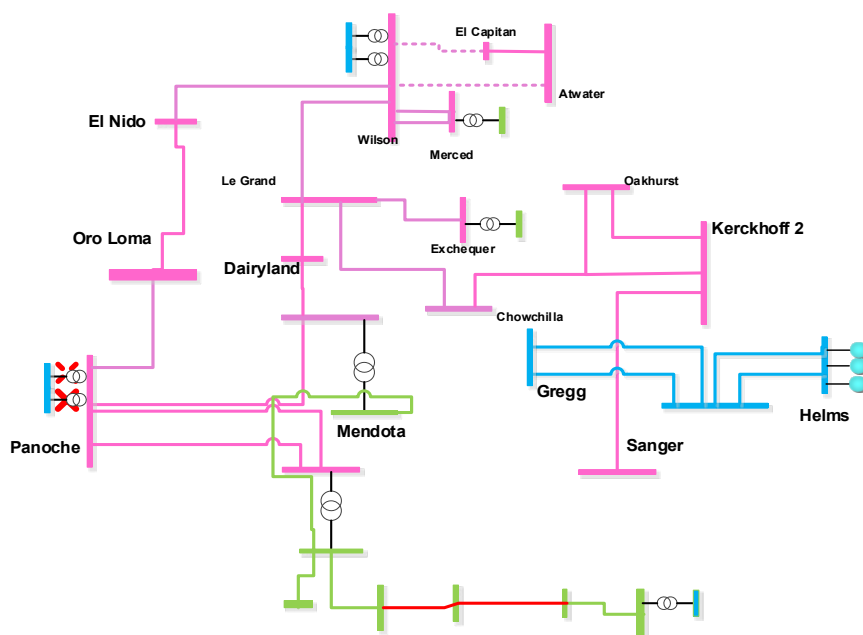

**J.3.2.6.1.2 Panoche LCR Sub-area Load and Resources**

Table J.3.2-42 provides the forecast load and resources in Panoche LCR sub-area in 2032. The list of generators within the LCR sub-area are provided in Attachment A.

Table J.3.2-42 Panoche LCR Sub-area 2032 Forecast Load and Resources

Load (MW)		Generation (MW)	Aug NQC	At Peak
Gross Load	569	Market, Net Seller	282	282
AAEE	-7	Battery, Hybrid	0	0
Behind the meter DG	0	MUNI, QF	103	103
<b>Net Load</b>	<b>562</b>	Solar	<b>95</b>	<b>42</b>
Transmission Losses	20	Existing 20-minute Demand Response	0	0
Pumps	0	Mothballed	0	0
<b>Load + Losses + Pumps</b>	<b>582</b>	<b>Total</b>	<b>480</b>	<b>427</b>

**J.3.2.6.1.3 Panoche LCR Sub-area Hourly Profiles**

Figure J.3.2-46 illustrates the forecast 2032 profile for the peak day for the Panoche LCR sub-area with the Category P6 normal and emergency load serving capabilities without local capacity

resources. The chart also includes an estimated amount of energy storage that can be added to this local area from charging restriction perspective and the amount of 4-hour storage that can be added to replace local capacity on a 1 MW for 1 MWh basis. Figure J.3.2-47 illustrates the forecast 2032 hourly profile for Panoche LCR sub-area with the Category P6 emergency load serving capability without local capacity resources.

Figure J.3.2-46 Panoche LCR Sub-area 2032 Peak Day Forecast Profiles

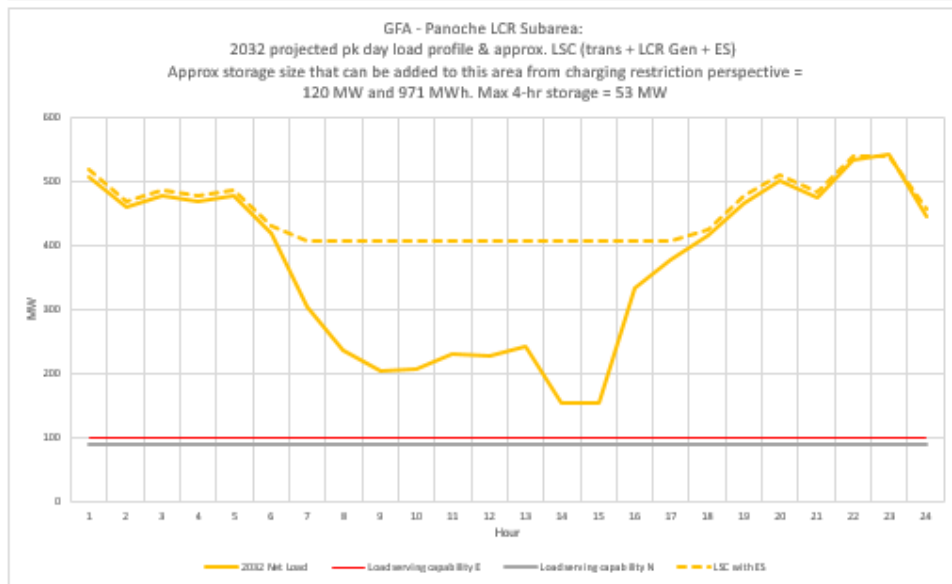
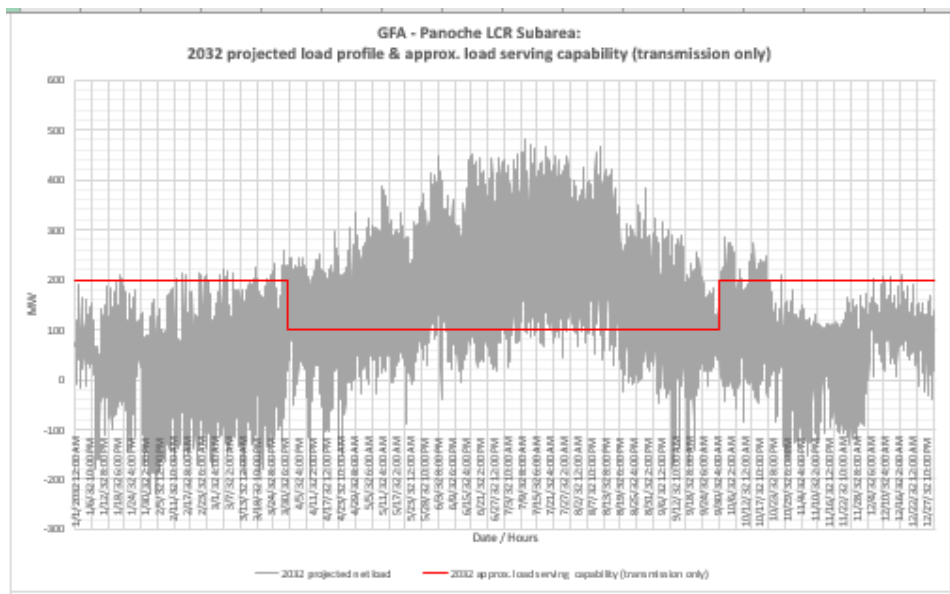

Figure J.3.2-47 Panoche LCR Sub-area 2032 Forecast Hourly Profiles



**J.3.2.6.1.4 Panoche LCR Sub-area Requirement**

Table J.3.2-43 identifies the sub-area LCR requirements. The LCR Requirement for a Category P6 contingency is 486 MW.



Table J.3.2-43 Panoche LCR Sub-area Requirements

Year	Limit	Category	Limiting Facility	Contingency	LCR (MW) (Deficiency)
2032	First limit	P6	Five Points-Huron-Gates 70 kV line	Panoche 230/115 kV TB #2 and Panoche 230/115 kV TB #3	486 (6 NQC, 59 at Peak)

**J.3.2.6.1.5 Effectiveness factors:**

Effective factors for generators in the Panoche LCR sub-area are in Attachment B table title [Panoche](#).

For other helpful procurement information please read procedure 2210Z Effectiveness Factors under 7430 posted at: <http://www.caiso.com/Documents/2210Z.pdf>

**J.3.2.6.2 Wilson 115 kV Sub-area**

Wilson 115 kV sub-area will be eliminated due to the Wilson #3 230/115 kV transformer coming into service as part of the Wilson 115 kV area reinforcement transmission project.

**J.3.2.6.3 Herndon Sub-area**

Herndon is a sub-area of the Fresno LCR area.

**J.3.2.6.3.1 Herndon LCR Sub-area Diagram**

Figure J.3.2-48 Herndon LCR Sub-area

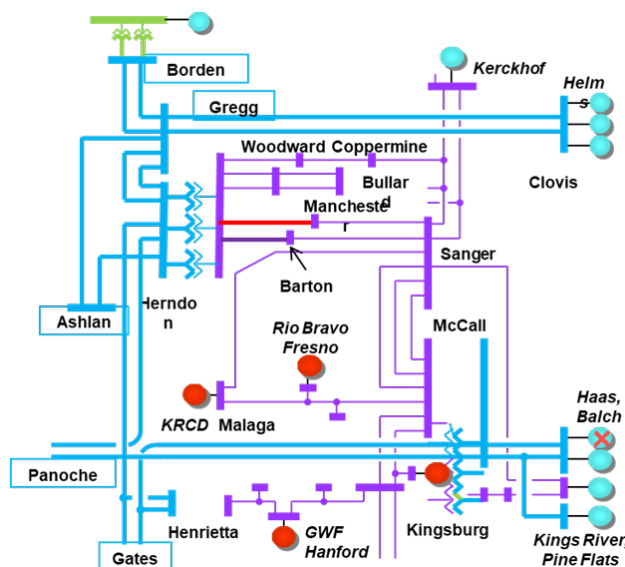

**J.3.2.6.3.2 Herndon LCR Sub-area Load and Resources**

Table J.3.2-44 provides the forecast load and resources in Herndon LCR sub-area in 2032. The list of generators within the LCR sub-area are provided in Attachment A.

Table J.3.2-44 Herndon LCR Sub-area 2032 Forecast Load and Resources

Load (MW)		Generation (MW)	Aug NQC	At Peak
Gross Load	1718	Market, Net Seller	873	873
AAEE	-15	Battery, Hybrid	100	100
Behind the meter DG	0	MUNI, QF	111	111
<b>Net Load</b>	<b>1703</b>	<b>Solar</b>	<b>63</b>	<b>28</b>
Transmission Losses	34	Existing 20-minute Demand Response	0	0
Pumps	0	Mothballed	0	0
<b>Load + Losses + Pumps</b>	<b>1737</b>	<b>Total</b>	<b>1147</b>	<b>1112</b>

**J.3.2.6.3.3 Herndon LCR Sub-area Hourly Profiles**

Figure J.3.2-49 illustrates the forecast 2032 profile for the peak day for the Herndon LCR sub-area with the Category P6 normal and emergency load serving capabilities without local capacity resources. The chart also includes an estimated amount of energy storage that can be added to this local area from charging restriction perspective and the amount of 4-hour storage that can be added to replace local capacity on a 1 MW for 1 MWh basis. Figure J.3.2-50 illustrates the forecast 2032 hourly profile for Herndon LCR sub-area with the Category P6 emergency load serving capability without local capacity resources.

Figure J.3.2-49 Herndon LCR Sub-area 2032 Peak Day Forecast Profiles

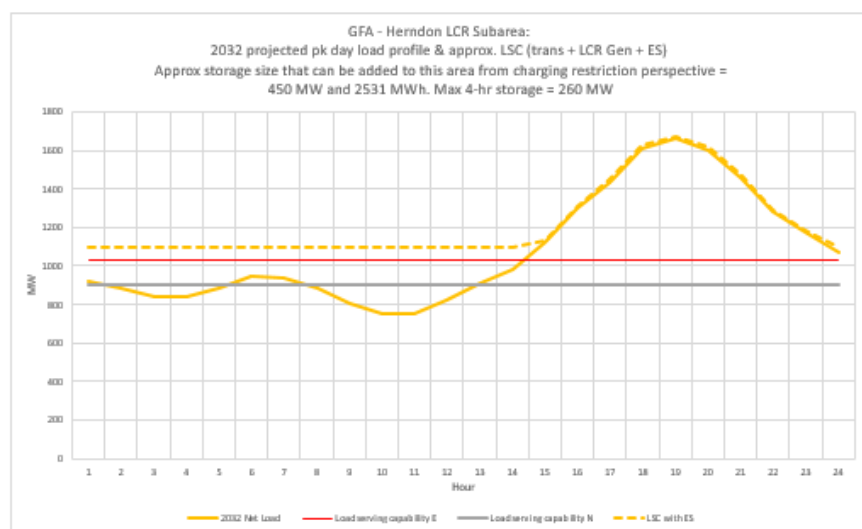
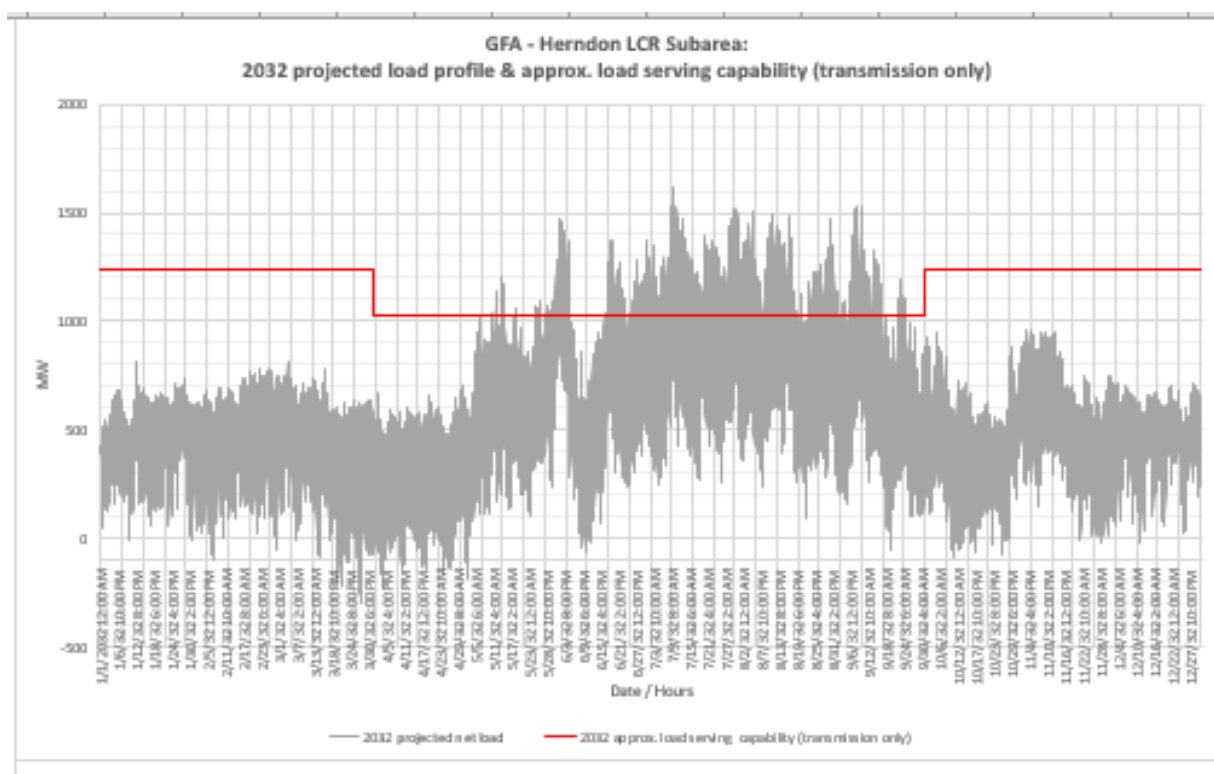

Figure J.3.2-50 Herndon LCR Sub-area 2032 Forecast Hourly Profiles



**J.3.2.6.3.4 Herndon LCR Sub-area Requirement**

Table J.3.2-45 identifies the sub-area LCR requirements. The LCR Requirement for a Category P6 contingency is 644 MW.

Table J.3.2-45 Herndon LCR Sub-area Requirements

Year	Limit	Category	Limiting Facility	Contingency	LCR (MW) (Deficiency)
2032	First limit	P6	Herndon 230/115kV bank 3	Herndon 230/115kV Bank 1 and Bank 2	644

**J.3.2.6.3.5 Effectiveness factors:**

Effectiveness factors for generators in the Herndon LCR sub-area are in Attachment B table titled [Herndon](#).

For other helpful procurement information please read procedure 2210Z Effectiveness Factors under 7430 posted at: <http://www.caiso.com/Documents/2210Z.pdf>

**J.3.2.6.4 Fresno Area Overall**

**J.3.2.6.4.1 Fresno Overall Area Diagram**

Figure J.3.2-51 Fresno Overall LCR Area

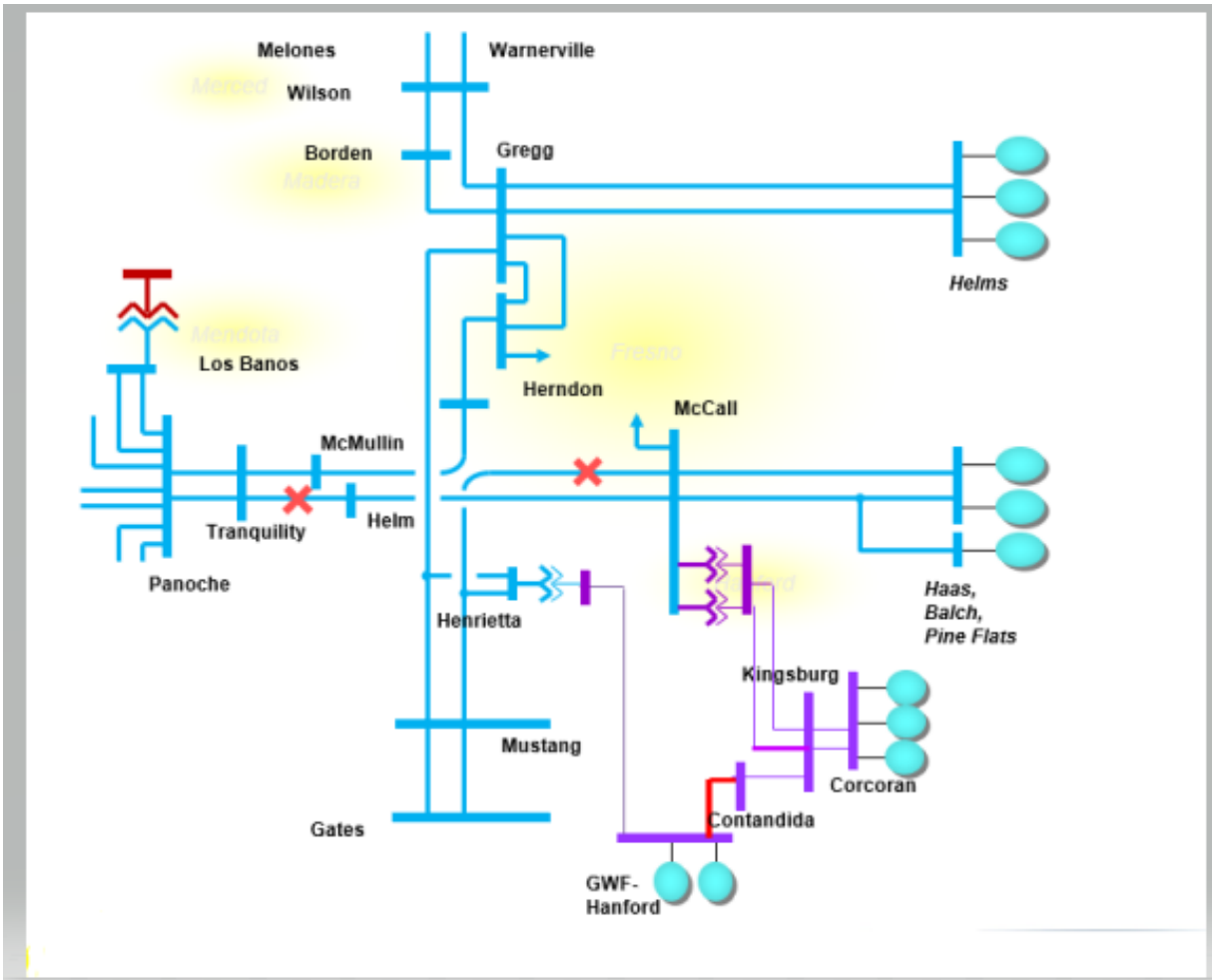

**J.3.2.6.4.2 Fresno Overall LCR Area Load and Resources**

Table 3.2-35 provides the forecast load and resources in Fresno LCR area in 2032. The list of generators within the LCR area are provided in Attachment A.

**J.3.2.6.4.3 Fresno Overall LCR Area Hourly Profiles**

Figure J.3.2-52 illustrates the forecast 2032 profile for the peak day for the overall LCR area with the Category P6 normal and emergency load serving capabilities without local capacity resources. The chart also includes an estimated amount of energy storage that can be added to this local area from charging restriction perspective and the amount of 4-hour storage that can be added to replace local capacity on a 1 MW for 1 MW basis

Figure J.3.2-53 illustrates the forecast 2032 hourly profile for overall LCR area with the Category P6 emergency load serving capability without local capacity resources.

Figure J.3.2-52 Greater Fresno Overall LCR Area 2032 Peak Day Forecast Profiles

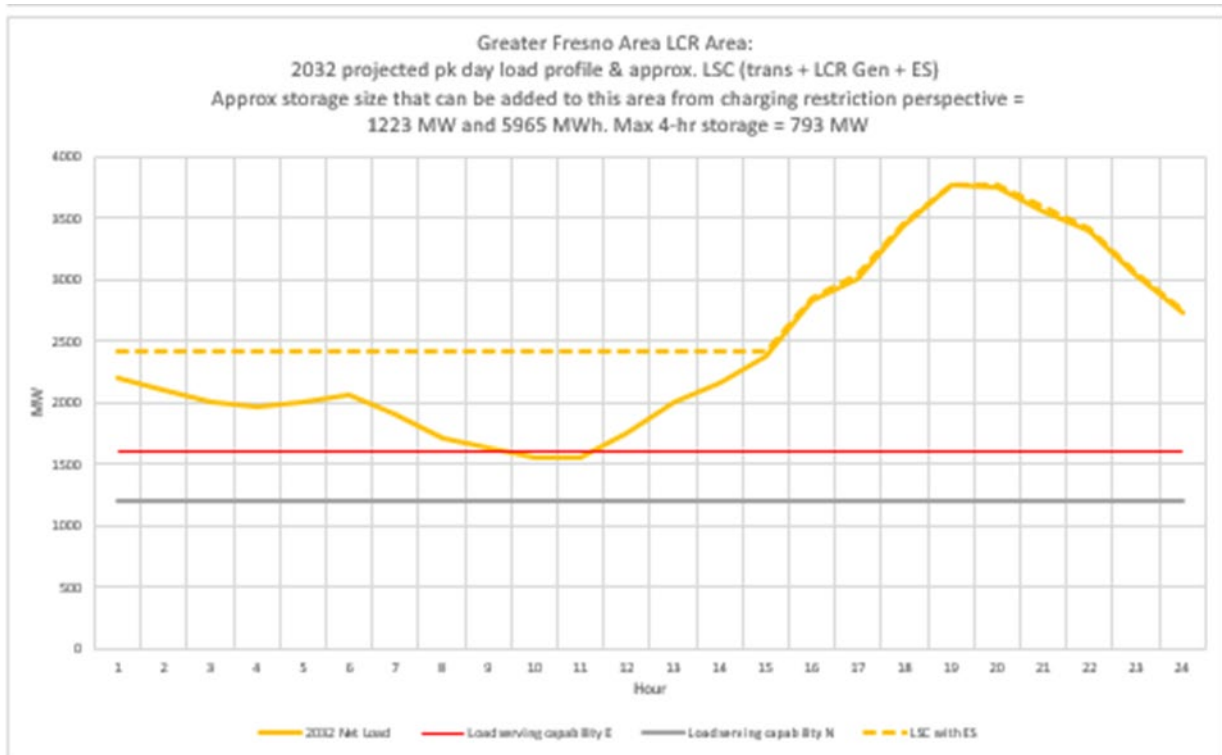
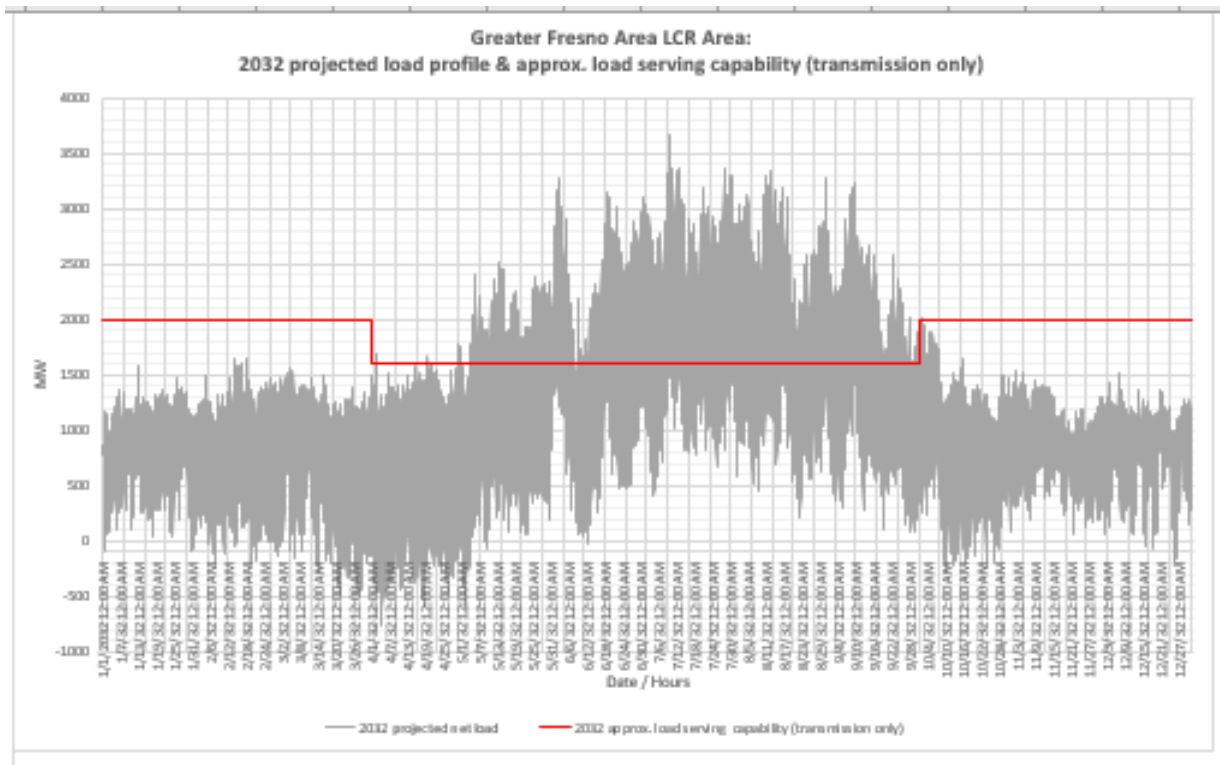

Figure J.3.2-53 Greater Fresno Overall LCR Area 2032 Forecast Hourly Profiles



**J.3.2.6.4.4 Fresno Overall LCR Sub-area Requirement**

Table J.3.2-46 identifies the area LCR requirements. The LCR requirement Category P6 contingency is 2750 MW.

Table J.3.2-46 Fresno Overall LCR Area Requirements

Year	Limit	Category	Limiting Facility	Contingency	LCR (MW) (Deficiency)
2032	First limit	P6	GWF-Contadina 115 kV Line	Panoche-Helm 230 kV Line and CHSR09 Station-Mustang 230 kV line	2750

**J.3.2.6.4.5 Effectiveness factors:**

For most helpful procurement information please read procedure 2210Z Effectiveness Factors under 7430 posted at: <http://www.caiso.com/Documents/2210Z.pdf>

**J.3.2.6.4.6 Changes compared to the 2027 LCT study**

The load forecast increased by 521 MW and the LCR has increased by 571 MW, due to load increase.

**J.3.2.7 Kern Area****J.3.2.7.1 Area Definition:**

The transmission facilities coming into the Kern PP sub-area are:

- Midway-Kern PP #1 230 kV Line
- Midway-Kern PP #2 230 kV Line
- Midway-Kern PP #3 230 kV Line
- Midway-Kern PP #4 230 kV Line
- Wind Gap-Wheeler Ridge #1 230 kV Line
- Wind Gap-Wheeler Ridge #2 230 kV Line
- Famoso-Lerdo 115 kV Line (Normal Open)
- Wasco-Famoso 70 kV Line (Normal Open)
- Copus-Old River 70 kV Line (Normal Open)
- Copus-Old River 70 kV Line (Normal Open)
- Weedpatch CB 32 70 kV (Normal Open)

The substations that delineate the Kern-PP sub-area are:

- Midway 230 kV is out and Bakersfield 230 kV is in
- Midway 230 kV is out Kern PP 230 kV is in
- Midway 230 kV is out and Stockdale 230 kV is in
- Midway 230 kV is out Kern PP 230 kV is in
- Wind Gap 230 kV is out Wheeler Ridge 230 kV is in
- Wind Gap 230 kV is out Wheeler Ridge 230 kV is in
- Famoso 115 kV is out Cawelo 115 kV is in
- Wasco 70 kV is out Mc Farland 70 kV is in
- Copus 70 kV is out, South Kern Solar 70 kV is in
- Lakeview 70 kV is out, San Emidio Junction 70 kV is in
- Weedpatch 70 kV is out, Wellfield 70 kV is in

**J.3.2.7.1.1 Kern LCR Area Diagram**

Figure J.3.2-54 Kern LCR Area

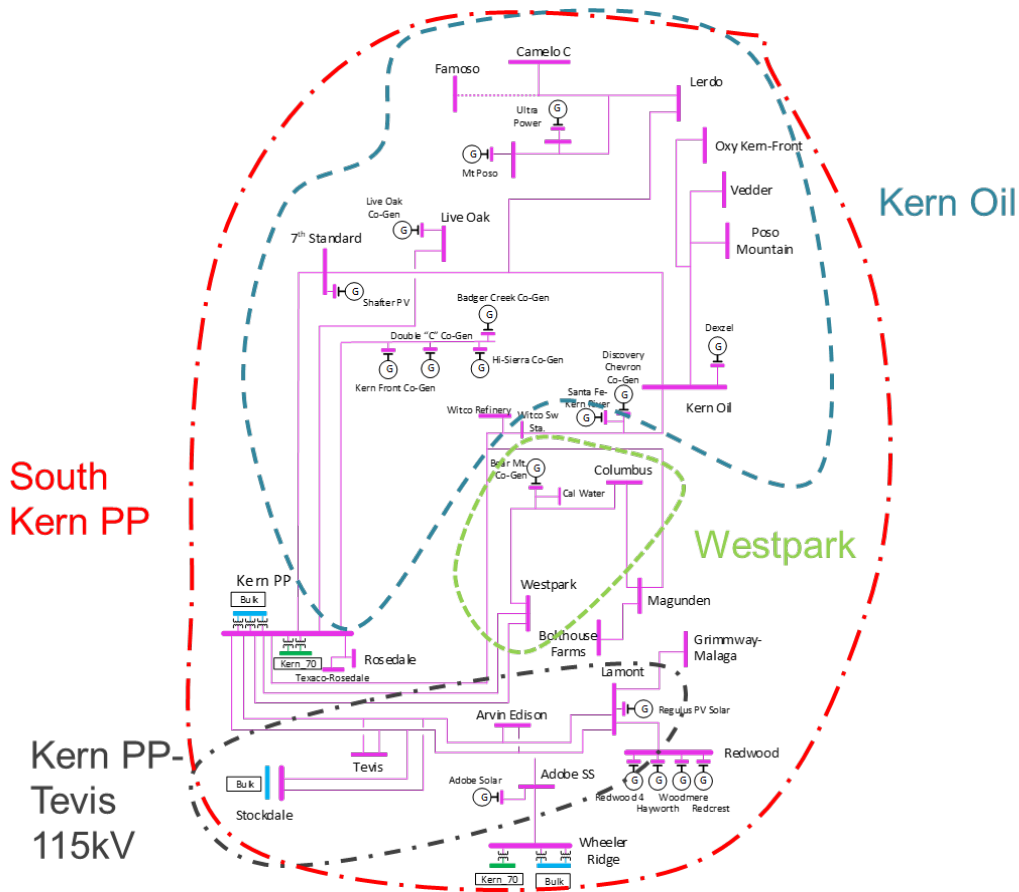

**J.3.2.7.1.2 Kern LCR Area Load and Resources**

Table J.3.2-47 provides the forecast load and resources in Kern LCR area in 2032. The list of generators within the LCR area are provided in Attachment A.

In year 2032 the estimated time of local area peak is 19:00 PM.

At the local area peak time the estimated, ISO metered, solar output is 0.00%.

If required, all non-solar technology type resources are dispatched at NQC.

Table J.3.2-47 Kern LCR Area 2032 Forecast Load and Resources

Load (MW)		Generation (MW)	Aug NQC	At Peak
Gross Load	1015	Market, Net Seller	351	351
AAEE	-15	Battery	95	95
Behind the meter DG	0	MUNI, QF	6	6
<b>Net Load</b>	<b>1000</b>	Solar	75	0
Transmission Losses	11	Existing 20-minute Demand Response	0	0
Pumps	0	Mothballed	0	0
<b>Load + Losses + Pumps</b>	<b>1011</b>	<b>Total</b>	<b>527</b>	<b>452</b>

**J.3.2.7.1.3 Approved transmission projects modeled**

Midway-Temblor 115 kV Line Reconductor & Voltage Support

Bakersfield Nos. 1 and 2 230 kV Tap Lines Reconductoring

Kern PP 115 kV area reinforcement project

**J.3.2.7.2 Kern PP 70 kV Sub-area**

Kern PP 70 kV is a sub-area of the Kern LCR area.

The Kern PP 70 kV Sub-area has been eliminated due to load changes and project modeling changes in the area.

**J.3.2.7.3 Westpark Sub-area**

Westpark is a sub-area of the Kern LCR area.

**J.3.2.7.3.1 Westpark LCR Sub-area Diagram**

Please see Figure 3.2-54 for Westpark sub-area diagram.

**J.3.2.7.3.2 Westpark LCR Sub-area Load and Resources**

Table J.3.2-48 provides the forecast load and resources in Westpark LCR sub-area in 2032.

The list of generators within the LCR sub-area are provided in Attachment A.



Table J.3.2-48 Westpark LCR Sub-area 2032 Forecast Load and Resources

Load (MW)		Generation (MW)	Aug NQC	At Peak
Gross Load	126	Market, Net Seller	45	45
AAEE	-2	Battery	0	0
Behind the meter DG	0	MUNI, QF	0	0
<b>Net Load</b>	<b>124</b>	Solar	0	0
Transmission Losses	0	Existing 20-minute Demand Response	0	0
Pumps	0	Mothballed	0	0
<b>Load + Losses + Pumps</b>	<b>124</b>	<b>Total</b>	<b>45</b>	<b>45</b>

### J.3.2.7.3.3 Westpark LCR Sub-area Hourly Profiles

Figure J.3.2-55 illustrates the forecast 2032 profile for the peak day for the Westpark LCR sub-area with the Category P6 normal and emergency load serving capabilities without local capacity resources. The chart also includes an estimated amount of energy storage that can be added to this local area from charging restriction perspective and the amount of 4-hour storage that can be added to replace local capacity on a 1 MW for 1 MWh basis. Figure J.3.2-56 illustrates the forecast 2032 hourly profile for Westpark LCR sub-area with the Category P6 contingency transmission capability without local capacity resources.

Figure J.3.2-55 Westpark LCR Sub-area 2032 Peak Day Forecast Profiles

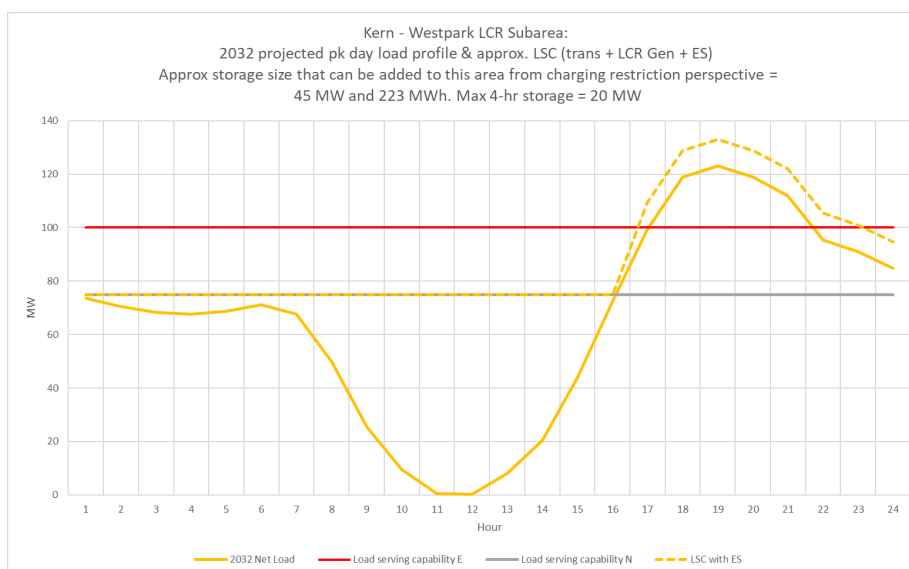
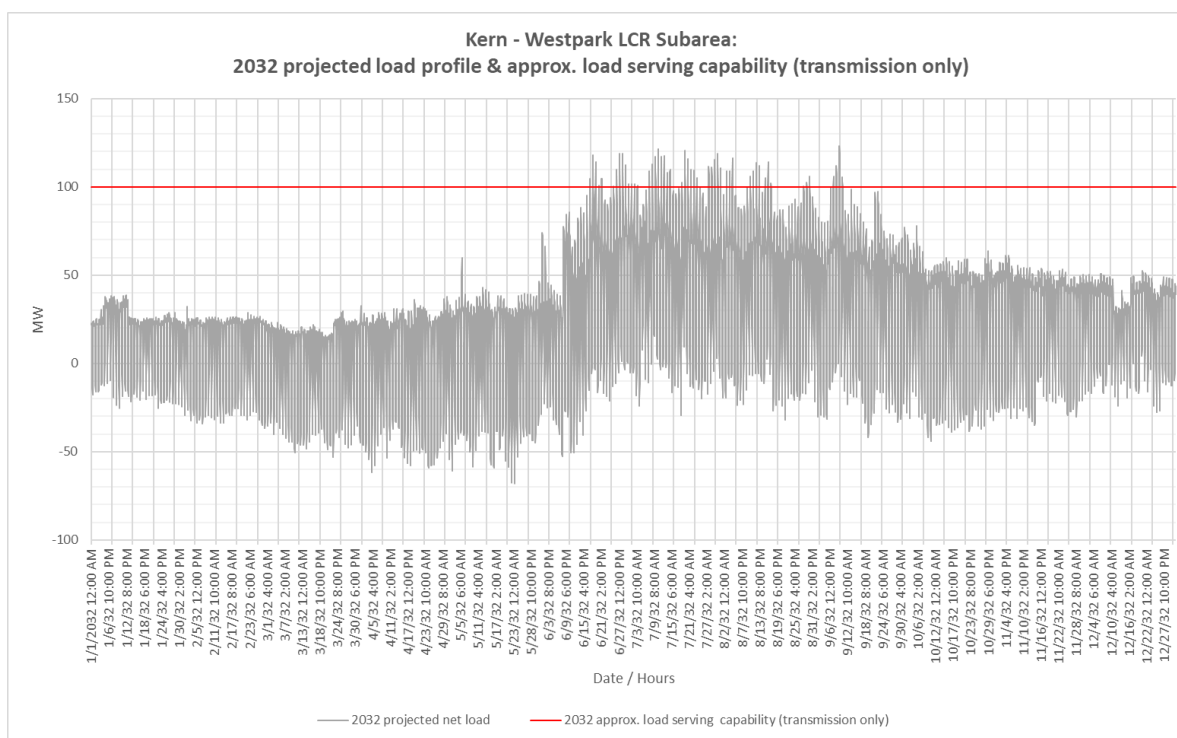

Figure J.3.2-56 Westpark LCR Sub-area 2032 Forecast Hourly Profiles



**J.3.2.7.3.4 Westpark LCR Sub-area Requirement**

Table J.3.2-49 identifies the sub-area LCR requirements. The LCR requirement for Category P7 contingency is 53 MW with a 8 MW deficiency.

Table J.3.2-49 Westpark LCR Sub-area Requirements

Year	Limit	Category	Limiting Facility	Contingency	LCR (MW) (Deficiency)
2032	First Limit	P7	Magunden – Magunden Jct 115 kV line	Kern-West Park #1 & #2 115 kV	53 (8)

**J.3.2.7.3.5 Effectiveness factors:**

All units within the Westpark Sub-area have the same effectiveness factor.

For most helpful procurement information please read procedure 2210Z Effectiveness Factors under 7450 posted at: <http://www.aiso.com/Documents/2210Z.pdf>

**J.3.2.7.4 Kern Oil Sub-area**

Kern Oil is a sub-area of the Kern LCR area.

J.3.2.7.4.1 Kern Oil LCR Sub-area Diagram

Figure J.3.2-57 Kern Oil LCR Sub-area

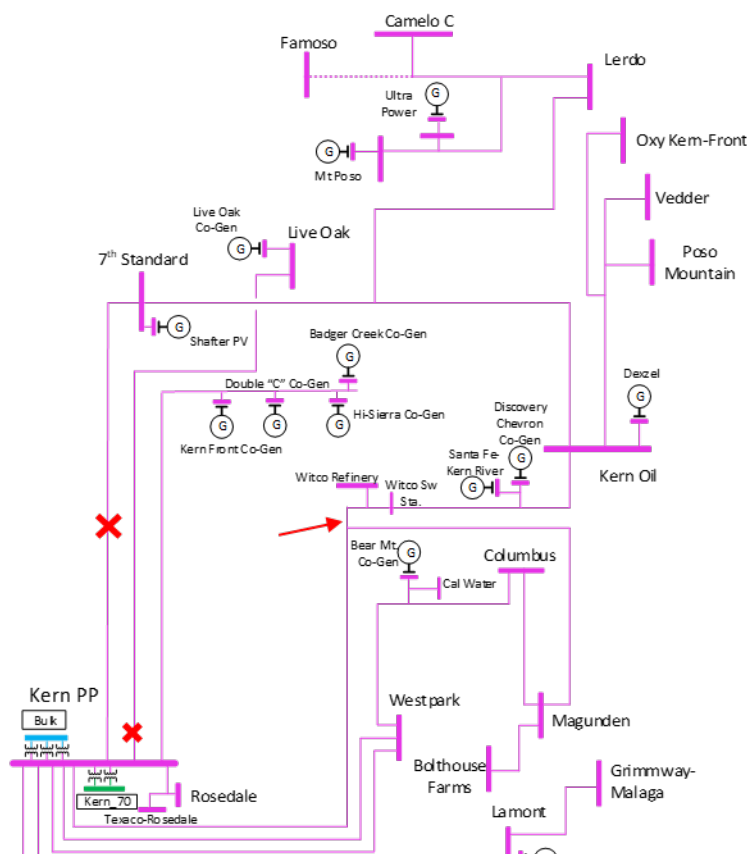

J.3.2.7.4.2 Kern Oil LCR Sub-area Load and Resources

Table J.3.2-50 provides the forecast load and resources in Kern Oil LCR sub-area in 2032. The list of generators within the LCR sub-area are provided in Attachment A.

Table J.3.2-50 Kern Oil LCR Sub-area 2032 Forecast Load and Resources

Load (MW)		Generation (MW)	Aug NQC	At Peak
Gross Load	315	Market, Net Seller	103	103
AAEE	-6	Battery	0	0
Behind the meter DG	0	MUNI, QF	6	6
<b>Net Load</b>	<b>309</b>	Solar	9	0
Transmission Losses	1	Existing 20-minute Demand Response	0	0
Pumps	0	Mothballed	0	0
<b>Load + Losses + Pumps</b>	<b>310</b>	<b>Total</b>	<b>118</b>	<b>109</b>

**J.3.2.7.4.3 Kern Oil LCR Sub-area Hourly Profiles**

Figure J.3.2-58 illustrates the forecast 2032 profile for the peak day for the Kern Oil LCR sub-area with the Category P6 normal and emergency load serving capabilities without local capacity resources. The chart also includes an estimated amount of energy storage that can be added to this local area from charging restriction perspective and the amount of 4-hour storage that can be added to replace local capacity on a 1 MW for 1 MWh basis. Figure J.3.2-59 illustrates the forecast 2032 hourly profile for Kern Oil LCR sub-area with the Category P6 contingency transmission capability without local capacity resources.

Figure J.3.2-58 Kern Oil LCR Sub-area 2032 Peak Day Forecast Profiles

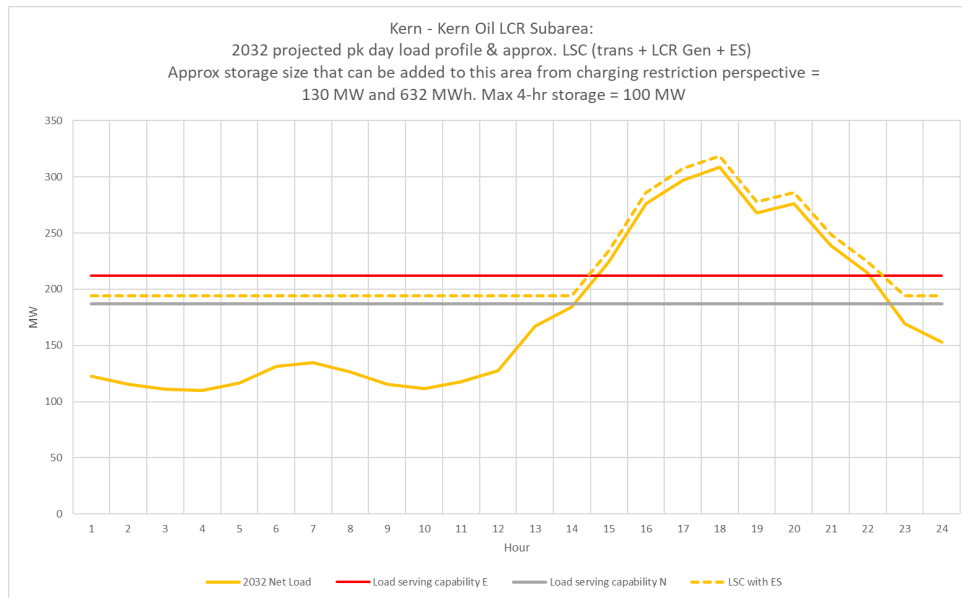
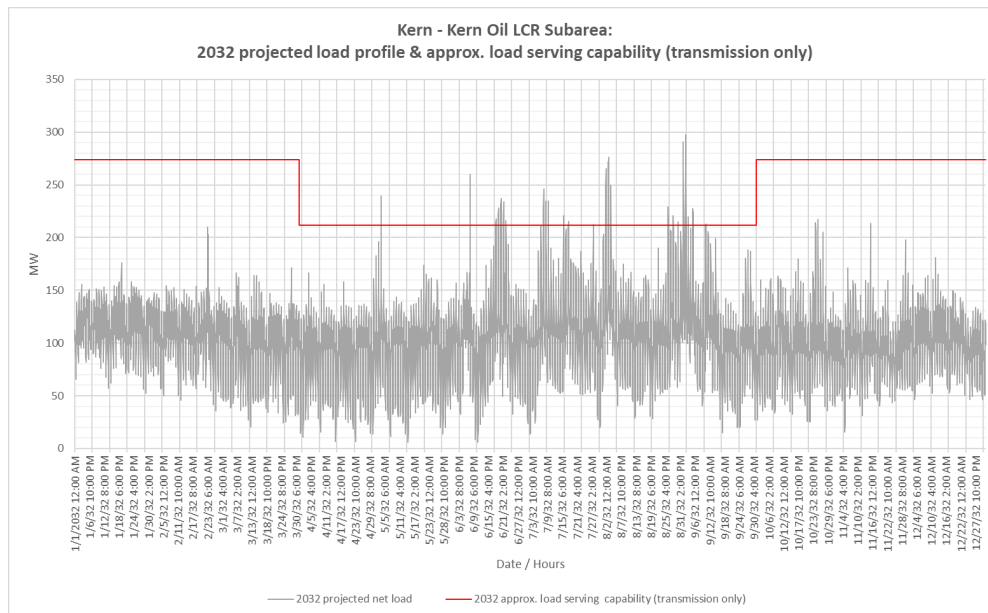

Figure J.3.2-59 Kern Oil LCR Sub-area 2032 Forecast Hourly Profiles



**J.3.2.7.4.4 Kern Oil LCR Sub-area Requirement**

Table J.3.2-51 identifies the sub-area LCR requirements. The LCR requirement for Category Category P6 contingency LCR requirement is 137 MW with a 17 MW NQC deficiency (28 MW peak deficiency).

Table J.3.2-51 Kern Oil LCR Sub-area Requirements

Year	Limit	Category	Limiting Facility	Contingency-	LCR (MW) (Deficiency)
2032	First Limit	P6	Kern Power to Kern Water 115 kV line section	Kern PP-7th Standard 115 kV lines & Kern PP-Live Oak 115 kV Line	137 (17 NQC/28 Peak)

**J.3.2.7.4.5 Effectiveness factors:**

All units within the Kern Oil Sub-area have the same effectiveness factor.

For most helpful procurement information please read procedure 2210Z Effectiveness Factors under 7450 posted at: <http://www.caiso.com/Documents/2210Z.pdf>

**J.3.2.7.5 Kern PP-Tevis 115 kV Sub-area**

Kern PP-Tevis 115 kV is a sub-area of the Kern LCR area.

**J.3.2.7.5.1 Kern PP-Tevis 115 kV LCR Sub-area Diagram**

Figure J.3.2-60 Kern PP-Tevis 115 kV LCR Sub-area

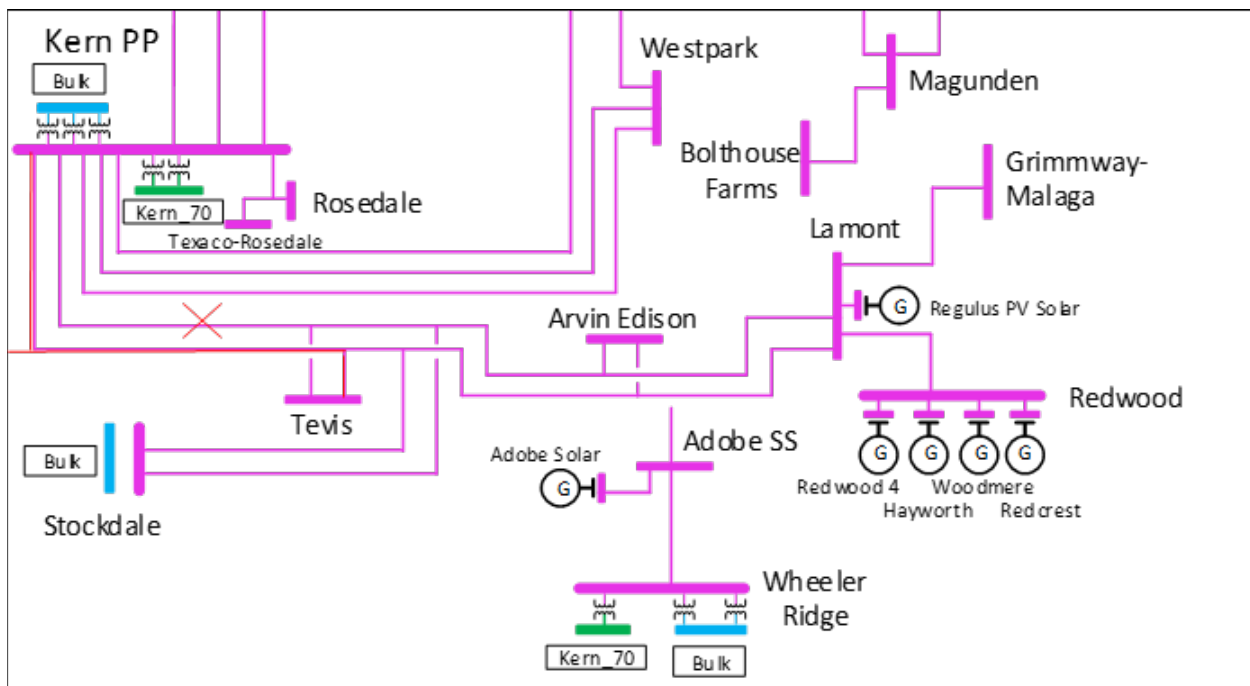

**J.3.2.7.5.2 Kern PP-Tevis 115 kV LCR Sub-area Load and Resources**

Table J.3.2-52 provides the forecast load and resources in Kern PP-Tevis LCR sub-area in 2032. The list of generators within the LCR sub-area are provided in Attachment A.

Table J.3.2-52 Kern PP-Tevis LCR Sub-area 2032 Forecast Load and Resources

Load (MW)		Generation (MW)	Aug NQC	At Peak
Gross Load	151	Market, Net Seller	0	0
AAEE	-1	Battery	95	95
Behind the meter DG	0	MUNI, QF	0	0
<b>Net Load</b>	<b>150</b>	Solar	52	0
Transmission Losses	0	Existing 20-minute Demand Response	0	0
Pumps	0	Mothballed	0	0
<b>Load + Losses + Pumps</b>	<b>150</b>	<b>Total</b>	<b>147</b>	<b>95</b>

**J.3.2.7.5.3 Kern PP-Tevis 115 kV LCR Sub-area Hourly Profiles**

Energy storage chart for the Kern PP-Tevis 115 kV sub-area is not provided because there is no LCR resource at the peak. As such, no non-battery resource is available for displacement for assessment of the additional energy storage estimation from the charging restriction perspective.

**J.3.2.7.5.4 Kern PP-Tevis 115 kV LCR Sub-area Requirement**

Table J.3.2-53 identifies the sub-area LCR requirements. The LCR requirement for Category Category P2 contingency LCR requirement is 24 MW.

Table J.3.2-53 Kern pp-Tevis LCR Sub-area Requirements

Year	Limit	Category	Limiting Facility	Contingency-	LCR (MW) (Deficiency)
2032	First Limit	P2	Kern Power -TevisJ2 115 kV Line	Kern-Tevis-Stockdale 115 kV (Kern Pwr-Tevis J1 section)	24

**J.3.2.7.5.5 Effectiveness factors:**

All units within the Kern PP-Tevis 115 kV Sub-area have the same effectiveness factor.

For most helpful procurement information please read procedure 2210Z Effectiveness Factors under 7450 posted at: <http://www.aiso.com/Documents/2210Z.pdf>

**J.3.2.7.6 South Kern PP Sub-area**

South Kern PP is a sub-area of the Kern LCR area.

**J.3.2.7.6.1 South Kern PP LCR Sub-area Diagram**

Figure J.3.2-61 South Kern PP LCR Sub-area

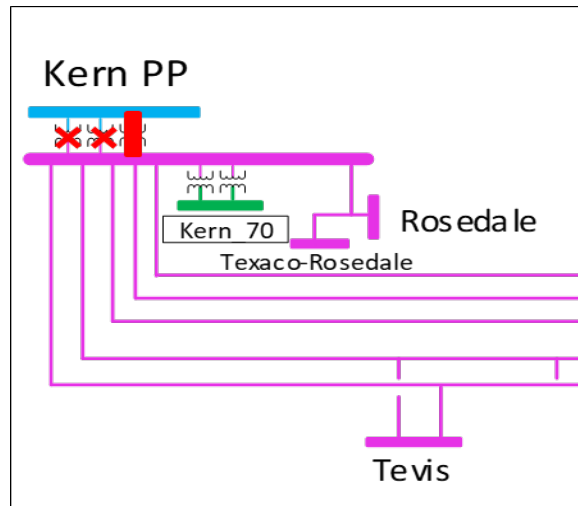

**J.3.2.7.6.2 South Kern PP LCR Sub-area Load and Resources**

Refer to Table 3.2-47 Kern Area Load and Resources table.

**J.3.2.7.6.3 South Kern PP LCR Sub-area Hourly Profiles**

Figure J.3.2-62 illustrates the forecast 2032 profile for the summer peak, winter peak and spring off-peak days for the South Kern PP LCR sub-area with the Category P6 contingency transmission capability without resources. Figure J.3.2-63 illustrates the forecast 2032 hourly profile for South Kern PP LCR sub-area with the Category P6 contingency transmission capability without resources.

Figure J.3.2-62 South Kern PP LCR Sub-area 2032 Peak Day Forecast Profiles

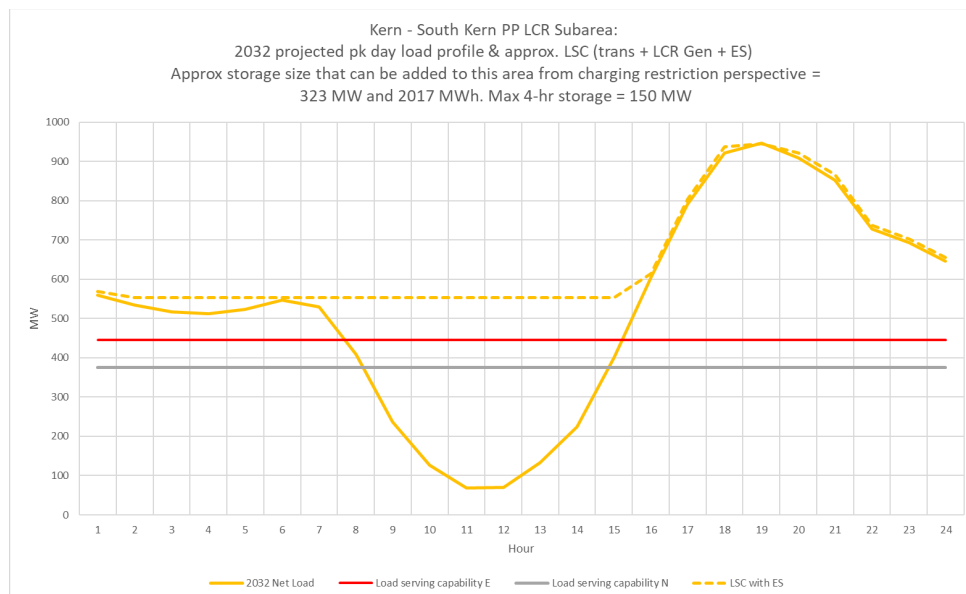
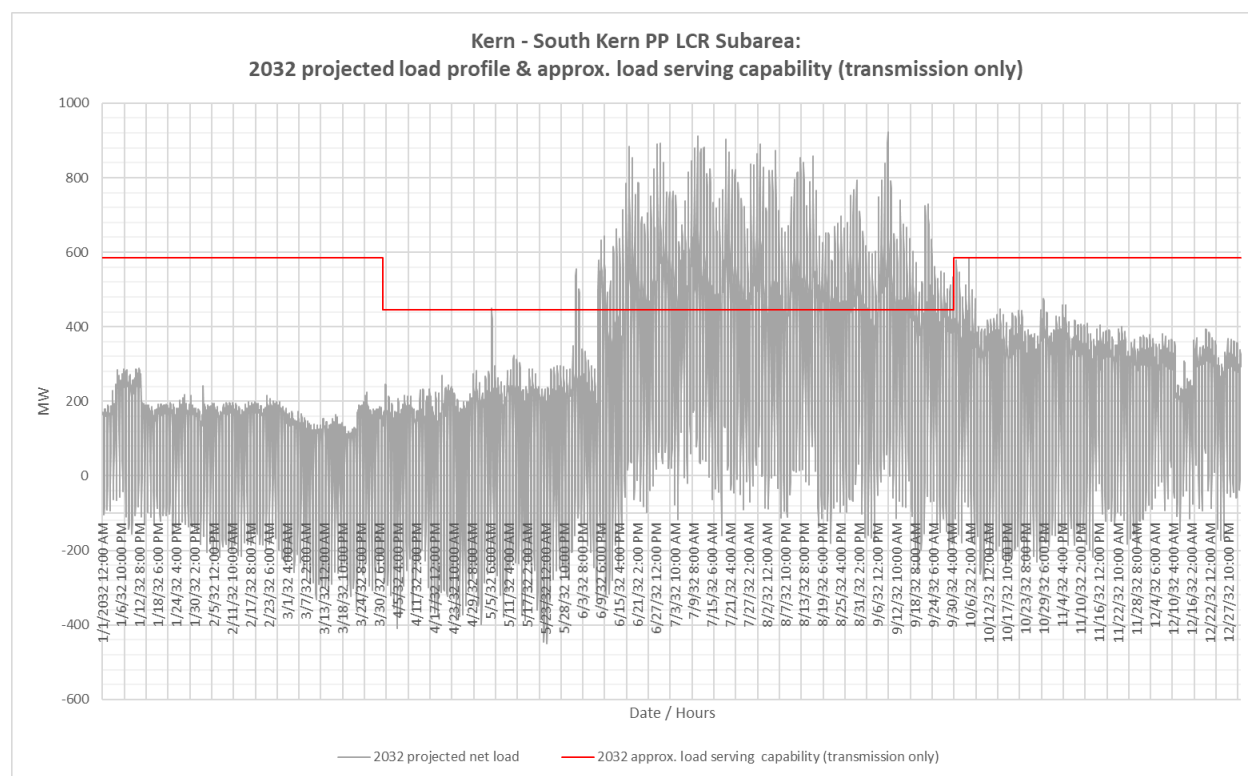

Figure J.3.2-63 South Kern Overall LCR Area 2032 Forecast Hourly Profiles



**J.3.2.7.6.4 South Kern PP LCR Sub-area Requirement**

Table J.3.2-54 identifies the sub-area LCR requirements. The LCR requirement for Category P6 contingency is 424 MW.

Table J.3.2-54 South Kern PP LCR Sub-area Requirements

Year	Limit	Category	Limiting Facility	Contingency	LCR (MW) (Deficiency)
2032	First Limit	P6	Kern 230/115 kV T/F # 5	Kern 230/115 kV T/F # 3 & Kern 230/115 kV T/F # 4	424

**J.3.2.7.6.5 Effectiveness factors:**

For most helpful procurement information please read procedure 2210Z Effectiveness Factors under 7450 posted at: <http://www.caiso.com/Documents/2210Z.pdf>

**J.3.2.7.7 Kern Area Overall Requirements**

**J.3.2.7.7.1 Kern LCR Area Overall Requirement**

Table J.3.2-55 identifies the limiting facility and contingency that establishes the Kern Area 2032 LCR requirements. The LCR requirement for Category P6 contingency the LCR requirement is 424 MW with a 25 MW NQC deficiency or 36 MW of at peak deficiency.



Table J.3.2-55 Kern Overall LCR Sub-area Requirements

Year	Limit	Category	Limiting Facility	Contingency	LCR (MW) (Deficiency)
2032	N/A	P6	Aggregate of Sub-areas.		449 (25 NQC/ 36 Peak)

### J.3.2.7.7.2 Changes compared to the 2027 LCT study

Compared to the 2027, the load has increased by 73 MW and the LCR requirement has increased by 133 MW due to load forecast increase.

## J.3.2.8 Big Creek/Ventura Area

### J.3.2.8.1 Area Definition:

The transmission tie lines into the Big Creek/Ventura Area are:

- Antelope #1 500/230 kV Transformer
- Antelope #2 500/230 kV Transformer
- Sylmar - Pardee 230 kV #1 and #2 Lines
- Vincent - Pardee 230 kV #2 Line
- Vincent - Santa Clara 230 kV Line

The substations that delineate the Big Creek/Ventura Area are:

- Antelope 500 kV is out Antelope 230 kV is in
- Antelope 500 kV is out Antelope 230 kV is in
- Sylmar is out Pardee is in
- Vincent is out Pardee is in
- Vincent is out Santa Clara is in

**J.3.2.8.1.1 Big Creek/Ventura LCR Area Diagram**

Figure J.3.2-64 Big Creek/Ventura LCR Area

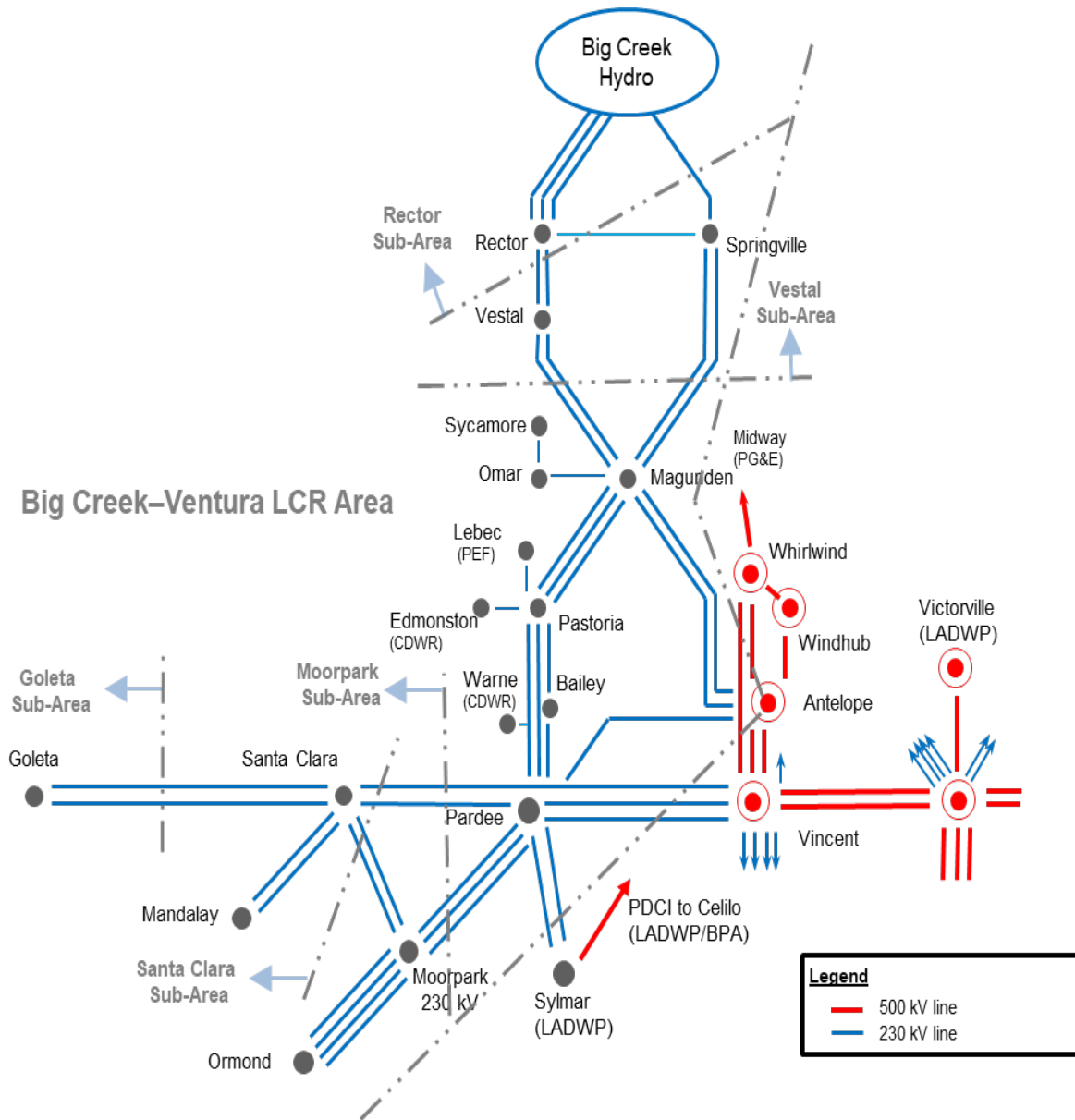

**J.3.2.8.1.2 Big Creek/Ventura LCR Area Load and Resources**

Table J.3.2-56 provides the forecast load and resources in the Big Creek/Ventura LCR area in 2032. The list of generators within the LCR area are provided in Attachment A and does not include new LTPP Preferred resources or existing DR.

In year 2032 the estimated time of local area peak is hour ending 19:00 PST (HE 20:00 PDT).

At the local area peak time the estimated, ISO-metered solar output is 0.0%.

If required, all non-solar technology type resources are dispatched at NQC.

Table J.3.2-56 Big Creek/Ventura LCR Area 2032 Forecast Load and Resources

Load (MW)		Generation (MW)	Aug NQC	At Peak
Gross Load	4560	Market, Net Seller, Wind	2491	2491
AEE	-97	Battery	1677	1677
Behind the meter DG	0	MUNI, QF	407	407
<b>Net Load</b>	<b>4463</b>	Solar	531	0
Transmission Losses	93	Other preferred resources and storage	0	0
Pumps	298	Existing Demand Response	70	70
<b>Load + Losses + Pumps</b>	<b>4854</b>	<b>Total</b>	<b>5176</b>	<b>4645</b>

**J.3.2.8.1.3 Approved transmission projects modeled:**

Pardee-Moorpark No. 4 230 kV Transmission Circuit (ISD – 6/1/2021)

Pardee-Sylmar 230 kV Rating Increase Project (ISD- 5/31/2023)

**J.3.2.8.2 Rector Sub-area**

LCR need is satisfied by the need in the larger Vestal sub-area.

**J.3.2.8.3 Vestal Sub-area**

Vestal is a sub-area of the Big Creek/Ventura LCR area.

**J.3.2.8.3.1 Vestal LCR Sub-area Diagram**

Figure J.3.2-65 Vestal LCR Sub-area

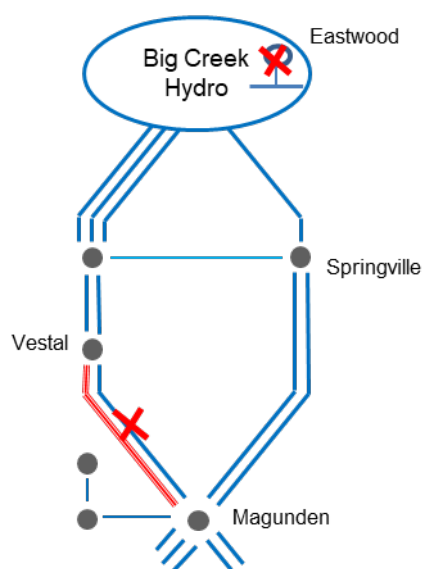

**J.3.2.8.3.2 Vestal LCR Sub-area Load and Resources**

Table J.3.2-57 provides the forecast load and resources in Vestal LCR sub-area in 2032. The list of generators within the LCR sub-area is provided in Attachment A.

Table J.3.2-57 Vestal LCR Sub-area 2032 Forecast Load and Resources

Load (MW)		Generation (MW)	Aug NQC	At Peak
Gross Load	1287	Market, Net Seller, Wind	972	972
AAEE	-29	Battery	300	300
Behind the meter DG	0	MUNI, QF	12	12
<b>Net Load</b>	<b>1258</b>	Solar	119	0
Transmission Losses	22	Other preferred resources and storage	0	0
Pumps	0	Existing 20-minute Demand Response	30	30
<b>Load + Losses + Pumps</b>	<b>1280</b>	<b>Total</b>	<b>1433</b>	<b>1314</b>

**J.3.2.8.3.3 Vestal LCR Sub-area Hourly Profiles**

Figure J.3.2-66 illustrates the forecast 2032 profile for the peak day for the Vestal LCR sub-area along with the Category P3 normal and emergency load serving capabilities without local capacity resources. The chart also includes an estimated amount of energy storage that can be added to this local area from charging restriction perspective and the amount of 4-hour storage that can be added to replace local capacity on a 1 MW for 1 MWh basis. Figure J.3.2-67 illustrates the forecast 2032 hourly profile for Vestal LCR sub-area along with the Category P3 emergency load serving capability without local capacity resources.

Figure J.3.2-66 Vestal LCR Sub-area 2032 Peak Day Forecast Profiles

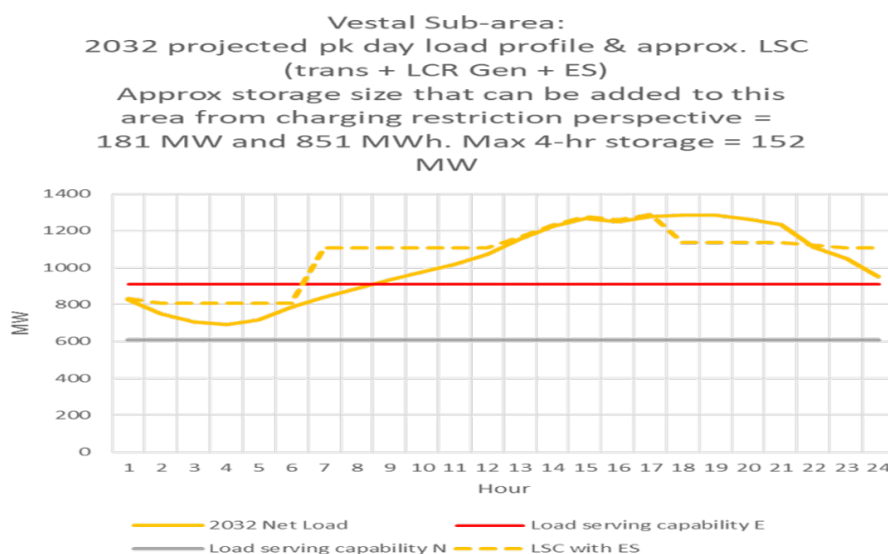
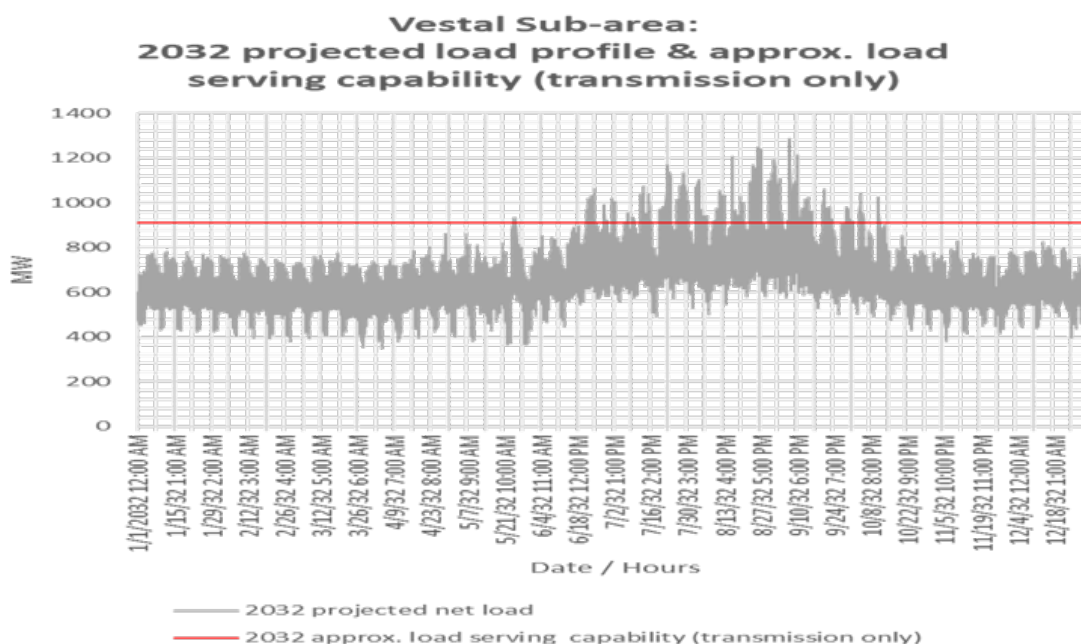

Figure J.3.2-67 Vestal Sub-area 2032 Forecast Hourly Profile



**J.3.2.8.3.4 Vestal LCR Sub-area Requirement**

Table J.3.2-58 identifies the sub-area LCR requirements. The 2032 LCR requirement for Category P3 contingency is 376 MW.

Table J.3.2-58 Vestal LCR Sub-area Requirements

Year	Limit	Category	Limiting Facility	Contingency	LCR (MW) (Deficiency)
2032	First Limit	P3	Magunden–Vestal #1 230 kV line	Magunden–Vestal #2 line with Eastwood out of service	376

**J.3.2.8.3.5 Effectiveness factors:**

For helpful procurement information please read procedure 2210Z Effectiveness Factors under 7500 posted at: <http://www.aiso.com/Documents/2210Z.pdf>

**J.3.2.8.4 Goleta Sub-area**

Goleta is a sub-area of the Big Creek/Ventura LCR area.

The LCR need is satisfied by the need in the larger Santa Clara sub-area.

**J.3.2.8.5 Santa Clara Sub-area**

Santa Clara is a sub-area of the Big Creek/Ventura LCR area.

**J.3.2.8.5.1 Santa Clara LCR Sub-area Diagram**

Figure J.3.2-68 Santa Clara LCR Sub-area

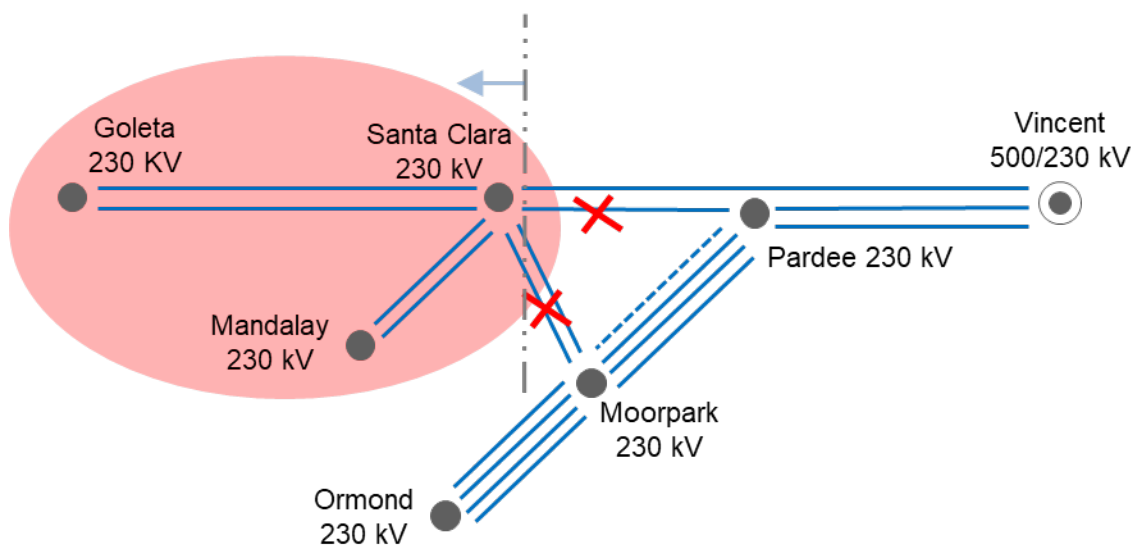

**J.3.2.8.5.2 Santa Clara LCR Sub-area Load and Resources**

Table J.3.2-59 provides the forecast load and resources in Santa Clara LCR sub-area in 2032. The list of generators within the LCR sub-area are provided in Attachment A.

Table J.3.2-59 Santa Clara LCR Sub-area 2032 Forecast Load and Resources

Load (MW)		Generation (MW)		Aug NQC	At Peak
Gross Load	892	Market		93	93
AAEE	-18	Battery		221	221
Behind the meter DG	0	MUNI, QF		88	88
<b>Net Load</b>	<b>874</b>	Solar		0	0
Transmission Losses	4	Existing Demand Response		6	6
Pumps	0	Other preferred resources and storage		0	0
<b>Load + Losses + Pumps</b>	<b>878</b>	<b>Total</b>		<b>408</b>	<b>408</b>

**J.3.2.8.5.3 Santa Clara LCR Sub-area Hourly Profiles**

Figure J.3.2-69 illustrates the forecast 2032 profile for the peak day for the Santa Clara sub-area along with the Category P1+P7 load serving capability without local capacity resources. The chart also includes an estimated amount of energy storage that can be added to this local area from charging restriction perspective and the amount of 4-hour storage that can be added to replace local capacity on a 1 MW for 1 MW basis. Figure J.3.2-70 illustrates the forecast 2032 hourly

profile for Santa Clara sub-area along with the Category P1+P7 emergency load serving capability without local capacity resources.

Figure J.3.2-69 Santa Clara LCR Sub-area 2032 Peak Day Forecast Profiles

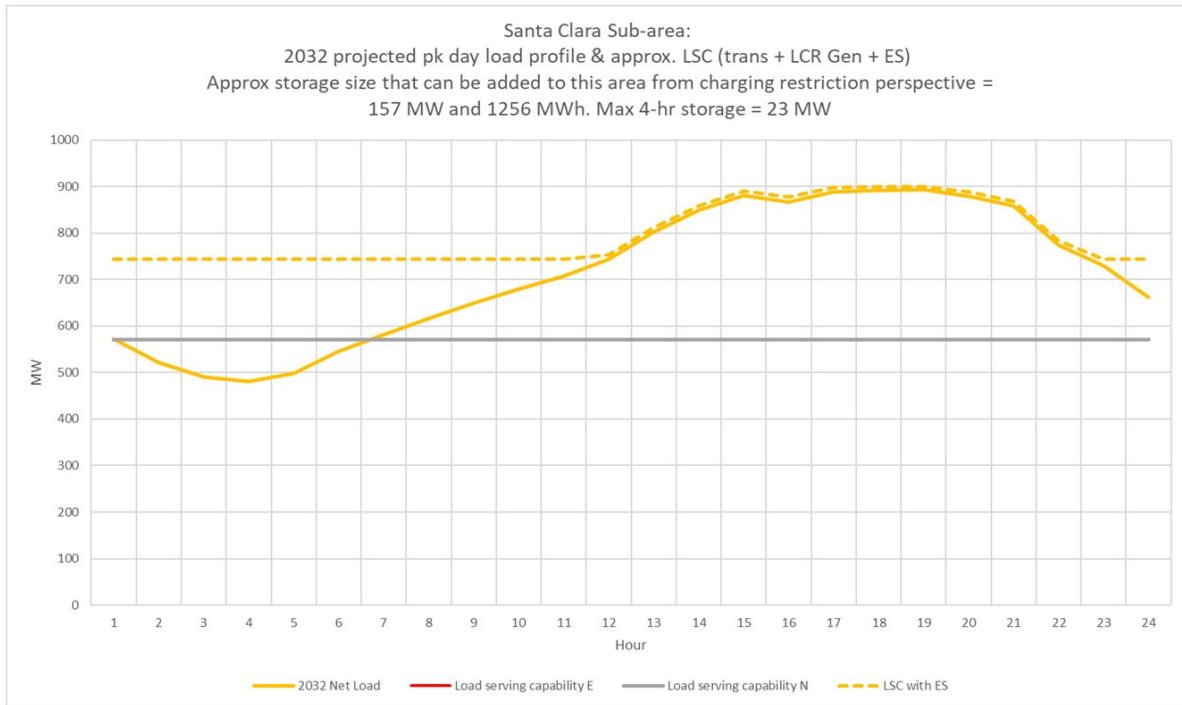
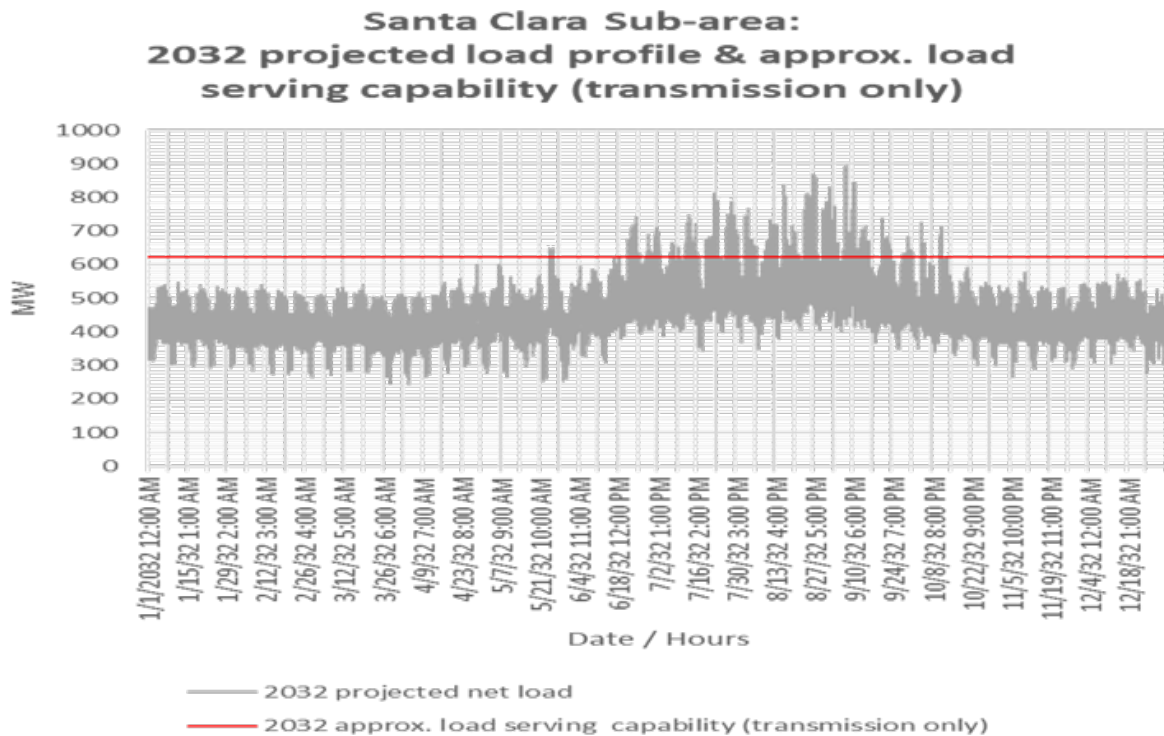

Figure J.3.2-70 Santa Clara Sub-area 2032 Forecast Hourly Profiles



**J.3.2.8.5.4 Santa Clara LCR Sub-area Requirement**

Table J.3.2-60 identifies the sub-area requirement. The 2032 LCR requirement for Category P1 + P7 contingency is 274 MW.

Table J.3.2-60 Santa Clara LCR Sub-area Requirements

Year	Limit	Category	Limiting Facility	Contingency	LCR (MW) (Deficiency)
2032	First Limit	P1 + P7	Voltage collapse	Pardee - Santa Clara 230 kV followed by Moorpark - Santa Clara #1 & #2 230 kV	274

**J.3.2.8.5.5 Effectiveness factors:**

For helpful procurement information please read procedure 2210Z Effectiveness Factors under 7500, 7510, 7550, 7680 and 8610 posted at: <http://www.caiso.com/Documents/2210Z.pdf>

**J.3.2.8.6 Moorpark Sub-area**

Moorpark is a sub-area of the Big Creek/Ventura LCR area.

No requirement is identified for the sub-area due to the Pardee-Moorpark No. 4 230 kV Transmission Project.

**J.3.2.8.7 Big Creek/Ventura Overall****J.3.2.8.7.1 Big Creek/Ventura LCR Sub-area Hourly Profiles**

Figure J.3.2-71 illustrates the forecast 2032 profile for the peak day for Big Creek/Ventura area along with the Category P6 normal and emergency load serving capability without local capacity resources. The chart also includes an estimated amount of energy storage that can be added to this local area from charging restriction perspective and the amount of 4-hour storage that can be added to replace local capacity on a 1 MW for 1 MW basis. Figure J.3.2-72 illustrates the forecast 2032 hourly profile for Santa Clara sub-area along with the Category P6 emergency load serving capability without local capacity resources.



Figure J.3.2-71 Big Creek/Ventura LCR area 2032 Peak Day Forecast Profiles

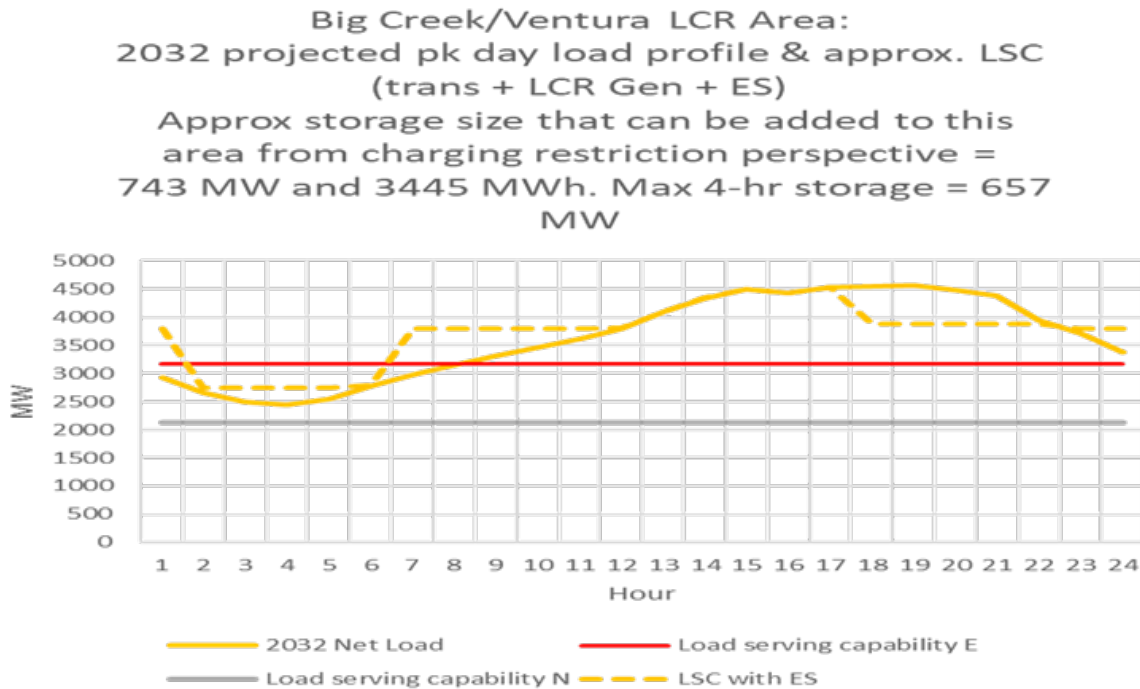
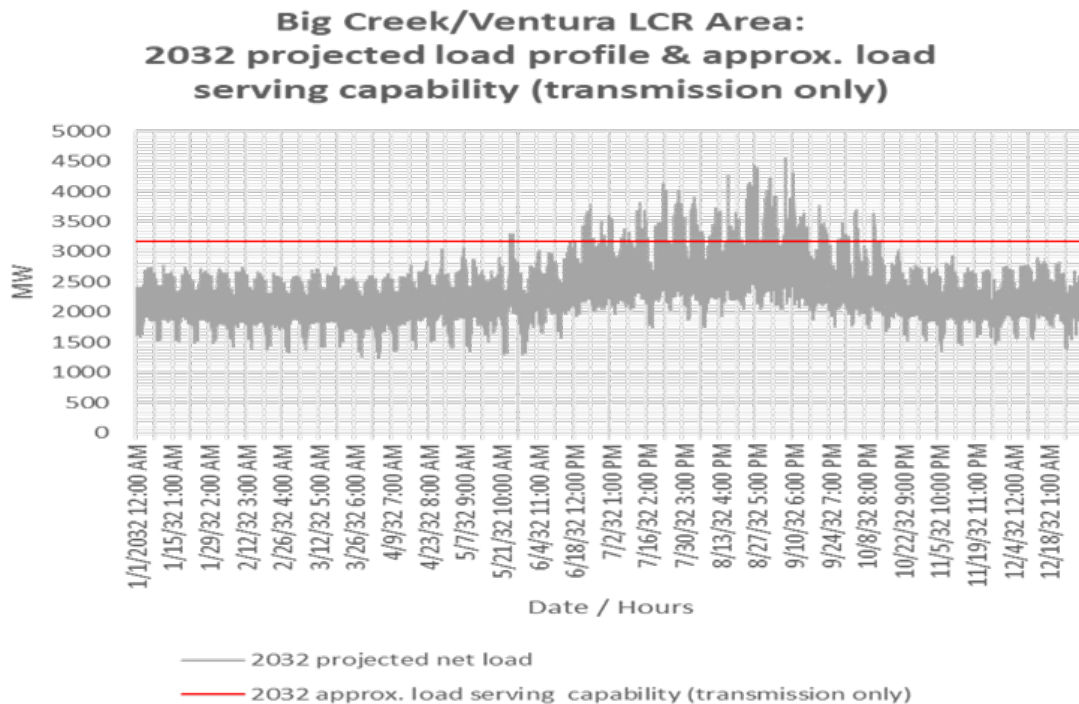

Figure J.3.2-72 Big Creek/Ventura LCR area 2032 Peak Day Forecast Profiles



**J.3.2.8.7.2 Big Creek/Ventura LCR area Requirement**

Table J.3.2-61 identifies the area LCR requirements. The LCR requirement for Category P6 contingency is 1,366 MW.

Table J.3.2-61 Big Creek/Ventura LCR area Requirements

Year	Limit	Category	Limiting Facility	Contingency	LCR (MW)
2032	First limit	P6	Remaining Sylmar - Pardee 230 kV	Lugo - Victorville 500 kV line followed by one of the Sylmar - Pardee #1 or #2 230 kV lines	1366

**J.3.2.8.7.3 Effectiveness factors:**

For helpful procurement information please read procedure 2210Z Effectiveness Factors under 7500, 7510, 7550, 7680 and 8610 posted at: <http://www.caiso.com/Documents/2210Z.pdf>

**J.3.2.8.7.4 Changes compared to the 2027 LCT study**

The load forecast is up by 357 MW and the LCR went up by 240 MW mostly due to load increase.

**J.3.2.9 LA Basin Area****J.3.2.9.1 Area Definition:**

The transmission tie lines into the LA Basin Area are:

San Onofre - San Luis Rey #1, #2, and #3 230 kV Lines

San Onofre - Talega #2 230 kV Lines

San Onofre - Capistrano #1 230 kV Lines

Lugo - Mira Loma #2 & #3 500 kV Lines

Lugo - Rancho Vista #1 500 kV Line

Vincent – Mesa 500 kV Line

Sylmar - Eagle Rock 230 kV Line

Sylmar - Gould 230 kV Line

Vincent - Mesa #1 & #2 230 kV Lines

Vincent - Rio Hondo #1 & #2 230 kV Lines

Devers - Red Bluff 500 kV #1 and #2 Lines

Mirage – Coachella Valley # 1 230 kV Line

Mirage - Ramon # 1 & #2 230 kV Line

Mirage - Julian Hinds 230 kV Line

The substations that delineate the LA Basin Area are:

San Onofre is in San Luis Rey is out

San Onofre is in Talega is out

San Onofre is in Capistrano is out

Mira Loma is in Lugo is out

Rancho Vista is in Lugo is out

Eagle Rock is in Sylmar is out

Gould is in Sylmar is out

Mira Loma is in Vincent is out

Mesa is in Vincent is out

Rio Hondo is in Vincent is out

Devers is in Red Bluff is out

Mirage is in Coachella Valley is out

Mirage is in Ramon is out

Mirage is in Julian Hinds is out

**J.3.2.9.1.1 LA Basin LCR Area Diagram**

Figure J.3.2-73 LA Basin LCR Area

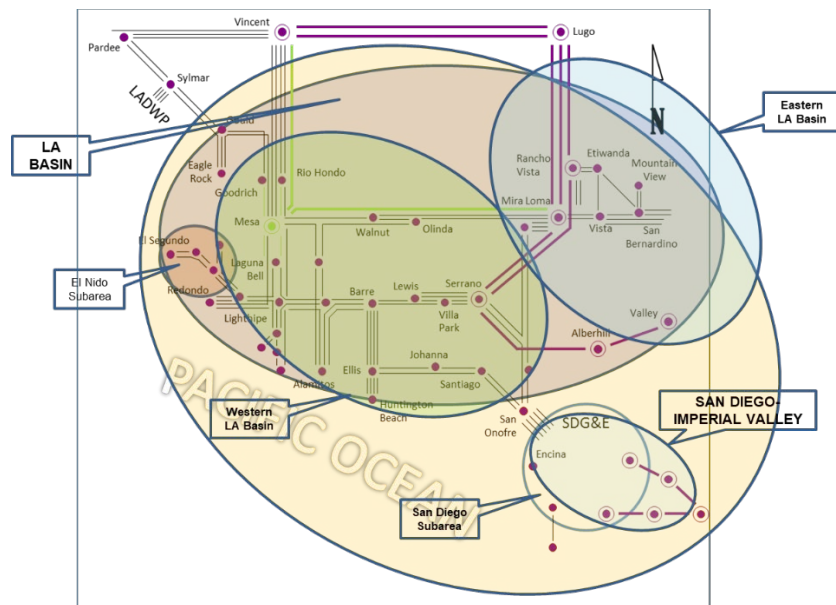

**J.3.2.9.1.2 LA Basin LCR Area Load and Resources**

Table J.3.2-62 provides the forecast load and resources in the LA Basin LCR area in 2032. The list of generators within the LCR area are provided in Attachment A and does not include LTPP Preferred resources or DR.

In year 2032 the estimated time of local area peak is 7:00 PM (PDT) on September 7, 2032.

At the local area peak time the estimated, ISO metered, solar output is 0%.

If required, all non-solar technology type resources are dispatched at NQC.

Table J.3.2-62 LA Basin LCR Area 2032 Forecast Load and Resources

Load (MW)		Generation (MW)	Aug NQC	At Peak
Gross Load (inc. ATE & FS)	21216	Market, Net Seller, Wind	5863	5863
AAEE	-421	Battery	1725	1725
Behind the meter DG	0	MUNI, QF	1080	1080
<b>Net Load</b>	<b>20795</b>	Solar	16	0
Transmission Losses	312	Existing Demand Response	560	560
Pumps	0	LTPP Preferred Resources (BTM BESS, EE, D)	135	135
<b>Load + Losses + Pumps</b>	<b>21107</b>	<b>Total</b>	<b>9379</b>	<b>9363</b>

**J.3.2.9.1.3 Approved transmission projects modeled:**

Mesa Loop-In Project and Laguna Bell Corridor 230 kV line upgrades

Delaney – Colorado River 500 kV Line (Ten West Link Project)

Hassayampa – North Gila #2 500 kV Line (APS)

West of Devers 230 kV line upgrades

Lugo – Victorville 500 kV Upgrade

Alberhill 500 kV Method of Service

Laguna Bell – Mesa No. 1 230 kV Line Rating Increase Project

Retirement of 1,356 MW of the existing Redondo Beach OTC generation

Alamitos repowering (640 MW)

Alamitos Battery Energy Storage System (100 MW)

Retirement of 2,010 MW of the existing Alamitos OTC generation

Huntington Beach repowering (644 MW)

Retirement of 452 MW of the existing Huntington Beach OTC generation

Stanton Energy Reliability Center (98 MW)

### J.3.2.9.2 *El Nido Sub-area*

El Nido is a sub-area of the LA Basin LCR area.

#### J.3.2.9.2.1 **El Nido LCR Sub-area Diagram**

Please refer to Figure 3.2-73 above.

#### J.3.2.9.2.2 **El Nido LCR Sub-area Load and Resources**

Table J.3.2-63 provides the forecast load and resources in El Nido LCR sub-area in 2032. The list of generators within the LCR sub-area are provided in Attachment A.

Table J.3.2-63 El Nido LCR Sub-area 2032 Forecast Load and Resources

Load (MW)		Generation (MW)	Aug NQC	At Peak
Gross Load (inc. ATE & FS)	1261	Market, Net Seller, Wind	549	549
AAEE	-28	Battery	0	0
Behind the meter DG	0	MUNI, QF	0	0
<b>Net Load</b>	<b>1233</b>	Solar	0	0
Transmission Losses	2	Existing Demand Response	12	12
Pumps	0	LTPP Preferred Resources	10	10
<b>Load + Losses + Pumps</b>	<b>1235</b>	<b>Total</b>	<b>571</b>	<b>571</b>

#### J.3.2.9.2.3 **El Nido LCR Sub-area Hourly Profiles**

Figure J.3.2-74 illustrates the forecasted 2032 profile for the peak day for the El Nido LCR sub-area with the Category P7 normal and emergency load serving capabilities without local capacity resources. The chart also includes an estimated amount of energy storage that can be added to this local area from charging restriction perspective and the amount of 4-hour storage that can be added to replace local capacity on a 1 MW for 1 MW basis. Figure J.3.2-75 illustrates the forecasted 2032 hourly profile for El Nido LCR sub-area with the Category P7 normal and emergency load serving capability without local capacity resources.

Figure J.3.2-74 El Nido LCR Sub-area 2032 Peak Day Forecast Profile

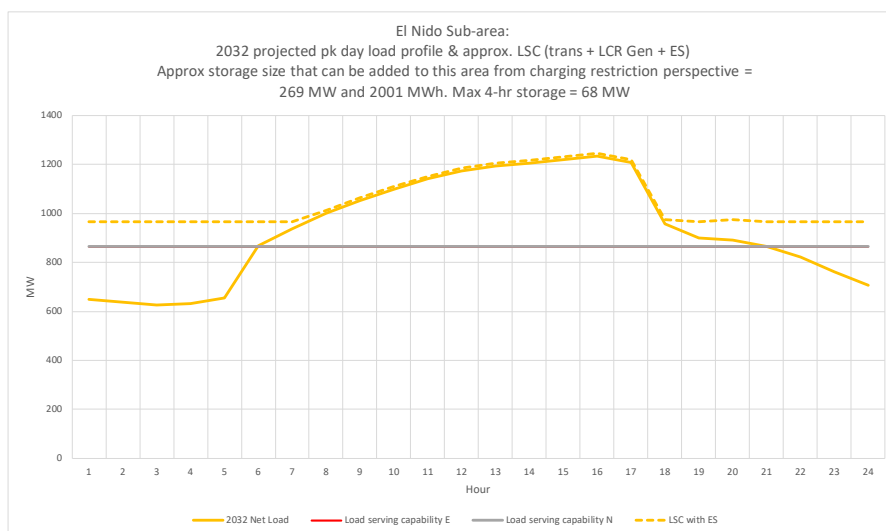
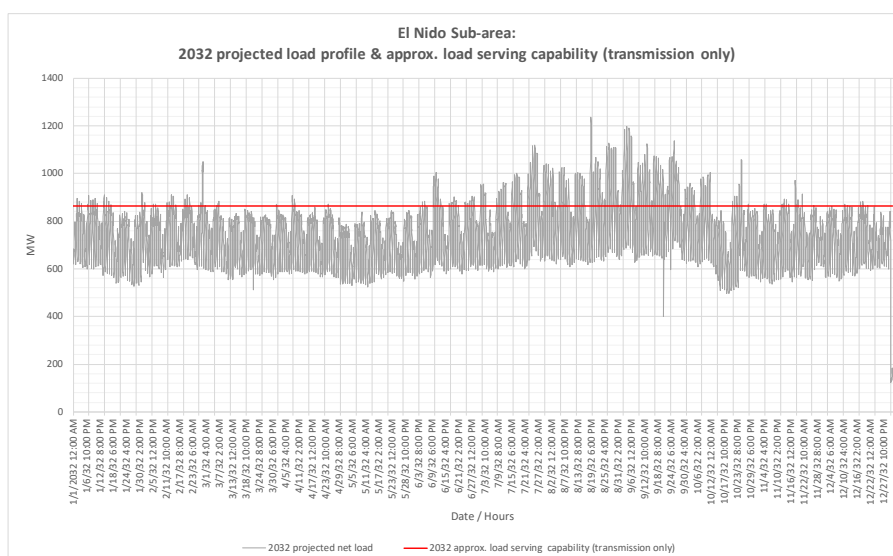

Figure J.3.2-75 El Nido LCR Sub-area 2032 Forecast Hourly Profile



### J.3.2.9.2.4 El Nido LCR Sub-area Requirement

Table J.3.2-64 identifies the sub-area requirements. The LCR requirement for Category P7 contingency is 370 MW.

Table J.3.2-64 El Nido LCR Sub-area Requirements

Year	Limit	Category	Limiting Facility	Contingency	LCR (MW) (Deficiency)
2032	First Limit	P7	La Fresa-La Cienega 230 kV	La Fresa – El Nido #3 & #4 230 kV	370

**J.3.2.9.2.5 Effectiveness factors:**

All units within the El Nido Sub-area have the same effectiveness factor.

For most helpful procurement information please read procedure 2210Z Effectiveness Factors under 7630 posted at: <http://www.caiso.com/Documents/2210Z.pdf>

**J.3.2.9.3 Western LA Basin Sub-area**

Western LA Basin is a sub-area of the LA Basin LCR area.

**J.3.2.9.3.1 Western LA Basin LCR Sub-area Diagram**

Please refer to Figure 3.2-73 above.

**J.3.2.9.3.2 Western LA Basin LCR Sub-area Load and Resources**

Table J.3.2-65 provides the forecast load and resources in Western LA Basin LCR sub-area in 2032. The list of generators within the LCR sub-area are provided in Attachment A.

Table J.3.2-65 Western LA Basin Sub-area 2032 Forecast Load and Resources

Load (MW)		Generation (MW)	Aug NQC	At Peak
Gross Load (inc. ATE &FS)	12749	Market, Net Seller, Wind	3369	3369
AEE	-255	Battery	1177	1177
Behind the meter DG	0	MUNI, QF	589	589
<b>Net Load</b>	<b>12494</b>	Solar	8	0
Transmission Losses	189	Existing Demand Response	355	355
Pumps	0	LTPP Preferred Resources (BTM BESS, EE, DR, PV)	135	135
<b>Load + Losses + Pumps</b>	<b>12683</b>	<b>Total</b>	<b>5633</b>	<b>5625</b>

**J.3.2.9.3.3 Western LA Basin LCR Sub-area Hourly Profiles**

Figure J.3.2-76 illustrates the forecasted 2032 profile for the peak day for the Western LCR sub-area with the Category P6 normal and emergency load serving capabilities without local capacity resources. The chart also includes an estimated amount of energy storage that can be added to this local area from charging restriction perspective and the amount of 4-hour storage that can be added to replace local capacity on a 1 MW for 1 MW basis. Figure J.3.2-77 illustrates the forecasted 2032 hourly profile for Western LCR sub-area with the Category P6 normal and emergency load serving capability without local capacity resources.

Figure J.3.2-76 Western LA Basin LCR Sub-area 2032 Peak Day Forecast Profile

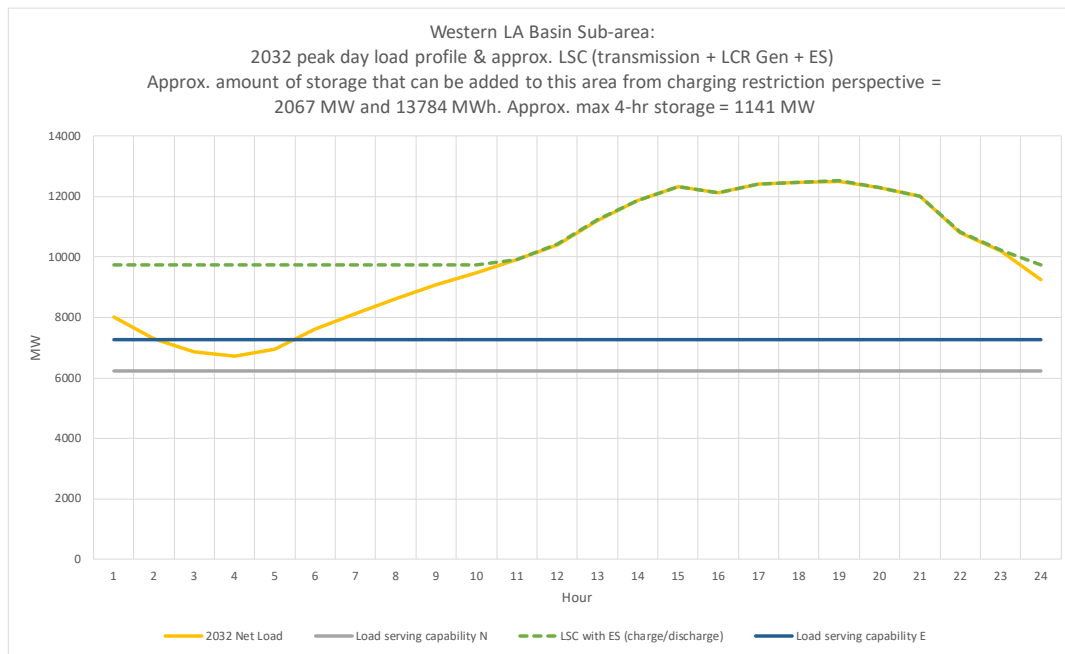
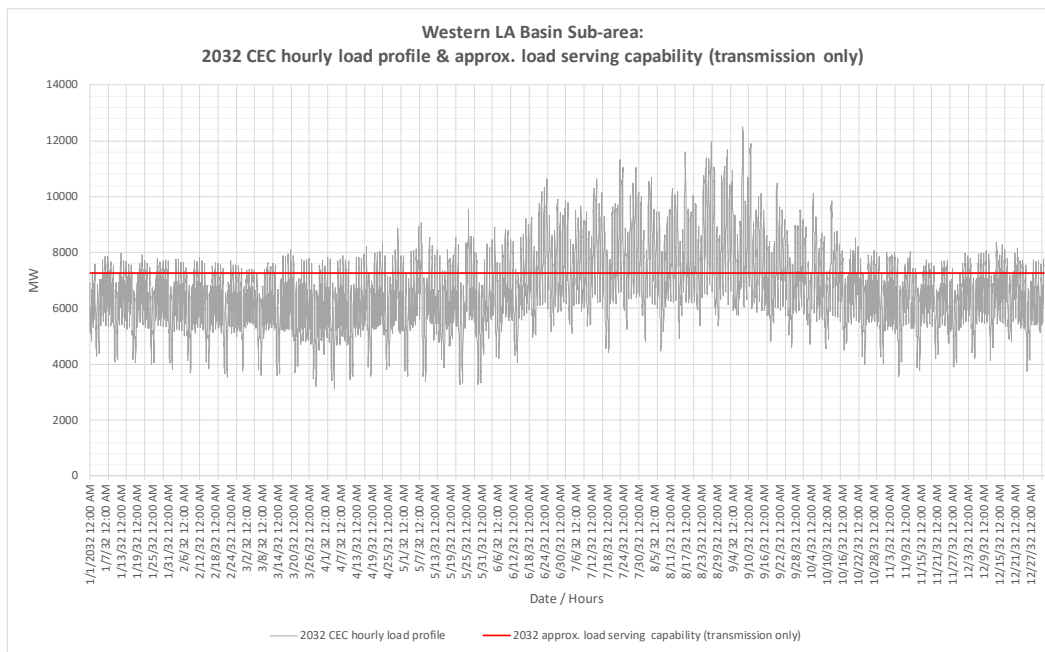

Figure J.3.2-77 Western LA Basin LCR Sub-area 2032 Forecast Hourly Profiles



**J.3.2.9.3.4 Western LA Basin LCR Sub-area Requirement**

Table J.3.2-66 identifies the sub-area LCR requirements. The LCR requirement for Category P6 contingency is 5568 MW. The 2032 LCR need is higher than 2027 LCR need due to higher load forecast for the western LA Basin sub-area.



Table J.3.2-66 Western LA Basin LCR Sub-area Requirements

Year	Limit	Category	Limiting Facility	Contingency	LCR (MW) (Deficiency)
2030	First Limit	P6	Mesa-Laguna Bell 230 kV	Mesa-La Fresa 230 kV, followed by Mesa-Lighthipe 230 kV line or vice versa	5568

**J.3.2.9.3.5 Effectiveness factors:**

See Attachment B - Table titled [LA Basin](#).

For other helpful procurement information please read procedure 2210Z Effectiveness Factors under 7630 posted at: <http://www.caiso.com/Documents/2210Z.pdf>

There are other combinations of contingencies in the area that could overload a significant number of 230 kV lines in this sub-area have less LCR need. As such, anyone of them (combination of contingencies) could become binding for any given set of procured resources. As a result, these effectiveness factors may not be the best indicator towards informed procurement.

**J.3.2.9.4 West of Devers Sub-area**

West of Devers is a sub-area of the LA Basin LCR area.

There are no local capacity requirements due to implementation of the Mesa Loop-in as well as West of Devers reconductoring projects.

**J.3.2.9.5 Valley-Devers Sub-area**

Valley-Devers is a sub-area of the LA Basin LCR area.

There are no local capacity requirements due to implementation of the Colorado River-Delaney 500 kV line project.

**J.3.2.9.6 Valley Sub-area**

Valley is a sub-area of the LA Basin LCR area.

There are no local capacity requirements due to implementation of the Colorado River-Delaney 500 kV line project.

**J.3.2.9.7 Eastern LA Basin Sub-area**

Eastern LA Basin is a sub-area of the LA Basin LCR area.

**J.3.2.9.7.1 Eastern LA Basin LCR Sub-area Diagram**

Please refer to Figure 3.2-73 above.

**J.3.2.9.7.2 Eastern LA Basin LCR Sub-area Load and Resources**

Table J.3.2-67 provides the forecast load and resources in Eastern LA Basin LCR sub-area in 2032. The list of generators within the LCR sub-area are provided in Attachment A.

Table J.3.2-67 Eastern LA Basin Sub-area 2032 Forecast Load and Resources

Load (MW)		Generation (MW)	Aug NQC	At Peak
Gross Load (inc. ATE & FS)	8466	Market, Net Seller, Wind	2494	2494
AAEE	-166	Battery	547	547
Behind the meter DG	0	MUNI, QF	491	491
<b>Net Load</b>	<b>8300</b>	Solar	9	0
Transmission Losses	125	Existing Demand Response	205	205
Pumps	20	LTPP Preferred Resources	0	0
<b>Load + Losses + Pumps</b>	<b>8445</b>	<b>Total</b>	<b>3746</b>	<b>3737</b>

**J.3.2.9.7.3 Eastern LA Basin LCR Sub-area Hourly Profiles**

Figure J.3.2-78 illustrates the forecasted 2032 profile for the peak day for the Eastern LCR sub-area with the Category P1+P7 normal and emergency load serving capabilities without local capacity resources. The chart also includes an estimated amount of energy storage that can be added to this local area from charging restriction perspective and the amount of 4-hour storage that can be added to replace local capacity on a 1 MW for 1 MW basis. Figure J.3.2-79 illustrates the forecasted 2032 hourly profile for Eastern LCR sub-area with the Category P1+P7 normal and emergency load serving capability without local capacity resources.

Figure J.3.2-78 Eastern LA Basin LCR Sub-area 2032 Peak Day Forecast Profile

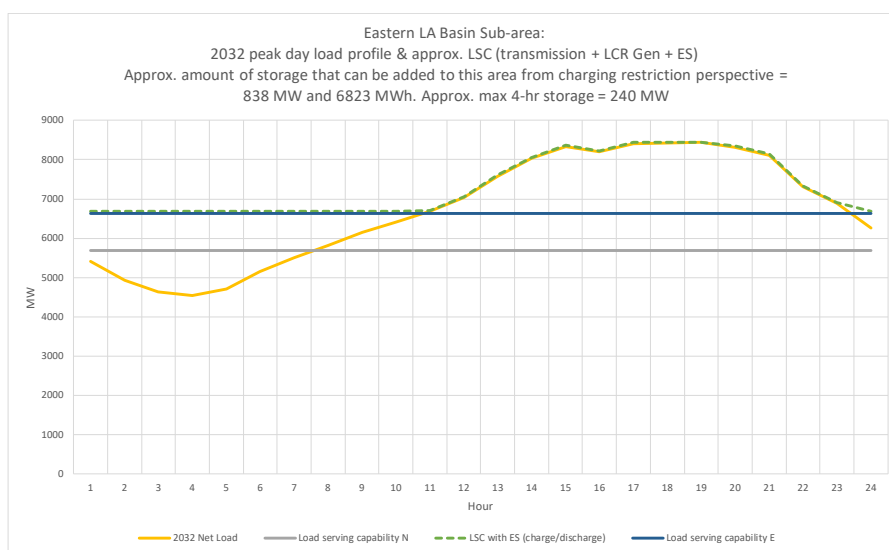
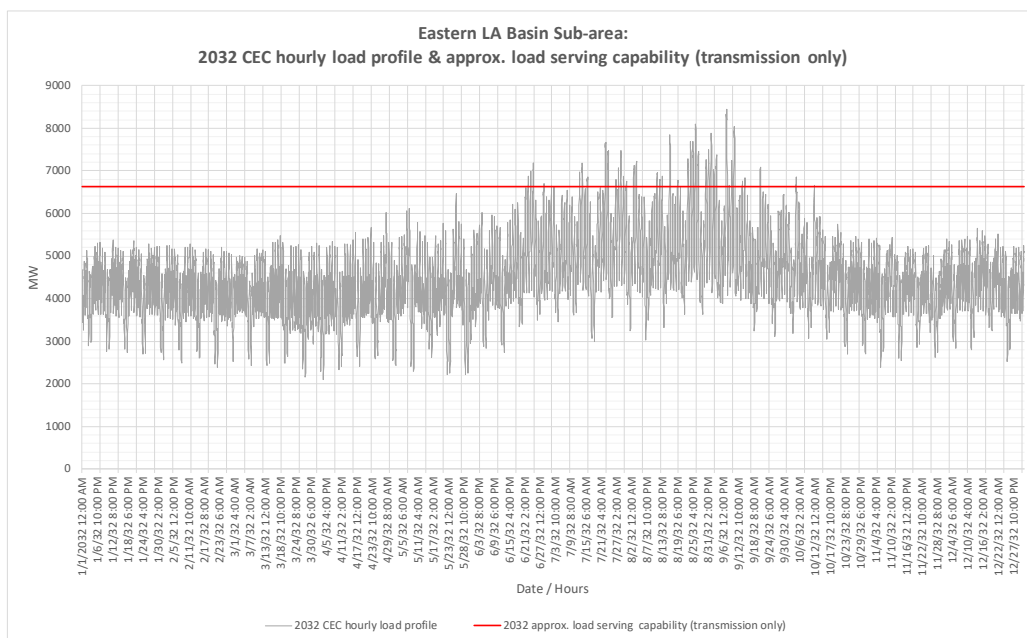

Figure J.3.2-79 Eastern LA Basin LCR Sub-area 2032 Forecast Hourly Profiles



**J.3.2.9.7.4 Eastern LA Basin LCR Sub-area Requirement**

Table J.3.2-68 identifies the sub-area LCR requirements. The LCR requirement for Category P1+P7 contingency is 1820 MW. The 2032 LCR need for the Eastern LA Basin is lower than the 2027 local capacity need due to different critical constraint.

Table J.3.2-68 Eastern LA Basin LCR Sub-area Requirements

Year	Limit	Category	Limiting Facility	Contingency	LCR (MW) (Deficiency)
2032	First Limit	P1+P7	Post transient voltage stability	Lugo-Rancho Vista 500 kV, followed by Lugo-Mira Loma #2 and #3 500 kV	1820

**J.3.2.9.7.5 Effectiveness factors:**

All units within the Eastern LA Basin Sub-area have the same effectiveness factor.

For most helpful procurement information please read procedure 2210Z Effectiveness Factors under 7750 posted at: <http://www.caiso.com/Documents/2210Z.pdf>

**J.3.2.9.8 LA Basin Overall**

**J.3.2.9.8.1 LA Basin LCR Sub-area Hourly Profiles**

Figure J.3.2-80 illustrates the forecasted 2032 profile for the peak day for the LA Basin LCR area with the normal and emergency load serving capabilities without local capacity resources. The chart also includes an estimated amount of energy storage that can be added to this local area from charging restriction perspective and the amount of 4-hour storage that can be added to

replace local capacity on a 1 MW for 1 MW basis. Figure J.3.2-81 illustrates the forecasted 2032 hourly profile for LA Basin LCR area with the normal and emergency load serving capability without local capacity resources.

Figure J.3.2-80 Overall LA Basin LCR Area 2032 Peak Day Forecast Profile

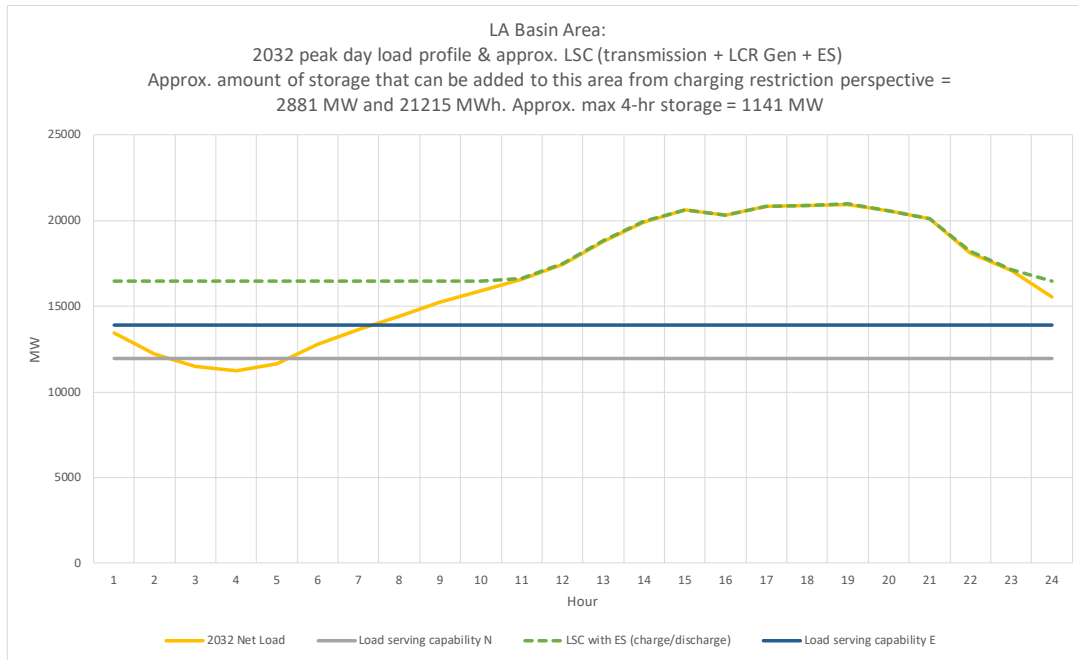
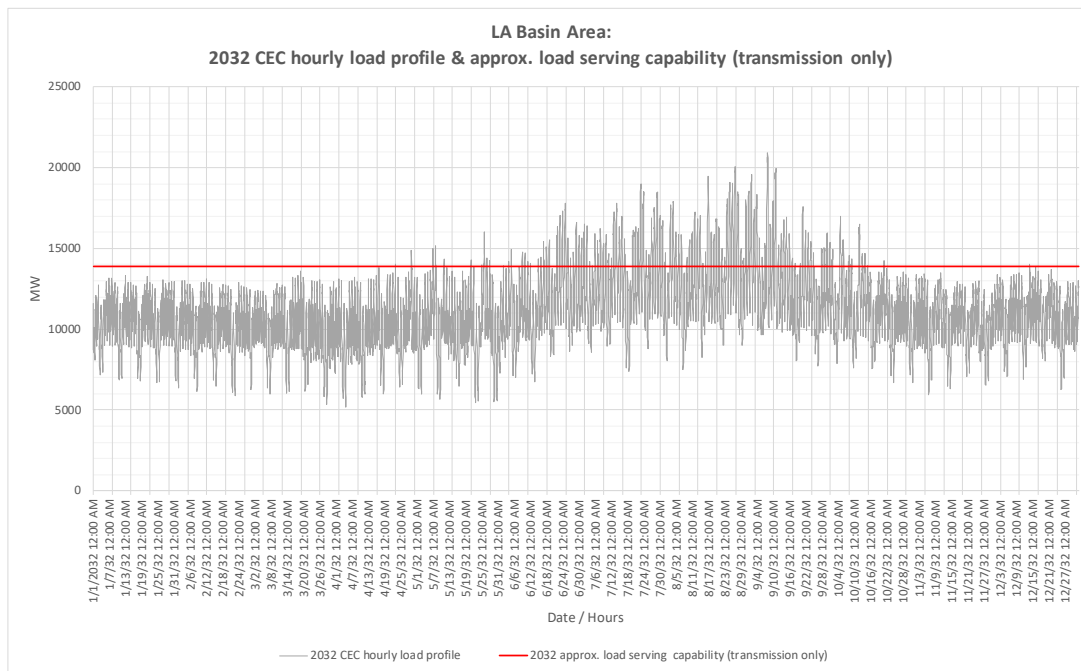

Figure J.3.2-81 Overall LA Basin LCR area 2032 Forecast Hourly Profiles



The following is a summary of estimated amount of storage for the sub-areas and the overall area based on maximum charging capability perspective. Due to non-linearity of power system and the various critical contingencies and load shapes for each sub-area and the overall area, it is noted

that the estimated maximum amount of storage for the sub-areas may not add up to be sum of the overall area. The estimated maximum amount of storage for the LCR area is the amount listed in the last row in the table.

Table J.3.2-69 Estimated LA Basin Sub-areas and Overall Area Energy Storage Capacity and Energy Based on Maximum Charging Capability Perspective

Area/Sub-area	Estimated Energy Storage Maximum Capacity (MW)	Estimated Energy Storage Maximum Energy (MWh)	Estimated Maximum 4-hour Energy Storage
El Nido sub-area	269	2001	68
Western LA Basin sub-area	2067	13784	1141
Eastern LA Basin sub-area	838	6823	240
Overall LA Basin area	2881	21215	1141

#### J.3.2.9.8.2 LA Basin LCR area Requirement

Table J.3.2-70 identifies the area's LCR requirement. The LCR requirement is driven by the sum of the LCR needs for the Western LA Basin and Eastern LA Basin sub-areas, at 7388 MW.

Table J.3.2-70 LA Basin LCR area Requirements

Year	Limit	Category	Limiting Facility	Contingency	LCR (MW) (Deficiency)
2032	First Limit	N/A	Sum of Western and Eastern.		7388

#### J.3.2.9.8.3 Effectiveness factors:

See Attachment B - Table titled [LA Basin](#).

For other helpful procurement information please read procedure 2210Z Effectiveness Factors under 7550, 7570, 7580, 7590, 7590, 7680 and 7750 posted at: <http://www.aiso.com/Documents/2210Z.pdf>

There are other combinations of contingencies in the area that could overload a significant number of 230 kV lines in this sub-area have less LCR need. As such, anyone of them (combination of contingencies) could become binding for any given set of procured resources. As a result, these effectiveness factors may not be the best indicator towards informed procurement.

#### J.3.2.9.8.4 Changes compared to the 2027 LCT study

The load forecast is higher by 1196 MW. The LCR need has increased by 1257 MW primarily due to higher load forecast.

**J.3.2.10 San Diego-Imperial Valley Area****J.3.2.10.1 Area Definition:**

The transmission tie lines forming a boundary around the Greater San Diego-Imperial Valley area include:

- Imperial Valley – North Gila 500 kV Line
- Otay Mesa – Tijuana 230 kV Line
- San Onofre - San Luis Rey #1 230 kV Line
- San Onofre - San Luis Rey #2 230 kV Line
- San Onofre - San Luis Rey #3 230 kV Line
- San Onofre – Talega 230 kV Line
- San Onofre – Capistrano 230 kV Line
- Imperial Valley – El Centro 230 kV Line
- Imperial Valley – La Rosita 230 kV Line

The substations that delineate the Greater San Diego-Imperial Valley area are:

- Imperial Valley is in North Gila is out
- Otay Mesa is in Tijuana is out
- San Onofre is out San Luis Rey is in
- San Onofre is out San Luis Rey is in
- San Onofre is out San Luis Rey is in
- San Onofre is out Talega is in
- San Onofre is out Capistrano is in
- Imperial Valley is in El Centro is out
- Imperial Valley is in La Rosita is out

**J.3.2.10.1.1 San Diego-Imperial Valley LCR Area Diagram**

Figure J.3.2-82 San Diego-Imperial Valley LCR Area

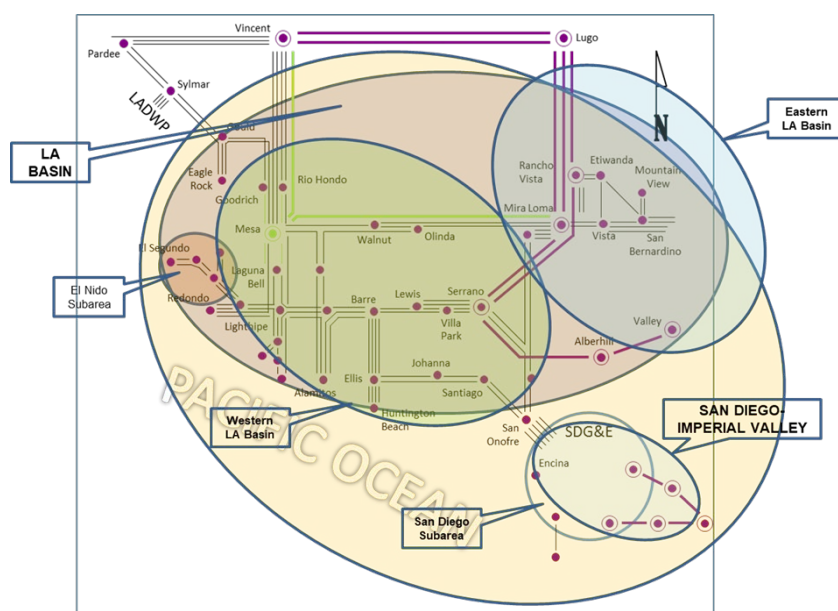

**J.3.2.10.1.2 San Diego-Imperial Valley LCR Area Load and Resources**

Table J.3.2-71 provides the forecast load and resources in the San Diego-Imperial Valley LCR area in 2032. The list of generators within the San Diego-Imperial Valley area are provided in Attachment A.

In year 2032 the estimated time of local area peak is HE 7:00 P.M. (PDT) on September 1, 2032 per the CEC hourly demand forecast.

At the local area peak time the estimated, ISO metered solar output is 0.00%.

If required, all non-solar technology type resources are dispatched at NQC.

Table J.3.2-71 San Diego-Imperial Valley LCR Area 2032 Forecast Load and Resources

Load (MW)		Generation (MW)	Aug NQC	At Peak
Gross Load (inc ATE)	5407	Market, Net Seller, Wind	4308	4308
AAEE	-124	Battery, Hybrid	1601	1601
Behind the meter DG	0	MUNI, QF	2	2
<b>Net Load</b>	<b>5283</b>	Solar	411	0
Transmission Losses	127	Existing Demand Response	26	26
Pumps	0	Mothballed	0	0
<b>Load + Losses + Pumps</b>	<b>5410</b>	<b>Total</b>	<b>6349</b>	<b>5938</b>

**J.3.2.10.1.3 Approved transmission projects modeled:**

Reconductor TL692: Japanese Mesa - Las Pulgas

TL644, South Bay - Sweetwater: Reconductor

TL674A Loop-in (Del Mar - North City West) & Removal of TL666D (Del Mar - Del Mar Tap)

2nd San Marcos–Escondido 69 kV line

Artesian 230 kV expansion with 69 kV upgrade

Rose Canyon - La Jolla 69 kV T/L

Southern Orange County Reliability Enhancement

TL623C Reconductor (San Ysidro - Otay Tap)

TL649D Reconductor (San Ysidro - Otay Lake Tap)

Reconductor TL605 Silvergate – Urban

Re-conductor of Japanese Mesa–Basilone–Talega Tap 69 kV lines

TL632 Granite loop-in and TL6914 reconfiguration

Reconductor of Stuart Tap–Las Pulgas 69 kV line (TL690E)

Open Sweetwater Tap (TL603) and Loop into Sweetwater

Imperial Valley-EI Centro 230 kV (“S”) line upgrade

Also the 500kV line series capacitors on the By-passing 500 kV series capacitor banks on the Southwest Powerlink and Sunrise Powerlink lines are bypassed in the study case.

**J.3.2.10.2 *El Cajon Sub-area***

El Cajon sub-area will be eliminated due to the TL632 Granite loop-in and TL6914 reconfiguration project and change in LCR criteria.

**J.3.2.10.3 *Border Sub-area***

Border is a Sub-area of the San Diego-Imperial Valley LCR Area.



**J.3.2.10.3.1 Border LCR Sub-area Diagram**

Figure J.3.2-83 Border LCR Sub-area

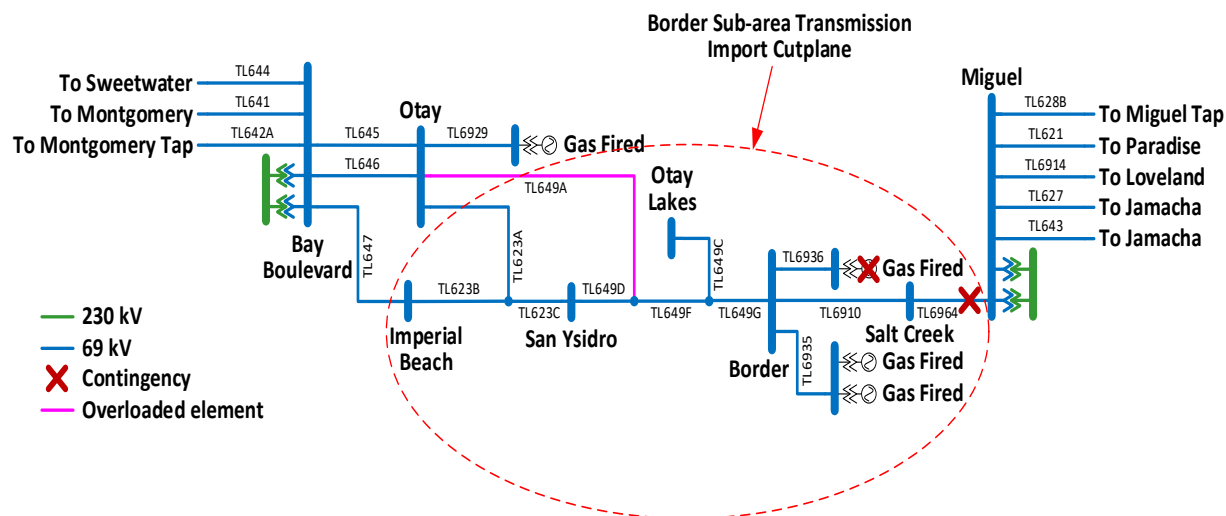

**J.3.2.10.3.2 Border LCR Sub-area Load and Resources**

Table J.3.2-72 provides the forecast load and resources in Border LCR sub-area in 2032. The list of generators within the LCR sub-area are provided in Attachment A.

Table J.3.2-72 Border Sub-area 2032 Forecast Load and Resources

Load (MW)		Generation (MW)	Aug NQC	At Peak
Gross Load	190	Market, Net Seller	145	145
AAEE	-4	Battery	0	0
Behind the meter DG	0	MUNI, QF/Self-gen	0	0
<b>Net Load</b>	<b>186</b>	Solar	0	0
Transmission Losses	1	Demand Response	0	0
Pumps	0	Mothballed	0	0
<b>Load + Losses + Pumps</b>	<b>187</b>	<b>Total</b>	<b>145</b>	<b>145</b>

**J.3.2.10.3.3 Border LCR Sub-area Hourly Profiles**

Figure J.3.2-84 illustrates the forecasted 2032 profile for the peak day for the Border LCR sub-area with the normal and emergency load serving capabilities without local capacity resources. The chart also includes an estimated amount of energy storage that can be added to this local area from charging restriction perspective and the amount of 4-hour storage that can be added to replace local capacity on a 1 MW for 1 MW basis. Figure J.3.2-85 illustrates the forecasted 2032 hourly profile for Border LCR sub-area with the normal and emergency load serving capability without local capacity resources.

Figure J.3.2-84 Border LCR Sub-area 2032 Peak Day Forecast Profiles

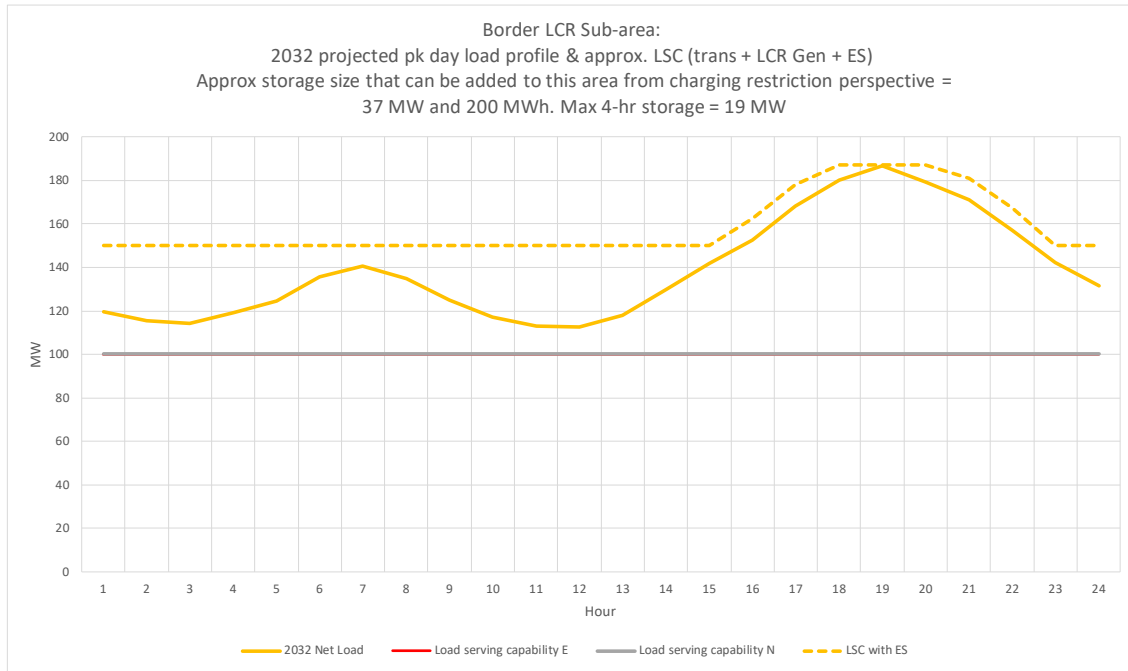
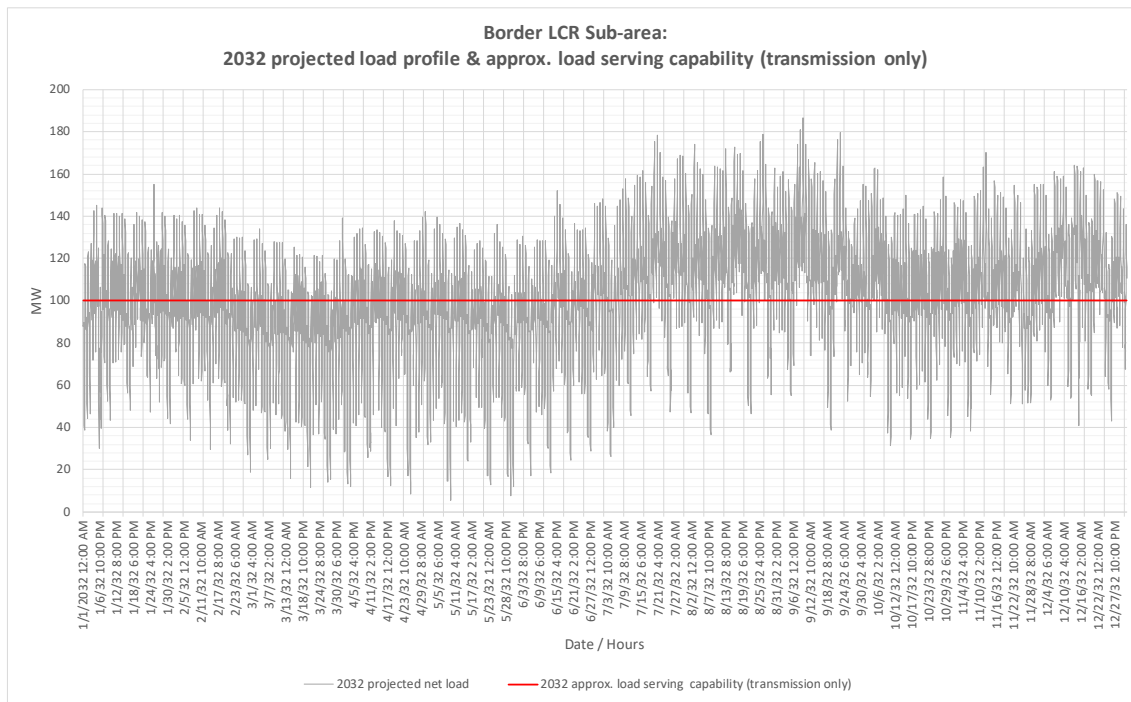

Figure J.3.2-85 Border LCR Sub-area 2032 Forecast Hourly Profiles



**J.3.2.10.3.4 Border LCR Sub-area Requirement**

Table J.3.2-73 identifies the sub-area requirements. The LCR requirement for Category P3 contingency is 109 MW.

Table J.3.2-73 Border 2032 LCR Sub-area Requirements

Year	Category	Limiting Facility	Contingency	LCR (MW) (Deficiency)
2032	P3	Otay – Otay Lakes Tap 69 kV (TL649A)	Border unit out of service followed by the outage of Miguel-Salt Creek 69 kV (TL6964)	109

**J.3.2.10.3.5 Effectiveness factors:**

All units within the Border Sub-area have the same effectiveness factor.

**J.3.2.10.4 San Diego Sub-area**

San Diego is a sub-area of the San Diego-Imperial Valley LCR area.

**J.3.2.10.4.1 San Diego LCR Sub-area Diagram**

Please refer to Figure 3.2-82 above.

**J.3.2.10.4.2 San Diego LCR Sub-area Load and Resources**

Table J.3.2-74 provides the forecast load and resources in San Diego LCR sub-area in 2032. The list of generators within the LCR sub-area are provided in Attachment A.

Table J.3.2-74 San Diego Sub-area 2032 Forecast Load and Resources

Load (MW)		Generation (MW)	Aug NQC	At Peak
Gross Load	5407	Market, Net Seller, Wind	3225	3225
AAEE	-124	Battery, Hybrid	1387	1387
Behind the meter DG	0	MUNI, QF	2	2
<b>Net Load</b>	<b>5283</b>	Solar	15	0
Transmission Losses	127	Existing Demand Response	26	26
Pumps	0	Mothballed	0	0
<b>Load + Losses + Pumps</b>	<b>5410</b>	<b>Total</b>	<b>4655</b>	<b>4640</b>

**J.3.2.10.4.3 San Diego LCR Sub-area Hourly Profiles**

Figure J.3.2-86 illustrates the forecasted 2032 profile for the peak day for the San Diego LCR sub-area with the normal and emergency load serving capabilities without local capacity resources. The chart also includes an estimated amount of energy storage that can be added to this local area from charging restriction perspective and the amount of 4-hour storage that can be added to replace local capacity on a 1 MW for 1 MW basis. Figure J.3.2-87 illustrates the forecasted 2032 hourly profile for San Diego LCR sub-area with the normal and emergency load serving capability without local capacity resources.

Figure J.3.2-86 San Diego LCR Sub-area 2032 Peak Day Forecast Profiles

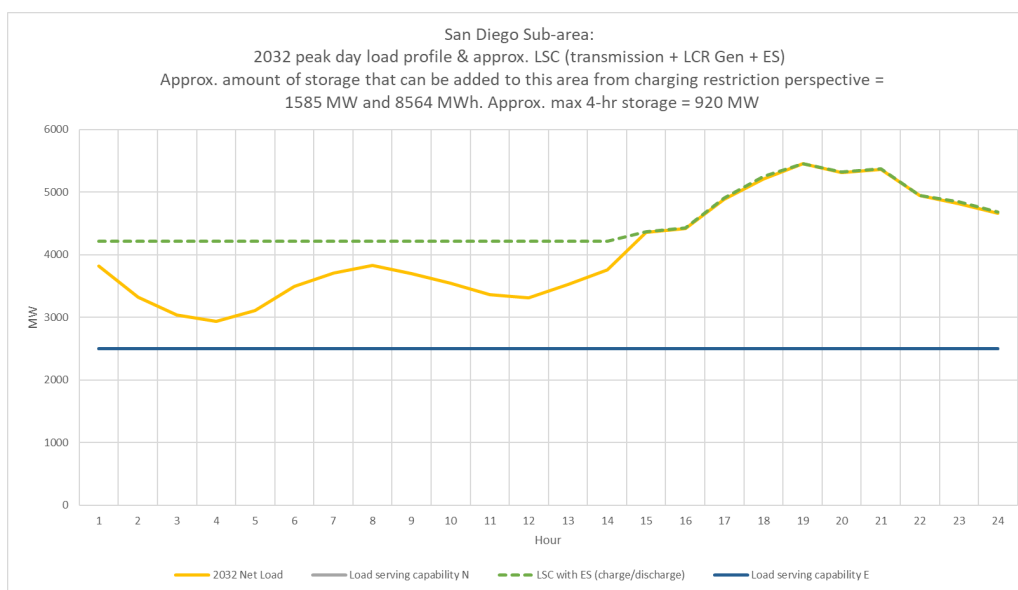
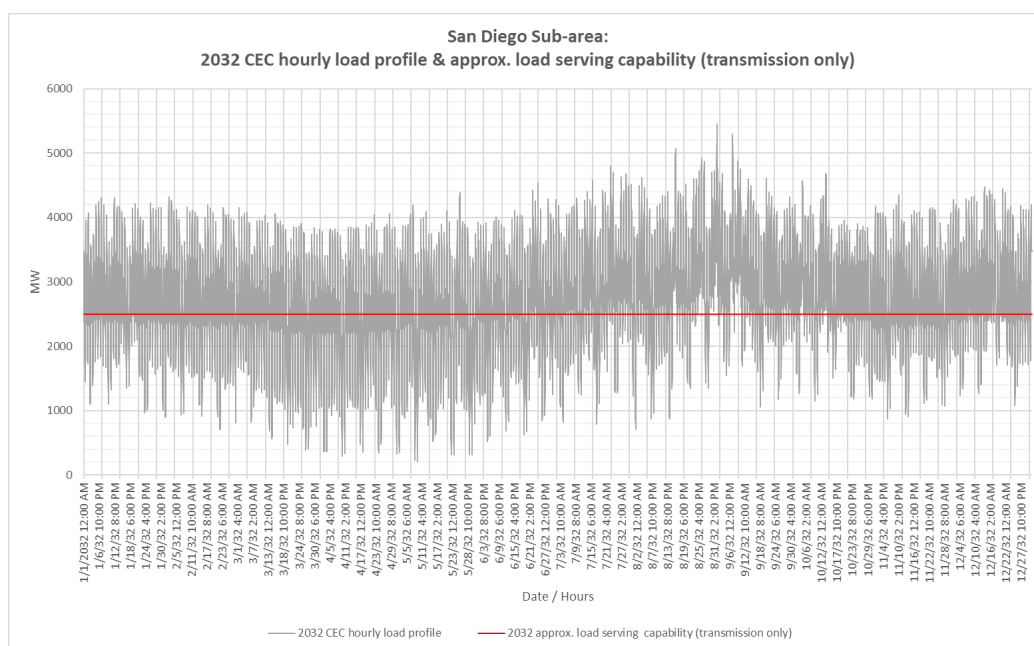

Figure J.3.2-87 San Diego LCR sub-area 2032 Forecast Hourly Profiles



**J.3.2.10.4.4 San Diego LCR Sub-area Requirement**

Table J.3.2-75 identifies the sub-area LCR requirements. The LCR requirement for Category P6 contingency is 2361 MW. The LCR decreases when compared with the 2027 LCR study results due to new resource additions at effective locations.

Table J.3.2-75 San Diego LCR Sub-area Requirements

Year	Limit	Category	Limiting Facility	Contingency	LCR (MW) (Deficiency)
2032	First Limit	P6	Remaining Sycamore – Suncrest 230 kV	Eco – Miguel 500 kV, system readjustment followed by one of the Sycamore – Suncrest 230 kV lines	2361

**J.3.2.10.4.5 Effectiveness factors:**

See Attachment B - Table titled [San Diego](#).

For other helpful procurement information please read procedure 2210Z Effectiveness Factors under 7820 posted at: <http://www.caiso.com/Documents/2210Z.pdf>

**J.3.2.10.5 San Diego-Imperial Valley Overall**

**J.3.2.10.5.1 San Diego-Imperial Valley LCR area Hourly Profiles**

Since the San Diego sub-area has all the substation loads, the overall San Diego-Imperial Valley area has the same load profile as the San Diego bulk sub-area. The Imperial Valley area has generating resources. Figure J.3.2-88 illustrates the forecasted 2032 profile for the peak day for the San Diego-Imperial Valley LCR area with the normal and emergency load serving capabilities without local capacity resources. The chart also includes an estimated amount of energy storage that can be added to this local area from charging restriction perspective and the amount of 4-hour storage that can be added to replace local capacity on a 1 MW for 1 MW basis. Figure J.3.2-89 illustrates the forecasted 2032 hourly profile for San Diego-Imperial Valley LCR area with the normal and emergency load serving capability without local capacity resources.

Figure J.3.2-88 San Diego-Imperial Valley LCR Area 2032 Peak Day Forecast Profile

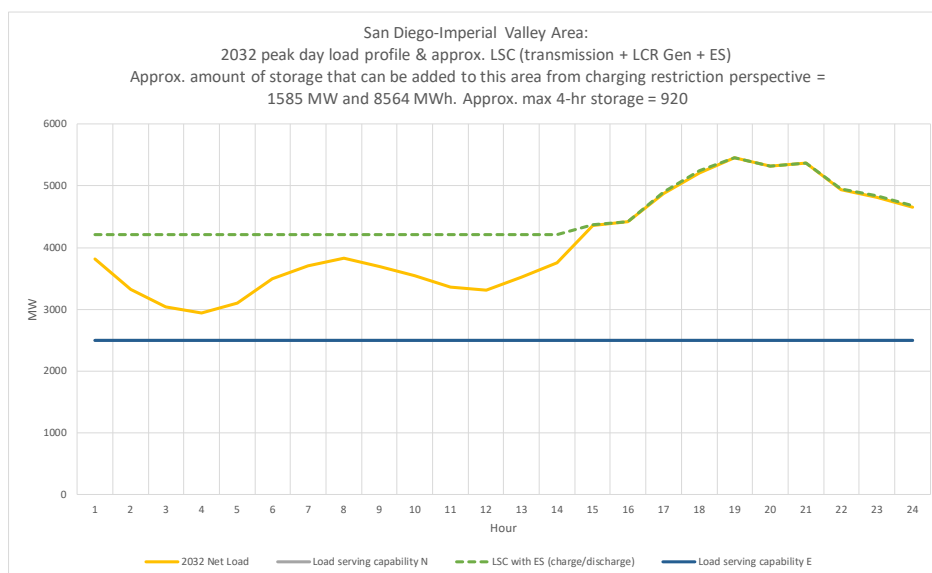
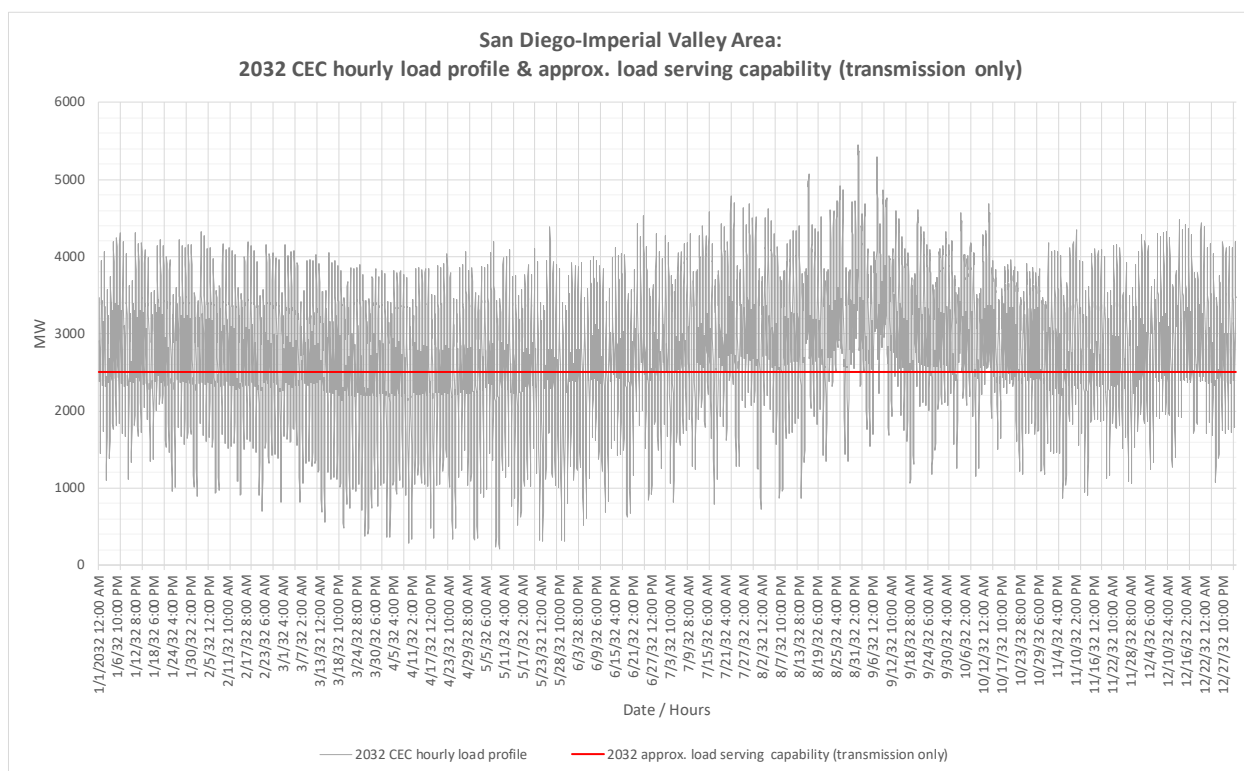

Figure J.3.2-89 San Diego-Imperial Valley Area 2032 Forecast Hourly Profiles



The following is a summary of estimated amount of storage for the sub-areas and the overall area based on maximum charging capability perspective. Due to non-linearity of power system and the various critical contingencies and load shapes for each sub-area and the overall area, it is noted that the estimated maximum amount of storage for the sub-areas many not add up to be sum of the overall area. Since the San Diego sub-area has all the substation loads, the overall San Diego-Imperial Valley area has the same load profile as the San Diego bulk sub-area and therefore same amount of energy storage for the San Diego sub-area. The Imperial Valley area (of the overall San Deigo-Imperial Valley) has generating resources only. The estimated maximum amount of storage for the LCR area is the amount listed in the last row in the table.

Table J.3.2-76 Estimated San Diego Sub-areas and Overall Area Energy Storage Capacity and Energy Based on Maximum Charging Capability Perspective

Area/Sub-area	Estimated Energy Storage Maximum Capacity (MW)	Estimated Energy Storage Maximum Energy (MWh)	Estimated 4-Hour Energy Storage (MW)
Border sub-area	37	200	19
San Diego bulk sub-area	1585	8564	920
Overall San Diego-Imperial Valley area	1585	8564	920

**J.3.2.10.5.2 San Diego-Imperial Valley LCR area Requirement**

Table J.3.2-77 identifies the area LCR requirements. The LCR requirement for Category P3 contingency is 3718 MW.

Table J.3.2-77 San Diego-Imperial Valley LCR area Requirements

Year	Limit	Category	Limiting Facility	Contingency	LCR (MW) (Deficiency)
2032	First Limit	P3	Yucca – Pilot Knob 161 kV line, Yucca 161/69 kV transformer	TDM power plant, system readjustment and Imperial Valley–North Gila 500 kV line	4849

**J.3.2.10.5.3 Effectiveness factors:**

See Attachment B - Table titled [San Diego](#).

For other helpful procurement information please read procedure 2210Z Effectiveness Factors under 7820 posted at: <http://www.caiso.com/Documents/2210Z.pdf>

**J.3.2.10.5.4 Changes compared to the 2027 LCT study**

The demand forecast is higher by 415 MW. The overall LCR need for the San Diego – Imperial Valley area is increased by 1480 MW, due to increase in load forecast and change in critical constraint.

**J.3.2.11 Valley Electric Area**

Valley Electric Association LCR area has been eliminated on the basis of the following:

- No generation exists in this area
- No single-element contingency issues were observed in this area
- Multiple-element contingencies and beyond –
  - No common-mode N-2 issues were observed
  - No issues were observed for category B outage followed by a common-mode N-2 outage
  - All the N-1-1 issues that were observed can either be mitigated by the existing UVLS or by an operating procedure

Attachment A - List of physical resources by PTO, local area and market ID

## Attachment A – List of physical resources by PTO, local area and market ID

PTO	MKT/SCHED RESOURCE ID	BUS #	BUS NAME	kV	NQC	UNIT ID	LCR AREA NAME	LCR SUB-AREA NAME	NQC Comments	CAISO Tag
PG&E	ALMEGT_1_UNIT 1	38118	ALMDACT1	13.8	23.40	1	Bay Area	Oakland		MUNI
PG&E	ALMEGT_1_UNIT 2	38119	ALMDACT2	13.8	23.50	1	Bay Area	Oakland		MUNI
PG&E	BANKPP_2_NSPIN	38820	DELTA A	13.2	11.55	1	Bay Area	Contra Costa	Pumps	MUNI
PG&E	BANKPP_2_NSPIN	38820	DELTA A	13.2	11.55	2	Bay Area	Contra Costa	Pumps	MUNI
PG&E	BANKPP_2_NSPIN	38820	DELTA A	13.2	11.55	3	Bay Area	Contra Costa	Pumps	MUNI
PG&E	BANKPP_2_NSPIN	38815	DELTA B	13.2	11.55	4	Bay Area	Contra Costa	Pumps	MUNI
PG&E	BANKPP_2_NSPIN	38815	DELTA B	13.2	11.55	5	Bay Area	Contra Costa	Pumps	MUNI
PG&E	BANKPP_2_NSPIN	38770	DELTA C	13.2	11.55	6	Bay Area	Contra Costa	Pumps	MUNI
PG&E	BANKPP_2_NSPIN	38770	DELTA C	13.2	11.55	7	Bay Area	Contra Costa	Pumps	MUNI
PG&E	BANKPP_2_NSPIN	38765	DELTA D	13.2	11.55	8	Bay Area	Contra Costa	Pumps	MUNI
PG&E	BANKPP_2_NSPIN	38765	DELTA D	13.2	11.55	9	Bay Area	Contra Costa	Pumps	MUNI
PG&E	BANKPP_2_NSPIN	38760	DELTA E	13.2	11.55	10	Bay Area	Contra Costa	Pumps	MUNI
PG&E	BANKPP_2_NSPIN	38760	DELTA E	13.2	11.55	11	Bay Area	Contra Costa	Pumps	MUNI
PG&E	BLKDIA_2_BDEBT1	365773	Q1111BES	0.69	130.00	1	Bay Area	Pittsburg		Battery
PG&E	BRDSL_2_HIWIND	32172	HIGHWINDS	34.5	34.02	1	Bay Area	Contra Costa	Aug NQC	Wind
PG&E	BRDSL_2_MTZUM2	32179	MONTEZUM	0.69	16.42	1	Bay Area	Contra Costa	Aug NQC	Wind
PG&E	BRDSL_2_MTZUMA	32188	MONTEZUM	0.69	7.73	1	Bay Area	Contra Costa	Aug NQC	Wind
PG&E	BRDSL_2_SHILO1	32181	SHILOH1W	34.5	31.50	1	Bay Area	Contra Costa	Aug NQC	Wind
PG&E	BRDSL_2_SHILO2	365749	SHILOH2W	34.5	31.50	1	Bay Area	Contra Costa	Aug NQC	Wind
PG&E	BRDSL_2_SHLO3A	32191	SHILOH3W	0.58	21.53	1	Bay Area	Contra Costa	Aug NQC	Wind
PG&E	BRDSL_2_SHLO3B	32194	SHILOH4W	0.58	21.00	1	Bay Area	Contra Costa	Aug NQC	Wind
PG&E	CALPIN_1_AGNEW	35860	AGNEWCOG	13.8	21.71	1	Bay Area	San Jose, South Bay-Moss Landing	Aug NQC	Market
PG&E	CALPIN_1_AGNEW	35860	AGNEWCOG	13.8	6.85	2	Bay Area	San Jose, South Bay-Moss Landing	Aug NQC	Market
PG&E	CAYTNO_2_VASCO				4.30		Bay Area	Contra Costa	Aug NQC	Market
PG&E	CLRMTK_1_QF				0.00		Bay Area	Oakland	Not modeled	QF/Selfgen



Attachment A - List of physical resources by PTO, local area and market ID

PG&E	COCOPP_2_CTG1	33188	MARSHCT1	16.4	192.96	1	Bay Area	Contra Costa	Aug NQC	Market
PG&E	COCOPP_2_CTG2	33188	MARSHCT2	16.4	192.19	2	Bay Area	Contra Costa	Aug NQC	Market
PG&E	COCOPP_2_CTG3	33189	MARSHCT3	16.4	191.43	3	Bay Area	Contra Costa	Aug NQC	Market
PG&E	COCOPP_2_CTG4	33189	MARSHCT4	16.4	192.77	4	Bay Area	Contra Costa	Aug NQC	Market
PG&E	COCOSB_6_SOLAR				0.00		Bay Area	Contra Costa	Not modeled Energy Only	Solar
PG&E	CROKET_7_UNIT	32900	CRCKTCOG	18	216.78	1	Bay Area	Pittsburg	Aug NQC	QF/Selfgen
PG&E	CSCCOG_1_UNIT 1				6.00		Bay Area	San Jose, South Bay-Moss Landing		MUNI
PG&E	CSCGNR_1_UNIT 1	36858	Gia100	13.8	24.00	1	Bay Area	San Jose, South Bay-Moss Landing		MUNI
PG&E	CSCGNR_1_UNIT 2	36895	Gia200	13.8	24.00	2	Bay Area	San Jose, South Bay-Moss Landing		MUNI
PG&E	CUMBIA_1_SOLAR	33102	COLUMBIA	0.38	5.13	1	Bay Area	Pittsburg	Aug NQC	Solar
PG&E	DELTA_2_PL1X4	33107	DEC STG1	24	276.23	1	Bay Area	Pittsburg	Aug NQC	Market
PG&E	DELTA_2_PL1X4	33108	DEC CTG1	18	185.59	1	Bay Area	Pittsburg	Aug NQC	Market
PG&E	DELTA_2_PL1X4	33109	DEC CTG2	18	185.59	1	Bay Area	Pittsburg	Aug NQC	Market
PG&E	DELTA_2_PL1X4	33110	DEC CTG3	18	185.59	1	Bay Area	Pittsburg	Aug NQC	Market
PG&E	DIXNLD_1_LNDFL				0.97		Bay Area		Not modeled Aug NQC	Market
PG&E	DUANE_1_PL1X3	36863	DVRaGT1	13.8	48.27	1	Bay Area	San Jose, South Bay-Moss Landing		MUNI
PG&E	DUANE_1_PL1X3	36864	DVRbGT2	13.8	48.27	1	Bay Area	San Jose, South Bay-Moss Landing		MUNI
PG&E	DUANE_1_PL1X3	36865	DVRaST3	13.8	46.96	1	Bay Area	San Jose, South Bay-Moss Landing		MUNI
PG&E	GATWAY_2_PL1X3	33118	GATEWAY1	18	174.69	1	Bay Area	Contra Costa	Aug NQC	Market
PG&E	GATWAY_2_PL1X3	33119	GATEWAY2	18	165.41	1	Bay Area	Contra Costa	Aug NQC	Market
PG&E	GATWAY_2_PL1X3	33120	GATEWAY3	18	165.41	1	Bay Area	Contra Costa	Aug NQC	Market
PG&E	GILROY_1_UNIT	35850	GILROYEN	13.8	75.57	1	Bay Area	Llagas, San Jose, South Bay-Moss Landing	Aug NQC	Market
PG&E	GILROY_1_UNIT	35871	GILROYEN	13.8	39.43	2	Bay Area	Llagas, San Jose, South Bay-Moss Landing	Aug NQC	Market
PG&E	GILRPP_1_PL1X2	35851	GROYPKR1	13.8	47.60	1	Bay Area	Llagas, San Jose, South Bay-Moss Landing	Aug NQC	Market

Attachment A - List of physical resources by PTO, local area and market ID

PG&E	GILRPP_1_PL1X2	35852	GROYPKR2	13.8	47.60	1	Bay Area	Llagas, San Jose, South Bay-Moss Landing	Aug NQC	Market
PG&E	GILRPP_1_PL3X4	35853	GROYPKR3	13.8	46.20	1	Bay Area	Llagas, San Jose, South Bay-Moss Landing	Aug NQC	Market
PG&E	GRZZLY_1_BERKLY	32741	HILLSIDE	12.5	0.61	1	Bay Area		Aug NQC	Net Seller
PG&E	KELSO_2_UNITS	33813	MARIPCT1	13.8	47.86	1	Bay Area	Contra Costa	Aug NQC	Market
PG&E	KELSO_2_UNITS	33815	MARIPCT2	13.8	47.86	2	Bay Area	Contra Costa	Aug NQC	Market
PG&E	KELSO_2_UNITS	33817	MARIPCT3	13.8	47.86	3	Bay Area	Contra Costa	Aug NQC	Market
PG&E	KELSO_2_UNITS	33819	MARIPCT4	13.8	47.86	4	Bay Area	Contra Costa	Aug NQC	Market
PG&E	KIRKER_7_KELCYN				3.37		Bay Area	Pittsburg	Not modeled	Market
PG&E	LAWRNC_7_SUNYVL				0.02		Bay Area		Not modeled Aug NQC	Market
PG&E	LECEF_1_UNITS	35858	LECEFST1	13.8	113.06	1	Bay Area	San Jose, South Bay-Moss Landing		Market
PG&E	LECEF_1_UNITS	35854	LECEFGT1	13.8	47.11	1	Bay Area	San Jose, South Bay-Moss Landing	Aug NQC	Market
PG&E	LECEF_1_UNITS	35855	LECEFGT2	13.8	47.11	1	Bay Area	San Jose, South Bay-Moss Landing	Aug NQC	Market
PG&E	LECEF_1_UNITS	35856	LECEFGT3	13.8	47.11	1	Bay Area	San Jose, South Bay-Moss Landing	Aug NQC	Market
PG&E	LECEF_1_UNITS	35857	LECEFGT4	13.8	47.11	1	Bay Area	San Jose, South Bay-Moss Landing	Aug NQC	Market
PG&E	LMBEPK_2_UNITA1	32173	LAMBIE	13.8	47.50	1	Bay Area	Contra Costa	Aug NQC	Market
PG&E	LMBEPK_2_UNITA2	32174	GOOSEHAV	13.8	47.60	3	Bay Area	Contra Costa	Aug NQC	Market
PG&E	LMBEPK_2_UNITA3	32175	CREED	13.8	47.40	2	Bay Area	Contra Costa	Aug NQC	Market
PG&E	LMEC_1_PL1X3	33113	LMECST1	18	243.71	1	Bay Area	Pittsburg	Aug NQC	Market
PG&E	LMEC_1_PL1X3	33111	LMECCT2	18	165.41	1	Bay Area	Pittsburg	Aug NQC	Market
PG&E	LMEC_1_PL1X3	33112	LMECCT1	18	165.41	1	Bay Area	Pittsburg	Aug NQC	Market
PG&E	MARTIN_1_SUNSET				1.22		Bay Area		Not modeled Aug NQC	QF/Selfgen
PG&E	METEC_2_PL1X3	35883	MEC STG1	18	221.79	1	Bay Area	South Bay-Moss Landing	Aug NQC	Market
PG&E	METEC_2_PL1X3	35881	MEC CTG1	18	185.68	1	Bay Area	South Bay-Moss Landing	Aug NQC	Market
PG&E	METEC_2_PL1X3	35882	MEC CTG2	18	185.68	1	Bay Area	South Bay-Moss Landing	Aug NQC	Market

Attachment A - List of physical resources by PTO, local area and market ID

PG&E	MISSIX_1_QF	33250	MISSON_D	12.5	0.01	1	Bay Area	Ames	Aug NQC	QF/Selfgen
PG&E	MLPTAS_7_QFUNTS				0.00		Bay Area	San Jose, South Bay-Moss Landing	Not modeled Aug NQC	QF/Selfgen
PG&E	MOSSLD_1_QF				0.01		Bay Area		Not modeled Aug NQC	Market
PG&E	MOSSLD_2_PSP1	36223	DUKMOSS3	18	183.60	1	Bay Area	South Bay-Moss Landing		Market
PG&E	MOSSLD_2_PSP1	36221	DUKMOSS1	18	163.20	1	Bay Area	South Bay-Moss Landing		Market
PG&E	MOSSLD_2_PSP1	36222	DUKMOSS2	18	163.20	1	Bay Area	South Bay-Moss Landing		Market
PG&E	MOSSLD_2_PSP2	36226	DUKMOSS6	18	183.60	1	Bay Area	South Bay-Moss Landing		Market
PG&E	MOSSLD_2_PSP2	36224	DUKMOSS4	18	163.20	1	Bay Area	South Bay-Moss Landing		Market
PG&E	MOSSLD_2_PSP2	36225	DUKMOSS5	18	163.20	1	Bay Area	South Bay-Moss Landing		Market
PG&E	NEWARK_1_QF				0.03		Bay Area		Not modeled Aug NQC	QF/Selfgen
PG&E	OAK C_1_EBMUD				1.72		Bay Area	Oakland	Not modeled Aug NQC	MUNI
PG&E	OAK C_7_UNIT 1	32901	OAKLND 1	13.8	0.00	1	Bay Area	Oakland	Could retire by 2023	Market
PG&E	OAK C_7_UNIT 3	32903	OAKLND 3	13.8	0.00	1	Bay Area	Oakland	Could retire by 2023	Market
PG&E	OAK L_1_GTG1				0.00		Bay Area	Oakland	Not modeled Energy Only	Market
PG&E	OXMTN_6_LNDFIL	33469	OX_MTN	4.16	1.50	1	Bay Area	Ames		Market
PG&E	OXMTN_6_LNDFIL	33469	OX_MTN	4.16	1.50	2	Bay Area	Ames		Market
PG&E	OXMTN_6_LNDFIL	33469	OX_MTN	4.16	1.50	3	Bay Area	Ames		Market
PG&E	OXMTN_6_LNDFIL	33469	OX_MTN	4.16	1.50	4	Bay Area	Ames		Market
PG&E	OXMTN_6_LNDFIL	33469	OX_MTN	4.16	1.50	5	Bay Area	Ames		Market
PG&E	OXMTN_6_LNDFIL	33469	OX_MTN	4.16	1.50	6	Bay Area	Ames		Market
PG&E	OXMTN_6_LNDFIL	33469	OX_MTN	4.16	1.50	7	Bay Area	Ames		Market
PG&E	PALALT_7_COBUG				4.50		Bay Area		Not modeled	MUNI
PG&E	RICHMN_1_CHVSR2				2.30		Bay Area		Not modeled Aug NQC	Solar
PG&E	RICHMN_1_SOLAR				0.54		Bay Area		Not modeled Aug NQC	Solar

Attachment A - List of physical resources by PTO, local area and market ID

PG&E	RICHMN_7_BAYENV				0.23		Bay Area		Not modeled Aug NQC	Market
PG&E	RUSCTY_2_UNITS	35306	RUSELST1	15	237.09	3	Bay Area	Ames	No NQC - Pmax	Market
PG&E	RUSCTY_2_UNITS	35304	RUSELCT1	15	180.15	1	Bay Area	Ames	No NQC - Pmax	Market
PG&E	RUSCTY_2_UNITS	35305	RUSELCT2	15	180.15	2	Bay Area	Ames	No NQC - Pmax	Market
PG&E	RVRVEW_1_UNITA1	33178	RVEC_GEN	13.8	47.60	1	Bay Area	Contra Costa	Aug NQC	Market
PG&E	SHELRF_1_UNITS	33142	SHELL 2	12.5	0.04	1	Bay Area	Pittsburg	Aug NQC	Net Seller
PG&E	SHELRF_1_UNITS	33143	SHELL 3	12.5	0.04	1	Bay Area	Pittsburg	Aug NQC	Net Seller
PG&E	SHELRF_1_UNITS	33141	SHELL 1	12.5	0.02	1	Bay Area	Pittsburg	Aug NQC	Net Seller
PG&E	SRINTL_6_UNIT	33468	SRI INTL	9.11	0.81	1	Bay Area		Aug NQC	QF/Selfgen
PG&E	STOILS_1_UNITS	32921	CHEVGEN1	13.8	0.00	1	Bay Area	Pittsburg	Aug NQC	Market
PG&E	STOILS_1_UNITS	32922	CHEVGEN2	13.8	0.00	1	Bay Area	Pittsburg	Aug NQC	Market
PG&E	STOILS_1_UNITS	32923	CHEVGEN3	13.8	0.00	3	Bay Area	Pittsburg	Aug NQC	Market
PG&E	TIDWTR_2_UNITS	33151	FOSTER W	12.5	10.39	1	Bay Area	Pittsburg	Aug NQC	Net Seller
PG&E	TIDWTR_2_UNITS	33151	FOSTER W	12.5	10.39	2	Bay Area	Pittsburg	Aug NQC	Net Seller
PG&E	TIDWTR_2_UNITS	33151	FOSTER W	12.5	7.91	3	Bay Area	Pittsburg	Aug NQC	Net Seller
PG&E	UNCHEM_1_UNIT	32920	UNION CH	9.11	13.64	1	Bay Area	Pittsburg	Aug NQC	QF/Selfgen
PG&E	UNOCAL_1_UNITS	32910	UNOCAL	12	0.21	1	Bay Area	Pittsburg	Aug NQC	QF/Selfgen
PG&E	UNOCAL_1_UNITS	32910	UNOCAL	12	0.21	2	Bay Area	Pittsburg	Aug NQC	QF/Selfgen
PG&E	UNOCAL_1_UNITS	32910	UNOCAL	12	0.21	3	Bay Area	Pittsburg	Aug NQC	QF/Selfgen
PG&E	USWNRD_2_LABWD1	365729	LABRISAW	0.57	1.89	1	Bay Area	Contra Costa	Aug NQC	Wind
PG&E	USWNRD_2_SMUD	365574	SOLANO2W	1	18.24	2	Bay Area	Contra Costa	Aug NQC	Wind
PG&E	USWNRD_2_SMUD	365566	SOLANO1W	0.69	3.22	1	Bay Area	Contra Costa	Aug NQC	Wind
PG&E	USWNRD_2_SMUD2	365600	SOLANO3W	1	26.84	3	Bay Area	Contra Costa	Aug NQC	Wind
PG&E	USWPFK_6_FRICK	365608	FRICKWIN	12	2.10	1	Bay Area	Contra Costa	Aug NQC	Wind
PG&E	USWPJR_2_UNITS	39233	GRNRDG	0.69	16.42	1	Bay Area	Contra Costa	Aug NQC	Wind
PG&E	VISTRA_5_DALBT1	366711	Q1472BES	34.5	100.00	1	Bay Area	South Bay-Moss Landing		Battery
PG&E	VISTRA_5_DALBT2	366712	Q1472BES	34.5	100.00	2	Bay Area	South Bay-Moss Landing		Battery
PG&E	VISTRA_5_DALBT3	366713	Q1472BES	34.5	100.00	3	Bay Area	South Bay-Moss Landing		Battery
PG&E	VISTRA_5_DALBT4	366715	Q1472BES	34.5	100.00	4	Bay Area	South Bay-Moss Landing		Battery

Attachment A - List of physical resources by PTO, local area and market ID

PG&E	WNDMAS_2_UNIT 1	33170	WINDMSTR	21.6	7.98	1	Bay Area	Contra Costa	Aug NQC	Wind
PG&E	ZOND_6_UNIT				3.59		Bay Area	Contra Costa	Not modeled Aug NQC	Wind
PG&E	ZZ_IMHOFF_1_UNIT 1	33136	CCCSD	12.5	0.00	1	Bay Area	Pittsburg	No NQC - hist. data	QF/Selfgen
PG&E	ZZ_MARKHM_1_CATLST	35863	CATALYST	9.11	0.00	1	Bay Area	San Jose, South Bay-Moss Landing		QF/Selfgen
PG&E	ZZ_NA	35861	SJ-SCL W	4.3	0.00	1	Bay Area	San Jose, South Bay-Moss Landing	No NQC - hist. data	QF/Selfgen
PG&E	ZZ_NA	36209	SLD ENRG	12.5	0.00	1	Bay Area	South Bay-Moss Landing		QF/Selfgen
PG&E	ZZ_ZANKER_1_UNIT 1	35861	SJ-SCL W	4.3	0.00	RN	Bay Area	San Jose, South Bay-Moss Landing	No NQC - hist. data	QF/Selfgen
PG&E	ZZZ_New Unit	366394	Q1454B	0.69	75.00	1	Bay Area	San Jose, South Bay-Moss Landing	E-4949	Battery
PG&E	ZZZ_New Unit	365773	Q1111BES	0.69	70.00	1	Bay Area	Pittsburg	No NQC - Pmax	Battery
PG&E	ZZZ_New Unit	366107	Q1374BES	0.55	62.50	1	Bay Area	South Bay-Moss Landing	E-4949	Battery
PG&E	ZZZ_New Unit	366108	Q1374BES	0.55	60.00	2	Bay Area	South Bay-Moss Landing	E-4949	Battery
PG&E	ZZZ_New Unit	366109	Q1374BES	0.55	60.00	3	Bay Area	South Bay-Moss Landing	E-4949	Battery
PG&E	ZZZ_New Unit	365609	OAKLANDES2	13.8	55.00	2	Bay Area	Oakland		Battery
PG&E	ZZZ_New Unit	35884	LLAGAS_D	21.6	20.00	1	Bay Area	Llagas, San Jose, South Bay-Moss Landing		Battery
PG&E	ZZZ_New Unit	365540	Q1016	12.5	0.00	1	Bay Area		Energy Only	Market
PG&E	ZZZ_New Unit	32741	HILLSIDE	12.5	0.00	2	Bay Area		Energy Only	Market
PG&E	ZZZ_New Unit	33103	TASSAJAR	21.6	0.00	RE	Bay Area	Pittsburg	Energy Only	Solar
PG&E	ZZZ_New Unit	36232	CAMPEVER	21.6	0.00	RE	Bay Area	South Bay-Moss Landing	Energy Only	Solar
PG&E	ZZZ_New Unit	33450	FACEBOOK	12	0.00	RE	Bay Area	Ames	Energy Only	Solar
PG&E	ZZZ_New Unit	32741	HILLSIDE	12.5	0.00	RN	Bay Area		Energy Only	Market
PG&E	ZZZ_New Unit	365559	STANFORD	12.5	0.00	RN	Bay Area		Energy Only	Market
PG&E	ZZZ_New Unit	35302	NUMMI-LV	12.6	0.00	RN	Bay Area		Energy Only	Market
PG&E	ZZZ_New Unit	35859	HGST-LV	12.4	0.00	RN	Bay Area		Energy Only	Market
PG&E	ZZZ_New Unit	35307	A100US-L	12.6	0.00	RN	Bay Area		Energy Only	Market

Attachment A - List of physical resources by PTO, local area and market ID

PG&E	ZZZZA_New Unit	33208	MARTIN C	115	90.00	2	Bay Area		No NQC - est. data	Battery
PG&E	ZZZZA_New Unit	35658	LS ESTRS	115	90.00	3	Bay Area	San Jose, South Bay-Moss Landing	No NQC - est. data	Battery
PG&E	ZZZZA_New Unit	30526	BDLSWSTA	230	25.39	1	Bay Area	Contra Costa	No NQC - est. data	Wind
PG&E	ZZZZA_New Unit	30569	KELSO	230	11.00	1	Bay Area	Contra Costa	No NQC - est. data	Wind
PG&E	ZZZZA_New Unit	35658	LS ESTRS	115	5.00	1	Bay Area	San Jose, South Bay-Moss Landing	No NQC - est. data	Market
PG&E	ZZZZA_New Unit	30735	METCALF	230	4.34	2	Bay Area	South Bay-Moss Landing	No NQC - est. data	Solar
PG&E	ZZZZA_New Unit	30735	METCALF	230	4.00	1	Bay Area	South Bay-Moss Landing	No NQC - est. data	Market
PG&E	ZZZZA_New Unit	33208	MARTIN C	115	2.36	1	Bay Area		No NQC - est. data	Solar
PG&E	ZZZZA_New Unit	35658	LS ESTRS	115	1.24	2	Bay Area	San Jose, South Bay-Moss Landing	No NQC - est. data	Solar
PG&E	ZZZZA_New Unit	30526	PITSB D	230	0.00	1	Bay Area	Pittsburg	No NQC - est. data	Battery
PG&E	ZZZZA_New Unit	30045	MOSLAND	500	0.00	1	Bay Area	South Bay-Moss Landing	No NQC - est. data	Battery
PG&E	ZZZZA_New Unit	30735	METCALF	230	0.00	3	Bay Area	South Bay-Moss Landing	No NQC - est. data	Battery
PG&E	ZZZZZ_STAUFF_1_UNIT	33139	STAUFER	9.11	0.00	1	Bay Area		Retired	QF/Selfgen
PG&E	ADERA_1_SOLAR1	34319	CHWCHLAS	0.48	0.00	1	Fresno	Herndon, Panoche 115 kV, Wilson 115 kV	Energy Only	Solar
PG&E	ADMEST_6_SOLAR	34315	ADAMS_E	12.5	0.00	1	Fresno	Herndon	Energy Only	Solar
PG&E	AGRICO_6_PL3N5	34608	AGRICO	13.8	22.69	3	Fresno	Herndon		Market
PG&E	AGRICO_7_UNIT	34608	AGRICO	13.8	41.41	4	Fresno	Herndon		Market
PG&E	AGRICO_7_UNIT	34608	AGRICO	13.8	7.17	2	Fresno	Herndon		Market
PG&E	AKINGS_6_AMESR1	34688	Q272SPV	0.36	33.21	1	Fresno	Hanford	Aug NQC	Solar
PG&E	AVENAL_6_AVPARK	34265	AVENAL P	12	1.62	1	Fresno	Coalinga	Aug NQC	Solar
PG&E	AVENAL_6_AVSLR1	34691	AVENAL_D	21	0.00	1	Fresno	Coalinga	Energy Only	Solar
PG&E	AVENAL_6_AVSLR2	34691	AVENAL_D	21	0.00	1	Fresno	Coalinga	Energy Only	Solar
PG&E	AVENAL_6_SANDDG	34263	SANDDRAG	12	4.29	1	Fresno	Coalinga	Aug NQC	Solar
PG&E	AVENAL_6_SUNCTY	34257	SUNCTY D	12	5.40	1	Fresno	Coalinga	Aug NQC	Solar

Attachment A - List of physical resources by PTO, local area and market ID

PG&E	BALCHS_7_UNIT 1	34624	BALCH 1	13.2	31.00	1	Fresno	Herndon	Aug NQC	Market
PG&E	BALCHS_7_UNIT 2	34612	BLCH 2-3	13.8	52.50	1	Fresno	Herndon	Aug NQC	Market
PG&E	BALCHS_7_UNIT 3	34614	BLCH 2-3	13.8	54.18	1	Fresno	Herndon	Aug NQC	Market
PG&E	CABALO_2_M2WSR2	365523	Q1036SPV	0.36	27.00	1	Fresno		Aug NQC	Solar
PG&E	CANTUA_1_SOLAR	34349	CANTUA_D	12.5	2.70	1	Fresno	Panoche 115 kV	Aug NQC	Solar
PG&E	CANTUA_1_SOLAR	34349	CANTUA_D	12.5	2.70	2	Fresno	Panoche 115 kV	Aug NQC	Solar
PG&E	CHEVCO_6_UNIT 1	34652	CHV.COAL	9.11	2.54	1	Fresno	Coalinga, Panoche 115 kV	Aug NQC	QF/Selfgen
PG&E	CHEVCO_6_UNIT 2	34652	CHV.COAL	9.11	0.55	2	Fresno	Coalinga, Panoche 115 kV	Aug NQC	QF/Selfgen
PG&E	CHWCHL_1_BIOMAS	34305	CHWCHLA2	13.8	9.00	1	Fresno	Herndon, Panoche 115 kV, Wilson 115 kV	Aug NQC	Market
PG&E	CHWCHL_1_UNIT	34301	CHOWCOGN	13.8	48.00	1	Fresno	Herndon, Panoche 115 kV, Wilson 115 kV		Market
PG&E	CORCAN_1_SOLAR1	34690	CORCORAN	12.5	5.40	FW	Fresno	Herndon, Hanford	Aug NQC	Solar
PG&E	CORCAN_1_SOLAR2	34692	CORCORAN	12.5	2.97	FW	Fresno	Herndon, Hanford	Aug NQC	Solar
PG&E	CRESSY_1_PARKER	34140	CRESSEY	115	1.02		Fresno		Not modeled Aug NQC	MUNI
PG&E	CRNEVL_6_CRNVA	34634	CRANEVLY	12	0.00	1	Fresno	Borden	Aug NQC	Market
PG&E	CRNEVL_6_SJQN 2	34631	SJ2GEN	9.11	0.01	1	Fresno	Borden	Aug NQC	Market
PG&E	CURTIS_1_CANLCK				0.00		Fresno		Not modeled Aug NQC	Market
PG&E	CURTIS_1_FARFLD				0.58		Fresno		Not modeled Aug NQC	Market
PG&E	DAIRLD_1_MD1SL1				0.00		Fresno		Energy Only	Solar
PG&E	DAIRLD_1_MD2BM1				0.00		Fresno		Energy Only	Market
PG&E	DINUBA_6_UNIT	34648	DINUBA E	13.8	0.00	MB	Fresno	Herndon, Reedley	Mothballed	Market
PG&E	EEKTMN_6_SOLAR1	34629	KETTLEMN	0.8	0.00	1	Fresno		Energy Only	Solar
PG&E	ELCAP_1_SOLAR				0.00		Fresno		Not Modeled Aug NQC	Solar
PG&E	ELNIDP_6_BIOMAS	34330	ELNIDO	13.8	9.00	1	Fresno	Panoche 115 kV, Wilson 115 kV	Aug NQC	Market
PG&E	EXCHEC_7_UNIT 1	34306	EXCHQUER	13.8	90.72	1	Fresno	Panoche 115 kV, Wilson 115 kV	Aug NQC	MUNI
PG&E	EXCLSG_1_SOLAR	34623	Q678	0.5	16.20	1	Fresno	Panoche 115 kV	Aug NQC	Solar
PG&E	FRESHW_1_SOLAR1	34699	Q529	0.39	0.00	1	Fresno	Herndon	Energy Only	Solar

Attachment A - List of physical resources by PTO, local area and market ID

PG&E	FRIANT_6_UNITS	34636	FRIANTDM	6.6	7.99	2	Fresno	Borden	Aug NQC	Net Seller
PG&E	FRIANT_6_UNITS	34636	FRIANTDM	6.6	4.27	3	Fresno	Borden	Aug NQC	Net Seller
PG&E	FRIANT_6_UNITS	34636	FRIANTDM	6.6	1.13	4	Fresno	Borden	Aug NQC	Net Seller
PG&E	GIFENS_6_BUGSL1	34644	Q679	0.55	5.40	1	Fresno		Aug NQC	Solar
PG&E	GIFFEN_6_SOLAR	34467	GIFFEN_DIST	12.5	2.70	1	Fresno	Herndon	Aug NQC	Solar
PG&E	GIFFEN_6_SOLAR1				0.00		Fresno	Herndon	Not modeled Energy Only	Solar
PG&E	GUERNS_6_HD3BM3				0.00		Fresno		Not modeled Energy Only	Market
PG&E	GUERNS_6_SOLAR	34463	GUERNSEY_D2	12.5	2.70	5	Fresno		Aug NQC	Solar
PG&E	GUERNS_6_SOLAR	34461	GUERNSEY_D1	12.5	2.70	8	Fresno		Aug NQC	Solar
PG&E	GUERNS_6_VH2BM1				0.00		Fresno		Not modeled Energy Only	Market
PG&E	GWFPWR_1_UNITS	34431	GWF_HEP1	13.8	44.45	1	Fresno	Herndon, Hanford		Market
PG&E	GWFPWR_1_UNITS	34433	GWF_HEP2	13.8	44.45	1	Fresno	Herndon, Hanford		Market
PG&E	HAASPH_7_PL1X2	34610	HAAS	13.8	72.00	1	Fresno	Herndon	Aug NQC	Market
PG&E	HAASPH_7_PL1X2	34610	HAAS	13.8	72.00	2	Fresno	Herndon	Aug NQC	Market
PG&E	HARDWK_6_STWBM1				0.00		Fresno		Not modeled Energy Only	Market
PG&E	HELMPG_7_UNIT 1	34600	HELMS	18	407.00	1	Fresno		Aug NQC	Market
PG&E	HELMPG_7_UNIT 2	34602	HELMS	18	407.00	2	Fresno		Aug NQC	Market
PG&E	HELMPG_7_UNIT 3	34604	HELMS	18	404.00	3	Fresno		Aug NQC	Market
PG&E	HENRTA_6_HDEBT1	34654	HENRIETT	12.5	10.00	1	Fresno			Battery
PG&E	HENRTA_6_SOLAR1				0.41		Fresno		Not modeled Aug NQC	Solar
PG&E	HENRTA_6_SOLAR2				0.00		Fresno		Not modeled Energy Only	Solar
PG&E	HENRTA_6_UNITA1	34539	GWF_GT1	13.8	44.60	1	Fresno			Market
PG&E	HENRTA_6_UNITA2	34541	GWF_GT2	13.8	44.59	1	Fresno			Market
PG&E	HENRTS_1_SOLAR	34617	Q581	0.38	27.00	1	Fresno	Herndon	Aug NQC	Solar
PG&E	HURON_6_SOLAR	34557	HURON_DI	12.5	2.70	1	Fresno	Coalinga, Panoche 115 kV	Aug NQC	Solar
PG&E	HURON_6_SOLAR	34557	HURON_DI	12.5	2.70	2	Fresno	Coalinga, Panoche 115 kV	Aug NQC	Solar
PG&E	INTTRB_6_UNIT	34342	INT.TURB	9.11	3.86	1	Fresno		Aug NQC	Market



Attachment A - List of physical resources by PTO, local area and market ID

PG&E	JAYNE_6_WLSLR	34639	WESTLNDS	0.48	0.00	1	Fresno	Coalinga	Energy Only	Solar
PG&E	KANSAS_6_SOLAR	34666	KANSASS_S	12.5	0.00	F	Fresno		Energy Only	Solar
PG&E	KERKH2_7_UNIT 1	34308	KERCKHOF	13.8	84.00	1	Fresno	Herndon, Wilson 115 kV	Aug NQC	Market
PG&E	KERMAN_6_SOLAR1				0.00		Fresno		Not modeled Energy Only	Solar
PG&E	KERMAN_6_SOLAR2				0.00		Fresno		Not modeled Energy Only	Solar
PG&E	KINGCO_1_KINGBR	34642	KINGSBUR	13.8	21.74	1	Fresno	Herndon, Hanford	Aug NQC	Net Seller
PG&E	KINGCO_1_KINGBR	34642	KINGSBUR	13.8	12.77	2	Fresno	Herndon, Hanford	Aug NQC	Net Seller
PG&E	KINGRV_7_UNIT 1	34616	KINGSRIV	13.8	36.80	1	Fresno	Herndon, Reedley	Aug NQC	Market
PG&E	KNGBRG_1_KBSLR1				0.00		Fresno		Not modeled Energy Only	Solar
PG&E	KNGBRG_1_KBSLR2				0.00		Fresno		Not modeled Energy Only	Solar
PG&E	KNTSTH_6_SOLAR	34694	KENT_S	0.8	0.00	1	Fresno		Energy Only	Solar
PG&E	LEPRFD_1_KANSAS	34680	KANSAS	12.5	5.40	1	Fresno	Herndon, Hanford	Aug NQC	Solar
PG&E	LOTUS_6_LFSR1	34335	Q723SPV	0.32	13.50	1	Fresno	Borden	Aug NQC	Solar
PG&E	LTBEAR_1_LB3SR3	365663	Q1127SPV	0.36	5.40	1	Fresno	Panoche 115 kV, Wilson 115 kV	Aug NQC	Solar
PG&E	LTBEAR_1_LB4SR4	365673	Q1128-4S	0.36	13.50	1	Fresno	Panoche 115 kV, Wilson 115 kV	Aug NQC	Solar
PG&E	LTBEAR_1_LB4SR5	365675	Q1128-5S	0.36	13.50	1	Fresno	Panoche 115 kV, Wilson 115 kV	Aug NQC	Solar
PG&E	LTBERA_1_LB1SR1	365604	Q1028Q10	0.36	10.80	1	Fresno	Panoche 115 kV, Wilson 115 kV	Aug NQC	Solar
PG&E	MALAGA_1_PL1X2	34671	KRCDPCT1	13.8	48.00	1	Fresno	Herndon		Market
PG&E	MALAGA_1_PL1X2	34672	KRCDPCT2	13.8	48.00	1	Fresno	Herndon		Market
PG&E	MCCALL_1_QF	34219	MCCALL 4	12.5	0.48	QF	Fresno	Herndon	Aug NQC	QF/Selfgen
PG&E	MCSWAN_6_UNITS	34320	MCSWAIN	9.11	9.60	1	Fresno	Panoche 115 kV, Wilson 115 kV	Aug NQC	MUNI
PG&E	MENBIO_6_RENEW1	34339	CALRENEW	12.5	1.35	1	Fresno	Herndon, Panoche 115 kV, Wilson 115 kV	Aug NQC	Net Seller
PG&E	MERCED_1_SOLAR1				0.00		Fresno		Not modeled Energy Only	Solar
PG&E	MERCED_1_SOLAR2				0.00		Fresno		Not modeled Energy Only	Solar

Attachment A - List of physical resources by PTO, local area and market ID

PG&E	MERCFL_6_UNIT	34322	MERCEDFL	9.11	3.36	1	Fresno	Panoche 115 kV, Wilson 115 kV	Aug NQC	Market
PG&E	MNDOTA_1_SOLAR1	34313	NORTHSTA	0.2	16.20	1	Fresno	Panoche 115 kV, Wilson 115 kV	Aug NQC	Solar
PG&E	MNDOTA_1_SOLAR2				0.00		Fresno		Not modeled Energy Only	Solar
PG&E	MSTANG_2_MTGBT1	34685	Q643WBES	0.8	75.00	1	Fresno			Battery
PG&E	MSTANG_2_SOLAR	34683	Q643W	0.8	0.00	1	Fresno		Aug NQC	Solar
PG&E	MSTANG_2_SOLAR3	34683	Q643W	0.8	4.04	1	Fresno		Aug NQC	Solar
PG&E	MSTANG_2_SOLAR4	34683	Q643W	0.8	8.10	1	Fresno		Aug NQC	Solar
PG&E	ONLLPP_6_UNITS	34316	ONEILPMP	9.11	0.10	1	Fresno		Aug NQC	MUNI
PG&E	OROLOM_1_SOLAR1	34689	OROLOMA_	12.5	0.00	1	Fresno	Panoche 115 kV	Energy Only	Solar
PG&E	OROLOM_1_SOLAR2	34689	OROLOMA_	12.5	0.00	1	Fresno	Panoche 115 kV	Energy Only	Solar
PG&E	ORTGA_6_ME1SL1				0.81		Fresno		Not modeled Energy Only	Solar
PG&E	PAIGES_6_SOLAR	34653	Q526	0.55	0.00	1	Fresno	Coalinga, Panoche 115 kV	Energy Only	Solar
PG&E	PINFLT_7_UNITS	38720	PINEFLAT	13.8	36.75	1	Fresno	Herndon	Aug NQC	MUNI
PG&E	PINFLT_7_UNITS	38720	PINEFLAT	13.8	36.75	2	Fresno	Herndon	Aug NQC	MUNI
PG&E	PINFLT_7_UNITS	38720	PINEFLAT	13.8	36.75	3	Fresno	Herndon	Aug NQC	MUNI
PG&E	PNCHPP_1_PL1X2	34328	STRWDPNC	13.8	54.50	1	Fresno	Panoche 115 kV		Market
PG&E	PNCHPP_1_PL1X2	34329	STRWDPNC	13.8	54.50	2	Fresno	Panoche 115 kV		Market
PG&E	PNOCHE_1_PL1X2	34142	WHD_PAN2	13.8	49.97	1	Fresno	Herndon, Panoche 115 kV		Market
PG&E	PNOCHE_1_UNITA1	34186	CALPEAKP	13.8	52.01	1	Fresno	Panoche 115 kV		Market
PG&E	REEDLY_6_SOLAR				0.00		Fresno	Herndon, Reedley	Not modeled Energy Only	Solar
PG&E	S_RITA_6_SOLAR1				0.00		Fresno		Not modeled Energy Only	Solar
PG&E	SCHNDR_1_FIVPTS	34353	SCHINDLER_ D	12.5	2.70	1	Fresno	Coalinga, Panoche 115 kV	Aug NQC	Solar
PG&E	SCHNDR_1_FIVPTS	34353	SCHINDLER_ D	12.5	1.35	2	Fresno	Coalinga, Panoche 115 kV	Aug NQC	Solar
PG&E	SCHNDR_1_OS2BM2				0.00		Fresno	Coalinga	Energy Only	Market
PG&E	SCHNDR_1_WSTSDE	34353	SCHINDLER_ D	12.5	2.70	3	Fresno	Coalinga, Panoche 115 kV	Aug NQC	Solar
PG&E	SCHNDR_1_WSTSDE	34353	SCHINDLER_ D	12.5	1.35	4	Fresno	Coalinga, Panoche 115 kV	Aug NQC	Solar

Attachment A - List of physical resources by PTO, local area and market ID

PG&E	SGREGY_6_SANGER	34646	SANGERCG1	13.8	38.77	1	Fresno	Herndon	Aug NQC	Market
PG&E	SGREGY_6_SANGER	34646	SANGERCG2	13.8	9.31	2	Fresno	Herndon	Aug NQC	Market
PG&E	SLATE_2_SLASR1	365694	Q1158S	0.42	31.97	1	Fresno		Aug NQC	Solar
PG&E	STOREY_2_MDRCH2				0.25		Fresno		Not modeled Aug NQC	Market
PG&E	STOREY_2_MDRCH3				0.16		Fresno		Not modeled Aug NQC	Market
PG&E	STOREY_2_MDRCH4				0.17		Fresno		Not modeled Aug NQC	Market
PG&E	STOREY_7_MDRCHW	34209	STOREY D	12.5	0.23	1	Fresno		Aug NQC	Net Seller
PG&E	STROUD_6_SOLAR	34563	STROUD_D	12.5	2.70	1	Fresno	Herndon	Aug NQC	Solar
PG&E	STROUD_6_SOLAR	34563	STROUD_D	12.5	2.70	2	Fresno	Herndon	Aug NQC	Solar
PG&E	STROUD_6_WWHSR1				0.00		Fresno	Herndon	Energy Only	Solar
PG&E	SUMWHT_6_SWSSR1				5.00		Fresno		Aug NQC	Solar
PG&E	TRNQL8_2_AMASR1	365514	Q1032G1	0.55	5.40	1	Fresno		Aug NQC	Solar
PG&E	TRNQL8_2_AZUSR1	365517	Q1032G2	0.55	5.40	2	Fresno		Aug NQC	Solar
PG&E	TRNQL8_2_ROJSR1	365520	Q1032G3	0.55	27.00	3	Fresno		Aug NQC	Solar
PG&E	TRNQL8_2_VERSR1	365520	Q1032G3	0.55	16.20	3	Fresno		Aug NQC	Solar
PG&E	TRNQLT_2_RETBT1	34343	Q643XBES	0.8	33.06	2	Fresno			Battery
PG&E	TRNQLT_2_SOLAR	34340	Q643X	0.8	54.00	1	Fresno		Aug NQC	Solar
PG&E	ULTPFR_1_UNIT 1	34640	RIOBRVOF	12.5	23.85	1	Fresno	Herndon	Aug NQC	Market
PG&E	VEGA_6_SOLAR1	34314	VEGA	34.5	0.00	1	Fresno		Energy Only	Solar
PG&E	WAUKNA_1_SOLAR	34696	CORCORANP V_S	21	5.40	1	Fresno	Herndon, Hanford	Aug NQC	Solar
PG&E	WAUKNA_1_SOLAR2	34677	Q558	21	5.33	1	Fresno	Herndon, Hanford	No NQC - Pmax	Solar
PG&E	WFRESN_1_SOLAR				0.00		Fresno		Not modeled Energy Only	Solar
PG&E	WHITNY_6_SOLAR	34673	Q532	0.55	0.00	1	Fresno	Coalinga, Panoche 115 kV	Energy Only	Solar
PG&E	WISHON_6_UNITS	34658	WISHON	2.3	0.00	1	Fresno	Borden	Aug NQC	Market
PG&E	WISHON_6_UNITS	34658	WISHON	2.3	0.00	2	Fresno	Borden	Aug NQC	Market
PG&E	WISHON_6_UNITS	34658	WISHON	2.3	0.00	3	Fresno	Borden	Aug NQC	Market
PG&E	WISHON_6_UNITS	34658	WISHON	2.3	0.00	4	Fresno	Borden	Aug NQC	Market
PG&E	WISHON_6_UNITS	34658	WISHON	2.3	0.00	SJ	Fresno	Borden	Aug NQC	Market
PG&E	WOODWR_1_HYDRO				0.00		Fresno	Herndon	Not modeled Energy Only	Market

Attachment A - List of physical resources by PTO, local area and market ID

PG&E	WRGHTP_7_AMENGY	34207	WRIGHT D	12.5	0.76	QF	Fresno		Aug NQC	QF/Selfgen
PG&E	ZZ_BORDEN_2_QF	34253	BORDEN D	12.5	0.00	QF	Fresno		No NQC - hist. data	Net Seller
PG&E	ZZ_BULLRD_7_SAGNES	34213	BULLD 12	12.5	0.00	1	Fresno	Herndon	Aug NQC	QF/Selfgen
PG&E	ZZ_KERKH1_7_UNIT 2	34343	KERCK1-2	6.6	0.00	2	Fresno	Herndon, Wilson 115 kV	No NQC - hist. data	Market
PG&E	ZZ_NA	34485	FRESNOWW	12.5	0.00	1	Fresno		No NQC - hist. data	QF/Selfgen
PG&E	ZZ_NA	34485	FRESNOWW	12.5	0.00	2	Fresno		No NQC - hist. data	QF/Selfgen
PG&E	ZZ_NA	34485	FRESNOWW	12.5	0.00	3	Fresno		No NQC - hist. data	QF/Selfgen
PG&E	ZZ_NA	34651	JACALITO	0.55	0.00	RN	Fresno	Coalinga	No NQC - hist. data	Market
PG&E	ZZZ_New Unit	365524	Q1036SPV	0.36	6.20	2	Fresno		Aug NQC	Solar
PG&E	ZZZ_New Unit	365679	Q1136	0.63	5.40	1	Fresno		No NQC - est. data	Solar
PG&E	ZZZ_New Unit	365504	SCULINS	0.55	5.00	1	Fresno		No NQC - est. data	Solar
PG&E	ZZZ_New Unit	34649	Q965SPV	0.36	3.65	1	Fresno	Herndon, Hanford	No NQC - est. data	Solar
PG&E	ZZZ_New Unit	365697	Q1158B	0.27	0.00	2	Fresno		No NQC - est. data	Battery
PG&E	ZZZ_New Unit	92007	2007-RD	70	0.00	ER	Fresno	Borden	Energy Only	Market
PG&E	ZZZ_New Unit	34603	JGBSWLT	12.5	0.00	ST	Fresno	Herndon	Energy Only	Market
PG&E	ZZZZA_New Unit	366004	Q1391SPV	0.6	200.00	1	Fresno		No NQC - est. data	Hybrid
PG&E	ZZZZA_New Unit	34552	GATES	70	165.00	2	Fresno	Coalinga	No NQC - est. data	Battery
PG&E	ZZZZA_New Unit	365695	SLATEBES	0.66	150.00	2	Fresno		No NQC - est. data	Battery
PG&E	ZZZZA_New Unit	365699	SLATEBES	0.66	150.00	4	Fresno		No NQC - est. data	Battery
PG&E	ZZZZA_New Unit	30875	MC CALL	230	100.00	1	Fresno	Herndon	No NQC - est. data	Battery
PG&E	ZZZZA_New Unit	30873	HELM	230	89.00	1	Fresno		No NQC - est. data	Battery
PG&E	ZZZZA_New Unit	34443	RETRQLTY	34.5	38.94	2	Fresno		No NQC - est. data	Battery

Attachment A - List of physical resources by PTO, local area and market ID

PG&E	ZZZZA_New Unit	30792	TRANQLTY	230	35.00	1	Fresno		No NQC - est. data	Battery
PG&E	ZZZZA_New Unit	34685	REMUSTAN	34.5	12.40	2	Fresno		No NQC - est. data	Solar
PG&E	ZZZZA_New Unit	34548	KETTLEMN	70	10.00	1	Fresno	Coalinga	No NQC - est. data	Battery
PG&E	ZZZZA_New Unit	30873	HELM	230	8.06	2	Fresno		No NQC - est. data	Solar
PG&E	ZZZZA_New Unit	30792	TRANQLTY	230	7.44	2	Fresno		No NQC - est. data	Solar
PG&E	ZZZZA_New Unit	365526	TRNQ8VRD	0.55	7.44	4	Fresno		No NQC - est. data	Solar
PG&E	ZZZZA_New Unit	34144	MERCED	115	5.00	1	Fresno		No NQC - est. data	Battery
PG&E	ZZZZA_New Unit	30810	GREGG	230	3.00	1	Fresno		No NQC - est. data	Market
PG&E	ZZZZA_New Unit	34654	HENRIETT	12.5	1.86	2	Fresno		No NQC - est. data	Solar
PG&E	ZZZZA_New Unit	34144	MERCED	115	1.24	2	Fresno		No NQC - est. data	Solar
PG&E	ZZZZA_New Unit	30885	MUSTANG	230	0.00	1	Fresno		No NQC - est. data	Solar
PG&E	ZZZZA_New Unit	34156	MENDOTA	115	0.00	1	Fresno	Panoche 115 kV	No NQC - est. data	Solar
PG&E	ZZZZA_New Unit	34552	GATES	70	0.00	1	Fresno	Coalinga	No NQC - est. data	Solar
PG&E	ZZZZA_New Unit	365694	SLATESPV	0.66	0.00	1	Fresno		No NQC - est. data	Solar
PG&E	ZZZZA_New Unit	30875	MC CALL	230	0.00	2	Fresno	Herndon	No NQC - est. data	Solar
PG&E	ZZZZA_New Unit	365698	SLATESPV	0.66	0.00	3	Fresno		No NQC - est. data	Solar
PG&E	ZZZZA_New Unit	34500	DINUBA	70	0.00	TA	Fresno	Reedley	Transmission Asset	Battery
PG&E	ZZZZZ_CRNEVL_6_SJQN3	34633	SJ3GEN	9.11	0.00	1	Fresno	Borden	Retired	Market
PG&E	ZZZZZ_GATES_6_PL1X2	34553	WHD_GAT2	13.8	0.00	RT	Fresno	Coalinga	Retired	Market
PG&E	ZZZZZ_KERKH1_7_UNIT3	34345	KERCK1-3	6.6	0.00	3	Fresno	Herndon, Wilson 115 kV	Retired	Market

Attachment A - List of physical resources by PTO, local area and market ID

PG&E	BRDGLV_7_BAKER				0.00		Humboldt		Not modeled Aug NQC	Net Seller
PG&E	FTSWRD_6_TRFORK				0.15		Humboldt		Not modeled Aug NQC	Market
PG&E	FTSWRD_7_QFUNTS				0.00		Humboldt		Not modeled Aug NQC	QF/Selfgen
PG&E	HUMBPP_1_UNITS3	31180	HUMB_G1	13.8	16.69	3	Humboldt			Market
PG&E	HUMBPP_1_UNITS3	31180	HUMB_G1	13.8	16.32	1	Humboldt			Market
PG&E	HUMBPP_1_UNITS3	31180	HUMB_G1	13.8	16.22	4	Humboldt			Market
PG&E	HUMBPP_1_UNITS3	31180	HUMB_G1	13.8	15.85	2	Humboldt			Market
PG&E	HUMBPP_6_UNITS	31182	HUMB_G3	13.8	16.62	8	Humboldt			Market
PG&E	HUMBPP_6_UNITS	31181	HUMB_G2	13.8	16.33	6	Humboldt			Market
PG&E	HUMBPP_6_UNITS	31182	HUMB_G3	13.8	16.33	9	Humboldt			Market
PG&E	HUMBPP_6_UNITS	31181	HUMB_G2	13.8	16.24	7	Humboldt			Market
PG&E	HUMBPP_6_UNITS	31181	HUMB_G2	13.8	16.14	5	Humboldt			Market
PG&E	HUMBPP_6_UNITS	31182	HUMB_G3	13.8	15.95	10	Humboldt			Market
PG&E	KEKAWK_6_UNIT	31166	KEKAWAK	9.1	0.00	1	Humboldt		Aug NQC	Net Seller
PG&E	LAPAC_6_UNIT	31158	LP SAMOA	12.5	0.00	1	Humboldt			Market
PG&E	PACLUM_6_UNIT	31152	PAC.LUMB	13.8	5.98	1	Humboldt		Aug NQC	Net Seller
PG&E	PACLUM_6_UNIT	31152	PAC.LUMB	13.8	5.98	2	Humboldt		Aug NQC	Net Seller
PG&E	PACLUM_6_UNIT	31153	PAC.LUMB	2.4	3.59	3	Humboldt		Aug NQC	Net Seller
PG&E	ZZ_FAIRHV_6_UNIT	31150	FAIRHAVN	13.8	0.00	1	Humboldt		No NQC - hist. data	Net Seller
PG&E	ZZZZA_NA	31000	HUMBOLDT		15.00	1	Humboldt		No NQC - est. data	Battery
PG&E	ZZZZA_NA	31000	HUMBOLDT		0.00	2	Humboldt		Energy Only	Wind
PG&E	ZZZZZ_BLULKE_6_BLUELK	31156	BLUELKPP	12.5	0.00	1	Humboldt		Mothballed	Market
PG&E	ZZZZZ_HUMBSB_1_QF				0.00		Humboldt		Retired	QF/Selfgen
PG&E	7STDRD_1_SOLAR1	35065	7STNDRD_D1	21.6	5.40	1	Kern	South Kern PP, Kern Oil	Aug NQC	Solar
PG&E	BDGRCK_1_UNITS	35029	BADGERCK	13.8	43.00	1	Kern	South Kern PP	Aug NQC	Net Seller
PG&E	BEARMT_1_UNIT	35066	PSE-BEAR	13.8	45.00	1	Kern	South Kern PP, Westpark	Aug NQC	Net Seller
PG&E	BKRFLD_2_SOLAR1				0.37		Kern	South Kern PP	Not modeled Aug NQC	Solar
PG&E	DEXZEL_1_UNIT	35024	DEXZEL	13.8	17.52	1	Kern	South Kern PP, Kern Oil	Aug NQC	Net Seller

Attachment A - List of physical resources by PTO, local area and market ID

PG&E	DISCOV_1_CHEVRN	35062	DISCOVERY	13.8	6.20	1	Kern	South Kern PP, Kern Oil	Aug NQC	QF/Selfgen
PG&E	DOUBLC_1_UNITS	35023	DOUBLE C	13.8	26.12	1	Kern	South Kern PP	Aug NQC	Net Seller
PG&E	DOUBLC_1_UNITS	35023	DOUBLE C	13.8	26.12	2	Kern	South Kern PP	Aug NQC	Net Seller
PG&E	KERNFT_1_UNITS	35026	KERNFRNT	13.8	26.20	1	Kern	South Kern PP	Aug NQC	Net Seller
PG&E	KERNFT_1_UNITS	35026	KERNFRNT	13.8	26.20	2	Kern	South Kern PP	Aug NQC	Net Seller
PG&E	LAMONT_1_SOLAR1	35019	REGULUS	0.4	16.20	1	Kern	South Kern PP, Kern PWR-Tevis	Aug NQC	Solar
PG&E	LAMONT_1_SOLAR2	35092	REDWOODSP V	0.6	5.40	4	Kern	South Kern PP, Kern PWR-Tevis	Aug NQC	Solar
PG&E	LAMONT_1_SOLAR3	35087	WOODMERES PV	0.4	4.05	3	Kern	South Kern PP, Kern PWR-Tevis	Aug NQC	Solar
PG&E	LAMONT_1_SOLAR4	35059	HAYWORTH PV	0.4	18.12	2	Kern	South Kern PP, Kern PWR-Tevis	Aug NQC	Solar
PG&E	LAMONT_1_SOLAR5	35054	REDCRESTS PV	0.4	4.50	1	Kern	South Kern PP, Kern PWR-Tevis	Aug NQC	Solar
PG&E	LIVOAK_1_UNIT 1	35058	PSE-LVOK	9.1	43.00	1	Kern	South Kern PP, Kern Oil	Aug NQC	Net Seller
PG&E	MAGUND_1_BKISR1				0.27		Kern	South Kern PP, Kern Oil	Not modeled Aug NQC	Solar
PG&E	MAGUND_1_BKSSR2				1.42		Kern	South Kern PP, Kern Oil	Not modeled Aug NQC	Solar
PG&E	MTNPOS_1_UNIT	35036	MT POSO	13.8	41.93	1	Kern	South Kern PP, Kern Oil	Aug NQC	Net Seller
PG&E	OLDRIV_6_BIOGAS				1.72		Kern	South Kern PP, Kern 70 kV	Not modeled Aug NQC	Market
PG&E	OLDRIV_6_CESDBM				0.93		Kern	South Kern PP, Kern 70 kV	Not modeled Aug NQC	Market
PG&E	OLDRIV_6_LKVBM1				0.93		Kern	South Kern PP, Kern 70 kV	Not modeled Aug NQC	Market
PG&E	OLDRV1_6_SOLAR	35091	OLD_RVR1	12.5	5.40	1	Kern	South Kern PP, Kern 70 kV	Aug NQC	Solar
PG&E	SIERRA_1_UNITS	35027	HISIERRA	13.8	26.22	1	Kern	South Kern PP	Aug NQC	Market
PG&E	SIERRA_1_UNITS	35027	HISIERRA	13.8	26.22	2	Kern	South Kern PP	Aug NQC	Market
PG&E	SKERN_6_SOLAR1	35089	S_KERN	0.48	5.40	1	Kern	South Kern PP, Kern 70 kV	Aug NQC	Solar
PG&E	SKERN_6_SOLAR2	365563	SKICSPV	0.4	2.70	1	Kern	South Kern PP, Kern 70 kV	Aug NQC	Solar

Attachment A - List of physical resources by PTO, local area and market ID

PG&E	VEDDER_1_SEKERN	35046	SEKR	9.11	0.01	1	Kern	South Kern PP, Kern Oil	Aug NQC	QF/Selfgen
PG&E	ZZZ_New Unit	365597	Q744P5G5	0.6	3.21	5	Kern	South Kern PP, Kern PWR-Tevis	No NQC - est. data	Solar
PG&E	ZZZ_New Unit	35058	EANDB_D1	9.1	0.00	RE	Kern	South Kern PP	No NQC - est. data	Market
PG&E	ZZZZA_New Unit	34758	LAMONT	115	95.00	2	Kern	South Kern PP, Kern PWR-Tevis	No NQC - Pmax	Battery
PG&E	ZZZZA_New Unit	34724	KRN OL J	115	1.24	1	Kern	South Kern PP, Kern Oil	No NQC - est. data	Solar
PG&E	ZZZZA_New Unit	34714	LERDO	115	0.62	1	Kern	South Kern PP, Kern Oil	No NQC - est. data	Solar
PG&E	ZZZZA_New Unit	34758	LAMONT	115	0.50	1	Kern	South Kern PP, Kern PWR-Tevis	No NQC - est. data	Solar
PG&E	ZZZZA_New Unit	30940	STCKDLEA	230	0.50	1	Kern	South Kern PP	No NQC - est. data	Solar
PG&E	ZZZZA_New Unit	34758	LAMONT	115	0.00	3	Kern	South Kern PP, Kern PWR-Tevis	No NQC - est. data	Solar
PG&E	ADLIN_1_UNITS	31435	GEO.ENGY	9.1	11.00	1	NCNB	Eagle Rock, Fulton		Market
PG&E	ADLIN_1_UNITS	31435	GEO.ENGY	9.1	11.00	2	NCNB	Eagle Rock, Fulton		Market
PG&E	CLOVDL_1_SOLAR				0.41		NCNB	Eagle Rock, Fulton	Not modeled Aug NQC	Solar
PG&E	CSTOGA_6_LNDFIL				0.00		NCNB	Fulton	Not modeled Energy Only	Market
PG&E	FULTON_1_QF				0.04		NCNB	Fulton	Not modeled Aug NQC	QF/Selfgen
PG&E	GEYS11_7_UNIT11	31412	GEYSER11	13.8	68.00	1	NCNB	Eagle Rock, Fulton		Market
PG&E	GEYS12_7_UNIT12	31414	GEYSER12	13.8	50.00	1	NCNB	Fulton		Market
PG&E	GEYS13_7_UNIT13	31416	GEYSER13	13.8	56.00	1	NCNB			Market
PG&E	GEYS14_7_UNIT14	31418	GEYSER14	13.8	50.00	1	NCNB	Fulton		Market
PG&E	GEYS16_7_UNIT16	31420	GEYSER16	13.8	49.00	1	NCNB	Fulton		Market
PG&E	GEYS17_7_UNIT17	31422	GEYSER17	13.8	56.00	1	NCNB	Fulton		Market
PG&E	GEYS18_7_UNIT18	31424	GEYSER18	13.8	45.00	1	NCNB			Market
PG&E	GEYS20_7_UNIT20	31426	GEYSER20	13.8	50.00	1	NCNB			Market
PG&E	GYS5X6_7_UNITS	31406	GEYSR5-6	13.8	42.50	1	NCNB	Eagle Rock, Fulton		Market



Attachment A - List of physical resources by PTO, local area and market ID

PG&E	GYS5X6_7_UNITS	31406	GEYSR5-6	13.8	42.50	2	NCNB	Eagle Rock, Fulton		Market
PG&E	GYS7X8_7_UNITS	31408	GEYSER78	13.8	47.90	1	NCNB	Eagle Rock, Fulton		Market
PG&E	GYS7X8_7_UNITS	31408	GEYSER78	13.8	47.90	2	NCNB	Eagle Rock, Fulton		Market
PG&E	GYSRVL_7_WSPRNG				1.48		NCNB	Fulton	Not modeled Aug NQC	QF/Selfgen
PG&E	HILAND_7_YOLOWD				0.00		NCNB	Eagle Rock, Fulton	Not Modeled. Energy Only	Market
PG&E	IGNACO_1_QF				0.00		NCNB		Not modeled Aug NQC	QF/Selfgen
PG&E	INDVLY_1_UNITS	31436	INDIAN V	9.1	1.59	1	NCNB	Eagle Rock, Fulton	Aug NQC	Net Seller
PG&E	MONTPH_7_UNITS	32700	MONTICLO	9.1	3.29	1	NCNB	Fulton	Aug NQC	Market
PG&E	MONTPH_7_UNITS	32700	MONTICLO	9.1	3.29	2	NCNB	Fulton	Aug NQC	Market
PG&E	MONTPH_7_UNITS	32700	MONTICLO	9.1	0.99	3	NCNB	Fulton	Aug NQC	Market
PG&E	NCPA_7_GP1UN1	38106	NCPA1GY1	13.8	38.85	1	NCNB		Aug NQC	MUNI
PG&E	NCPA_7_GP1UN2	38108	NCPA1GY2	13.8	39.94	1	NCNB		Aug NQC	MUNI
PG&E	NCPA_7_GP2UN3	38110	NCPA2GY1	13.8	0.00	1	NCNB	Fulton	Aug NQC	MUNI
PG&E	NCPA_7_GP2UN4	38112	NCPA2GY2	13.8	52.73	1	NCNB	Fulton	Aug NQC	MUNI
PG&E	NOVATO_6_LNDFL				3.56		NCNB		Not modeled Aug NQC	Market
PG&E	POTTER_6_UNITS	31433	POTTRVLY	2.4	1.08	1	NCNB	Eagle Rock, Fulton	Aug NQC	Market
PG&E	POTTER_6_UNITS	31433	POTTRVLY	2.4	0.49	3	NCNB	Eagle Rock, Fulton	Aug NQC	Market
PG&E	POTTER_6_UNITS	31433	POTTRVLY	2.4	0.49	4	NCNB	Eagle Rock, Fulton	Aug NQC	Market
PG&E	POTTER_7_VECINO				0.00		NCNB	Eagle Rock, Fulton	Not modeled Aug NQC	QF/Selfgen
PG&E	SANTFG_7_UNITS	31400	SANTA FE	13.8	36.00	1	NCNB			Market
PG&E	SANTFG_7_UNITS	31400	SANTA FE	13.8	36.00	2	NCNB			Market
PG&E	SMUDGO_7_UNIT 1	31430	SMUDGE01	13.8	47.00	1	NCNB			Market
PG&E	SNMALF_6_UNITS	31446	SONMA LF	9.1	3.15	1	NCNB	Fulton	Aug NQC	QF/Selfgen
PG&E	UKIAH_7_LAKEMN	38020	CITY UKH	115	1.21	2	NCNB	Eagle Rock, Fulton	Aug NQC	MUNI
PG&E	UKIAH_7_LAKEMN	38020	CITY UKH	115	0.49	1	NCNB	Eagle Rock, Fulton	Aug NQC	MUNI

Attachment A - List of physical resources by PTO, local area and market ID

PG&E	ZZ_GEYS17_2_BOTRCK	31421	BOTTLERK	13.8	0.00	1	NCNB	Fulton	Energy Only and Mothballed	Market
PG&E	ZZZZZ_BEARN_2_UNIT S	31402	BEAR CAN	13.8	0.00	1	NCNB	Fulton	Retired	Market
PG&E	ZZZZZ_BEARN_2_UNIT S	31402	BEAR CAN	13.8	0.00	2	NCNB	Fulton	Retired	Market
PG&E	ZZZZZ_WDFRDF_2_UNIT S	31404	WEST FOR	13.8	0.00	1	NCNB	Fulton	Retired	Market
PG&E	ZZZZZ_WDFRDF_2_UNIT S	31404	WEST FOR	13.8	0.00	2	NCNB	Fulton	Retired	Market
PG&E	ALLGNY_6_HYDRO1				0.03		Sierra		Not modeled Aug NQC	Market
PG&E	APLHIL_1_SLABCK				0.00		Sierra	South of Rio Oso, South of Palermo	Retired Not modeled Energy Only	Market
PG&E	BANGOR_6_HYDRO				0.40		Sierra		Not modeled Aug NQC	Market
PG&E	BELDEN_7_UNIT 1	31784	BELDEN	13.8	88.00	1	Sierra	South of Palermo	Aug NQC	Market
PG&E	BIOMAS_1_UNIT 1	32156	WOODLAND	13.8	15.80	1	Sierra	Drum-Rio Oso, South of Palermo	Aug NQC	Net Seller
PG&E	BNNIEN_7_ALTAPH	32376	BONNIE N	60	0.73		Sierra	Placer, Gold Hill-Drum, Drum-Rio Oso, South of Rio Oso, South of Palermo	Not modeled Aug NQC	Market
PG&E	BOGUE_1_UNITA1	32451	FREC	13.8	47.60	1	Sierra	Bogue, Drum-Rio Oso	Aug NQC	Market
PG&E	BOWMN_6_HYDRO	32480	BOWMAN	9.11	2.54	1	Sierra	Drum-Rio Oso, South of Palermo	Aug NQC	MUNI
PG&E	BUCKCK_2_HYDRO				0.08		Sierra	South of Palermo	Not modeled Aug NQC	Market
PG&E	BUCKCK_7_OAKFLT				0.77		Sierra	South of Palermo	Not modeled Aug NQC	Market
PG&E	BUCKCK_7_PL1X2	31820	BCKS CRK	11	25.36	1	Sierra	South of Palermo	Aug NQC	Market
PG&E	BUCKCK_7_PL1X2	31820	BCKS CRK	11	22.04	2	Sierra	South of Palermo	Aug NQC	Market
PG&E	CAMPFW_7_FARWST	32470	CMP.FARW	9.11	3.10	1	Sierra		Aug NQC	MUNI

Attachment A - List of physical resources by PTO, local area and market ID

PG&E	CHICPK_7_UNIT 1	32462	CHI.PARK	11.5	27.20	1	Sierra	Placer, Gold Hill-Drum, Drum-Rio Oso, South of Rio Oso, South of Palermo	Aug NQC	MUNI
PG&E	COLGAT_7_UNIT 1	32450	COLGATE1	13.8	161.00	1	Sierra		Aug NQC	MUNI
PG&E	COLGAT_7_UNIT 2	32452	COLGATE2	13.8	161.00	1	Sierra		Aug NQC	MUNI
PG&E	CRESTA_7_PL1X2	31812	CRESTA	11.5	25.24	2	Sierra	South of Palermo	Aug NQC	Market
PG&E	CRESTA_7_PL1X2	31812	CRESTA	11.5	24.76	1	Sierra	South of Palermo	Aug NQC	Market
PG&E	DAVIS_1_SOLAR1				0.00		Sierra	Drum-Rio Oso, South of Palermo	Not modeled Energy Only	Solar
PG&E	DAVIS_1_SOLAR2				0.00		Sierra	Drum-Rio Oso, South of Palermo	Not modeled Aug NQC	Solar
PG&E	DAVIS_7_MNMETH				2.34		Sierra	Drum-Rio Oso, South of Palermo	Not modeled Aug NQC	Market
PG&E	DEADCK_1_UNIT	31862	DEADWOOD	9.11	0.02	1	Sierra	Drum-Rio Oso	Aug NQC	MUNI
PG&E	DEERCR_6_UNIT 1	32474	DEER CRK	2.4	2.88	1	Sierra	Drum-Rio Oso, South of Palermo	Aug NQC	Market
PG&E	DRUM_7_PL1X2	32504	DRUM 1-2	6.6	5.20	1	Sierra	Drum-Rio Oso, South of Palermo	Aug NQC	Market
PG&E	DRUM_7_PL1X2	32504	DRUM 1-2	6.6	5.20	2	Sierra	Drum-Rio Oso, South of Palermo	Aug NQC	Market
PG&E	DRUM_7_PL3X4	32506	DRUM 3-4	6.6	6.93	2	Sierra	Drum-Rio Oso, South of Palermo	Aug NQC	Market
PG&E	DRUM_7_PL3X4	32506	DRUM 3-4	6.6	5.87	1	Sierra	Drum-Rio Oso, South of Palermo	Aug NQC	Market
PG&E	DRUM_7_UNIT 5	32454	DRUM 5	13.8	47.74	1	Sierra	Drum-Rio Oso, South of Palermo	Aug NQC	Market
PG&E	DUTCH1_7_UNIT 1	32464	DTCHFLT1	11	20.40	1	Sierra	Placer, Gold Hill-Drum, Drum-Rio Oso, South of Rio Oso, South of Palermo	Aug NQC	Market
PG&E	DUTCH2_7_UNIT 1	32502	DTCHFLT2	6.9	15.21	1	Sierra	Drum-Rio Oso, South of Palermo	Aug NQC	MUNI
PG&E	ELDORO_7_UNIT 1	32513	ELDRADO1	21.6	1.94	1	Sierra	Gold Hill-Drum, South of Rio Oso, South of Palermo		Market

Attachment A - List of physical resources by PTO, local area and market ID

PG&E	ELDORO_7_UNIT 2	32514	ELDRADO2	21.6	4.79	1	Sierra	Gold Hill-Drum, South of Rio Oso, South of Palermo		Market
PG&E	FMEADO_6_HELLHL	32486	HELLHOLE	9.11	0.44	1	Sierra	South of Rio Oso, South of Palermo	Aug NQC	MUNI
PG&E	FMEADO_7_UNIT	32508	FRNCH MD	4.2	16.00	1	Sierra	South of Rio Oso, South of Palermo	Aug NQC	MUNI
PG&E	FORBST_7_UNIT 1	31814	FORBSTWN	11.5	37.50	1	Sierra	Drum-Rio Oso	Aug NQC	MUNI
PG&E	GRIDLY_6_SOLAR	38054	GRIDLEY	60	0.00	1	Sierra	Pease	Energy Only	Solar
PG&E	GRIZLY_1_UNIT 1	31900	GRIZLYG	6.9	20.00	1	Sierra	South of Palermo	Aug NQC	MUNI
PG&E	GRNLF2_1_UNIT	32492	GRNLEAF2	13.8	49.20	1	Sierra	Pease, Drum-Rio Oso	Aug NQC	QF/Selfgen
PG&E	HALSEY_6_UNIT	32478	HALSEY F	6.6	5.76	1	Sierra	Placer, Gold Hill- Drum, Drum-Rio Oso, South of Rio Oso, South of Palermo	Aug NQC	Market
PG&E	HAYPRS_6_HAYHD1	32488	HAYPRES+	9.11	0.04	1	Sierra	Drum-Rio Oso, South of Palermo	Aug NQC	Market
PG&E	HAYPRS_6_HAYHD2	32488	HAYPRES+	9.11	0.04	2	Sierra	Drum-Rio Oso, South of Palermo	Aug NQC	Market
PG&E	HIGGNS_1_COMBIE				0.67		Sierra	Drum-Rio Oso, South of Rio Oso, South of Palermo	Not modeled Aug NQC	Market
PG&E	HIGGNS_7_QFUNTS				0.25		Sierra	Drum-Rio Oso, South of Rio Oso, South of Palermo	Not modeled Aug NQC	QF/Selfgen
PG&E	KELYRG_6_UNIT	31834	KELLYRDG	4.16	11.00	1	Sierra	Drum-Rio Oso	Aug NQC	MUNI
PG&E	LIVEOK_6_SOLAR				0.14		Sierra	Pease	Not modeled Aug NQC	Solar
PG&E	LODIEC_2_PL1X2	38123	LODIECCT	18	199.03	1	Sierra	South of Rio Oso, South of Palermo		MUNI
PG&E	LODIEC_2_PL1X2	38124	LODIECST	18	103.55	1	Sierra	South of Rio Oso, South of Palermo		MUNI
PG&E	MDFKRL_2_PROJECT	32458	RALSTON	13.8	82.13	1	Sierra	South of Rio Oso, South of Palermo	Aug NQC	MUNI
PG&E	MDFKRL_2_PROJECT	32456	MIDLFORK	13.8	63.94	1	Sierra	South of Rio Oso, South of Palermo	Aug NQC	MUNI

Attachment A - List of physical resources by PTO, local area and market ID

PG&E	MDFKRL_2_PROJECT	32456	MIDLFORK	13.8	63.94	2	Sierra	South of Rio Oso, South of Palermo	Aug NQC	MUNI
PG&E	NAROW1_2_UNIT	32466	NARROWS1	11	12.00	1	Sierra		Aug NQC	Market
PG&E	NAROW2_2_UNIT	32468	NARROWSPH 2	13.8	55.00	1	Sierra		Aug NQC	MUNI
PG&E	NWCSTL_7_UNIT 1	32460	NEWCASTLE	13.2	0.64	1	Sierra	Placer, Gold Hill- Drum, Drum-Rio Oso, South of Rio Oso, South of Palermo	Aug NQC	Market
PG&E	OROVIL_6_UNIT	31888	OROVLENRG	4.16	7.50	1	Sierra	Drum-Rio Oso	Aug NQC	Market
PG&E	OXBOW_6_DRUM	32484	OXBOW F	9.11	3.70	1	Sierra	Drum-Rio Oso, South of Palermo	Aug NQC	MUNI
PG&E	PLACVL_1_CHILIB	32510	CHILIBAR	4.2	3.11	1	Sierra	Gold Hill-Drum, South of Rio Oso, South of Palermo	Aug NQC	Market
PG&E	PLACVL_1_RCKCRE				0.00		Sierra	South of Rio Oso, South of Palermo	Not modeled Aug NQC	Market
PG&E	PLSNTG_7_LNCLND	32408	PLSNT GR	60	3.16		Sierra	Drum-Rio Oso, South of Rio Oso, South of Palermo	Not modeled Aug NQC	Market
PG&E	POEPH_7_UNIT 1	31790	POE 1	13.8	45.60	1	Sierra	South of Palermo	Aug NQC	Market
PG&E	POEPH_7_UNIT 2	31792	POE 2	13.8	42.64	1	Sierra	South of Palermo	Aug NQC	Market
PG&E	RCKCRK_7_UNIT 1	31786	ROCK CK1	13.8	32.00	1	Sierra	South of Palermo	Aug NQC	Market
PG&E	RCKCRK_7_UNIT 2	31788	ROCK CK2	13.8	40.00	1	Sierra	South of Palermo	Aug NQC	Market
PG&E	RIOOSO_1_QF				0.89		Sierra	Drum-Rio Oso, South of Palermo	Not modeled Aug NQC	QF/Selfgen
PG&E	ROLLIN_6_UNIT	32476	ROLLINSF	6.6	6.69	1	Sierra	Drum-Rio Oso, South of Palermo	Aug NQC	MUNI
PG&E	SLYCRK_1_UNIT 1	31832	SLY.CR.	6.6	13.00	1	Sierra	Drum-Rio Oso	Aug NQC	MUNI
PG&E	SPAULD_6_UNIT 3	32472	SPAULDG	9.11	3.76	3	Sierra	Drum-Rio Oso, South of Palermo	Aug NQC	Market
PG&E	SPAULD_6_UNIT12	32472	SPAULDG	9.11	2.47	1	Sierra	Drum-Rio Oso, South of Palermo	Aug NQC	Market
PG&E	SPAULD_6_UNIT12	32472	SPAULDG	9.11	1.56	2	Sierra	Drum-Rio Oso, South of Palermo	Aug NQC	Market
PG&E	SPI LI_2_UNIT 1	32498	SPILINCF	12.5	9.65	1	Sierra	Drum-Rio Oso, South of Rio Oso, South of Palermo	Aug NQC	Net Seller

Attachment A - List of physical resources by PTO, local area and market ID

PG&E	STIGCT_2_LODI	38114	STIG CC	13.8	49.50	1	Sierra	South of Rio Oso, South of Palermo		MUNI
PG&E	ULTRCK_2_UNIT	32500	RBROCKLI	12.5	23.72	1	Sierra	Drum-Rio Oso, South of Rio Oso, South of Palermo	Aug NQC	Market
PG&E	WDLEAF_7_UNIT 1	31794	WOODLEAF	13.8	60.00	1	Sierra	Drum-Rio Oso	Aug NQC	MUNI
PG&E	WHEATL_6_LNDFIL	32350	WHEATLND	60	3.55		Sierra		Not modeled Aug NQC	Market
PG&E	WISE_1_UNIT 1	32512	WISE	12	8.64	1	Sierra	Placer, Gold Hill- Drum, Drum-Rio Oso, South of Rio Oso, South of Palermo	Aug NQC	Market
PG&E	WISE_1_UNIT 2	32512	WISE	12	0.00	1	Sierra	Placer, Gold Hill- Drum, Drum-Rio Oso, South of Rio Oso, South of Palermo	Aug NQC	Market
PG&E	YUBACT_1_SUNSWT	32494	YUBA CTY	13.8	49.97	1	Sierra	Pease, Drum-Rio Oso	Aug NQC	Net Seller
PG&E	YUBACT_6_UNITA1	32496	YCEC	13.8	47.60	1	Sierra	Pease, Drum-Rio Oso		Market
PG&E	ZZ_NA	32162	RIV.DLTA	9.11	0.00	1	Sierra	Drum-Rio Oso, South of Palermo	No NQC - hist. data	QF/Selfgen
PG&E	ZZ_UCDAVS_1_UNIT	32166	UC DAVIS	9.11	0.00	RN	Sierra	Drum-Rio Oso, South of Palermo	No NQC - hist. data	QF/Selfgen
PG&E	ZZZ_New Unit	365936	Q653FSPV	0.12	2.46	1	Sierra	Drum-Rio Oso, South of Palermo	No NQC - est. data	Solar
PG&E	ZZZ_New Unit	365940	Q653FSPV	0.12	2.46	2	Sierra	Drum-Rio Oso, South of Palermo	No NQC - est. data	Solar
PG&E	ZZZ_New Unit	365938	Q653FC6B	0.48	0.00	3	Sierra	Drum-Rio Oso, South of Palermo	No NQC - est. data	Battery
PG&E	ZZZZA_New Unit	32232	HIGGINS	115	25.00	1	Sierra	Placer, Gold Hill- Drum, Drum-Rio Oso, South of Rio Oso, South of Palermo	No NQC - est. data	Market
PG&E	ZZZZA_New Unit	30325	PALERMO	230	5.00	1	Sierra	Drum-Rio Oso	No NQC - est. data	Market

Attachment A - List of physical resources by PTO, local area and market ID

PG&E	ZZZZA_New Unit	31480	WYANDTT	115	3.60	1	Sierra	Drum-Rio Oso	No NQC - est. data	Market
PG&E	ZZZZA_New Unit	32228	PLACER	115	3.00	1	Sierra	Placer, Gold Hill-Drum, Drum-Rio Oso, South of Rio Oso, South of Palermo	No NQC - est. data	Market
PG&E	ZZZZZ_GOLDHL_1_QF				0.00		Sierra	South of Rio Oso, South of Palermo	Retired	QF/Selfgen
PG&E	ZZZZZ_GRNLF1_1_UNITS	32490	GRNLEAF1	13.8	0.00	1	Sierra	Bogue, Drum-Rio Oso	Retired	Market
PG&E	ZZZZZ_GRNLF1_1_UNITS	32491	GRNLEAF1	13.8	0.00	2	Sierra	Bogue, Drum-Rio Oso	Retired	Market
PG&E	ZZZZZ_KANAKA_1_UNIT				0.00		Sierra	Drum-Rio Oso	Retired	MUNI
PG&E	ZZZZZ_PACORO_6_UNIT	31890	PO POWER	9.11	0.00	1	Sierra	Drum-Rio Oso	Retired	QF/Selfgen
PG&E	ZZZZZ_PACORO_6_UNIT	31890	PO POWER	9.11	0.00	2	Sierra	Drum-Rio Oso	Retired	QF/Selfgen
PG&E	BEARDS_7_UNIT 1	34074	BEARDSLY	6.9	6.76	1	Stockton	Tesla-Bellota, Stanislaus	Aug NQC	MUNI
PG&E	CAMCHE_1_PL1X3	33850	CAMANCHE	4.2	0.99	1	Stockton	Tesla-Bellota	Aug NQC	MUNI
PG&E	CAMCHE_1_PL1X3	33850	CAMANCHE	4.2	0.99	2	Stockton	Tesla-Bellota	Aug NQC	MUNI
PG&E	CAMCHE_1_PL1X3	33850	CAMANCHE	4.2	0.99	3	Stockton	Tesla-Bellota	Aug NQC	MUNI
PG&E	CENT40_1_C40SR1	365684	Q1103SPV	0.32	10.80	1	Stockton	Tesla-Bellota	Aug NQC	Solar
PG&E	CRWCKS_1_SOLAR1	34051	Q539	34.5	0.00	1	Stockton	Tesla-Bellota	Energy Only	Solar
PG&E	DONNLS_7_UNIT	34058	DONNELLS	13.8	72.00	1	Stockton	Tesla-Bellota, Stanislaus	Aug NQC	MUNI
PG&E	FROGTN_1_UTICAA				0.56		Stockton	Tesla-Bellota, Stanislaus	Not Modeled Aug NQC	Market
PG&E	FROGTN_1_UTICAM				1.83		Stockton	Tesla-Bellota, Stanislaus	Not Modeled Aug NQC	Market
PG&E	LOCKFD_1_BEARCK				0.41		Stockton	Tesla-Bellota	Not Modeled Aug NQC	Solar
PG&E	LOCKFD_1_KSOLAR				0.27		Stockton	Tesla-Bellota	Not Modeled Aug NQC	Solar
PG&E	LODI25_2_UNIT 1	38120	LODI25CT	13.8	23.80	1	Stockton	Lockeford		MUNI
PG&E	MANTEC_1_ML1SR1				0.00		Stockton	Tesla-Bellota	Not modeled Energy Only	Solar
PG&E	PEORIA_1_SOLAR				0.41		Stockton	Tesla-Bellota, Stanislaus	Not modeled Aug NQC	Solar

Attachment A - List of physical resources by PTO, local area and market ID

PG&E	PHOENX_1_UNIT				0.91		Stockton	Tesla-Bellota, Stanislaus	Not modeled Aug NQC	Market
PG&E	SCHLTE_1_PL1X3	33811	GWFTRCY3	13.8	137.50	1	Stockton	Tesla-Bellota		Market
PG&E	SCHLTE_1_PL1X3	33805	GWFTRCY1	13.8	85.33	1	Stockton	Tesla-Bellota		Market
PG&E	SCHLTE_1_PL1X3	33807	GWFTRCY2	13.8	85.33	1	Stockton	Tesla-Bellota		Market
PG&E	SNDBAR_7_UNIT 1	34060	SANDBAR	13.8	11.56	1	Stockton	Tesla-Bellota, Stanislaus	Aug NQC	MUNI
PG&E	SPIFBD_1_PL1X2	34055	SPISONOR	13.8	3.59	1	Stockton	Tesla-Bellota, Stanislaus	Aug NQC	Market
PG&E	SPRGAP_1_UNIT 1	34078	SPRNG GP	6	0.09	1	Stockton	Tesla-Bellota, Stanislaus	Aug NQC	Market
PG&E	STANIS_7_UNIT 1	34062	STANISLS	13.8	63.20	1	Stockton	Tesla-Bellota, Stanislaus	Aug NQC	Market
PG&E	STNRES_1_UNIT	34056	COVANTAS	13.8	19.34	1	Stockton	Tesla-Bellota	Aug NQC	Net Seller
PG&E	TULLCK_7_UNITS	34076	TULLOCH	6.9	7.02	2	Stockton	Tesla-Bellota	Aug NQC	MUNI
PG&E	TULLCK_7_UNITS	34076	TULLOCH	6.9	6.24	1	Stockton	Tesla-Bellota	Aug NQC	MUNI
PG&E	TULLCK_7_UNITS	34076	TULLOCH	6.9	4.61	3	Stockton	Tesla-Bellota	Aug NQC	MUNI
PG&E	ULTPCH_1_UNIT 1	34050	CH.STN.	13.8	17.98	1	Stockton	Tesla-Bellota, Stanislaus	Aug NQC	Market
PG&E	VLYHOM_7_SSJID				0.74		Stockton	Tesla-Bellota, Stanislaus	Not modeled Aug NQC	MUNI
PG&E	ZZZ_New Unit	365769	Q1116BES	12.5	10.00	1	Stockton	Tesla-Bellota	No NQC - est. data	Battery
PG&E	ZZZ_New Unit	365556	SAFEWAYB	12.5	0.00	RN	Stockton	Tesla-Bellota	Energy Only	Market
PG&E	ZZZZA_New Unit	39343	Q1109	0.48	132.00	1	Stockton	Tesla-Bellota, Stanislaus	No NQC - est. data	Battery
PG&E	ZZZZA_New Unit	366130	Q1350BES	0.69	10.50	1	Stockton	Tesla-Bellota	No NQC - est. data	Battery
PG&E	ZZZZA_New Unit	33916	CURTIS	115	9.00	1	Stockton	Tesla-Bellota, Stanislaus	No NQC - est. data	Market
PG&E	ZZZZA_New Unit	33562	BELLOTA	115	4.00	1	Stockton	Tesla-Bellota, Stanislaus	No NQC - est. data	Market
PG&E	ZZZZA_New Unit	366966	Q1350SPV	0.66	3.78	2	Stockton	Tesla-Bellota	No NQC - est. data	Solar
PG&E	ZZZZA_New Unit	33562	BELLOTA	115	0.00	2	Stockton	Tesla-Bellota, Stanislaus	No NQC - est. data	Market
PG&E	ZZZZZZ_NA	33830	GEN.MILL	9.11	0.00	1	Stockton	Lockeford	Retired	QF/Selfgen
PG&E	ZZZZZZ_SANJOA_1_UNIT 1	33808	SJ COGEN	13.8	0.00	1	Stockton	Tesla-Bellota	Retired	QF/Selfgen



Attachment A - List of physical resources by PTO, local area and market ID

PG&E	ZZZZZZ_SMPRIP_1_SM PSON	33810	SP CMPNY	13.8	46.05	1	Stockton	Tesla-Bellota	Aug NQC	Market
SCE	ACACIA_6_SOLAR	29878	ACACIA_G	0.48	5.40	EQ	BC/Ventura		Aug NQC	Solar
SCE	ALAMO_6_UNIT	25653	ALAMO SC	13.8	7.71	1	BC/Ventura		Aug NQC	MUNI
SCE	BGSKYN_2_AS2SR1	29773	ANT2_EXP	0.63	28.35	EQ	BC/Ventura		Aug NQC	Solar
SCE	BGSKYN_2_ASPSR2	29776	ANT2_SPA	0.6	27.00	EQ	BC/Ventura		Aug NQC	Solar
SCE	BGSKYN_2_ASSR3A	29745	BSKY_G_DSR 3	0.6	4.05	1	BC/Ventura		Aug NQC	Solar
SCE	BGSKYN_2_ASSR3B	29745	BSKY_G_DSR 3	0.6	1.35	1	BC/Ventura		Aug NQC	Solar
SCE	BGSKYN_2_BS3SR3	29774	ANTLP2_P45_ G	0.44	5.40	EQ	BC/Ventura		Aug NQC	Solar
SCE	BIGCRK_2_EXESWD	24317	MAMOTH1G	13.8	80.45	1	BC/Ventura	Rector, Vestal	Aug NQC	Market
SCE	BIGCRK_2_EXESWD	24318	MAMOTH2G	13.8	80.45	2	BC/Ventura	Rector, Vestal	Aug NQC	Market
SCE	BIGCRK_2_EXESWD	24308	B CRK2-1	13.8	44.74	2	BC/Ventura	Rector, Vestal	Aug NQC	Market
SCE	BIGCRK_2_EXESWD	24308	B CRK2-1	13.8	43.71	1	BC/Ventura	Rector, Vestal	Aug NQC	Market
SCE	BIGCRK_2_EXESWD	24314	B CRK 4	11.5	43.54	42	BC/Ventura	Rector, Vestal	Aug NQC	Market
SCE	BIGCRK_2_EXESWD	24314	B CRK 4	11.5	43.37	41	BC/Ventura	Rector, Vestal	Aug NQC	Market
SCE	BIGCRK_2_EXESWD	24315	B CRK 8	13.8	37.86	82	BC/Ventura	Rector, Vestal	Aug NQC	Market
SCE	BIGCRK_2_EXESWD	24313	B CRK3-3	13.8	31.41	5	BC/Ventura	Rector, Vestal	Aug NQC	Market
SCE	BIGCRK_2_EXESWD	24312	B CRK3-2	13.8	30.98	4	BC/Ventura	Rector, Vestal	Aug NQC	Market
SCE	BIGCRK_2_EXESWD	24311	B CRK3-1	13.8	30.12	1	BC/Ventura	Rector, Vestal	Aug NQC	Market
SCE	BIGCRK_2_EXESWD	24312	B CRK3-2	13.8	30.12	3	BC/Ventura	Rector, Vestal	Aug NQC	Market
SCE	BIGCRK_2_EXESWD	24311	B CRK3-1	13.8	29.26	2	BC/Ventura	Rector, Vestal	Aug NQC	Market
SCE	BIGCRK_2_EXESWD	24307	B CRK1-2	13.8	26.85	4	BC/Ventura	Rector, Vestal	Aug NQC	Market
SCE	BIGCRK_2_EXESWD	24315	B CRK 8	13.8	21.00	81	BC/Ventura	Rector, Vestal	Aug NQC	Market
SCE	BIGCRK_2_EXESWD	24306	B CRK1-1	7.2	18.59	2	BC/Ventura	Rector, Vestal	Aug NQC	Market
SCE	BIGCRK_2_EXESWD	24307	B CRK1-2	13.8	18.59	3	BC/Ventura	Rector, Vestal	Aug NQC	Market
SCE	BIGCRK_2_EXESWD	24306	B CRK1-1	7.2	17.12	1	BC/Ventura	Rector, Vestal	Aug NQC	Market
SCE	BIGCRK_2_EXESWD	24309	B CRK2-2	7.2	16.95	4	BC/Ventura	Rector, Vestal	Aug NQC	Market
SCE	BIGCRK_2_EXESWD	24309	B CRK2-2	7.2	16.09	3	BC/Ventura	Rector, Vestal	Aug NQC	Market
SCE	BIGCRK_2_EXESWD	24310	B CRK2-3	7.2	15.92	6	BC/Ventura	Rector, Vestal	Aug NQC	Market
SCE	BIGCRK_2_EXESWD	24310	B CRK2-3	7.2	14.63	5	BC/Ventura	Rector, Vestal	Aug NQC	Market
SCE	BIGCRK_2_EXESWD	24323	PORTAL	4.8	8.26	1	BC/Ventura	Rector, Vestal	Aug NQC	Market
SCE	BIGCRK_7_DAM7				0.00		BC/Ventura	Rector, Vestal	Not modeled Energy Only	Market

Attachment A - List of physical resources by PTO, local area and market ID

SCE	BIGCRK_7_MAMRES				0.00		BC/Ventura	Rector, Vestal	Not modeled Energy Only	Market
SCE	BIGSKY_2_BSKSR6	29736	BSKY_G_BA	0.65	5.40	1	BC/Ventura		Aug NQC	Solar
SCE	BIGSKY_2_BSKSR7	29742	BSKY_G_BC	0.65	5.40	1	BC/Ventura		Aug NQC	Solar
SCE	BIGSKY_2_BSKSR8	29739	BSKY_G_BB	0.65	5.40	1	BC/Ventura		Aug NQC	Solar
SCE	BIGSKY_2_SOLAR1	29724	BSKY_G_ABS R	0.42	5.40	1	BC/Ventura		Aug NQC	Solar
SCE	BIGSKY_2_SOLAR2				34.34		BC/Ventura		Not modeled Aug NQC	Solar
SCE	BIGSKY_2_SOLAR3	29727	BSKY_G_SMR	0.42	5.40	1	BC/Ventura		Aug NQC	Solar
SCE	BIGSKY_2_SOLAR4	29701	BSKY_G_ES WA	0.42	17.41	1	BC/Ventura		Aug NQC	Solar
SCE	BIGSKY_2_SOLAR5	29733	BSKY_G_DR1 2	0.44	1.35	1	BC/Ventura		Aug NQC	Solar
SCE	BIGSKY_2_SOLAR6	29730	BSKY_G_SOL V	0.42	22.95	1	BC/Ventura		Aug NQC	Solar
SCE	BIGSKY_2_SOLAR7	29733	BSKY_G_DSR 12	0.44	13.50	1	BC/Ventura		Aug NQC	Solar
SCE	CEDUCR_2_SOLAR1	25049	DUCOR1	0.39	0.00	EQ	BC/Ventura	Vestal	Energy Only	Solar
SCE	CEDUCR_2_SOLAR2	25052	DUCOR2	0.39	0.00	EQ	BC/Ventura	Vestal	Energy Only	Solar
SCE	CEDUCR_2_SOLAR3	25055	DUCOR3	0.39	0.00	EQ	BC/Ventura	Vestal	Energy Only	Solar
SCE	CEDUCR_2_SOLAR4	25058	DUCOR4	0.39	0.00	EQ	BC/Ventura	Vestal	Energy Only	Solar
SCE	CHARMN_2_PGONG1	24340	CHARMIN	13.8	18.09	1	BC/Ventura	S.Clara, Moorpark		QF/Selfgen
SCE	DELSUR_6_BSOLAR	25802	DEL SUR FD2	12.5	0.81	EQ	BC/Ventura		Aug NQC	Solar
SCE	DELSUR_6_CREST				0.00		BC/Ventura		Not modeled Energy Only	Market
SCE	DELSUR_6_DRYFRB	25802	DEL SUR FD2	12.5	1.35	EQ	BC/Ventura		Aug NQC	Market
SCE	DELSUR_6_SOLAR1	25803	DEL SUR FD3	12.5	1.76	EQ	BC/Ventura		Aug NQC	Solar
SCE	DELSUR_6_SOLAR4				0.00		BC/Ventura		Not modeled Energy Only	Solar
SCE	DELSUR_6_SOLAR5				0.00		BC/Ventura		Not modeled Energy Only	Solar
SCE	EASTWD_7_UNIT	24319	EASTWOOD	13.8	199.00	1	BC/Ventura	Rector, Vestal		Market
SCE	EDMONS_2_NSPIN	25605	EDMON1AP	14.4	16.86	1	BC/Ventura		Pumps	MUNI
SCE	EDMONS_2_NSPIN	25606	EDMON2AP	14.4	16.86	2	BC/Ventura		Pumps	MUNI
SCE	EDMONS_2_NSPIN	25607	EDMON3AP	14.4	16.86	3	BC/Ventura		Pumps	MUNI
SCE	EDMONS_2_NSPIN	25607	EDMON3AP	14.4	16.86	4	BC/Ventura		Pumps	MUNI

Attachment A - List of physical resources by PTO, local area and market ID

SCE	EDMONS_2_NSPIN	25608	EDMON4AP	14.4	16.86	5	BC/Ventura		Pumps	MUNI
SCE	EDMONS_2_NSPIN	25608	EDMON4AP	14.4	16.86	6	BC/Ventura		Pumps	MUNI
SCE	EDMONS_2_NSPIN	25609	EDMON5AP	14.4	16.86	7	BC/Ventura		Pumps	MUNI
SCE	EDMONS_2_NSPIN	25609	EDMON5AP	14.4	16.86	8	BC/Ventura		Pumps	MUNI
SCE	EDMONS_2_NSPIN	25610	EDMON6AP	14.4	16.86	9	BC/Ventura		Pumps	MUNI
SCE	EDMONS_2_NSPIN	25610	EDMON6AP	14.4	16.86	10	BC/Ventura		Pumps	MUNI
SCE	EDMONS_2_NSPIN	25611	EDMON7AP	14.4	16.85	11	BC/Ventura		Pumps	MUNI
SCE	EDMONS_2_NSPIN	25611	EDMON7AP	14.4	16.85	12	BC/Ventura		Pumps	MUNI
SCE	EDMONS_2_NSPIN	25612	EDMON8AP	14.4	16.85	13	BC/Ventura		Pumps	MUNI
SCE	EDMONS_2_NSPIN	25612	EDMON8AP	14.4	16.85	14	BC/Ventura		Pumps	MUNI
SCE	GLDFGR_6_SOLAR1	25079	PRIDE B G	0.64	5.40	1	BC/Ventura		Aug NQC	Solar
SCE	GLDFGR_6_SOLAR2	25169	PRIDE C G	0.64	3.08	1	BC/Ventura		Aug NQC	Solar
SCE	GLOW_6_SOLAR	29896	APPINV	0.42	0.00	EQ	BC/Ventura		Energy Only	Solar
SCE	GOLETA_2_QF	25895	GOLETA EQFD	12.5	0.09	EQ	BC/Ventura	S.Clara, Moorpark, Goleta	Aug NQC	QF/Selfgen
SCE	GOLETA_2_VALBT1	25726	WDT1492_G	0.6	10.00	EQ	BC/Ventura	S.Clara, Moorpark, Goleta		Battery
SCE	GOLETA_6_ELLWOD	29004	ELLWOOD	13.8	0.00	1	BC/Ventura	S.Clara, Moorpark, Goleta		Market
SCE	GOLETA_6_EXGEN	24362	EXGEN2	13.8	0.00	G1	BC/Ventura	S.Clara, Moorpark, Goleta	Aug NQC - Currently out of service	QF/Selfgen
SCE	GOLETA_6_EXGEN	24326	EXGEN1	13.8	0.00	S1	BC/Ventura	S.Clara, Moorpark, Goleta	Aug NQC - Currently out of service	QF/Selfgen
SCE	LEBECS_2_UNITS	29053	PSTRIAS1	18	176.14	S1	BC/Ventura		Aug NQC	Market
SCE	LEBECS_2_UNITS	29051	PSTRIAG1	18	171.10	G1	BC/Ventura		Aug NQC	Market
SCE	LEBECS_2_UNITS	29052	PSTRIAG2	18	171.10	G2	BC/Ventura		Aug NQC	Market
SCE	LEBECS_2_UNITS	29054	PSTRIAG3	18	171.10	G3	BC/Ventura		Aug NQC	Market
SCE	LEBECS_2_UNITS	29055	PSTRIAS2	18	85.55	S2	BC/Ventura		Aug NQC	Market
SCE	LITLRK_6_GBCSR1	25798	OASIS FD	12.5	0.81	EQ	BC/Ventura		Aug NQC	Solar
SCE	LITLRK_6_SEPV01				0.00		BC/Ventura		Not modeled Energy Only	Market
SCE	LITLRK_6_SOLAR1	25840	LITLRCK FD	12.5	1.35	EQ	BC/Ventura		Aug NQC	Solar
SCE	LITLRK_6_SOLAR2	25840	LITLRCK FD	12.5	0.54	EQ	BC/Ventura		Aug NQC	Solar
SCE	LITLRK_6_SOLAR3	25840	LITLRCK FD	12.5	0.54	EQ	BC/Ventura		Aug NQC	Solar
SCE	LITLRK_6_SOLAR4	25840	LITLRCK FD	12.5	0.81	EQ	BC/Ventura		Aug NQC	Solar

Attachment A - List of physical resources by PTO, local area and market ID

SCE	LNCSTR_6_CREST				0.00		BC/Ventura		Not modeled Energy Only	Market
SCE	LNCSTR_6_SOLAR2	25796	LANCSTR FD1	12.5	2.75	EQ	BC/Ventura		Aug NQC	Solar
SCE	MNDALY_6_MCGRTH	29306	MCGPKGEN	13.8	47.20	1	BC/Ventura	S.Clara, Moorpark		Market
SCE	MOORPK_2_ACOBT1				1.00		BC/Ventura	Moorpark	Not modeled	Battery
SCE	MOORPK_2_CALABS	25081	WDT251	13.8	4.32	EQ	BC/Ventura	Moorpark	Aug NQC	Market
SCE	MOORPK_6_QF				0.50		BC/Ventura	Moorpark	Not modeled Aug NQC	Market
SCE	NEENCH_6_SOLAR	29900	ALPINE_G	0.48	17.82	EQ	BC/Ventura		Aug NQC	Solar
SCE	OASIS_6_CREST				0.00		BC/Ventura		Not modeled Energy Only	Market
SCE	OASIS_6_GBDSR4	25800	ANTLOPE EQFD	12.5	0.81	EQ	BC/Ventura		Aug NQC	Solar
SCE	OASIS_6_SOLAR1	25095	SOLARISG2	0.2	0.00	EQ	BC/Ventura		Energy Only	Solar
SCE	OASIS_6_SOLAR2	25075	SOLARISG	0.2	5.40	EQ	BC/Ventura		Aug NQC	Solar
SCE	OASIS_6_SOLAR3				0.00		BC/Ventura		Not modeled Energy Only	Solar
SCE	OMAR_2_UNIT 1	24102	OMAR 1G	13.8	72.67	1	BC/Ventura			Net Seller
SCE	OMAR_2_UNIT 2	24103	OMAR 2G	13.8	73.00	2	BC/Ventura			Net Seller
SCE	OMAR_2_UNIT 3	24104	OMAR 3G	13.8	73.00	3	BC/Ventura			Net Seller
SCE	OMAR_2_UNIT 4	24105	OMAR 4G	13.8	73.67	4	BC/Ventura			Net Seller
SCE	ORMOND_7_UNIT 1	24107	ORMOND1G	26	0.00	1	BC/Ventura	Moorpark	Retired by 2024	Market
SCE	ORMOND_7_UNIT 2	24108	ORMOND2G	26	0.00	2	BC/Ventura	Moorpark	Retired by 2024	Market
SCE	OSO_6_NSPIN	25614	OSO A P	13.2	2.25	1	BC/Ventura		Pumps	MUNI
SCE	OSO_6_NSPIN	25614	OSO A P	13.2	2.25	2	BC/Ventura		Pumps	MUNI
SCE	OSO_6_NSPIN	25614	OSO A P	13.2	2.25	3	BC/Ventura		Pumps	MUNI
SCE	OSO_6_NSPIN	25614	OSO A P	13.2	2.25	4	BC/Ventura		Pumps	MUNI
SCE	OSO_6_NSPIN	25615	OSO B P	13.2	2.25	5	BC/Ventura		Pumps	MUNI
SCE	OSO_6_NSPIN	25615	OSO B P	13.2	2.25	6	BC/Ventura		Pumps	MUNI
SCE	OSO_6_NSPIN	25615	OSO B P	13.2	2.25	7	BC/Ventura		Pumps	MUNI
SCE	OSO_6_NSPIN	25615	OSO B P	13.2	2.25	8	BC/Ventura		Pumps	MUNI
SCE	PIUTE_6_GNBSR1	25840	LITLRCK FD	12.5	0.81	EQ	BC/Ventura		Aug NQC	Solar
SCE	PLAINV_6_BSOLAR	29917	SSOLAR_GR WKS	0.8	0.00	1	BC/Ventura		Energy Only	Solar

Attachment A - List of physical resources by PTO, local area and market ID

SCE	PLAINV_6_DSOLAR	29914	WADR_PV	0.42	2.70	1	BC/Ventura		Aug NQC	Solar
SCE	PLAINV_6_NLRSR1	29921	NLR_INVTR	0.42	0.00	1	BC/Ventura		Energy Only	Solar
SCE	PLAINV_6_SOLAR3	25089	CNTRL ANT G	0.42	0.00	1	BC/Ventura		Energy Only	Solar
SCE	PLAINV_6_SOLARC	25086	SIRA SOLAR G	0.8	0.00	1	BC/Ventura		Energy Only	Solar
SCE	PMDLET_6_SOLAR1	29926	WDT404_G	0.8	2.70	EQ	BC/Ventura		AugNQC	Solar
SCE	RECTOR_2_CREST				0.00		BC/Ventura	Rector, Vestal	Not modeled Aug NQC	Market
SCE	RECTOR_2_KAWEAH	25756	KAWEAH3G	2.4	0.83	1	BC/Ventura	Rector, Vestal	Aug NQC	Market
SCE	RECTOR_2_KAWEAH	25755	KAWEAH1G	2.4	0.42	1	BC/Ventura	Rector, Vestal	Aug NQC	Market
SCE	RECTOR_2_KAWEAH	25754	KAWEAH2G	2.4	0.42	2	BC/Ventura	Rector, Vestal	Aug NQC	Market
SCE	RECTOR_2_KAWH 1	24370	KAWGEN	13.8	0.00	1	BC/Ventura	Rector, Vestal	Aug NQC	Market
SCE	RECTOR_2_QF	25855	RECTOR EQFD	12.5	0.00	EQ	BC/Ventura	Rector, Vestal	Aug NQC	Net Seller
SCE	RECTOR_2_TFDBM1				0.00		BC/Ventura	Rector, Vestal	Not modeled Energy Only	Market
SCE	RECTOR_7_TULARE				0.00		BC/Ventura	Rector, Vestal	Not modeled Aug NQC	Market
SCE	REDMAN_2_SOLAR	25800	ANTLOPE EQFD	12.5	1.01	EQ	BC/Ventura		Aug NQC	Solar
SCE	REDMAN_6_AVSSR1	25800	ANTLOPE EQFD	12.5	0.81	EQ	BC/Ventura		Aug NQC	Solar
SCE	ROSMND_6_SOLAR	25800	ANTLOPE EQFD	12.5	0.81	EQ	BC/Ventura		Aug NQC	Solar
SCE	RSMSLR_6_SOLAR1	29984	DAWNGEN	0.8	5.40	EQ	BC/Ventura		Aug NQC	Solar
SCE	RSMSLR_6_SOLAR2	29888	TWILGHTG	0.8	5.40	EQ	BC/Ventura		Aug NQC	Solar
SCE	SAUGUS_6_CREST				0.00		BC/Ventura		Not modeled Energy Only	Market
SCE	SAUGUS_6_MWDFTH	25721	FOOTHILL	66	4.00	EQ	BC/Ventura		Aug NQC	MUNI
SCE	SAUGUS_6_QF	25891	Saugus EQFD	12.5	0.15	EQ	BC/Ventura		Aug NQC	QF/Selfgen
SCE	SAUGUS_6_QF	25865	SUAGUS EQFD	12.5	0.15	EQ	BC/Ventura		Aug NQC	QF/Selfgen
SCE	SAUGUS_7_CHIQCN	25722	LANDFILL	66	5.45	EQ	BC/Ventura		Aug NQC	Market
SCE	SHUTLE_6_CREST				0.00		BC/Ventura		Not modeled Energy Only	Market
SCE	SNCLRA_2_HOWLNG				4.71		BC/Ventura	S.Clara, Moorpark	Not modeled Aug NQC	Market
SCE	SNCLRA_2_SILBT1	25899	WDT1520_G	0.48	11.00	EQ	BC/Ventura	S.Clara, Moorpark		Battery

Attachment A - List of physical resources by PTO, local area and market ID

SCE	SNCLRA_2_SPRHYD				0.16		BC/Ventura	S.Clara, Moorpark	Not modeled Aug NQC	Market
SCE	SNCLRA_2_UNIT	29952	CAMGEN	13.8	27.50	D1	BC/Ventura	S.Clara, Moorpark		Market
SCE	SNCLRA_2_UNIT1	24159	WILLAMET	3.8	13.91	D1	BC/Ventura	S.Clara, Moorpark	Aug NQC	Market
SCE	SNCLRA_2_VESBT1	29824	WDT1519	66	100.00	1	BC/Ventura	S.Clara, Moorpark		Battery
SCE	SNCLRA_6_OXGEN	24110	OXGEN	13.8	47.70	D1	BC/Ventura	S.Clara, Moorpark		QF/Selfgen
SCE	SNCLRA_6_PROCGN	24119	PROCGEN	13.8	22.00	D1	BC/Ventura	S.Clara, Moorpark	Aug NQC	QF/Selfgen
SCE	SNCLRA_6_QF				0.00		BC/Ventura	S.Clara, Moorpark	Not modeled Aug NQC	QF/Selfgen
SCE	SPRGVL_2_CREST				0.00		BC/Ventura	Rector, Vestal	Not modeled Energy Only	Market
SCE	SPRGVL_2_QF	25867	SPRNGVL	12.5	0.18	EQ	BC/Ventura	Rector, Vestal	Aug NQC	QF/Selfgen
SCE	SPRGVL_2_TULESC	25714	TULE	66	0.00	EQ	BC/Ventura	Rector, Vestal	Aug NQC	Market
SCE	SUNSHN_2_LNDFL	29954	SUNSHINE	13.7	3.40	1	BC/Ventura		Aug NQC	Market
SCE	SUNSHN_2_LNDFL	29954	SUNSHINE	13.7	3.40	2	BC/Ventura		Aug NQC	Market
SCE	SUNSHN_2_LNDFL	29954	SUNSHINE	13.7	3.40	3	BC/Ventura		Aug NQC	Market
SCE	SUNSHN_2_LNDFL	29954	SUNSHINE	13.7	3.40	4	BC/Ventura		Aug NQC	Market
SCE	SUNSHN_2_LNDFL	29954	SUNSHINE	13.7	3.40	5	BC/Ventura		Aug NQC	Market
SCE	SYCAMR_2_UNIT 1	24143	SYCCYN1G	13.8	76.33	1	BC/Ventura		Aug NQC	Net Seller
SCE	SYCAMR_2_UNIT 2	24144	SYCCYN2G	13.8	73.33	2	BC/Ventura		Aug NQC	Net Seller
SCE	SYCAMR_2_UNIT 3	24145	SYCCYN3G	13.8	73.00	3	BC/Ventura		Aug NQC	Net Seller
SCE	SYCAMR_2_UNIT 4	24146	SYCCYN4G	13.8	73.00	4	BC/Ventura		Aug NQC	Net Seller
SCE	TENGEN_2_PL1X2	24148	TENNGEN1	13.8	17.16	D1	BC/Ventura		Aug NQC	Net Seller
SCE	TENGEN_2_PL1X2	24149	TENNGEN2	13.8	17.16	D2	BC/Ventura		Aug NQC	Net Seller
SCE	TULARE_2_TULBM1				0.00		BC/Ventura		Not modeled Energy Only	Market
SCE	VESTAL_2_KERN	24372	KR 3-1	11	6.12	1	BC/Ventura	Vestal	Aug NQC	QF/Selfgen
SCE	VESTAL_2_KERN	24373	KR 3-2	11	5.77	2	BC/Ventura	Vestal	Aug NQC	QF/Selfgen
SCE	VESTAL_2_RTS042	25874	VESTAL E	12,4 7	0.00	EQ	BC/Ventura	Vestal	Energy Only	Market
SCE	VESTAL_2_SOLAR1	25064	TULRESLR_1 G	0.39	5.40	EQ	BC/Ventura	Vestal	Aug NQC	Solar
SCE	VESTAL_2_SOLAR2	25065	TULRESLR_2 G	0.39	3.78	EQ	BC/Ventura	Vestal	Aug NQC	Solar
SCE	VESTAL_2_UNIT1	25893	VESTAL E	12.5	3.49	EQ	BC/Ventura	Vestal	Aug NQC	Market
SCE	VESTAL_2_WELLHD	24116	WELLGEN	13.8	49.00	1	BC/Ventura	Vestal		Market
SCE	VESTAL_6_QF	29008	LAKEGEN	13.8	8.65	1	BC/Ventura	Vestal	Aug NQC	Market

Attachment A - List of physical resources by PTO, local area and market ID

SCE	WARNE_2_UNIT	25651	WARNE1	13.8	20.72	1	BC/Ventura		Aug NQC	MUNI
SCE	WARNE_2_UNIT	25652	WARNE2	13.8	20.72	2	BC/Ventura		Aug NQC	MUNI
SCE	ZZZ_New Unit	29792	ANTLP2_BE_B1	0.48	208.80	EQ	BC/Ventura		No NQC - est. data	Battery
SCE	ZZZ_New Unit	29782	ANTLP2_C2_G1	0.44	68.53	EQ	BC/Ventura		No NQC - est. data	Solar
SCE	ZZZ_New Unit	29345	TOT833_B1	0.55	55.00	B1	BC/Ventura		No NQC - Pmax	Battery
SCE	ZZZ_New Unit	25959	TOT896_G1P_V	0.55	40.50	1	BC/Ventura	Vestal	No NQC - est. data	Solar
SCE	ZZZ_New Unit	25965	TOT896_G2P_V	0.55	40.50	1	BC/Ventura	Vestal	No NQC - est. data	Solar
SCE	ZZZ_New Unit	29826	WDT1454	66	40.00	1	BC/Ventura	S.Clara, Moorpark	No NQC - Pmax	Battery
SCE	ZZZ_New Unit	29346	TOT833_B2	0.55	27.50	B2	BC/Ventura		No NQC - Pmax	Battery
SCE	ZZZ_New Unit	29830	WDT1454	66	20.00	1	BC/Ventura	S.Clara, Moorpark	No NQC - Pmax	Battery
SCE	ZZZ_New Unit	25069	WDT1490_PV	0.36	15.12	1	BC/Ventura	Vestal	No NQC - est. data	Solar
SCE	ZZZ_New Unit	25789	WDT1384_G	0.39	13.50	1	BC/Ventura	Vestal	No NQC - est. data	Solar
SCE	ZZZ_New Unit	29771	ANT2_SPB	0.6	13.15	EQ	BC/Ventura		No NQC - est. data	Solar
SCE	ZZZ_New Unit	25758	WDT1535_G	0.69	10.00	1	BC/Ventura	S.Clara, Moorpark, Goleta	No NQC - Pmax	Battery
SCE	ZZZ_New Unit	25795	WDT1539_G	0.8	10.00	1	BC/Ventura	S.Clara, Moorpark, Goleta	No NQC - Pmax	Battery
SCE	ZZZ_New Unit	25539	WDT1486_G	0.6	10.00	EQ	BC/Ventura	S.Clara, Moorpark, Goleta	No NQC - Pmax	Battery
SCE	ZZZ_New Unit	29344	TOT833_PV2	0.55	10.00	S2	BC/Ventura		No NQC - est. data	Solar
SCE	ZZZ_New Unit	29347	WDT1517_G1	0.36	5.01	1	BC/Ventura		No NQC - est. data	Solar
SCE	ZZZ_New Unit	29343	TOT833_PV1	0.55	5.00	S1	BC/Ventura		No NQC - est. data	Solar
SCE	ZZZ_New Unit	29775	ANTLP2_P7_G1	0.44	4.59	EQ	BC/Ventura		No NQC - est. data	Solar
SCE	ZZZ_New Unit	25790	WDT1384_G-ST	0.39	0.00	1	BC/Ventura	Vestal	Energy Only	Battery

Attachment A - List of physical resources by PTO, local area and market ID

SCE	ZZZZ_New Unit	25967	TOT896_G2S T	0.55	109.50	1	BC/Ventura	Vestal	No NQC - Pmax	Battery
SCE	ZZZZ_New Unit	25961	TOT896_G1S T	0.55	109.50	1	BC/Ventura	Vestal	No NQC - Pmax	Battery
SCE	ZZZZA_New Unit	102296	RP_MOR_BE SS_	0.66	250.00	VE	BC/Ventura	Moorpark	No NQC - est. data	Battery
SCE	ZZZZA_New Unit	102299	RP_MOR_BE SS_	0.66	250.00	VE	BC/Ventura	Moorpark	No NQC - est. data	Battery
SCE	ZZZZA_New Unit	29767	ANTLP2_P7B_ G	0.69	133.90	1	BC/Ventura		No NQC - est. data	Battery
SCE	ZZZZA_New Unit	29561	ANTLP2_P1_ G1	0.63	125.80	1	BC/Ventura		No NQC - est. data	Battery
SCE	ZZZZA_New Unit	102418	RP_VEST_PV _G	0.38	81.00	VE	BC/Ventura	Vestal	No NQC - est. data	Battery
SCE	ZZZZA_New Unit	102431	RP_PSTR_G	0.66	80.00	VE	BC/Ventura		No NQC - est. data	Battery
SCE	ZZZZA_New Unit	102303	RP_ANT_PV_ G	0.38	37.20	VS	BC/Ventura		No NQC - est. data	Solar
SCE	ZZZZA_New Unit	102287	RP_ANT_BES S_	0.66	24.10	VE	BC/Ventura		No NQC - est. data	Battery
SCE	ZZZZA_New Unit	102300	RP_ANT_PV_ G	0.38	17.78	VS	BC/Ventura		No NQC - est. data	Solar
SCE	ZZZZA_New Unit	102401	RP_SC_BEES _G	0.66	10.00	VE	BC/Ventura	S.Clara, Moorpark	No NQC - est. data	Battery
SCE	ZZZZA_New Unit	102427	BIGCRK_BIO	13.8	6.00	VB	BC/Ventura	Rector, Vestal	No NQC - est. data	Market
SCE	ZZZZA_New Unit	102428	SPRNVL_BIO	13.8	4.00	VB	BC/Ventura	Rector, Vestal	No NQC - est. data	Market
SCE	ZZZZA_New Unit	29565	ANTLP2_P10_ G2	0.69	0.45	2	BC/Ventura		No NQC - est. data	Solar
SCE	ZZZZA_New Unit	29563	ANTLP2_P9_ G2	0.69	0.37	2	BC/Ventura		No NQC - est. data	Solar
SCE	ZZZZA_New Unit	29569	ANTLP2_P5_ G	0.66	0.00	1	BC/Ventura		No NQC - est. data	Solar
SCE	ZZZZA_New Unit	29566	ANTLP2_P1B G2	0.69	0.00	1	BC/Ventura		No NQC - est. data	Solar
SCE	ZZZZA_New Unit	29774	ANTLP2_P4_ G	0.63	0.00	1	BC/Ventura		No NQC - est. data	Solar
SCE	ZZZZA_New Unit	29775	ANTLP2_P8_ G1	0.66	0.00	1	BC/Ventura		No NQC - est. data	Solar



Attachment A - List of physical resources by PTO, local area and market ID

SCE	ZZZZA_New Unit	29782	ANTLP2_P10_G1	0.66	0.00	1	BC/Ventura		No NQC - est. data	Solar
SCE	ZZZZA_New Unit	29792	ANTLP2_P6A_G	0.69	0.00	1	BC/Ventura		No NQC - est. data	Solar
SCE	ZZZZA_New Unit	102306	RP_ANT_PV_G	0.38	0.00	VS	BC/Ventura		No NQC - est. data	Solar
SCE	ZZZZA_New Unit	102312	RP_MOR_PV_G	0.38	0.00	VS	BC/Ventura	Moorpark	No NQC - est. data	Solar
SCE	ZZZZA_New Unit	102315	RP_MOR_PV_G	0.38	0.00	VS	BC/Ventura	Moorpark	No NQC - est. data	Solar
SCE	ZZZZA_New Unit	102415	RP_PSTR_PV_G	0.38	0.00	VS	BC/Ventura		No NQC - est. data	Solar
SCE	ZZZZA_New Unit	102418	RP_VEST_PV_G	0.38	0.00	VS	BC/Ventura	Vestal	No NQC - est. data	Solar
SCE	ZZZZZ_APPGEN_6_UNIT 1	24009	APPGEN1G	13.8	0.00	1	BC/Ventura		Retired	Market
SCE	ZZZZZ_APPGEN_6_UNIT 1	24010	APPGEN2G	13.8	0.00	2	BC/Ventura		Retired	Market
SCE	ZZZZZ_APPGEN_6_UNIT 1	24361	APPGEN3G	13.8	0.00	3	BC/Ventura		Retired	Market
SCE	ZZZZZ_GOLETA_6_GAVO TA	25335	GOLETA_DIS T	66	0.00	S1	BC/Ventura	S.Clara, Moorpark, Goleta	Retired	Market
SCE	ZZZZZ_GOLETA_6_TAJIG S	25335	GOLETA_DIS T	66	0.00	S1	BC/Ventura	S.Clara, Moorpark, Goleta	Retired	Market
SCE	ZZZZZ_MNDALY_7_UNIT 1	24089	MANDLY1G	13.8	0.00	1	BC/Ventura	S.Clara, Moorpark	Retired	Market
SCE	ZZZZZ_MNDALY_7_UNIT 2	24090	MANDLY2G	13.8	0.00	2	BC/Ventura	S.Clara, Moorpark	Retired	Market
SCE	ZZZZZ_MNDALY_7_UNIT 3	24222	MANDLY3G	16	0.00	3	BC/Ventura	S.Clara, Moorpark	Retired	Market
SCE	ZZZZZ_MOORPK_7_UNIT A1	24098	MOORPARK	66	0.00		BC/Ventura	Moorpark	Retired	Market
SCE	ZZZZZ_PANDOL_6_UNIT	24113	PANDOL	13.8	0.00	1	BC/Ventura	Vestal	Retired	Market
SCE	ZZZZZ_PANDOL_6_UNIT	24113	PANDOL	13.8	0.00	2	BC/Ventura	Vestal	Retired	Market
SCE	ZZZZZ_SAUGUS_2_TOLA ND	24135	SAUGUS	66	0.00		BC/Ventura		Retired	Market
SCE	ZZZZZ_SAUGUS_6_PTCH GN	24118	PITCHGEN	13.8	0.00	D1	BC/Ventura		Retired	MUNI
SCE	ZZZZZ_SAUGUS_7_LOPE Z	24135	SAUGUS	66	0.00		BC/Ventura		Retired	QF/Selfgen

Attachment A - List of physical resources by PTO, local area and market ID

SCE	ZZZZ_SPRGVL_2_TULE	25334	SPRNGVL_DI ST	66	0.00	S2	BC/Ventura	Rector, Vestal	Retired	Market
SCE	ZZZZ_VESTAL_6_ULTR GN	24150	ULTRAGEN	13.8	0.00	1	BC/Ventura	Vestal	Retired	QF/Selfgen
SCE	ALAMIT_2_PL1X3	24577	ALMT STG	18	251.66	S1	LA Basin	Western		Market
SCE	ALAMIT_2_PL1X3	24575	ALMT CTG1	18	211.52	G1	LA Basin	Western		Market
SCE	ALAMIT_2_PL1X3	24576	ALMT CTG2	18	211.52	G2	LA Basin	Western		Market
SCE	ALAMIT_7_ES1	698082	ALMITOS B1A	0.42	50.00	1	LA Basin	Western		Battery
SCE	ALAMIT_7_ES1	698083	ALMITOS B12	0.42	50.00	1	LA Basin	Western		Battery
SCE	ALAMIT_7_UNIT 3	24003	ALAMT3 G	18	0.00	3	LA Basin	Western	Retired by 2024	Market
SCE	ALAMIT_7_UNIT 4	24004	ALAMT4 G	18	0.00	4	LA Basin	Western	Retired by 2024	Market
SCE	ALAMIT_7_UNIT 5	24005	ALAMT5 G	20	0.00	5	LA Basin	Western	Retired by 2024	Market
SCE	ALTWD_2_AT3WD3	29077	ALTWNDGEN 2	0.6	2.06	1	LA Basin	Eastern, Valley- Devers	Aug NQC	Wind
SCE	ALTWD_2_COAWD1	29075	ALTWNDGEN 1	0.65	10.58	1	LA Basin	Eastern, Valley- Devers	Aug NQC	Wind
SCE	ANAHM_2_CANYN1	25211	CanyonGT 1	13.8	49.40	1	LA Basin	Western		MUNI
SCE	ANAHM_2_CANYN2	25212	CanyonGT 2	13.8	48.00	2	LA Basin	Western		MUNI
SCE	ANAHM_2_CANYN3	25213	CanyonGT 3	13.8	48.00	3	LA Basin	Western		MUNI
SCE	ANAHM_2_CANYN4	25214	CanyonGT 4	13.8	49.40	4	LA Basin	Western		MUNI
SCE	ARCOGN_2_UNITS	24011	ARCO 1G	13.8	61.00	1	LA Basin	Western	Aug NQC	Net Seller
SCE	ARCOGN_2_UNITS	24012	ARCO 2G	13.8	61.00	2	LA Basin	Western	Aug NQC	Net Seller
SCE	ARCOGN_2_UNITS	24013	ARCO 3G	13.8	61.00	3	LA Basin	Western	Aug NQC	Net Seller
SCE	ARCOGN_2_UNITS	24014	ARCO 4G	13.8	61.00	4	LA Basin	Western	Aug NQC	Net Seller
SCE	ARCOGN_2_UNITS	24163	ARCO 5G	13.8	30.50	5	LA Basin	Western	Aug NQC	Net Seller
SCE	ARCOGN_2_UNITS	24164	ARCO 6G	13.8	30.50	6	LA Basin	Western	Aug NQC	Net Seller
SCE	BARRE_2_QF	24016	BARRE	230	0.00		LA Basin	Western	Not modeled	QF/Selfgen
SCE	BARRE_6_PEAKER	29309	BARPKGEN	13.8	47.00	1	LA Basin	Western		Market
SCE	BLAST_1_WIND	24839	BLAST	115	10.29	1	LA Basin	Eastern, Valley- Devers	Aug NQC	Wind
SCE	BUCKWD_1_NPALM1	25634	BUCKWIND	115	0.65		LA Basin	Eastern, Valley- Devers	Not modeled Aug NQC	Wind
SCE	BUCKWD_1_QF	25634	BUCKWIND	115	3.47	QF	LA Basin	Eastern, Valley- Devers	Aug NQC	QF/Selfgen

Attachment A - List of physical resources by PTO, local area and market ID

SCE	BUCKWD_7_WINTCV	25634	BUCKWIND	115	0.28	W5	LA Basin	Eastern, Valley-Devers	Aug NQC	Wind
SCE	CABZON_1_WINDA1	29290	CABAZON	33	8.61	1	LA Basin	Eastern, Valley-Devers	Aug NQC	Wind
SCE	CAPWD_1_QF	25633	CAPWIND	115	4.11	QF	LA Basin	Eastern, Valley-Devers	Aug NQC	QF/Selfgen
SCE	CENTER_2_RHONDO	25810	CENTER EQFD	12.5	1.91	EQ	LA Basin	Western		QF/Selfgen
SCE	CENTER_2_SOLAR1				0.00		LA Basin	Western	Not modeled Energy Only	Solar
SCE	CENTER_2_TECNG1				0.00		LA Basin	Western	Not modeled Energy Only	Market
SCE	CENTER_6_PEAKER	29308	CTRPKGEN	13.8	47.11	1	LA Basin	Western		Market
SCE	CENTRY_6_PL1X4	25302	CLTNCTRY	13.8	36.00	1	LA Basin	Eastern	Aug NQC	MUNI
SCE	CHEVMN_2_UNITS	24022	CHEVGEN1	13.8	1.41	1	LA Basin	Western, El Nido	Aug NQC	Net Seller
SCE	CHEVMN_2_UNITS	24023	CHEVGEN2	13.8	1.41	2	LA Basin	Western, El Nido	Aug NQC	Net Seller
SCE	CHINO_2_APEBT1	25180	WDT1250BES S_	0.48	20.00	1	LA Basin	Eastern	Aug NQC	Battery
SCE	CHINO_2_JURUPA				0.00		LA Basin	Eastern	Not modeled Energy Only	Market
SCE	CHINO_2_QF				0.00		LA Basin	Eastern	Not modeled Aug NQC	QF/Selfgen
SCE	CHINO_2_SASOLR				0.00		LA Basin	Eastern	Not modeled Energy Only	Solar
SCE	CHINO_2_SOLAR				0.27		LA Basin	Eastern	Not modeled	Solar
SCE	CHINO_2_SOLAR2				0.00		LA Basin	Eastern	Not modeled Energy Only	Solar
SCE	CHINO_6_CIMGEN	24026	CIMGEN	13.8	26.00	D1	LA Basin	Eastern	Aug NQC	QF/Selfgen
SCE	CHINO_7_MILIKN	24024	CHINO	66	1.19		LA Basin	Eastern	Not modeled Aug NQC	Market
SCE	COLTON_6_AGUAM1	25303	CLTNAGUA	13.8	43.00	1	LA Basin	Eastern	Aug NQC	MUNI
SCE	CORONS_2_SOLAR				0.00		LA Basin	Eastern	Not modeled Energy Only	Solar
SCE	CORONS_6_CLRWTR	29338	CLRWTRCT	13.8	20.72	G1	LA Basin	Eastern		MUNI
SCE	CORONS_6_CLRWTR	29340	CLRWTRST	13.8	7.28	S1	LA Basin	Eastern		MUNI
SCE	DELAMO_2_SOLAR1	25818	DELAMO EQFD	12.5	0.41	EQ	LA Basin	Western	Aug NQC	Solar
SCE	DELAMO_2_SOLAR2	25818	DELAMO EQFD	12.5	0.47	EQ	LA Basin	Western	Aug NQC	Solar

Attachment A - List of physical resources by PTO, local area and market ID

SCE	DELAMO_2_SOLAR3	25818	DELAMO EQFD	12.5	0.34	EQ	LA Basin	Western	Aug NQC	Solar
SCE	DELAMO_2_SOLAR4	25818	DELAMO EQFD	12.5	0.35	EQ	LA Basin	Western	Aug NQC	Solar
SCE	DELAMO_2_SOLAR5	25818	DELAMO EQFD	12.5	0.27	EQ	LA Basin	Western	Aug NQC	Solar
SCE	DELAMO_2_SOLAR6	25818	DELAMO EQFD	12.5	0.54	EQ	LA Basin	Western	Aug NQC	Solar
SCE	DELAMO_2_SOLRC1				0.00		LA Basin	Western	Not modeled Energy Only	Solar
SCE	DELAMO_2_SOLRD				0.00		LA Basin	Western	Not modeled Energy Only	Solar
SCE	DEVERS_1_QF	25632	TERAWND	115	0.00	QF	LA Basin	Eastern, Valley-Devers	Mothballed	QF/Selfgen
SCE	DEVERS_1_QF	25639	SEAWIND	115	0.00	QF	LA Basin	Eastern, Valley-Devers	Mothballed	QF/Selfgen
SCE	DEVERS_1_SEPV05				0.00		LA Basin	Eastern, Valley-Devers	Not modeled Energy Only	Market
SCE	DEVERS_1_SOLAR				0.00		LA Basin	Eastern, Valley-Devers	Not modeled Energy Only	Solar
SCE	DEVERS_1_SOLAR1				0.00		LA Basin	Eastern, Valley-Devers	Not modeled Energy Only	Solar
SCE	DEVERS_1_SOLAR2				0.00		LA Basin	Eastern, Valley-Devers	Not modeled Energy Only	Solar
SCE	DEVERS_2_CS2SR4				0.00		LA Basin	Eastern, Valley-Devers	Not modeled Energy Only	Solar
SCE	DEVERS_2_DHSPG2				0.00		LA Basin	Eastern, Valley-Devers	Not modeled Energy Only	Market
SCE	DMDVLY_1_UNITS	25425	ESRP P2	6.9	3.09	8	LA Basin	Eastern	Aug NQC	QF/Selfgen
SCE	DREWS_6_PL1X4	25301	CLTNDREW	13.8	36.00	1	LA Basin	Eastern	Aug NQC	MUNI
SCE	DVLCYN_1_UNITS	25603	DVLCYN3G	13.8	26.55	3	LA Basin	Eastern	Aug NQC	MUNI
SCE	DVLCYN_1_UNITS	25604	DVLCYN4G	13.8	26.55	4	LA Basin	Eastern	Aug NQC	MUNI
SCE	DVLCYN_1_UNITS	25648	DVLCYN1G	13.8	19.91	1	LA Basin	Eastern	Aug NQC	MUNI
SCE	DVLCYN_1_UNITS	25649	DVLCYN2G	13.8	19.91	2	LA Basin	Eastern	Aug NQC	MUNI
SCE	ELLIS_2_QF	24325	ORCOGEN	13.8	0.34	1	LA Basin	Western	Aug NQC	QF/Selfgen
SCE	ELSEGN_2_UN1011	29904	ELSEG5GT	16.5	137.16	5	LA Basin	Western, El Nido	Aug NQC	Market
SCE	ELSEGN_2_UN1011	29903	ELSEG6ST	13.8	137.16	6	LA Basin	Western, El Nido	Aug NQC	Market
SCE	ELSEGN_2_UN2021	29902	ELSEG7GT	16.5	135.87	7	LA Basin	Western, El Nido	Aug NQC	Market

Attachment A - List of physical resources by PTO, local area and market ID

SCE	ELSEGN_2_UN2021	29901	ELSEG8ST	13.8	135.87	8	LA Basin	Western, El Nido	Aug NQC	Market
SCE	ESNHWR_2_WC1BT1	25632	WDT1549	12.5	1.50	EQ	LA Basin	Eastern, Valley-Devers		Battery
SCE	ETIWND_2_CHMPNE				0.00		LA Basin	Eastern	Not modeled Energy Only	Market
SCE	ETIWND_2_FONTNA	24055	ETIWANDA	66	0.65		LA Basin	Eastern	Not modeled Aug NQC	QF/Selfgen
SCE	ETIWND_2_RTS010	24055	ETIWANDA	66	0.41		LA Basin	Eastern	Not modeled Aug NQC	Market
SCE	ETIWND_2_RTS015	24055	ETIWANDA	66	0.81		LA Basin	Eastern	Not modeled Aug NQC	Market
SCE	ETIWND_2_RTS017	24055	ETIWANDA	66	0.95		LA Basin	Eastern	Not modeled Aug NQC	Market
SCE	ETIWND_2_RTS018	24055	ETIWANDA	66	0.41		LA Basin	Eastern	Not modeled Aug NQC	Market
SCE	ETIWND_2_RTS023	24055	ETIWANDA	66	0.68		LA Basin	Eastern	Not modeled Aug NQC	Market
SCE	ETIWND_2_RTS026	24055	ETIWANDA	66	1.62		LA Basin	Eastern	Not modeled Aug NQC	Market
SCE	ETIWND_2_RTS027	24055	ETIWANDA	66	0.54		LA Basin	Eastern	Not modeled Aug NQC	Market
SCE	ETIWND_2_SOLAR1				0.27		LA Basin	Eastern	Not modeled Energy Only	Solar
SCE	ETIWND_2_SOLAR2				0.00		LA Basin	Eastern	Not modeled Energy Only	Solar
SCE	ETIWND_2_SOLAR5				0.00		LA Basin	Eastern	Not modeled Energy Only	Solar
SCE	ETIWND_2_UNIT1	24071	INLAND	13.8	4.27	1	LA Basin	Eastern	Aug NQC	QF/Selfgen
SCE	ETIWND_6_GRPLND	29305	ETWPKGEN	13.8	47.39	1	LA Basin	Eastern		Market
SCE	ETIWND_6_MWDETI	25422	ETI MW DG	13.8	0.00	1	LA Basin	Eastern	Aug NQC	Market
SCE	GARNET_1_SOLAR	24815	GARNET	115	0.00		LA Basin	Eastern, Valley-Devers	Not modeled Energy Only	Solar
SCE	GARNET_1_SOLAR2	24815	GARNET	115	1.08		LA Basin	Eastern, Valley-Devers	Not modeled Aug NQC	Solar
SCE	GARNET_1_UNITS	24815	GARNET	115	1.63	G1	LA Basin	Eastern, Valley-Devers	Aug NQC	Market
SCE	GARNET_1_UNITS	24815	GARNET	115	1.28	G3	LA Basin	Eastern, Valley-Devers	Aug NQC	Market

Attachment A - List of physical resources by PTO, local area and market ID

SCE	GARNET_1_UNITS	24815	GARNET	115	0.56	G2	LA Basin	Eastern, Valley-Devers	Aug NQC	Market
SCE	GARNET_1_WIND	24815	GARNET	115	1.37		LA Basin	Eastern, Valley-Devers	Not modeled Aug NQC	Wind
SCE	GARNET_1_WINDS	24815	GARNET	115	4.73	W2	LA Basin	Eastern, Valley-Devers	Aug NQC	Wind
SCE	GARNET_1_WT3WND	24815	GARNET	115	0.00	W3	LA Basin	Eastern, Valley-Devers	Aug NQC	Market
SCE	GARNET_2_HYDRO	24815	GARNET	115	0.51	QF	LA Basin	Eastern, Valley-Devers	Aug NQC	Market
SCE	GARNET_2_WIND1	24815	GARNET	115	2.35		LA Basin	Eastern, Valley-Devers	Not modeled Aug NQC	Wind
SCE	GARNET_2_WIND2	24815	GARNET	115	2.46		LA Basin	Eastern, Valley-Devers	Not modeled Aug NQC	Wind
SCE	GARNET_2_WIND3	24815	GARNET	115	2.65		LA Basin	Eastern, Valley-Devers	Not modeled Aug NQC	Wind
SCE	GARNET_2_WIND4	24815	GARNET	115	2.06		LA Basin	Eastern, Valley-Devers	Not modeled Aug NQC	Wind
SCE	GARNET_2_WIND5	24815	GARNET	115	0.63		LA Basin	Eastern, Valley-Devers	Not modeled Aug NQC	Wind
SCE	GARNET_2_WPMWD6	24815	GARNET	115	1.25		LA Basin	Eastern, Valley-Devers	Not modeled Aug NQC	Wind
SCE	GLNARM_2_UNIT 5	29013	GLENARM5_C T	13.8	50.00	CT	LA Basin	Western		MUNI
SCE	GLNARM_2_UNIT 5	29014	GLENARM5_S T	13.8	15.00	ST	LA Basin	Western		MUNI
SCE	GLNARM_7_UNIT 1	29005	PASADNA1	13.8	18.00	1	LA Basin	Western		MUNI
SCE	GLNARM_7_UNIT 2	29006	PASADNA2	13.8	18.80	1	LA Basin	Western		MUNI
SCE	GLNARM_7_UNIT 3	25042	PASADNA3	13.8	44.83	1	LA Basin	Western		MUNI
SCE	GLNARM_7_UNIT 4	25043	PASADNA4	13.8	42.42	1	LA Basin	Western		MUNI
SCE	HARBGN_7_UNITS	24062	HARBOR G	13.8	76.27	1	LA Basin	Western		Market
SCE	HARBGN_7_UNITS	24062	HARBOR G	13.8	11.86	HP	LA Basin	Western		Market
SCE	HARBGN_7_UNITS	25510	HARBORG4	4.16	11.86	LP	LA Basin	Western		Market
SCE	HINSON_6_CARBG	24020	CARBGEN1	13.8	14.71	1	LA Basin	Western	Aug NQC	Market
SCE	HINSON_6_CARBG	24328	CARBGEN2	13.8	14.71	1	LA Basin	Western	Aug NQC	Market
SCE	HINSON_6_LBECH1	24170	LBEACH12	13.8	63.00	1	LA Basin	Western		Market
SCE	HINSON_6_LBECH2	24170	LBEACH12	13.8	63.00	2	LA Basin	Western		Market
SCE	HINSON_6_LBECH3	24171	LBEACH34	13.8	63.00	3	LA Basin	Western		Market

Attachment A - List of physical resources by PTO, local area and market ID

SCE	HINSON_6_LBECH4	24171	LBEACH34	13.8	63.00	4	LA Basin	Western		Market
SCE	HINSON_6_SERRGN	24139	SERRFGEN	13.8	34.00	D1	LA Basin	Western	Aug NQC	Market
SCE	HNTGBH_2_PL1X3	24582	HUNTBCH STG	18	251.34	S1	LA Basin	Western		Market
SCE	HNTGBH_2_PL1X3	24580	HUNTBCH CTG1	18	211.23	G1	LA Basin	Western		Market
SCE	HNTGBH_2_PL1X3	24581	HUNTBCH CTG2	18	211.23	G2	LA Basin	Western		Market
SCE	HNTGBH_7_UNIT 2	24067	HUNT2 G	13.8	0.00	2	LA Basin	Western	Retired by 2024	Market
SCE	INDIGO_1_UNIT 1	29190	WINTECX2	13.8	45.00	1	LA Basin	Eastern, Valley- Devers		Market
SCE	INDIGO_1_UNIT 2	29191	WINTECX1	13.8	45.00	1	LA Basin	Eastern, Valley- Devers		Market
SCE	INDIGO_1_UNIT 3	29180	WINTEC8	13.8	45.00	1	LA Basin	Eastern, Valley- Devers		Market
SCE	JOANEC_2_STABT1	25663	WDT1396_G	12.5	20.00	1	LA Basin	Western		Battery
SCE	JOANEC_2_STABT2	25663	WDT1396_G	12.5	20.00	1	LA Basin	Western		Battery
SCE	JOHANN_2_JOSBT1	698403	JOHANNA_PR P	66	10.00	EQ	LA Basin	Western		Battery
SCE	JOHANN_2_JOSBT2	698403	JOHANNA_PR P	66	10.00	EQ	LA Basin	Western		Battery
SCE	JOHANN_2_OCEBT2	698403	JOHANNA_PR P	66	9.00	EQ	LA Basin	Western		Battery
SCE	JOHANN_2_OCEBT3	698403	JOHANNA_PR P	66	6.00	EQ	LA Basin	Western		Battery
SCE	LACIEN_2_VENICE	24337	VENICE	13.8	0.00	1	LA Basin	Western, El Nido	Aug NQC	MUNI
SCE	LGHTHP_6_ICEGEN	24070	ICEGEN	13.8	48.00	1	LA Basin	Western	Aug NQC	QF/Selfgen
SCE	MIRLOM_2_CORONA				0.98		LA Basin	Eastern	Not modeled Aug NQC	QF/Selfgen
SCE	MIRLOM_2_CREST				0.00		LA Basin	Eastern	Not modeled Aug NQC	Market
SCE	MIRLOM_2_LNDFL				0.81		LA Basin	Eastern	Not modeled Aug NQC	Market
SCE	MIRLOM_2_MLBBTA	25185	WDT1425_G1	0.48	10.00	1	LA Basin	Eastern	Aug NQC	Battery
SCE	MIRLOM_2_MLBBTB	25186	WDT1426_G2	0.48	10.00	1	LA Basin	Eastern	Aug NQC	Battery
SCE	MIRLOM_2_ONTARO				1.49		LA Basin	Eastern	Not modeled Aug NQC	Market

Attachment A - List of physical resources by PTO, local area and market ID

SCE	MIRLOM_2_RTS032				0.41		LA Basin	Eastern	Not modeled Aug NQC	Market
SCE	MIRLOM_2_RTS033				0.27		LA Basin	Eastern	Not modeled Aug NQC	Market
SCE	MIRLOM_2_TEMESC				0.77		LA Basin	Eastern	Not modeled Aug NQC	QF/Selfgen
SCE	MIRLOM_6_PEAKER	29307	MRLPKGEN	13.8	46.00	1	LA Basin	Eastern		Market
SCE	MIRLOM_7_MWDLKM	24210	MIRALOMA	66	3.20		LA Basin	Eastern	Not modeled Aug NQC	MUNI
SCE	MOJAVE_1_SIPHON	25657	MJVSPHN1	13.8	2.13	1	LA Basin	Eastern	Aug NQC	Market
SCE	MOJAVE_1_SIPHON	25658	MJVSPHN1	13.8	2.13	2	LA Basin	Eastern	Aug NQC	Market
SCE	MOJAVE_1_SIPHON	25659	MJVSPHN1	13.8	2.13	3	LA Basin	Eastern	Aug NQC	Market
SCE	MTWIND_1_UNIT 1	29060	MOUNTWND	115	9.32	S1	LA Basin	Eastern, Valley-Devers	Aug NQC	Wind
SCE	MTWIND_1_UNIT 2	29060	MOUNTWND	115	4.66	S2	LA Basin	Eastern, Valley-Devers	Aug NQC	Wind
SCE	MTWIND_1_UNIT 3	29060	MOUNTWND	115	4.71	S3	LA Basin	Eastern, Valley-Devers	Aug NQC	Wind
SCE	OLINDA_2_COYCRK	24211	OLINDA	66	3.13		LA Basin	Western	Not modeled	QF/Selfgen
SCE	OLINDA_2_LNDFL2	29011	BREAPWR2	13.8	7.62	S1	LA Basin	Western	Aug NQC	Market
SCE	OLINDA_2_LNDFL2	29011	BREAPWR2	13.8	4.26	C1	LA Basin	Western	Aug NQC	Market
SCE	OLINDA_2_LNDFL2	29011	BREAPWR2	13.8	4.26	C2	LA Basin	Western	Aug NQC	Market
SCE	OLINDA_2_LNDFL2	29011	BREAPWR2	13.8	4.26	C3	LA Basin	Western	Aug NQC	Market
SCE	OLINDA_2_LNDFL2	29011	BREAPWR2	13.8	4.26	C4	LA Basin	Western	Aug NQC	Market
SCE	OLINDA_7_BLKSDND	24211	OLINDA	66	0.08		LA Basin	Western	Not modeled Aug NQC	Market
SCE	PADUA_2_ONTARO	24111	PADUA	66	0.75		LA Basin	Eastern	Not modeled Aug NQC	QF/Selfgen
SCE	PADUA_2_SOLAR1	24111	PADUA	66	0.00		LA Basin	Eastern	Not modeled Energy Only	Solar
SCE	PADUA_6_MWSDSM	24111	PADUA	66	0.00		LA Basin	Eastern	Not modeled Aug NQC	MUNI
SCE	PADUA_6_QF	24111	PADUA	66	0.53		LA Basin	Eastern	Not modeled Aug NQC	QF/Selfgen
SCE	PADUA_7_SDIMAS	24111	PADUA	66	1.05		LA Basin	Eastern	Not modeled Aug NQC	Market
SCE	PWEST_1_UNIT	24815	GARNET	115	0.44	PC	LA Basin	Western	Aug NQC	Market
SCE	REDOND_7_UNIT 5	24121	REDON5 G	18	0.00	5	LA Basin	Western	Retired by 2024	Market



Attachment A - List of physical resources by PTO, local area and market ID

SCE	REDOND_7_UNIT 6	24122	REDON6 G	18	0.00	6	LA Basin	Western	Retired by 2024	Market
SCE	REDOND_7_UNIT 8	24124	REDON8 G	20	0.00	8	LA Basin	Western	Retired by 2024	Market
SCE	RENWD_1_QF	25636	RENWIND	115	1.05	Q1	LA Basin	Eastern, Valley-Devers	Aug NQC	QF/Selfgen
SCE	RENWD_1_QF	25636	RENWIND	115	1.05	Q2	LA Basin	Eastern, Valley-Devers	Aug NQC	QF/Selfgen
SCE	RVSIIDE_2_RERCU3	24299	RERC2G3	13.8	49.00	1	LA Basin	Eastern		MUNI
SCE	RVSIIDE_2_RERCU4	24300	RERC2G4	13.8	49.00	1	LA Basin	Eastern		MUNI
SCE	RVSIIDE_6_RERCU1	24242	RERC1G	13.8	48.35	1	LA Basin	Eastern		MUNI
SCE	RVSIIDE_6_RERCU2	24243	RERC2G	13.8	48.50	1	LA Basin	Eastern		MUNI
SCE	RVSIIDE_6_SOLAR1	24244	SPRINGEN	13.8	2.03		LA Basin	Eastern	Not modeled Aug NQC	Solar
SCE	RVSIIDE_6_SPRING	24244	SPRINGEN	13.8	36.00	1	LA Basin	Eastern		Market
SCE	SANITR_6_UNITS	24324	SANIGEN	13.8	0.37	D1	LA Basin	Eastern	Aug NQC	QF/Selfgen
SCE	SANTGO_2_LNDFL1	24341	COYGEN	13.8	18.96	1	LA Basin	Western	Aug NQC	Market
SCE	SANTGO_2_MABBT1	25192	WDT1406_G	0.48	2.00	1	LA Basin	Western	Aug NQC	Battery
SCE	SANWD_1_QF	25646	SANWIND	115	3.26	Q1	LA Basin	Eastern, Valley-Devers	Aug NQC	Wind
SCE	SANWD_1_QF	25646	SANWIND	115	3.26	Q2	LA Basin	Eastern, Valley-Devers	Aug NQC	Wind
SCE	SBERDO_2_PSP3	24923	MNTV-ST1	18	257.82	1	LA Basin	Eastern, West of Devers		Market
SCE	SBERDO_2_PSP3	24921	MNTV-CT1	18	148.59	1	LA Basin	Eastern, West of Devers		Market
SCE	SBERDO_2_PSP3	24922	MNTV-CT2	18	148.59	1	LA Basin	Eastern, West of Devers		Market
SCE	SBERDO_2_PSP4	24926	MNTV-ST2	18	257.82	1	LA Basin	Eastern, West of Devers		Market
SCE	SBERDO_2_PSP4	24924	MNTV-CT3	18	148.59	1	LA Basin	Eastern, West of Devers		Market
SCE	SBERDO_2_PSP4	24925	MNTV-CT4	18	148.59	1	LA Basin	Eastern, West of Devers		Market
SCE	SBERDO_2_REDLND	24214	SANBRDNO	66	0.54		LA Basin	Eastern, West of Devers	Not modeled Aug NQC	Market
SCE	SBERDO_2_RTS005	24214	SANBRDNO	66	0.68		LA Basin	Eastern, West of Devers	Not modeled Aug NQC	Market

Attachment A - List of physical resources by PTO, local area and market ID

SCE	SBERDO_2_RTS007	24214	SANBRDNO	66	0.68		LA Basin	Eastern, West of Devers	Not modeled Aug NQC	Market
SCE	SBERDO_2_RTS011	24214	SANBRDNO	66	0.95		LA Basin	Eastern, West of Devers	Not modeled Aug NQC	Market
SCE	SBERDO_2_RTS013	24214	SANBRDNO	66	0.95		LA Basin	Eastern, West of Devers	Not modeled Aug NQC	Market
SCE	SBERDO_2_RTS016	24214	SANBRDNO	66	0.41		LA Basin	Eastern, West of Devers	Not modeled Aug NQC	Market
SCE	SBERDO_2_RTS048	24214	SANBRDNO	66	0.00		LA Basin	Eastern, West of Devers	Not modeled Energy Only	Market
SCE	SBERDO_2_SNTANA	24214	SANBRDNO	66	0.28		LA Basin	Eastern, West of Devers	Not modeled Aug NQC	QF/Selfgen
SCE	SBERDO_6_MILLCK	24214	SANBRDNO	66	1.33		LA Basin	Eastern, West of Devers	Not modeled Aug NQC	QF/Selfgen
SCE	SENTNL_2_CTG1	29101	SENTINEL_G1	13.8	107.68	1	LA Basin	Eastern, Valley-Devers		Market
SCE	SENTNL_2_CTG2	29102	SENTINEL_G2	13.8	102.50	1	LA Basin	Eastern, Valley-Devers		Market
SCE	SENTNL_2_CTG3	29103	SENTINEL_G3	13.8	105.69	1	LA Basin	Eastern, Valley-Devers		Market
SCE	SENTNL_2_CTG4	29104	SENTINEL_G4	13.8	106.55	1	LA Basin	Eastern, Valley-Devers		Market
SCE	SENTNL_2_CTG5	29105	SENTINEL_G5	13.8	107.52	1	LA Basin	Eastern, Valley-Devers		Market
SCE	SENTNL_2_CTG6	29106	SENTINEL_G6	13.8	105.00	1	LA Basin	Eastern, Valley-Devers		Market
SCE	SENTNL_2_CTG7	29107	SENTINEL_G7	13.8	106.73	1	LA Basin	Eastern, Valley-Devers		Market
SCE	SENTNL_2_CTG8	29108	SENTINEL_G8	13.8	106.85	1	LA Basin	Eastern, Valley-Devers		Market
SCE	STANTN_2_STAGT1	25670	WH_STN_1	13.8	49.65	1	LA Basin	Western		Market
SCE	STANTN_2_STAGT2	25671	WH_STN_2	13.8	49.65	1	LA Basin	Western		Market
SCE	TIFFNY_1_DILLON	29021	WINTEC6	115	9.45	1	LA Basin	Eastern, Valley-Devers	Aug NQC	Wind
SCE	TRNSWD_1_QF	25637	TRANWIND	115	8.18	QF	LA Basin	Eastern, Valley-Devers	Aug NQC	Wind
SCE	TULEWD_1_TULWD1				27.41		LA Basin	Eastern, Valley-Devers	Not modeled Aug NQC	Wind
SCE	VALLEY_5_PERRIS	24160	VALLEYSC	115	7.94		LA Basin	Eastern, Valley, Valley-Devers	Not modeled Aug NQC	QF/Selfgen

Attachment A - List of physical resources by PTO, local area and market ID

SCE	VALLEY_5_REDMTN	24160	VALLEYSC	115	0.04		LA Basin	Eastern, Valley, Valley-Devers	Not modeled Aug NQC	QF/Selfgen
SCE	VALLEY_5_SOLAR1	24160	VALLEYSC	115	0.00		LA Basin	Eastern, Valley, Valley-Devers	Not modeled Energy Only	Solar
SCE	VALLEY_5_SOLAR2	25082	WDT786	34.5	5.40	EQ	LA Basin	Eastern, Valley, Valley-Devers	Aug NQC	Solar
SCE	VENWD_1_WIND3	25645	VENWIND	115	9.35	EU	LA Basin	Eastern, Valley-Devers	Aug NQC	Wind
SCE	VERNON_6_GONZL1	24342	FEDGEN	13.8	5.75	1	LA Basin	Western		MUNI
SCE	VERNON_6_GONZL2	24342	FEDGEN	13.8	5.75	1	LA Basin	Western		MUNI
SCE	VERNON_6_MALBRG	24241	MALBRG3G	13.8	49.26	S3	LA Basin	Western		MUNI
SCE	VERNON_6_MALBRG	24239	MALBRG1G	13.8	42.37	C1	LA Basin	Western		MUNI
SCE	VERNON_6_MALBRG	24240	MALBRG2G	13.8	42.37	C2	LA Basin	Western		MUNI
SCE	VILLPK_2_VALLYV	24216	VILLA PK	66	4.10	DG	LA Basin	Western	Aug NQC	QF/Selfgen
SCE	VILLPK_6_MWDYOR	24216	VILLA PK	66	2.40		LA Basin	Western	Not modeled Aug NQC	MUNI
SCE	VISTA_2_RIALTO	24901	VSTA	230	0.27		LA Basin	Eastern	Not modeled	Market
SCE	VISTA_2_RTS028	24901	VSTA	230	0.95		LA Basin	Eastern	Not modeled Aug NQC	Market
SCE	VISTA_6_QF	24902	VSTA	66	0.11		LA Basin	Eastern	Not modeled Aug NQC	QF/Selfgen
SCE	WALCRK_2_CTG1	29201	WALCRKG1	13.8	96.43	1	LA Basin	Western		Market
SCE	WALCRK_2_CTG2	29202	WALCRKG2	13.8	96.91	1	LA Basin	Western		Market
SCE	WALCRK_2_CTG3	29203	WALCRKG3	13.8	96.65	1	LA Basin	Western		Market
SCE	WALCRK_2_CTG4	29204	WALCRKG4	13.8	96.49	1	LA Basin	Western		Market
SCE	WALCRK_2_CTG5	29205	WALCRKG5	13.8	96.65	1	LA Basin	Western		Market
SCE	WALNUT_2_SOLAR				0.00		LA Basin	Western	Not modeled Energy Only	Solar
SCE	WALNUT_6_HILLGEN	24063	HILLGEN	13.8	25.58	D1	LA Basin	Western	Aug NQC	Net Seller
SCE	WALNUT_7_WCOVST	24157	WALNUT	66	5.35		LA Basin	Western	Not modeled Aug NQC	Market
SCE	WHTWTR_1_WINDA1	29061	WHITEWTR	33	12.92	1	LA Basin	Eastern, Valley-Devers	Aug NQC	Wind
SCE	ZZ_ARCOGN_2_UNITS	24018	BRIGEN	13.8	0.00	1	LA Basin	Western	No NQC - hist. data	Net Seller
SCE	ZZ_HINSON_6_QF	24064	HINSON	66	0.00	1	LA Basin	Western	No NQC - hist. data	QF/Selfgen

Attachment A - List of physical resources by PTO, local area and market ID

SCE	ZZ_LAFRES_6_QF	24332	PALOGEN	13.8	0.00	D1	LA Basin	Western, El Nido	No NQC - hist. data	QF/Selfgen
SCE	ZZ_MOBGEN_6_UNIT 1	24094	MOBGEN	13.8	0.00	1	LA Basin	Western, El Nido	No NQC - hist. data	QF/Selfgen
SCE	ZZ_NA	25849	NEWARK FD1	16	4.39	EQ	LA Basin	Western	No NQC - est. data	Solar
SCE	ZZ_NA	25857	RIOHNDO EQFD	12.5	0.20	EQ	LA Basin	Western	No NQC - est. data	Solar
SCE	ZZ_NA	25889	WALNUT EQFD	12.5	0.20	EQ	LA Basin	Western	No NQC - est. data	Solar
SCE	ZZ_NA	25883	VILLAPK EQFD	12.5	0.14	EQ	LA Basin	Western	No NQC - est. data	Solar
SCE	ZZ_NA	25820	EL NIDO EQFD	16	0.09	EQ	LA Basin	Western, El Nido	No NQC - est. data	Solar
SCE	ZZ_NA	25838	LA FRSA EQFD	16	0.07	EQ	LA Basin	Western	No NQC - est. data	Solar
SCE	ZZ_NA	25842	MESACAL EQFD	16	0.01	EQ	LA Basin	Western	No NQC - est. data	Solar
SCE	ZZ_NA	24327	THUMSGEN	13.8	0.00	1	LA Basin	Western	No NQC - hist. data	QF/Selfgen
SCE	ZZ_NA	24329	MOBGEN2	13.8	0.00	1	LA Basin	Western, El Nido	No NQC - hist. data	QF/Selfgen
SCE	ZZ_NA	24330	OUTFALL1	13.8	0.00	1	LA Basin	Western, El Nido	No NQC - hist. data	QF/Selfgen
SCE	ZZ_NA	24331	OUTFALL2	13.8	0.00	1	LA Basin	Western, El Nido	No NQC - hist. data	QF/Selfgen
SCE	ZZ_NA	29260	ALTAMSA4	115	0.00	1	LA Basin	Eastern, Valley-Devers	No NQC - hist. data	Wind
SCE	ZZ_VENWD_1_WIND1	25645	VENWIND	115	0.00	Q1	LA Basin	Eastern, Valley-Devers	Mothballed	QF/Selfgen
SCE	ZZ_VENWD_1_WIND2	25645	VENWIND	115	0.00	Q2	LA Basin	Eastern, Valley-Devers	Mothballed	QF/Selfgen
SCE	ZZZ_New Unit	25675	WH_STN_5	0.55	0.00	1	LA Basin	Western	No NQC - est. data	Battery
SCE	ZZZ_New Unit	25677	WH_STN_7	0.55	0.00	1	LA Basin	Western	No NQC - est. data	Battery
SCE	ZZZZA_New Unit	102188	PR_WALNUT_G	0.66	300.00	1	LA Basin	Western	No NQC - est. data	Battery
SCE	ZZZZA_New Unit	102178	PR_LAGBEL_G2	0.66	250.00	1	LA Basin	Western	No NQC - est. data	Battery

Attachment A - List of physical resources by PTO, local area and market ID

SCE	ZZZZA_New Unit	102185	PR_LAGBEL_G1	0.66	250.00	1	LA Basin	Western	No NQC - est. data	Battery
SCE	ZZZZA_New Unit	97589	TOT789_G1	0.48	202.50	1	LA Basin	Eastern, Valley-Devers		Battery
SCE	ZZZZA_New Unit	97591	TOT789_G2	0.48	202.50	1	LA Basin	Eastern, Valley-Devers		Battery
SCE	ZZZZA_New Unit	102176	PR_HINSON_G	0.66	200.00	1	LA Basin	Western	No NQC - est. data	Battery
SCE	ZZZZA_New Unit	102173	RP_ETWENDA_G	0.66	101.00	VE	LA Basin	Eastern		Battery
SCE	ZZZZA_New Unit	100713	CABAZON_ST G	0.48	92.30	1	LA Basin	Eastern, Valley-Devers		Market
SCE	ZZZZA_New Unit	100712	CABAZON_W ND	0.65	6.66	1	LA Basin	Eastern, Valley-Devers		Wind
SCE	ZZZZA_New Unit	102507	RP_VIST_1GB M	0.36	3.00	VB	LA Basin	Eastern		Market
SCE	ZZZZZ_ALAMIT_7_UNIT 1	24001	ALAMT1 G	18	0.00	1	LA Basin	Western	Retired	Market
SCE	ZZZZZ_ALAMIT_7_UNIT 2	24002	ALAMT2 G	18	0.00	2	LA Basin	Western	Retired	Market
SCE	ZZZZZ_ALAMIT_7_UNIT 6	24161	ALAMT6 G	20	0.00	6	LA Basin	Western	Retired	Market
SCE	ZZZZZ_ANAHM_7_CT	25208	DowlingCTG	13.8	0.00	1	LA Basin	Western	Retired	MUNI
SCE	ZZZZZ_BRDWAY_7_UNIT 3	29007	BRODWYSC	13.8	0.00		LA Basin	Western	Retired	MUNI
SCE	ZZZZZ_CENTER_2_QF	29953	SIGGEN	13.8	0.00	D1	LA Basin	Western	Retired	QF/Selfgen
SCE	ZZZZZ_CHINO_6_SMPPA P	24140	SIMPSON	13.8	0.00	D1	LA Basin	Eastern	Retired	QF/Selfgen
SCE	ZZZZZ_ETIWND_7_MIDVLY	24055	ETIWANDA	66	0.00		LA Basin	Eastern	Retired	QF/Selfgen
SCE	ZZZZZ_ETIWND_7_UNIT 3	24052	MTNVIST3	18	0.00	3	LA Basin	Eastern	Retired	Market
SCE	ZZZZZ_ETIWND_7_UNIT 4	24053	MTNVIST4	18	0.00	4	LA Basin	Eastern	Retired	Market
SCE	ZZZZZ_GARNET_2_DIFW D1	24815	GARNET	115	0.00		LA Basin	Eastern, Valley-Devers	Retired	Market
SCE	ZZZZZ_HNTGBH_7_UNIT 1	24066	HUNT1 G	13.8	0.00	1	LA Basin	Western	Retired	Market
SCE	ZZZZZ_INLDEM_5_UNIT 1	29041	IIEC-G1	19.5	0.00	1	LA Basin	Eastern, Valley, Valley-Devers	Retired	Market
SCE	ZZZZZ_INLDEM_5_UNIT 2	29042	IIEC-G2	19.5	0.00	1	LA Basin	Eastern, Valley, Valley-Devers	Retired	Market
SCE	ZZZZZ_LAGBEL_2_STG1				0.00		LA Basin	Western	Retired	Market

Attachment A - List of physical resources by PTO, local area and market ID

SCE	ZZZZ_LAGBEL_6_QF	29951	REFUSE	13.8	0.00	D1	LA Basin	Western	Retired	QF/Selfgen
SCE	ZZZZ_MESAS_2_QF	24209	MESA CAL	66	0.00		LA Basin	Western	Retired	QF/Selfgen
SCE	ZZZZ_MIRLOM_6_DELGEN	29339	DELGEN	13.8	0.00	1	LA Basin	Eastern	Retired	QF/Selfgen
SCE	ZZZZ_OLINDA_2_QF	24211	OLINDA	66	0.00		LA Basin	Western	Retired	QF/Selfgen
SCE	ZZZZ_OLINDA_7_LNDFIL	24211	OLINDA	66	0.00		LA Basin	Western	Retired	QF/Selfgen
SCE	ZZZZ_PANSEA_1_PANARO	25640	PANAERO	115	0.00	QF	LA Basin	Eastern, Valley-Devers	Retired	Wind
SCE	ZZZZ_REDOND_7_UNIT7	24123	REDON7 G	20	0.00	7	LA Basin	Western	Retired	Market
SCE	ZZZZ_RHONDO_2_QF	24213	RIOHONDO	66	0.00	DG	LA Basin	Western	Retired	QF/Selfgen
SCE	ZZZZ_RHONDO_6_PUENTE	24213	RIOHONDO	66	0.00		LA Basin	Western	Retired	Net Seller
SCE	ZZZZ_SBERDO_2_QF	24214	SANBRDNO	66	0.00		LA Basin	Eastern, West of Devers	Retired	QF/Selfgen
SCE	ZZZZ_VALLEY_5_RTS044	24160	VALLEYSC	115	0.00		LA Basin	Eastern, Valley, Valley-Devers	Retired	Market
SCE	ZZZZ_VALLEY_7_BADLAND	24160	VALLEYSC	115	0.00		LA Basin	Eastern, Valley, Valley-Devers	Retired	Market
SCE	ZZZZ_VALLEY_7_UNITA1	24160	VALLEYSC	115	0.00		LA Basin	Eastern, Valley, Valley-Devers	Retired	Market
SCE	ZZZZ_WALNUT_7_WCOVCT	24157	WALNUT	66	0.00		LA Basin	Western	Retired	Market
SCE	ZZZZ_ELSEGN_7_UNIT4	24048	ELSEG4 G	18	0.00	4	LA Basin	Western, El Nido	Retired	Market
SDG&E	BORDER_6_UNITA1	22149	CALPK_BD	13.8	51.25	1	SD-IV	San Diego, Border		Market
SDG&E	BREGGO_6_DEGRSL	22085	BORREGO	12.5	1.70	DG	SD-IV	San Diego	Aug NQC	Solar
SDG&E	BREGGO_6_SOLAR	22082	BR GEN1	0.21	7.02	1	SD-IV	San Diego	Aug NQC	Solar
SDG&E	CARLS1_2_CARCT1	22783	EA5 REPOWER1	13.8	105.50	1	SD-IV	San Diego	Aug NQC	Market
SDG&E	CARLS1_2_CARCT1	22784	EA5 REPOWER2	13.8	105.50	1	SD-IV	San Diego	Aug NQC	Market
SDG&E	CARLS1_2_CARCT1	22786	EA5 REPOWER4	13.8	105.50	1	SD-IV	San Diego	Aug NQC	Market
SDG&E	CARLS1_2_CARCT1	22788	EA5 REPOWER3	13.8	105.50	1	SD-IV	San Diego	Aug NQC	Market
SDG&E	CARLS2_1_CARCT1	22787	EA5 REPOWER5	13.8	105.50	1	SD-IV	San Diego	Aug NQC	Market

Attachment A - List of physical resources by PTO, local area and market ID

SDG&E	CHILLS_1_SYCENG	22120	CARLTNHS	138	0.70	1	SD-IV	San Diego	Aug NQC	QF/Selfgen
SDG&E	CHILLS_7_UNITA1	22120	CARLTNHS	138	1.52	2	SD-IV	San Diego	Aug NQC	QF/Selfgen
SDG&E	CNTNLA_2_SOLAR1	23463	DW GEN3&4	0.33	33.75	1	SD-IV		Aug NQC	Solar
SDG&E	CNTNLA_2_SOLAR2	23463	DW GEN3&4	0.33	12.31	2	SD-IV		Aug NQC	Solar
SDG&E	CPSTNO_7_PRMADS	22112	CAPSTRNO	138	5.12	1	SD-IV	San Diego	Aug NQC	Market
SDG&E	CPVERD_2_SOLAR	23309	IV GEN3 G1	0.31	20.85	G1	SD-IV		Aug NQC	Solar
SDG&E	CPVERD_2_SOLAR	23301	IV GEN3 G2	0.31	16.68	G2	SD-IV		Aug NQC	Solar
SDG&E	CRELMN_6_RAMON1	22152	CREELMAN	69	0.54	DG	SD-IV	San Diego	Aug NQC	Solar
SDG&E	CRELMN_6_RAMON2	22152	CREELMAN	69	1.35	DG	SD-IV	San Diego	Aug NQC	Solar
SDG&E	CRELMN_6_RAMSR3				0.94		SD-IV	San Diego	Not modeled Aug NQC	Solar
SDG&E	CRSTWD_6_KUMYAY	22915	KUMEYAAY	0.69	10.50	1	SD-IV	San Diego	Aug NQC	Wind
SDG&E	CSLR4S_2_SOLAR	23298	DW GEN1 G1	0.32	17.55	G1	SD-IV		Aug NQC	Solar
SDG&E	CSLR4S_2_SOLAR	23299	DW GEN1 G2	0.32	17.55	G2	SD-IV		Aug NQC	Solar
SDG&E	ELCAJN_6_EB1BT1	22208	EL CAJON	69	7.50	1	SD-IV	San Diego, El Cajon		Battery
SDG&E	ELCAJN_6_LM6K	23320	EC GEN2	13.8	48.10	1	SD-IV	San Diego, El Cajon		Market
SDG&E	ELCAJN_6_UNITA1	22150	EC GEN1	13.8	45.42	1	SD-IV	San Diego, El Cajon		Market
SDG&E	ENERSJ_2_WIND	23100	ECO GEN1 G1	0.69	32.57	G1	SD-IV		Aug NQC	Wind
SDG&E	ESCND0_6_EB1BT1	22256	ESCNDIDO	69	10.00	10	SD-IV	San Diego		Battery
SDG&E	ESCND0_6_EB2BT2	22256	ESCNDIDO	69	10.00	11	SD-IV	San Diego		Battery
SDG&E	ESCND0_6_EB3BT3	22256	ESCNDIDO	69	10.00	12	SD-IV	San Diego		Battery
SDG&E	ESCND0_6_PL1X2	22257	ESGEN	13.8	48.71	1	SD-IV	San Diego		Market
SDG&E	ESCND0_6_UNITB1	22153	CALPK_ES	13.8	48.04	1	SD-IV	San Diego		Market
SDG&E	ESCO_6_GLMQF	22332	GOALLINE	69	49.90	1	SD-IV	San Diego	Aug NQC	Net Seller
SDG&E	GATEWY_2_GESBT1	23710	OM GEN4_BESS	0.51	175.00	1	SD-IV	San Diego		Battery
SDG&E	IVSLR2_2_SM2SR1	23441	DW GEN6	0.42	40.50	1	SD-IV		Aug NQC	Solar
SDG&E	IVSLRP_2_SOLAR1	23440	DW GEN2 G1	0.36	54.00	1	SD-IV		Aug NQC	Solar
SDG&E	IWEST_2_SOLAR1	23155	DU GEN1 G1	0.2	47.73	G1	SD-IV		Aug NQC	Solar
SDG&E	IWEST_2_SOLAR1	23156	DU GEN1 G2	0.2	18.59	G2	SD-IV		Aug NQC	Solar
SDG&E	JACMSR_1_JACSR1	23352	ECO GEN2	0.55	5.40	1	SD-IV		Aug NQC	Solar
SDG&E	KYCORA_6_KMSBT1				0.00		SD-IV	San Diego	Not modeled Energy Only	Battery

Attachment A - List of physical resources by PTO, local area and market ID

SDG&E	LAKHDG_6_UNIT 1	22625	LKHODG1	13.8	20.00	1	SD-IV	San Diego		Market
SDG&E	LAKHDG_6_UNIT 2	22626	LKHODG2	13.8	20.00	2	SD-IV	San Diego		Market
SDG&E	LARKSP_6_UNIT 1	22074	LRKSPBD1	13.8	46.10	1	SD-IV	San Diego, Border		Market
SDG&E	LARKSP_6_UNIT 2	22075	LRKSPBD2	13.8	47.98	1	SD-IV	San Diego, Border		Market
SDG&E	LAROA1_2_UNITA1	20187	LRP-U1	16	0.00	1	SD-IV		Connect to CENACE/CF E grid for the summer – not available for ISO BAA RA purpose	Market
SDG&E	LAROA2_2_UNITA1	22997	INTBCT	16	176.81	1	SD-IV			Market
SDG&E	LAROA2_2_UNITA1	22996	INTBST	18	145.19	1	SD-IV			Market
SDG&E	LILIAC_6_SOLAR	22404	LILIAC	69	0.81	DG	SD-IV	San Diego		Solar
SDG&E	MRGT_6_MEF2	22487	MEF_MR2	13.8	44.00	1	SD-IV	San Diego		Market
SDG&E	MRGT_6_MMAREF	22486	MEF_MR1	13.8	45.00	1	SD-IV	San Diego		Market
SDG&E	MRGT_6_TGEBT1	23412	Q1434_G	0.64	30.00	1	SD-IV	San Diego		Battery
SDG&E	MSHGTS_6_MMARLF	22448	MESAHGTS	69	3.67	1	SD-IV	San Diego	Aug NQC	Market
SDG&E	MSSION_2_QF	22496	MISSION	69	0.37	1	SD-IV	San Diego	Aug NQC	Market
SDG&E	MURRAY_6_UNIT	22532	MURRAY	69	0.00		SD-IV	San Diego	Not modeled Energy Only	Market
SDG&E	OCTILO_5_WIND	23314	OCO GEN G1	0.69	27.83	G1	SD-IV		Aug NQC	Wind
SDG&E	OCTILO_5_WIND	23318	OCO GEN G2	0.69	27.83	G2	SD-IV		Aug NQC	Wind
SDG&E	OGROVE_6_PL1X2	22628	PA GEN1	13.8	48.00	1	SD-IV	San Diego		Market
SDG&E	OGROVE_6_PL1X2	22629	PA GEN2	13.8	48.00	1	SD-IV	San Diego		Market
SDG&E	OTAY_6_PL1X2	22617	OYGEN	13.8	37.20	1	SD-IV	San Diego		Market
SDG&E	OTMESA_2_PL1X3	22607	OTAYMST1	16	272.27	1	SD-IV	San Diego		Market
SDG&E	OTMESA_2_PL1X3	22606	OTAYMGT2	18	166.17	1	SD-IV	San Diego		Market
SDG&E	OTMESA_2_PL1X3	22605	OTAYMGT1	18	165.16	1	SD-IV	San Diego		Market
SDG&E	PALOMR_2_PL1X3	22265	PEN_ST	18	234.24	1	SD-IV	San Diego		Market
SDG&E	PALOMR_2_PL1X3	22262	PEN_CT1	18	176.98	1	SD-IV	San Diego		Market
SDG&E	PALOMR_2_PL1X3	22263	PEN_CT2	18	176.98	1	SD-IV	San Diego		Market
SDG&E	PIOPIC_2_CTG1	23162	PIO PICO CT1	13.8	111.30	1	SD-IV	San Diego	No NQC - Pmax	Market
SDG&E	PIOPIC_2_CTG2	23163	PIO PICO CT2	13.8	112.70	1	SD-IV	San Diego	No NQC - Pmax	Market



Attachment A - List of physical resources by PTO, local area and market ID

SDG&E	PIOPIC_2_CTG3	23164	PIO PICO CT3	13.8	112.00	1	SD-IV	San Diego	No NQC - Pmax	Market
SDG&E	PRCTVY_1_MIGBT1				0.00		SD-IV	San Diego	Aug NQC	Battery
SDG&E	PTLOMA_6_NTCQF	22660	POINTLMA	69	0.00	1	SD-IV	San Diego	Aug NQC	QF/Selfgen
SDG&E	SAMPSN_6_KELCO1	22704	SAMPSON	12.5	1.26	1	SD-IV	San Diego	Aug NQC	Net Seller
SDG&E	SLRMS3_2_SRMSR1	23442	DW GEN2 G3A	0.6	40.50	1	SD-IV		Aug NQC	Solar
SDG&E	SLRMS3_2_SRMSR1	23443	DW GEN2 G3B	0.6	27.00	1	SD-IV		Aug NQC	Solar
SDG&E	SMRCOS_6_LNDFIL	22724	SANMRCOS	69	1.50	1	SD-IV	San Diego	Aug NQC	Market
SDG&E	TERMEX_2_PL1X3	22981	TDM STG	21	280.13	1	SD-IV			Market
SDG&E	TERMEX_2_PL1X3	22982	TDM CTG2	18	156.44	1	SD-IV			Market
SDG&E	TERMEX_2_PL1X3	22983	TDM CTG3	18	156.44	1	SD-IV			Market
SDG&E	VLCNTR_6_VCEBT1	23627	VC GEN1_GEN1	34.5	54.00	1	SD-IV	San Diego		Battery
SDG&E	VLCNTR_6_VCEBT2	23628	VC GEN1_GEN2	34.5	50.00	1	SD-IV	San Diego		Battery
SDG&E	VLCNTR_6_VCCLR	22870	VALCNTR	69	0.63	DG	SD-IV	San Diego	Aug NQC	Solar
SDG&E	VLCNTR_6_VCCLR1	22870	VALCNTR	69	0.68	DG	SD-IV	San Diego	Aug NQC	Solar
SDG&E	VLCNTR_6_VCCLR2	22870	VALCNTR	69	1.35	DG	SD-IV	San Diego	Aug NQC	Solar
SDG&E	VSTAES_6_VESBT1	23541	ME GEN 1_BS1	0.64	5.00	1	SD-IV	San Diego		Battery
SDG&E	VSTAES_6_VESBT1	23216	ME GEN 1_BS2	0.48	5.00	1	SD-IV	San Diego		Battery
SDG&E	WISTRA_2_WRSSR1	23287	Q429_G1	0.31	27.00	1	SD-IV		Aug NQC	Solar
SDG&E	ZZ_NA	22916	PFC-AVC	0.6	0.00	1	SD-IV	San Diego	No NQC - hist. data	QF/Selfgen
SDG&E	ZZZ_New Unit	23933	Q1670_ES	0.6	200.00	12	SD-IV	San Diego	No NQC - Pmax	Battery
SDG&E	ZZZ_New Unit	23398	Q1166_G	0.41	174.00	1	SD-IV		No NQC - PCDS	Hybrid
SDG&E	ZZZ_New Unit	23929	Q1669_ES	0.6	100.00	12	SD-IV	San Diego	No NQC - Pmax	Battery
SDG&E	ZZZ_New Unit	22969	Q1532_GEN	0.6	90.00	1	SD-IV	San Diego	No NQC - Pmax	Hybrid
SDG&E	ZZZ_New Unit	23710	Q1170_BESS	0.48	75.00	1	SD-IV	San Diego	No NQC - Pmax	Battery
SDG&E	ZZZ_New Unit	23597	Q1175_BESS	0.48	40.40	1	SD-IV		No NQC - PCDS	Battery

Attachment A - List of physical resources by PTO, local area and market ID

SDG&E	ZZZ_New Unit	22020	AVOCADO	69	40.00	S2	SD-IV	San Diego	No NQC - Pmax	Battery
SDG&E	ZZZ_New Unit	23544	Q1169_BESS1	0.4	34.80	C8	SD-IV	San Diego	No NQC - Pmax	Battery
SDG&E	ZZZ_New Unit	23519	Q1169_BESS2	0.4	34.80	C8	SD-IV	San Diego	No NQC - Pmax	Battery
SDG&E	ZZZ_New Unit	23585	Q838_G1	0.6	13.50	1	SD-IV		No NQC - est. data	Solar
SDG&E	ZZZ_New Unit	23586	Q838_G2	0.6	13.50	1	SD-IV		No NQC - est. data	Solar
SDG&E	ZZZ_New Unit	22942	BUE GEN 1_G1	0.69	11.60	G1	SD-IV		No NQC - est. data	Wind
SDG&E	ZZZ_New Unit	22945	BUE GEN 1_G2	0.69	11.60	G2	SD-IV		No NQC - est. data	Wind
SDG&E	ZZZ_New Unit	22947	BUE GEN 1_G3	0.69	11.60	G3	SD-IV		No NQC - est. data	Wind
SDG&E	ZZZ_New Unit	23231	Q1432_G	0.39	9.20	1	SD-IV	San Diego	No NQC - PCDS	Hybrid
SDG&E	ZZZ_New Unit	22256	ESCNDIDO	69	6.50	S2	SD-IV	San Diego	No NQC - Pmax	Battery
SDG&E	ZZZ_New Unit	22112	CAPSTRNO	138	5.90	1	SD-IV	San Diego	No NQC - Pmax	Battery
SDG&E	ZZZ_New Unit	22112	CAPSTRNO	138	4.00	S2	SD-IV	San Diego	No NQC - Pmax	Battery
SDG&E	ZZZ_New Unit	22949	BUE GEN 1_G4	0.69	0.00	1	SD-IV		Energy Only	Wind
SDG&E	ZZZ_New Unit	23560	Q1047_BESS	0.48	0.00	1	SD-IV	San Diego	Energy Only	Battery
SDG&E	ZZZ_New Unit	22404	LILAC	69	0.00	S2	SD-IV	San Diego	Energy Only	Battery
SDG&E	ZZZ_New Unit	22512	MONSRATE	69	0.00	S2	SD-IV	San Diego	Energy Only	Battery
SDG&E	ZZZZ_New Unit	23959	Q1673_ES1	0.6	300.00	12	SD-IV	San Diego	No NQC - Pmax	Battery
SDG&E	ZZZZ_New Unit	23841	Q1657_ES	0.6	100.00	12	SD-IV	San Diego	No NQC - PCDS	Battery
SDG&E	ZZZZ_New Unit	22484	MIRAMAR1	69	30.00	S2	SD-IV	San Diego	No NQC - Pmax	Battery
SDG&E	ZZZZA_New Unit	230099	PSH G1	13.8	125.00	1	SD-IV	San Diego	No NQC - est. data	Market
SDG&E	ZZZZA_New Unit	230100	PSH G2	13.8	125.00	1	SD-IV	San Diego	No NQC - est. data	Market

Attachment A - List of physical resources by PTO, local area and market ID

SDG&E	ZZZZA_New Unit	230101	PSH G3	13.8	125.00	1	SD-IV	San Diego	No NQC - est. data	Market
SDG&E	ZZZZA_New Unit	230102	PSH G4	13.8	125.00	1	SD-IV	San Diego	No NQC - est. data	Market
SDG&E	ZZZZA_New Unit	23114	ECO W1_G	0.72	32.66	1	SD-IV		No NQC - est. data	Wind
SDG&E	ZZZZA_New Unit	23108	Q159A_GE	0.72	9.14	2	SD-IV		No NQC - est. data	Wind
SDG&E	ZZZZA_New Unit	23108	Q159A_GE	0.72	2.61	3	SD-IV		No NQC - est. data	Wind
SDG&E	ZZZZZ_CBRLLO_6_PLST P1	22092	CABRILLO	69	0.00	1	SD-IV	San Diego	Retired	Market
SDG&E	ZZZZZ_CCRITA_7_RPPC HF	22124	CHCARITA	138	0.00	1	SD-IV	San Diego	Retired	Market

o

## Attachment B – Effectiveness factors for procurement guidance

**Table - Eagle Rock.**

Effectiveness factors to the Eagle Rock-Cortina 115 kV line:

Gen Bus	Gen Name	Gen ID	Eff Fctr (%)
31406	GEYSR5-6	1	36
31406	GEYSR5-6	2	36
31408	GEYSER78	1	36
31408	GEYSER78	2	36
31412	GEYSER11	1	37
31435	GEO.ENGY	1	35
31435	GEO.ENGY	2	35
31433	POTTRVLY	1	34
31433	POTTRVLY	3	34
31433	POTTRVLY	4	34
38020	CITY UKH	1	32
38020	CITY UKH	2	32

**Table - Fulton**

Effectiveness factors to the Lakeville-Petaluma-Cotati 60 kV line:

Gen Bus	Gen Name	Gen ID	Eff Fctr (%)
31466	SONMA LF	1	52
31422	GEYSER17	1	12
31404	WEST FOR	1	12
31404	WEST FOR	2	12
31414	GEYSER12	1	12
31418	GEYSER14	1	12
31420	GEYSER16	1	12
31402	BEAR CAN	1	12
31402	BEAR CAN	2	12
38110	NCPA2GY1	1	12

Attachment B - Effectiveness factors for procurement guidance

Gen Bus	Gen Name	Gen ID	Eff Fctr (%)
38112	NCPA2GY2	1	12
32700	MONTICLO	1	10
32700	MONTICLO	2	10
32700	MONTICLO	3	10
31435	GEO.ENGY	1	6
31435	GEO.ENGY	2	6
31408	GEYSER78	1	6
31408	GEYSER78	2	6
31412	GEYSER11	1	6
31406	GEYSR5-6	1	6
31406	GEYSR5-6	2	6

**Table - Lakeville**

Effectiveness factors to the Vaca Dixon-Lakeville 230 kV line:

Gen Bus	Gen Name	Gen ID	Eff Fctr (%)
31400	SANTA FE	2	38
31430	SMUDGE01	1	38
31400	SANTA FE	1	38
31416	GEYSER13	1	38
31424	GEYSER18	1	38
31426	GEYSER20	1	38
38106	NCPA1GY1	1	38
38108	NCPA1GY2	1	38
31421	BOTTLERK	1	36
31404	WEST FOR	2	36
31402	BEAR CAN	1	36
31402	BEAR CAN	2	36
31404	WEST FOR	1	36
31414	GEYSER12	1	36
31418	GEYSER14	1	36
31420	GEYSER16	1	36
31422	GEYSER17	1	36
38110	NCPA2GY1	1	36

Attachment B - Effectiveness factors for procurement guidance

Gen Bus	Gen Name	Gen ID	Eff Fctr (%)
38112	NCPA2GY2	1	36
31446	SONMA LF	1	36
32700	MONTICLO	1	31
32700	MONTICLO	2	31
32700	MONTICLO	3	31
31406	GEYSR5-6	1	18
31406	GEYSR5-6	2	18
31405	RPSP1014	1	18
31408	GEYSER78	1	18
31408	GEYSER78	2	18
31412	GEYSER11	1	18
31435	GEO.ENGY	1	18
31435	GEO.ENGY	2	18
31433	POTTRVLY	1	15
31433	POTTRVLY	2	15
31433	POTTRVLY	3	15
38020	CITY UKH	1	15
38020	CITY UKH	2	15

**Table – Rio Oso**

Effectiveness factors to the Rio Oso-Atlantic 230 kV line:

Gen Bus	Gen Name	Gen ID	Eff Fctr. (%)
32498	SPILINCF	1	49
32500	ULTR RCK	1	49
32456	MIDLFORK	1	33
32456	MIDLFORK	2	33
32458	RALSTON	1	33
32513	ELDRADO1	1	32
32514	ELDRADO2	1	32
32510	CHILIBAR	1	32

Attachment B - Effectiveness factors for procurement guidance

32486	HELLHOLE	1	31
32508	FRNCH MD	1	30
32460	NEWCSTLE	1	26
32478	HALSEY F	1	24
32512	WISE	1	24
38114	Stig CC	1	14
38123	Q267CT	1	14
38124	Q267ST	1	14
32462	CHI.PARK	1	8
32464	DTCHFLT1	1	4

**Table – South of Table Mountain**

Effectiveness factors to the Caribou-Palermo 115 kV line:

Gen Bus	Gen Name	Gen ID	Eff Fctr. (%)
31814	FORBSTWN	1	7
31794	WOODLEAF	1	7
31832	SLY.CR.	1	7
31862	DEADWOOD	1	7
31890	PO POWER	1	6
31890	PO POWER	2	6
31888	OROVILLE	1	6
31834	KELLYRDG	1	6
32450	COLGATE1	1	4
32466	NARROWS1	1	4
32468	NARROWS2	1	4
32452	COLGATE2	1	4
32470	CMP.FARW	1	4

Attachment B - Effectiveness factors for procurement guidance

<b>Gen Bus</b>	<b>Gen Name</b>	<b>Gen ID</b>	<b>Eff Fctr. (%)</b>
32451	FREC	1	4
32490	GRNLEAF1	1	4
32490	GRNLEAF1	2	4
32496	YCEC	1	4
32494	YUBA CTY	1	4
32492	GRNLEAF2	1	4
32498	SPILINCF	1	2
31788	ROCK CK2	1	2
31812	CRESTA	1	2
31812	CRESTA	2	2
31820	BCKS CRK	1	2
31820	BCKS CRK	2	2
31786	ROCK CK1	1	2
31790	POE 1	1	2
31792	POE 2	1	2
31784	BELDEN	1	2
32500	ULTR RCK	1	2
32156	WOODLAND	1	2
32510	CHILIBAR	1	2
32513	ELDRADO1	1	2
32514	ELDRADO2	1	2
32478	HALSEY F	1	2
32460	NEWCASTLE	1	1
32458	RALSTON	1	1
32512	WISE	1	1
32456	MIDLFORK	1	1
32456	MIDLFORK	2	1



Attachment B - Effectiveness factors for procurement guidance

Gen Bus	Gen Name	Gen ID	Eff Fctr. (%)
32486	HELLHOLE	1	1
32508	FRNCH MD	1	1
32162	RIV.DLTA	1	1
32502	DTCHFLT2	1	1
32462	CHI.PARK	1	1
32464	DTCHFLT1	1	1
32454	DRUM 5	1	1
32476	ROLLINSF	1	1
32484	OXBOW F	1	1
32474	DEER CRK	1	1
32504	DRUM 1-2	1	1
32504	DRUM 1-2	2	1
32506	DRUM 3-4	1	1
32506	DRUM 3-4	2	1
32166	UC DAVIS	1	1
32472	SPAULDG	1	1
32472	SPAULDG	2	1
32472	SPAULDG	3	1
32480	BOWMAN	1	1
32488	HAYPRES+	1	1
32488	HAYPRES+	2	1
38124	LODI ST1	1	1
38123	LODI CT1	1	1
38114	STIG CC	1	1

**Table – San Jose**

Effectiveness factors to the Newark-NRS 115 kV line:

Attachment B - Effectiveness factors for procurement guidance

Gen Bus	Gen Name	Gen ID	Eff Fctr (%)
36895	Gia200	1	25
36858	Gia100	1	25
36859	Laf300	2	23
36859	Laf300	1	23
36863	DVRaGT1	1	23
36864	DVRbGt2	1	23
36865	DVRaST3	1	23
35854	LECEFGT1	1	19
35855	LECEFGT2	1	19
35856	LECEFGT3	1	19
35857	LECEFGT4	1	19
35858	LECEFST1	1	19
35860	OLS-AGNE	1	19
35863	CATALYST	1	12

**Table – South Bay-Moss Landing**

Effectiveness factors to the Moss Landing-Las Aguillas 230 kV line:

Gen Bus	Gen Name	Gen ID	Eff Fctr. (%)
36209	SLD ENRG	1	20
36221	DUKMOSS1	1	20
36222	DUKMOSS2	1	20
36223	DUKMOSS3	1	20
36224	DUKMOSS4	1	20
36225	DUKMOSS5	1	20
36226	DUKMOSS6	1	20
36405	MOSSLND6	1	17
36406	MOSSLND7	1	17
35881	MEC CTG1	1	13
35882	MEC CTG2	1	13

Attachment B - Effectiveness factors for procurement guidance

35883	MEC STG1	1	13
35850	GLRY COG	1	12
35850	GLRY COG	2	12
35851	GROYPKR1	1	12
35852	GROYPKR2	1	12
35853	GROYPKR3	1	12
35623	SWIFT	BT	10
35863	CATALYST	1	10
36863	DVRaGT1	1	8
36864	DVRbGt2	1	8
36865	DVRaST3	1	8
36859	Laf300	2	8
36859	Laf300	1	8
36858	Gia100	1	7
36895	Gia200	1	7
35854	LECEFGT1	1	7
35855	LECEFGT2	1	7
35856	LECEFGT3	1	7
35857	LECEFGT4	1	7
35858	LECEFST1	1	7
35860	OLS-AGNE	1	7

**Table – Ames/Pittsburg/Oakland**

Effectiveness factors to the Ames-Ravenswood #1 115 kV line:

Gen Bus	Gen Name	Gen ID	Eff Fctr. (%)
35304	RUSELCT1	1	10

Attachment B - Effectiveness factors for procurement guidance

35305	RUSELCT2	2	10
35306	RUSELST1	3	10
33469	OX_MTN	1	10
33469	OX_MTN	2	10
33469	OX_MTN	3	10
33469	OX_MTN	4	10
33469	OX_MTN	5	10
33469	OX_MTN	6	10
33469	OX_MTN	7	10
33107	DEC STG1	1	3
33108	DEC CTG1	1	3
33109	DEC CTG2	1	3
33110	DEC CTG3	1	3
33102	COLUMBIA	1	3
33111	LMECCT2	1	3
33112	LMECCT1	1	3
33113	LMECST1	1	3
33151	FOSTER W	1	2
33151	FOSTER W	2	2
33151	FOSTER W	3	2
33136	CCCSD	1	2
33141	SHELL 1	1	2
33142	SHELL 2	1	2
33143	SHELL 3	1	2
32900	CRCKTCOG	1	2
32910	UNOCAL	1	2
32910	UNOCAL	2	2

Attachment B - Effectiveness factors for procurement guidance

32910	UNOCAL	3	2
32920	UNION CH	1	2
32921	ChevGen1	1	2
32922	ChevGen2	1	2
32923	ChevGen3	3	2
32741	HILLSIDE_12	1	2
32901	OAKLND 1	1	1
32902	OAKLND 2	2	1
32903	OAKLND 3	3	1
38118	ALMDACT1	1	1
38119	ALMDACT2	1	1

Effectiveness factors to the Moraga-Claremont #2 115 kV line:

<b>Gen Bus</b>	<b>Gen Name</b>	<b>Gen ID</b>	<b>Eff Fctr. (%)</b>
32741	HILLSIDE_12	1	15
32921	ChevGen1	1	15
32922	ChevGen2	1	15
32923	ChevGen3	3	15
32920	UNION CH	1	14
32910	UNOCAL	1	13
32910	UNOCAL	2	13
32910	UNOCAL	3	13
32901	OAKLND 1	1	10
32902	OAKLND 2	2	10
32903	OAKLND 3	3	10
38118	ALMDACT1	1	10

Attachment B - Effectiveness factors for procurement guidance

38119	ALMDACT2	1	10
33141	SHELL 1	1	9
33142	SHELL 2	1	9
33143	SHELL 3	1	9
33136	CCCSD	1	8
32900	CRCKTCOG	1	7
33151	FOSTER W	1	6
33151	FOSTER W	2	6
33151	FOSTER W	3	6
33102	COLUMBIA	1	3
33111	LMECCT2	1	3
33112	LMECCT1	1	3
33113	LMECST1	1	3
33107	DEC STG1	1	3
33108	DEC CTG1	1	3
33109	DEC CTG2	1	3
33110	DEC CTG3	1	3

**Table – Herndon**

Effectiveness factors to the Herndon-Manchester 115 kV line:

Gen Bus	Gen Name	Gen ID	Eff Fctr. (%)
34624	BALCH 1	1	22
34616	KINGSRIV	1	21
34648	DINUBA E	1	20
34671	KRCDPCT1	1	19
34672	KRCDPCT2	1	19

Attachment B - Effectiveness factors for procurement guidance

34308	KERCKHOF	1	17
34343	KERCK1-2	2	17
34344	KERCK1-1	1	17
34345	KERCK1-3	3	17
34603	JGBSWLT	ST	15
34677	Q558	1	15
34690	CORCORAN_3	FW	15
34692	CORCORAN_4	FW	15
34696	CORCORANPV_S	1	15
34699	Q529	1	15
34610	HAAS	1	13
34610	HAAS	2	13
34612	BLCH 2-2	1	13
34614	BLCH 2-3	1	13
34431	GWF_HEP1	1	8
34433	GWF_HEP2	1	8
34617	Q581	1	5
34649	Q965	1	5
34680	KANSAS	1	5
34467	GIFFEN_DIST	1	4
34563	STROUD_DIST	2	4
34563	STROUD_DIST	1	4
34608	AGRICO	2	4
34608	AGRICO	3	4
34608	AGRICO	4	4
34644	Q679	1	4
36550	Q632BC1	1	4

Attachment B - Effectiveness factors for procurement guidance

**Table – LA Basin**

Effectiveness factors to the Mesa – Laguna Bell #1 230 kV line:

Gen Bus	Gen Name	Gen ID	Eff Fctr. (%)
29951	REFUSE	D1	35
24239	MALBRG1G	C1	34
24240	MALBRG1G	C2	34
24241	MALBRG1G	S3	34
29903	ELSEG6ST	6	27
29904	ELSEG5GT	5	27
29902	ELSEG7ST	7	27
29901	ELSEG8GT	8	27
24337	VENICE	1	26
24094	MOBGEN1	1	26
24329	MOBGEN2	1	26
24332	PALOGEN	D1	26
24011	ARCO 1G	1	23
24012	ARCO 2G	2	23
24013	ARCO 3G	3	23
24014	ARCO 4G	4	23
24163	ARCO 5G	5	23
24164	ARCO 6G	6	23
24062	HARBOR G	1	23
24062	HARBOR G	HP	23
25510	HARBORG4	LP	23
24327	THUMSGEN	1	23



Attachment B - Effectiveness factors for procurement guidance

24020	CARBGEN1	1	23
24328	CARBGEN2	1	23
24139	SERRFGEN	D1	23
24070	ICEGEN	1	22
24001	ALAMT1 G	1	18
24002	ALAMT2 G	2	18
24003	ALAMT3 G	3	18
24004	ALAMT4 G	4	18
24005	ALAMT5 G	5	18
24161	ALAMT6 G	6	18
90000	ALMT-GT1	X1	18
90001	ALMT-GT2	X2	18
90002	ALMT-ST1	X3	18
29308	CTRPKGEN	1	18
29953	SIGGEN	D1	18
29309	BARPKGEN	1	13
29201	WALCRKG1	1	12
29202	WALCRKG2	1	12
29203	WALCRKG3	1	12
29204	WALCRKG4	1	12
29205	WALCRKG5	1	12
29011	BREAPWR2	C1	12
29011	BREAPWR2	C2	12
29011	BREAPWR2	C3	12
29011	BREAPWR2	C4	12
29011	BREAPWR2	S1	12
24325	ORCOGEN	1	12

Attachment B - Effectiveness factors for procurement guidance

24341	COYGEN	I	11
25192	WDT1406_G	I	11
25208	DowlingCTG	1	10
25211	CanyonGT 1	1	10
25212	CanyonGT 2	2	10
25213	CanyonGT 3	3	10
25214	CanyonGT 4	4	10
24216	VILLA PK	DG	9

**Table – Rector**

Effectiveness factors to the Rector-Vestal 230 kV line:

Gen Bus	Gen Name	Gen ID	MW Eff Fctr (%)
24370	KAWGEN	1	51
24306	B CRK1-1	1	45
24306	B CRK1-1	2	45
24307	B CRK1-2	3	45
24307	B CRK1-2	4	45
24319	EASTWOOD	1	45
24323	PORTAL	1	45
24308	B CRK2-1	1	45
24308	B CRK2-1	2	45
24309	B CRK2-2	3	45
24309	B CRK2-2	4	45
24310	B CRK2-3	5	45
24310	B CRK2-3	6	45
24315	B CRK 8	81	45
24315	B CRK 8	82	45
24311	B CRK3-1	1	45

Attachment B - Effectiveness factors for procurement guidance

24311	B CRK3-1	2	45
24312	B CRK3-2	3	45
24312	B CRK3-2	4	45
24313	B CRK3-3	5	45
24317	MAMOTH1G	1	45
24318	MAMOTH2G	2	45
24314	B CRK 4	41	43
24314	B CRK 4	42	43

**Table – San Diego**

Effectiveness factors to the Imperial Valley – El Centro 230 kV line (i.e., the “S” line):

Gen Bus	Gen Name	Gen ID	Eff Fctr. (%)
22982	TDM CTG2	1	25
22983	TDM CTG3	1	25
22981	TDM STG	1	25
22997	INTBCT	1	25
22996	INTBST	1	25
23440	DW GEN2 G1	1	25
23298	DW GEN1 G1	G1	25
23156	DU GEN1 G2	G2	25
23299	DW GEN1 G2	G2	25
23155	DU GEN1 G1	G1	25
23441	DW GEN2 G2	1	25
23442	DW GEN2 G3A	1	25
23443	DW GEN2 G3B	1	25
23314	OCO GEN G1	G1	23
23318	OCO GEN G2	G2	23

Attachment B - Effectiveness factors for procurement guidance

23100	ECO GEN1 G	G1	22
23352	ECO GEN2 G	1	21
22605	OTAYMGT1	1	18
22606	OTAYMGT2	1	18
22607	OTAYMST1	1	18
23162	PIO PICO CT1	1	18
23163	PIO PICO CT2	1	18
23164	PIO PICO CT3	1	18
22915	KUMEYAAY	1	17
23320	EC GEN2	1	17
22150	EC GEN1	1	17
22617	OY GEN	1	17
22604	OTAY	1	17
22604	OTAY	3	17
22172	DIVISION	1	17
22576	NOISLMTR	1	17
22704	SAMPSON	1	17
22092	CABRILLO	1	17
22074	LRKSPBD1	1	17
22075	LRKSPBD2	1	17
22660	POINTLMA	1	17
22660	POINTLMA	2	17
22149	CALPK_BD	1	17
22448	MESAHGTS	1	16
22120	CARLTNHS	1	16
22120	CARLTNHS	2	16
22496	MISSION	1	16

Attachment B - Effectiveness factors for procurement guidance

22486	MEF MR1	1	16
22124	CHCARITA	1	16
22487	MEF MR2	1	16
22625	LkHodG1	1	16
22626	LkHodG2	2	16
22332	GOALLINE	1	15
22262	PEN_CT1	1	15
22153	CALPK_ES	1	15
22786	EA GEN1 U6	1	15
22787	EA GEN1 U7	1	15
22783	EA GEN1 U8	1	15
22784	EA GEN1 U9	1	15
22789	EA GEN1 U10	1	15
22257	ES GEN	1	15
22263	PEN_CT2	1	15
22265	PEN_ST	1	15
22724	SANMRCOS	1	15
22628	PA GEN1	1	14
22629	PA GEN2	1	14
22082	BR GEN1	1	14
22112	CAPSTRNO	1	12