

APPENDIX G: 2030 LOCAL CAPACITY TECHNICAL STUDY

Executive Summary

This report documents the results of the 2030 Long-Term Local Capacity Technical (LCT) Study. The LCT Study objectives, inputs, methodologies and assumptions are the same as those discussed in the 2021 LCT Study to be adopted by the CAISO and submitted to the CPUC for adoption in its 2021 Local Resource Adequacy process.

Overall, the Local Capacity area resource Requirements (LCR) trend compared with 2025, is up by about 2140 MW or about 9.7%. It is worth mentioning the following areas: (1) LA Basin where LCR has decreased mostly due to reduction in imports from South-West; (2) Bay Area where LCR has increased mostly due to load forecast increase as well as increase in S-N flow on Path 15; (3) North Coast/North Bay where LCR has increased mostly due to change in limiting contingency and equipment; (4) Sierra, Stockton, Fresno, Big Creek/Ventura and San Diego/Imperial Valley where LCR has increased mainly due to load forecast increase; (5) Kern where LCR has increased mainly due to definition change triggered by removal of a previously approved transmission project; (6) Humboldt, where LCR needs are steady.

The load forecast used in this study is based on the final adopted California Energy Demand 2020-2030 Revised Forecast, developed by the CEC; namely the load-serving entity (LSE) and balancing authority (BA) mid baseline demand with low additional achievable energy efficiency and photo voltaic (AEE-AAPV), posted on 3/4/2020: <https://efiling.energy.ca.gov/GetDocument.aspx?tn=232305&DocumentContentId=64305>.

The 2030 and 2028 total LCR needs are provided below for comparison:

2030 Local Capacity Needs

Local Area Name	Qualifying Capacity				Capacity Available at Peak	2030 LCR Need Category C
	QF/Muni (MW)	Non-Solar (MW)	Solar (MW)	Total (MW)	Total (MW)	Capacity Needed
Humboldt	0	191	0	191	191	135
North Coast/ North Bay	119	723	0	842	842	842*
Sierra	1183	920	5	2108	2103	1518*
Stockton	116	491	12	619	607	619*
Greater Bay	604	6732	8	7344	7344	7344*
Greater Fresno	216	2815	361	3392	3191	2296*
Kern	5	330	78	413	335	413*
Big Creek/ Ventura	424	3220	250	3894	3644	1151
LA Basin	1197	6187	11	7395	7261	6194
San Diego/ Imperial Valley	2	4438	378	4818	4440	3718

Total	3866	26047	1103	31016	29958	24230
--------------	-------------	--------------	-------------	--------------	--------------	--------------

2025 Local Capacity Needs

Local Area Name	Qualifying Capacity				Capacity Available at Peak	2025 LCR Need Category C
	QF/ Muni (MW)	Non-Solar (MW)	Solar (MW)	Total (MW)	Total (MW)	Capacity Needed
Humboldt	0	191	0	191	191	132
North Coast/ North Bay	119	723	0	842	842	837
Sierra	1183	920	5	2108	2103	1367*
Stockton	116	491	12	619	607	619*
Greater Bay	604	6732	8	7344	7344	6110*
Greater Fresno	216	2815	361	3392	3191	1971*
Kern	5	330	78	413	335	186*
Big Creek/ Ventura	424	2963	250	3637	3637	1002
LA Basin	1197	6215	11	7423	7423	6309
San Diego/ Imperial Valley	2	4438	378	4818	4440	3557
Total	3866	25818	1103	30787	30113	22090

* Details about magnitude of deficiencies can be found in the applicable section below. Resource deficient sub-area implies that in order to comply with the criteria, at summer peak, load may be shed immediately after the first contingency.

The narrative for each Local Capacity Area lists important new projects included in the base cases as well as a description of reason for changes between the 2025 Long-Term LCT study and this 2030 Long-Term LCT study.

This 2030 Long-Term Local Capacity Technical (LCT) Study was prepared in keeping with the ISO's current commitment to prepare biennial 10-year local capacity technical studies on an informational basis, to assist with the CPUC's Integrated Resource Planning process.

This 10-year study is the first prepared by the ISO that provides stakeholders with comprehensive load profile and transmission capacity profile information to provide additional insight into the nature of the local capacity needs additional information to understand the nature. As well, in keeping with the stated intent in the 2020-2021 transmission planning process, the ISO has explored and identified alternatives for reducing reliance on local gas-fired generation capacity in at least half of the areas and sub-areas. Several of these alternatives were transitioned to the ISO's economic study phase in this transmission planning cycle for further consideration as potential economic-driven transmission solutions.

Table of Contents

Executive Summary	3
1 Overview of the Study: Inputs, Outputs and Options.....	7
1.1 Objectives	7
1.2 Key Study Assumptions	7
1.2.1 Inputs and Methodology	7
1.3 Grid Reliability	9
1.4 Application of N-1, N-1-1, and N-2 Criteria	10
1.5 Performance Criteria	10
1.5.1 Performance Criteria	10
1.5.2 CAISO Statutory Obligation Regarding Safe Operation	11
2 Assumption Details: How the Study was Conducted.....	15
2.1 System Planning Criteria.....	15
2.1.1 Power Flow Assessment:	18
2.1.2 Post Transient Load Flow Assessment:.....	19
2.1.3 Stability Assessment:	19
2.2 Load Forecast	20
2.2.1 System Forecast	20
2.2.2 Base Case Load Development Method	20
2.3 Power Flow Program Used in the LCR analysis	21
2.4 Estimate of Battery Storage Needs due to Charging Constraints	21
3 Locational Capacity Requirement Study Results	23
3.5 Summary of Study Results	23
3.6 Summary of Results by Local Area	27
3.6.1 Humboldt Area	27
3.6.2 North Coast / North Bay Area.....	31
3.6.3 Sierra Area	39
3.6.4 Stockton Area.....	47
3.6.5 Greater Bay Area	55
3.6.6 Greater Fresno Area	77
3.6.7 Kern Area	98
3.6.8 Big Creek/Ventura Area.....	114
3.6.9 LA Basin Area	126
3.6.10 San Diego-Imperial Valley Area.....	145
3.6.11 Valley Electric Area	160
Attachment A – List of physical resources by PTO, local area and market ID	161
Attachment B – Effectiveness factors for procurement guidance.....	209

Intentionally left blank

1 Overview of the Study: Inputs, Outputs and Options

1.1 Objectives

The intent of the 2030 Long-Term LCT Study is to identify specific areas within the CAISO Balancing Authority Area that have limited import capability and determine the minimum generation capacity (MW) necessary to mitigate the local reliability problems in those areas, as was the objective of all previous Local Capacity Technical Studies.

This 2030 Long-Term Local Capacity Technical (LCT) Study was prepared in keeping with the ISO's current commitment to prepare biennial 10-year local capacity technical studies on an informational basis, to assist with the CPUC's Integrated Resource Planning processes.

This 10-year study goes beyond the scope of previous 10-year local capacity technical studies and is the first prepared by the ISO that provides stakeholders with comprehensive load profile and transmission capacity profile information to provide additional insight into the nature of the local capacity needs additional information to understand the nature. As well, in keeping with the stated intent in the 2020-2021 transmission planning process, the ISO has explored and identified alternatives for reducing reliance on local gas-fired generation capacity. Several of these alternatives were transitioned to the ISO's economic study phase in this transmission planning cycle for further consideration as potential economic-driven transmission solutions.

1.2 Key Study Assumptions

1.2.1 Inputs and Methodology

The CAISO used the same Inputs and Methodology as agreed upon by interested parties and previously incorporated into the 2021 LCT Study. The following table sets forth a summary of the approved inputs and methodology that have been used in the 2021 LCT Study as well as this 2030 LCT Study:

Table 1.2-1 Summary Table of Inputs and Methodology Used in this LCT Study:

Issue	How Incorporated into THIS LCT Study:
Input Assumptions:	
Transmission System Configuration	The existing transmission system has been modeled, including all projects operational on or before June 1, of the study year and all other feasible operational solutions brought forth by the PTOs and as agreed to by the CAISO.
Generation Modeled	The existing generation resources has been modeled and also includes all projects that will be on-line and commercial on or before June 1, of the study year
Load Forecast	Uses a 1-in-10 year summer peak load forecast
Methodology:	
Maximize Import Capability	Import capability into the load pocket has been maximized, thus minimizing the generation required in the load pocket to meet applicable reliability requirements.
QF/Nuclear/State/Federal Units	Regulatory Must-take and similarly situated units like QF/Nuclear/State/Federal resources have been modeled on-line at qualifying capacity output values for purposes of this LCT Study.
Maintaining Path Flows	Path flows have been maintained below all established path ratings into the load pockets, including the 500 kV. For clarification, given the existing transmission system configuration, the only 500 kV path that flows directly into a load pocket and will, therefore, be considered in this LCT Study is the South of Lugo transfer path flowing into the LA Basin.

Performance Criteria:	
All Performance Levels, including incorporation of PTO operational solutions	This LCT Study is being published based on the most stringent of all mandatory reliability standards. In addition, the CAISO will incorporate all new projects and other feasible and CAISO-approved operational solutions brought forth by the PTOs that can be operational on or before June 1, of the study year. Any such solutions that can reduce the need for procurement to meet the mandatory standards will be incorporated into the LCT Study.
Load Pocket:	
Fixed Boundary, including limited reference to published effectiveness factors	This LCT Study has been produced based on load pockets defined by a fixed boundary. The CAISO only publishes effectiveness factors where they are useful in facilitating procurement where excess capacity exists within a load pocket.

Further details regarding the 2021 as well as 2030 LCT Study methodology and assumptions are provided in Section III, below.

1.3 Grid Reliability

Service reliability builds from grid reliability because grid reliability is reflected in the Reliability Standards of the North American Electric Reliability Council (NERC) and the Western Electricity Coordinating Council (“WECC”) Regional Criteria (collectively “Reliability Standards”). The Reliability Standards apply to the interconnected electric system in the United States and are intended to address the reality that within an integrated network, whatever one Balancing Authority Area does can affect the reliability of other Balancing Authority Areas. Consistent with the mandatory nature of the Reliability Standards, the CAISO is under a statutory obligation to ensure efficient use and reliable operation of the transmission grid consistent with achievement of the Reliability Standards.¹ The CAISO is further under an obligation, pursuant to its FERC-approved Transmission Control Agreement, to secure compliance with all “Applicable Reliability Criteria.” Applicable Reliability Criteria consists of the Reliability Standards as well as reliability criteria adopted by the CAISO (Grid Planning Standards).

¹ Pub. Utilities Code § 345

The Reliability Standards define reliability on interconnected electric systems using the terms “adequacy” and “security.” “Adequacy” is the ability of the electric systems to supply the aggregate electrical demand and energy requirements of their customers at all times, taking into account physical characteristics of the transmission system such as transmission ratings and scheduled and reasonably expected unscheduled outages of system elements. “Security” is the ability of the electric systems to withstand sudden disturbances such as electric short circuits or unanticipated loss of system elements. The Reliability Standards are organized by Performance Categories. Certain categories require that the grid operator not only ensure that grid integrity is maintained under certain adverse system conditions (e.g., security), but also that all customers continue to receive electric supply to meet demand (e.g., adequacy). In that case, grid reliability and service reliability would overlap. But there are other levels of performance where security can be maintained without ensuring adequacy.

1.4 Application of N-1, N-1-1, and N-2 Criteria

The CAISO will maintain the system in a safe operating mode at all times. This obligation translates into respecting the Reliability Criteria at all times, for example during normal operating conditions (N-0) the CAISO must protect for all single contingencies (N-1) and common mode (N-2) double line outages. Also, after a single contingency, the CAISO must re-adjust the system to support the loss of the next most stringent contingency. This is referred to as the N-1-1 condition.

The N-1-1 vs N-2 terminology was introduced only as a temporal differentiation between two existing NERC Category P6 and P7 events. N-1-1 represents NERC Category C6 (“category P1 contingency, manual system adjustment, followed by another category P1 contingency”). The N-2 represents NERC Category P7 (“any two circuits of a multiple circuit tower line”) as well as WECC-S2 (for 500 kV only) (“any two circuits in the same right-of-way”) with no manual system adjustment between the two contingencies.

1.5 Performance Criteria

As set forth on the Summary Table of Inputs and Methodology, this LCR Report is based on the most stringent mandatory standard (NERC, WECC or CAISO). The CAISO tests the electric system in regards to thermal overloads as well as dynamic and reactive margin compliance with the existing standards.

1.5.1 Performance Criteria

Category P0, P1 & P3 system performance requires that all thermal and voltage limits must be within their “Applicable Rating,” which, in this case, are the emergency ratings as generally determined by the PTO or facility owner. Applicable Rating includes a temporal element such that emergency ratings can only be maintained for certain duration. Under this category, load cannot be shed in order to assure the Applicable Ratings are met however there is no guarantee that facilities are returned to within normal ratings or to a state where it is safe to continue to

operate the system in a reliable manner such that the next element out will not cause a violation of the Applicable Ratings.

The NERC Planning Standards require system operators to “look forward” to make sure they safely prepare for the “next” N-1 following the loss of the “first” N-1 (stay within Applicable Ratings after the “next” N-1). This is commonly referred to as N-1-1. Because it is assumed that some time exists between the “first” and “next” element losses, operating personnel may make any reasonable and feasible adjustments to the system to prepare for the loss of the second element, including, operating procedures, dispatching generation, moving load from one substation to another to reduce equipment loading, dispatching operating personnel to specific station locations to manually adjust load from the substation site, or installing a “Special Protection Scheme” that would remove pre-identified load from service upon the loss of the “next “ element.² All Category P2, P4, P5, P6, P7 and extreme event requirements in this report refer to situations when in real time (N-0) or after the first contingency (N-1) the system requires additional readjustment in order to prepare for the next worst contingency. In this time frame, load drop is not allowed per existing planning criteria.

Generally, Category P2, P4, P5, P6, P7 and extreme event describes system performance that is expected following the loss of two or more system elements. This loss of two elements is generally expected to happen simultaneously, referred to as N-2. It should be noted that once the “next” element is lost after the first contingency, as discussed above under the Performance Criteria P1, the event is effectively a Category P6 or N-1-1 scenario. As noted above, depending on system design and expected system impacts, the **planned and controlled** interruption of supply to customers (load shedding), the removal from service of certain generators and curtailment of exports may be utilized to maintain grid “security.”

1.5.2 CAISO Statutory Obligation Regarding Safe Operation

The ISO must maintain the system in a safe operating mode at all times. This obligation translates into respecting the Reliability Criteria at all times. For example, during normal operating conditions (8760 hours per year), the ISO must protect for all single contingencies (P1, P2) and multiple contingencies (P4, P5) as well as common mode double line outages (P7). As a further example, after a single contingency, the ISO must readjust the system in order to be able to support the loss of the next most stringent contingency (P3 , P6 and P1+P7 resulting in potential voltage collapse or dynamic instability).

Figure 1.5-1 Temporal graph of LCR Category P0-P7

² A Special Protection Scheme is typically proposed as an operational solution that does not require additional generation and permits operators to effectively prepare for the next event as well as ensure security should the next event occur. However, these systems have their own risks, which limit the extent to which they could be deployed as a solution for grid reliability augmentation. While they provide the value of protecting against the next event without the need for pre-contingency load shedding, they add points of potential failure to the transmission network. This increases the potential for load interruptions because sometimes these systems will operate when not required and other times they will not operate when needed.

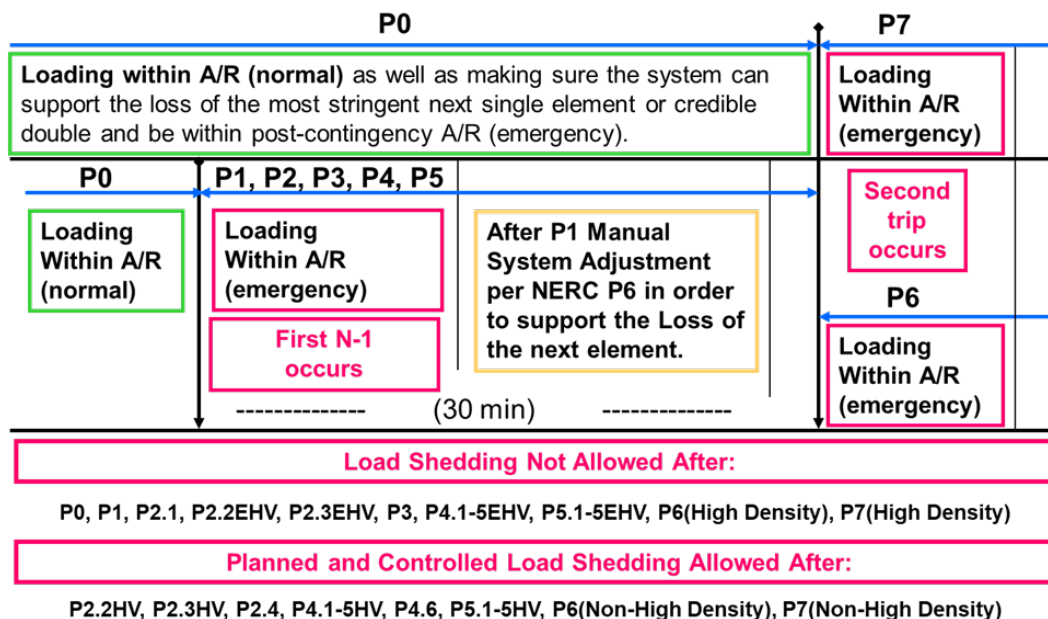

The following definitions guide the CAISO’s interpretation of the Reliability Criteria governing safe mode operation and are used in this LCT Study:

Applicable Rating:

This represents the equipment rating that will be used under certain contingency conditions.

Normal rating is to be used under normal conditions.

Long-term emergency ratings, if available, will be used in all emergency conditions as long as “system readjustment” is provided in the amount of time given (specific to each element) to reduce the flow to within the normal ratings. If not available, the normal rating is to be used.

Short-term emergency ratings, if available, can be used as long as “system readjustment” is provided in the “short-time” available in order to reduce the flow to within the long-term emergency ratings where the element can be kept for another length of time (specific to each element) before the flow needs to be reduced the below the normal ratings. If not available long-term emergency rating should be used.

Temperature-adjusted ratings shall not be used because this is a year-ahead study, not a real-time tool, and as such the worst-case scenario must be covered. In case temperature-adjusted ratings are the only ratings available then the minimum rating (highest temperature) given the study conditions shall be used.

CAISO Transmission Register is the only official keeper of all existing ratings mentioned above.

Ratings for future projects provided by PTO and agreed upon by the CAISO shall be used.

Other short-term ratings not included in the CAISO Transmission Register may be used as long as they are engineered, studied and enforced through clear operating procedures that can be followed by real-time operators.

Path Ratings need to be maintained within their limits in order to assure that proper capacity is available in order to operate the system in real-time in a safe operating zone.

Controlled load drop:

This is achieved with the use of a Special Protection Scheme.

Planned load drop:

This is achieved when the most limiting equipment has short-term emergency ratings AND the operators have an operating procedure that clearly describes the actions that need to be taken in order to shed load.

Special Protection Scheme:

All known SPS shall be assumed. New SPS must be verified and approved by the CAISO and must comply with the new SPS guideline described in the CAISO Planning Standards.

System Readjustment:

This represents the actions taken by operators in order to bring the system within a safe operating zone after any given contingency in the system.

Actions that can be taken as system readjustment after a Category P1, P2.1, P2.2(EHV), P2.3(EHV), P3, P4.1-5(EHV), P5.1-5(EHV), P6(high density area)&P7(high density area) contingency:

1. System configuration change – based on validated and approved operating procedures
2. Generation re-dispatch
 - a. Decrease generation (up to 1150 MW) – limit given by single contingency SPS as part of the ISO Grid Planning standards (ISO SPS3)
 - b. Increase generation – this generation will become part of the LCR need

Actions, which shall not be taken as system readjustment after a Category P1, P2.1, P2.2(EHV), P2.3(EHV), P3, P4.1-5(EHV), P5.1-5(EHV), P6(high density area)&P7(high density area) contingency:

1. Load drop – based on the intent of the ISO/WECC and NERC criteria for category P1 contingencies.

An objective of the planning process is to minimize the likelihood and magnitude of Non-Consequential Load Loss following Contingency events. NERC and ISO Planning standards mandate that no load shedding should be done immediately after a Category P1, P2.1,

P2.2(EHV), P2.3(EHV), P3, P4.1-5(EHV), P5.1-5(EHV), P6(high density area)&P7(high density area) contingency. The system should be planned with no load shedding regardless of when it may occur (immediately or within 15-30 minutes after the first contingency). It follows that load shedding may not be utilized as part of the system readjustment period – in order to protect for the next most limiting contingency. Therefore, if there are available resources in the local area, such resources should be used during the manual adjustment period (and included in the LCR need) before resorting to shedding firm load.

Firm load shedding is allowed in a planned and controlled manner after the first contingency in P2.2(HV), P2.3(HV), P2.4, P4.1-5(HV), P4.6, P5.1-5(HV) and after the second contingency in P6(non-high density area), P7(non-high density area) & P1 system adjusted followed by P7 category events.

This interpretation tends to guarantee that firm load shedding is used to address Category P1, P2.1, P2.2(EHV), P2.3(EHV), P3, P4.1-5(EHV), P5.1-5(EHV), P6(high density area)&P7(high density area) conditions only under the limited circumstances where no other resource or validated operational measure is available. A contrary interpretation would constitute a departure from existing practice and degrade current service expectations by increasing load's exposure to service interruptions.

Time allowed for manual readjustment:

Tariff Section 40.3.1.1, requires the CAISO, in performing the Local Capacity Technical Study, to apply the following reliability criterion:

Time Allowed for Manual Adjustment: This is the amount of time required for the Operator to take all actions necessary to prepare the system for the next Contingency. The time should not be more than thirty (30) minutes.

The CAISO Planning Standards also impose this manual readjustment requirement. As a parameter of the Local Capacity Technical Study, the CAISO must assume that as the system operator the CAISO will have sufficient time to:

- (1) make an informed assessment of system conditions after a contingency has occurred;
- (2) identify available resources and make prudent decisions about the most effective system redispatch;
- (3) manually readjust the system within safe operating limits after a first contingency to be prepared for the next contingency; and
- (4) allow sufficient time for resources to ramp and respond according to the operator's redispatch instructions. This all must be accomplished within 30 minutes.

Local capacity resources can meet this requirement by either (1) responding with sufficient speed, allowing the operator the necessary time to assess and redispatch resources to effectively reposition the system within 30 minutes after the first contingency, or (2) have sufficient energy available for frequent dispatch on a pre-contingency basis to ensure the operator can meet minimum online commitment constraints or reposition the system within 30 minutes after the first contingency occurs. Accordingly, when evaluating resources that satisfy the requirements of the CAISO Local Capacity Technical Study, the CAISO assumes that local capacity resources need to be available in no longer than 20 minutes so the CAISO and demand response providers have a reasonable opportunity to perform their respective and necessary tasks and enable the CAISO to reposition the system within the 30 minutes in accordance with applicable reliability criteria.

2 Assumption Details: How the Study was Conducted

2.1 System Planning Criteria

The following table provides a comparison of system planning criteria, based on the NERC performance standards, used in the study:

Table 2.1-1: Criteria Comparison for Bulk Electric System contingencies

Contingency Component(s)	Mandatory Reliability Standards	Old Local Capacity Criteria	New Local Capacity Criteria
<u>P0 – No Contingencies</u>	X	X	X
<u>P1 – Single Contingency</u>			
1. Generator (G-1)	X	X ¹	X ¹
2. Transmission Circuit (L-1)	X	X ¹	X ¹
3. Transformer (T-1)	X	X ^{1,2}	X ¹
4. Shunt Device	X		X ¹
5. Single Pole (dc) Line	X	X ¹	X ¹
<u>P2 – Single contingency</u>			
1. Opening a line section w/o a fault	X		X
2. Bus Section fault	X		X
3. Internal Breaker fault (non-Bus-tie Breaker)	X		X
4. Internal Breaker fault (Bus-tie Breaker)	X		X
<u>P3 – Multiple Contingency – G-1 + system adjustment and:</u>			
1. Generator (G-1)	X	X	X
2. Transmission Circuit (L-1)	X	X	X
3. Transformer (T-1)	X	X ²	X
4. Shunt Device	X		X
5. Single Pole (dc) Line	X	X	X

<u>P4 – Multiple Contingency - Fault plus stuck breaker</u>			
1. Generator (G-1)	X		X
2. Transmission Circuit (L-1)	X		X
3. Transformer (T-1)	X		X
4. Shunt Device	X		X
5. Bus section	X		X
6. Bus-tie breaker	X		X
<u>P5 – Multiple Contingency – Relay failure (delayed clearing)</u>			
1. Generator (G-1)	X		X
2. Transmission Circuit (L-1)	X		X
3. Transformer (T-1)	X		X
4. Shunt Device	X		X
5. Bus section	X		X
<u>P6 – Multiple Contingency – P1.2-P1.5 system adjustment and:</u>			
1. Transmission Circuit (L-1)	X	x	X
2. Transformer (T-1)	X	x	X
3. Shunt Device	X		X
4. Bus section	X		X
<u>P7 – Multiple Contingency - Fault plus stuck breaker</u>			
1. Two circuits on common structure (L-2)	X	X	X
2. Bipolar DC line	X	X	X
<u>Extreme event – loss of two or more elements</u>			
Two generators (Common Mode) G-2	X ⁴	X	X ⁴
Any P1.1-P1.3 & P1.5 system readjusted (Common Mode) L-2	X ⁴	X ³	X ⁵
All other extreme combinations.	X ⁴		X ⁴
¹ System must be able to readjust to a safe operating zone in order to be able to support the loss of the next contingency. ² A thermal or voltage criterion violation resulting from a transformer outage may not be cause for a local area reliability requirement if the violation is considered marginal (e.g. acceptable loss of facility life or low voltage), otherwise, such a violation will necessitate creation of a requirement. ³ Evaluate for risks and consequence, per NERC standards. No voltage collapse or dynamic instability allowed. ⁴ Evaluate for risks and consequence, per NERC standards. ⁵ Expanded to include any P1 system readjustment followed by any P7 without stuck breaker. For voltage collapse or dynamic instability situations mitigation is required “if there is a risk of cascading” beyond a relatively small predetermined area – less than 250 MW - directly affected by the outage.			

Table 2.1-2: Criteria Comparison for non-Bulk Electric System contingencies

Contingency Component(s)	Mandatory Reliability Standards	Old Local Capacity Criteria	New Local Capacity Criteria
<u>P0 – No Contingencies</u>	X	X	X

<u>P1 – Single Contingency</u>			
1. Generator (G-1)	X	X ¹	X
2. Transmission Circuit (L-1)	X	X ¹	X
3. Transformer (T-1)	X	X ^{1,2}	X
4. Shunt Device	X		X
5. Single Pole (dc) Line	X	X ¹	X
<u>P2 – Single contingency</u>			
1. Opening a line section w/o a fault			
2. Bus Section fault			
3. Internal Breaker fault (non-Bus-tie Breaker)			
4. Internal Breaker fault (Bus-tie Breaker)			
<u>P3 – Multiple Contingency – G-1 + system adjustment and:</u>			
1. Generator (G-1)	X	X	X
2. Transmission Circuit (L-1)	X	X	X
3. Transformer (T-1)	X	X ²	X
4. Shunt Device	X		X
5. Single Pole (dc) Line	X	X	X
<u>P4 – Multiple Contingency - Fault plus stuck breaker</u>			
1. Generator (G-1)			
2. Transmission Circuit (L-1)			
3. Transformer (T-1)			
4. Shunt Device			
5. Bus section			
6. Bus-tie breaker			
<u>P5 – Multiple Contingency – Relay failure (delayed clearing)</u>			
1. Generator (G-1)			
2. Transmission Circuit (L-1)			
3. Transformer (T-1)			
4. Shunt Device			
5. Bus section			
<u>P6 – Multiple Contingency – P1.2-P1.5 system adjustment and:</u>			
1. Transmission Circuit (L-1)		x	
2. Transformer (T-1)		x	
3. Shunt Device			
4. Bus section			
<u>P7 – Multiple Contingency - Fault plus stuck breaker</u>			
1. Two circuits on common structure (L-2)		X	
2. Bipolar DC line		X	
<u>Extreme event – loss of two or more elements</u>			
Two generators (Common Mode) G-2		X	
Any P1.1-P1.3 & P1.5 system readjusted (Common Mode) L-2		X ³	

All other extreme combinations.			
¹ System must be able to readjust to a safe operating zone in order to be able to support the loss of the next contingency. ² A thermal or voltage criterion violation resulting from a transformer outage may not be cause for a local area reliability requirement if the violation is considered marginal (e.g. acceptable loss of facility life or low voltage), otherwise, such a violation will necessitate creation of a requirement. ³ Evaluate for risks and consequence, per NERC standards. No voltage collapse or dynamic instability allowed.			

A significant number of simulations were run to determine the most critical contingencies within each local area. Using power flow, post-transient load flow, and stability assessment tools, the system performance results of all tested contingencies were measured against the system performance requirements defined by the criteria shown in Tables 1 and 2. Where the specific system performance requirements were not met, generation was adjusted until performance requirements were met for the local area. The adjusted generation constitutes the minimum generation needed in the local area. The following describes how the criteria were tested for the specific type of analysis performed.

2.1.1 Power Flow Assessment:

Table 2.1-3 Power flow criteria

Contingencies	Thermal Criteria ¹	Voltage Criteria ²
P0	Applicable Rating	Applicable Rating
P1 ³	Applicable Rating	Applicable Rating
P2	Applicable Rating	Applicable Rating
P3	Applicable Rating	Applicable Rating
P4	Applicable Rating	Applicable Rating
P5	Applicable Rating	Applicable Rating
P6 ⁴	Applicable Rating	Applicable Rating
P7	Applicable Rating	Applicable Rating
P1 + P7 ⁴	-	No Voltage Collapse

¹ Applicable Rating – Based on CAISO Transmission Register or facility upgrade plans including established Path ratings.

- ² Applicable Rating – CAISO Grid Planning Criteria or facility owner criteria as appropriate.
- ³ Following the first contingency (N-1), the generation must be sufficient to allow the operators to bring the system back to within acceptable operating range (voltage and loading) and/or appropriate OTC following the studied outage conditions and be able to safely prepare for the loss of the next most stringent element and be within Applicable Rating after the loss of the second element.
- ⁴ During normal operation or following the first contingency (N-1), the generation must be sufficient to allow the operators to prepare for the next worst N-1 or common mode N-2 without pre-contingency interruptible or firm load shedding. SPS/RAS/Safety Nets may be utilized to satisfy the criteria after the second N-1 or common mode N-2 except if the problem is of a thermal nature such that short-term ratings could be utilized to provide the operators time to shed either interruptible or firm load.

2.1.2 Post Transient Load Flow Assessment:

Table 2.1-4 Post transient load flow criteria

Contingencies	Reactive Margin Criteria ²
Selected ¹	Applicable Rating

- ¹ If power flow results indicate significant low voltages for a given power flow contingency, simulate that outage using the post transient load flow program. The post-transient assessment will develop appropriate Q/V and/or P/V curves.
- ² Applicable Rating – positive margin based on the higher of imports or load increase by 5% for N-1 contingencies, and 2.5% for N-2 contingencies.

2.1.3 Stability Assessment:

Table 2.1-5 Stability criteria

Contingencies	Stability Criteria ²
Selected ¹	Applicable Rating

- ¹ Base on historical information, engineering judgment and/or if power flow or post transient study results indicate significant low voltages or marginal reactive margin for a given contingency.
- ² Applicable Rating – CAISO Grid Planning Criteria or facility owner criteria as appropriate.

2.2 Load Forecast

2.2.1 System Forecast

The California Energy Commission (CEC) derives the load forecast at the system and Participating Transmission Owner (PTO) levels. This relevant CEC forecast is then distributed across the entire system, down to the local area, division and substation level. The PTOs use an econometric equation to forecast the system load. The predominant parameters affecting the system load are (1) number of households, (2) economic activity (gross metropolitan products, GMP), (3) temperature and (4) increased energy efficiency and distributed generation programs.

2.2.2 Base Case Load Development Method

The method used to develop the load in the base case is a melding process that extracts, adjusts and modifies the information from the system, distribution and municipal utility forecasts. The melding process consists of two parts: Part 1 deals with the PTO load and Part 2 deals with the municipal utility load. There may be small differences between the methodologies used by each PTO to disaggregate the CEC load forecast to their level of local area as well as bar-bus model.

2.2.2.1 PTO Loads in Base Case

The methods used to determine the PTO loads are, for the most part, similar. One part of the method deals with the determination of the division³ loads that would meet the requirements of 1-in-5 or 1-in-10 system or area base cases and the other part deals with the allocation of the division load to the transmission buses.

a. Determination of division loads

The annual division load is determined by summing the previous year division load and the current division load growth. Thus, the key steps are the determination of the initial year division load and the annual load growth. The initial year for the base case development method is based heavily on recorded data. The division load growth in the system base case is determined in two steps. First, the total PTO load growth for the year is determined, as the product of the PTO load and the load growth rate from the system load forecast. Then this total PTO load growth is allocated to the division, based on the relative magnitude of the load growth projected for the divisions by the distribution planners. For example, for the 1-in-10 area base case, the division load growth determined for the system base case is adjusted to the 1-in-10 temperature using the load temperature relation determined from the latest peak load and temperature data of the division.

b. Allocation of division load to transmission bus level

Since the loads in the base case are modeled at the various transmission buses, the division loads developed must be allocated to those buses. The allocation process is different depending

³ Each PTO divides its territory in a number of smaller area named divisions. These are usually smaller and compact areas that have the same temperature profile.

on the load types. For the most part, each PTO classifies its loads into four types: conforming, non-conforming, self-generation and generation-plant loads. Since the non-conforming and self-generation loads are assumed to not vary with temperature, their magnitude would be the same in the system or area base cases of the same year. The remaining load (the total division load developed above, less the quantity of non-conforming and self-generation load) is the conforming load. The remaining load is allocated to the transmission buses based on the relative magnitude of the distribution forecast. The summation of all base case loads is generally higher than the load forecast because some load, i.e., self-generation and generation-plant, are behind the meter and must be modeled in the base cases. However, for the most part, metered or aggregated data with telemetry is used to come up with the load forecast.

2.2.2.2 Municipal Loads in Base Case

The municipal utility forecasts that have been provided to the CEC and PTOs for the purposes of their base cases were also used for this study.

2.3 Power Flow Program Used in the LCR analysis

The technical studies were conducted using General Electric's Power System Load Flow (GE PSLF) program version 21.0_07 and PowerGem's Transmission Adequacy and Reliability Assessment (TARA) program version 1902. This GE PSLF program is available directly from GE or through the Western System Electricity Council (WECC) to any member and TARA program is commercially available.

To evaluate Local Capacity Areas, the starting base case was adjusted to reflect the latest generation and transmission projects as well as the one-in-ten-year peak load forecast for each Local Capacity Area as provided to the CAISO by the PTOs.

Electronic contingency files provided by the PTOs were utilized to perform the numerous contingencies required to identify the LCR. These contingency files include remedial action and special protection schemes that are expected to be in operation during the year of study. A CAISO created EPCL (a GE programming language contained within the GE PSLF package) routine and/or TARA software were used to run the combination of contingencies; however, other routines are available from WECC with the GE PSFL package or can be developed by third parties to identify the most limiting combination of contingencies requiring the highest amount of generation within the local area to maintain power flows within applicable ratings.

2.4 Estimate of Battery Storage Needs due to Charging Constraints

Local areas and sub-areas have limited transmission capability and therefore rely on internal resources to be available in order to reliably serve internal load. Battery storage will help serve local load during the discharge cycle, however it will also increase local load during the charging cycle.

Due to recent procurement activities geared toward the acquisition of this type of technology, the CAISO is herein estimating the characteristics (MW, MWh, discharge duration) required from battery storage technology in order to seamlessly integrate in each local area and sub-area.

The CAISO expects that for batteries that displace other local resource adequacy resources, the transmission capability under the most limiting contingency and the other local capacity resources must be sufficient to recharge the batteries in anticipation of the outage continuing through the night and into the next day's peak load period.

For each local area and sub-area, the CAISO has estimated the battery storage characteristics, given their unique load shape, constraints and requirements as well as the energy characteristics of other resources required to meet standards. Due to this fact, the strict addition of the sub-area battery storage characteristics (MW, MWh and duration) may not closely align with the overall local area battery storage characteristic requirements (MW, MWh and duration).

Assumptions

- 1) Total load serving capability includes capability from transmission system and local generation needed for LCR under the worst contingency.
- 2) Storage added replaces existing generation MW for MW. First the batteries will replace as much as possible of existing gas resources, Second if the area and/or sub-area has run out of gas resources to displace then other technologies may be reduced in order to determine the maximum battery charging limit.
- 3) Effectiveness factors are assumed not to be a factor. Battery storage is assumed to be installed at the same sites where resources are displaced or assumed to have the same effectiveness factors.
- 4) Deliverability of incremental storage capacity is not evaluated. It is assumed battery storage will take over deliverability from old resources through re-power. Any new battery storage resource needs to go through the generation interconnection process in order to receive deliverability and it is not evaluated in this study. CAISO cannot guaranty that there is enough deliverability available for new resources. New transmission upgrades may be required in order to make such new resources deliverable to the aggregate of load.
- 5) Includes battery storage charging/discharging efficiency of 85%.
- 6) Daily charging required is distributed to all non-discharging hours proportionally using delta between net load and the total load serving capability.
- 7) Energy required for charging, beyond the transmission capability under contingency condition, is produced by other LCR required resources within the local area and sub-area that are available for production during off-peak hours.
- 8) Hydro resources are considered to be available for production during off-peak hours, however these resources are energy limited themselves and based on past availability data they can have severely limited output during off-peak hours especially during late summer peaks under either normal or dry hydro years.

- 9) The study assumes the ability to provide perfect dispatch and the ability to enforce charging requirements for multiple contingency conditions (like N-1-1) in the day ahead time frame while the system is under normal (no contingency) conditions. CAISO software improvements and/or augmentations are required in order to achieve this goal.

Installing battery storage with insufficient characteristics (MW, MWh and duration) will not result in a one for one reduction of the local area or sub-area need for other types of resources. The CAISO expects that the overall RA portfolio provided by all LSEs to account for the uplift, beyond the minimum LCR need, in MWs required from other type of resources for all areas and sub-areas where LSEs have procured battery storage beyond the charging capability or with incorrect characteristics (MW, MWh and duration). If uplift is not provided the CAISO may use its back stop authority to assure that reliability standards are met throughout the day, including off-peak hours.

3 Locational Capacity Requirement Study Results

3.5 Summary of Study Results

LCR is defined as the amount of resource capacity that is needed within a Local Capacity Area to reliably serve the load located within this area. The results of the CAISO's analysis are summarized in the Executive Summary Tables.

Table 3.4-1 2030 Local Capacity Needs vs. Peak Load and Local Area Resources

	2030 Total LCR (MW)	Peak Load (1 in10) (MW)	2030 LCR as % of Peak Load	Total NQC Local Area Resources (MW)	2030 LCR as % of Total NQC
Humboldt	135	167	81%	191	71%
North Coast/North Bay	842	1472	57%	842	100%
Sierra	1518	1957	78%	2108	72%
Stockton	619	964	64%	619	100%
Greater Bay	7344	11195	66%	7344	100%
Greater Fresno	2296	3589	64%	3392	68%
Kern	413	1110	37%	413	100%
Big Creek/Ventura	1151	4478	26%	3894	30%
LA Basin	6194	19244	32%	7395	84%
San Diego/Imperial Valley	3718	4857	77%	4818	77%
Total*	24230	49033	49%	31016	78%

Table 3.4-2 2025 Local Capacity Needs vs. Peak Load and Local Area Resources

	2025 Total LCR (MW)	Peak Load (1 in10) (MW)	2025 LCR as % of Peak Load	Total NQC Local Area Resources (MW)	2025 LCR as % of Total NQC
Humboldt	132	153	86%	191	69%
North Coast/North Bay	837	1481	57%	842	99%
Sierra	1367	1918	71%	2108	65%
Stockton	619	950	65%	619	100%
Greater Bay	6110	10743	57%	7344	83%
Greater Fresno	1971	3279	60%	3392	58%
Kern	186	1651	11%	413	45%
Big Creek/Ventura	1002	4429	23%	3637	28%
LA Basin	6309	18826	34%	7423	85%
San Diego/Imperial Valley	3557	4675	76%	4818	74%
Total*	22090	48105	46%	30787	72%

* Value shown only illustrative, since each local area peaks at a different time.

Table 3.4-1 and Table 3.4-2 shows how much of the Local Capacity Area load is dependent on local resources and how many local resources must be available in order to serve the load in those Local Capacity Areas in a manner consistent with the Reliability Criteria. These tables also indicate where new transmission projects, new resource additions or demand side management programs would be most useful in order to reduce the dependency on existing, generally older and less efficient local area resources.

The term “Qualifying Capacity” used in this report is the “Net Qualifying Capacity” (“NQC”) posted on the CAISO web site at:

<http://www.caiso.com/planning/Pages/ReliabilityRequirements/Default.aspx>

The NQC list includes the area (if applicable) where each resource is located for units already operational. Neither the NQC list nor this report incorporates Demand Side Management programs and their related NQC. Units scheduled to become operational before June 1 of 2030 have been included in this 2030 Long-Term LCR Report and added to the total NQC values for those respective areas (see detail write-up for each area).

Regarding the main tables up front (page 2), the first column, “August Qualifying Capacity,” reflects three sets of resources. The first set is comprised of resources that would normally be expected to be on-line such as Municipal and Regulatory Must-take resources (state, federal, municipal and QFs). The second set is “market” based resources (market, net seller, wind and battery). The third set are solar resources, since they may or may not be available during the actual peak hour for the respective local area. The second column, “Capacity at Peak” identifies how much of the August Qualifying Capacity is expected to be available during the peak time for each particular local area. The third column, “YEAR LCR Need”, sets forth the local capacity

requirements, without the deficiencies that must be addressed, necessary to attain a service reliability level required to comply with NERC/WECC/CAISO mandatory reliability standards.

Table 3.1-3 includes estimated characteristics (MW, MWh, discharge duration) required from battery storage technology in order to seamlessly integrate in each local area and sub-area. The CAISO expects that for batteries that displace other local resource adequacy resources, the transmission capability under the most limiting contingency and the other local capacity resources must be sufficient to recharge the batteries in anticipation of the outage continuing through the night and into the next day's peak load period.

Table 3.1-3 2030 Battery Storage Characteristics Limited by Charging Capability

Area/Sub-area	Pmax MW	Energy MWh	Max. # of discharge hours	Max. MW of 4 hour battery (1 for 1 MW replacement)	Replacing mostly	Comment
Humboldt	43	131	5	32	gas	
North Coast/North Bay Overall	285	1913	11	55	geothermal	
Eagle Rock	29	200	9	15	geothermal	
Fulton	-	-	-	-	-	Need eliminated
Sierra	-	-	-	-	-	Flow through
Placer	71	586	9	27	hydro	
Pease	-	-	-	-	-	Need eliminated
South of Rio Osos	-	-	-	-	-	Flow through
Stockton	-	-	-	-	-	Sum of sub-areas
Lockeford	-	-	-	-	-	Need eliminated
Tesla-Bellota	400	2800	8	120	gas	
Greater Bay Overall	2630	15804	10	1500	gas	
Llagas	32	168	7	13	gas	
San Jose	448	3248	11	200	gas	
South Bay-Moss Landing	477	2722	12	375	gas	
Oakland	36	271	13		distillate	
Greater Fresno Overall	2290	2207	6	600	hydro	
Panoche	35	240	13	22	gas	
Herndon	475	1832	9	280	hydro	
Borden	-	-	-	-	-	Need eliminated
Hanford	65	231	6	65	-	
Coalinga	75	275	7	75	-	
Reedley	71	429	9	33	-	
Kern Overall	-	-	-	-	-	N/A
Westpark	45	227	8	41	gas	
Kern 70 kV	-	-	-	-	-	Need eliminated

Area/Sub-area	Pmax MW	Energy MWh	Max. # of discharge hours	Max. MW of 4 hour battery (1 for 1 MW replacement)	Replacing mostly	Comment
Kern Tevis	45	200	7	35	none	
Kern Oil	115	624	10	76	gas	
South Kern PP	430	2600	12	275	gas	
Big Creek/Ventura Overall	363	2752	13	128	gas	
Vestal	115	1003	12	15	hydro	
Santa Clara	148	1159	11	18	gas	
LA Basin Overall	3550	27244	11	1070	gas	
Eastern	1610	12142	11	475	gas	
Western	1510	12348	11	420	gas	
El Nido	231	1587	11	91	gas	
San Diego/Imperial Valley Overall	1187	6994	10	680	gas	
San Diego	1187	6973	10	680	gas	
Border	31	185	8	16	gas	

3.6 Summary of Results by Local Area

Each Local Capacity Area's overall requirement is determined by also achieving each sub-area requirement. Because these areas are a part of the interconnected electric system, the total for each Local Capacity Area is not simply a summation of the sub-area needs. For example, some sub-areas may overlap and therefore the same units may count for meeting the needs in both sub-areas.

3.6.1 Humboldt Area

3.6.1.1 *Area Definition:*

The transmission tie lines into the area include:

Bridgeville-Cottonwood 115 kV line #1

Humboldt-Trinity 115 kV line #1

Laytonville-Garberville 60 kV line #1

Trinity-Maple Creek 60 kV line #1

The substations that delineate the Humboldt Area are:

Bridgeville is in, Low Gap, Wildwood and Cottonwood are out

Humboldt is in, Trinity is out

Kekawaka and Garberville are in, Laytonville is out

Maple Creek is in, Trinity and Ridge Cabin are out

3.6.1.1.1 Humboldt LCR Area Diagram

Figure 3.6-1 Humboldt LCR Area

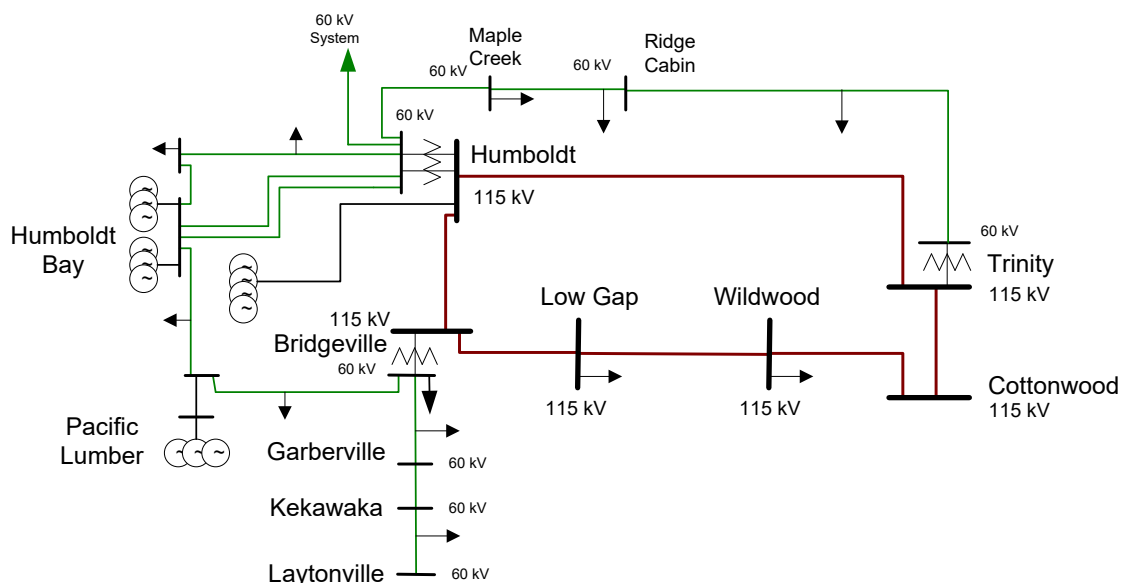

3.6.1.1.2 Humboldt LCR Area Load and Resources

Table 3.6-1 provides the forecasted load and resources. The list of generators within the LCR area are provided in Attachment A.

In year 2030 the estimated time of local area peak is 19:00 PM.

This area does not contain models of solar resources capable of providing resource adequacy.

If required, all non-solar technology type resources are dispatched at NQC.

Table 3.6-1 Humboldt LCR Area 2030 Forecast Load and Resources

Load (MW)		Generation (MW)	Aug NQC	At Peak
Gross Load	160	Market	191	191
AAEE	-2	MUNI	0	0
Behind the meter DG	0	QF	0	0
Net Load	158	LTPP Preferred Resources	0	0
Transmission Losses	9	Existing 20-minute Demand Response	0	0
Pumps	0	Mothballed	0	0
Load + Losses + Pumps	167	Total	191	191

3.6.1.1.3 Humboldt LCR Area Hourly Profiles

Figure 3.6-2 illustrates the forecast 2030 profile for the peak day for the Humboldt LCR area along with the Category P6 normal and emergency load serving capabilities without local capacity

resources. The chart also includes an estimated amount of energy storage that can be added to this local area from charging restriction perspective and the amount of 4-hour storage that can be added to replace local capacity on a 1 MW for 1 MW basis. Figure 3.6-3 illustrates the forecast 2030 hourly profile for Humboldt LCR area with the Category P6 transmission capability without local capacity resources.

Figure 3.6-2 Humboldt 2030 Peak Day Forecast Profiles

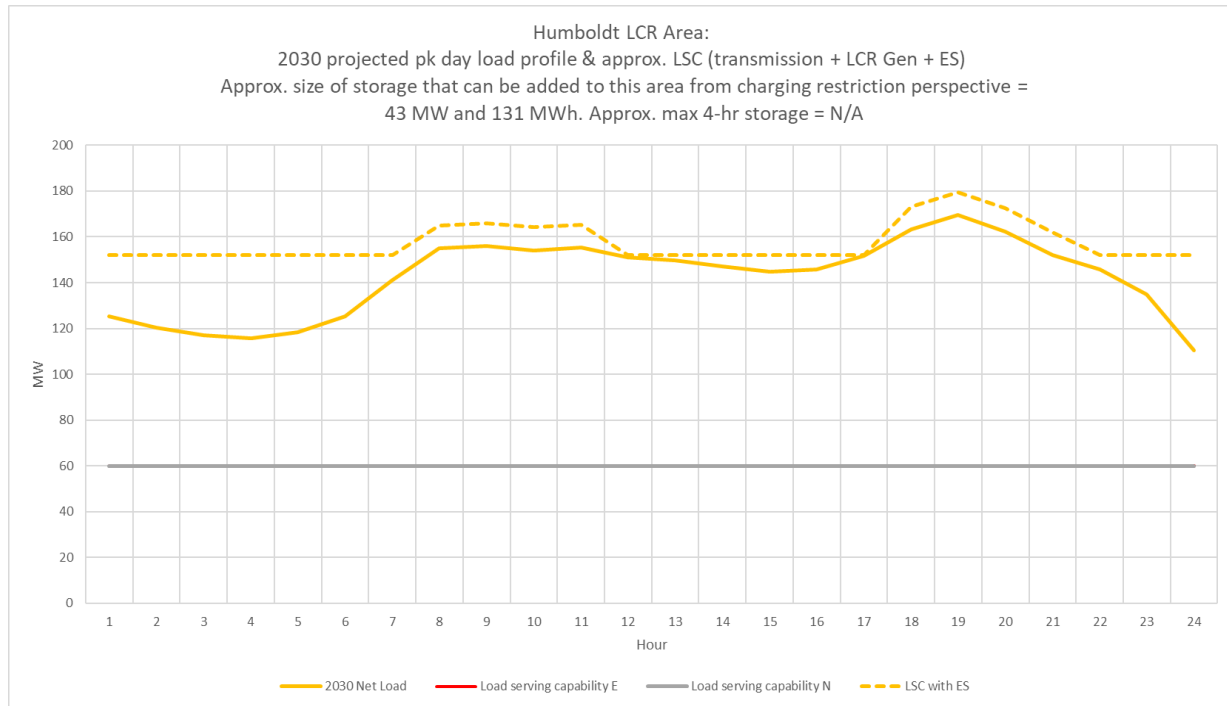
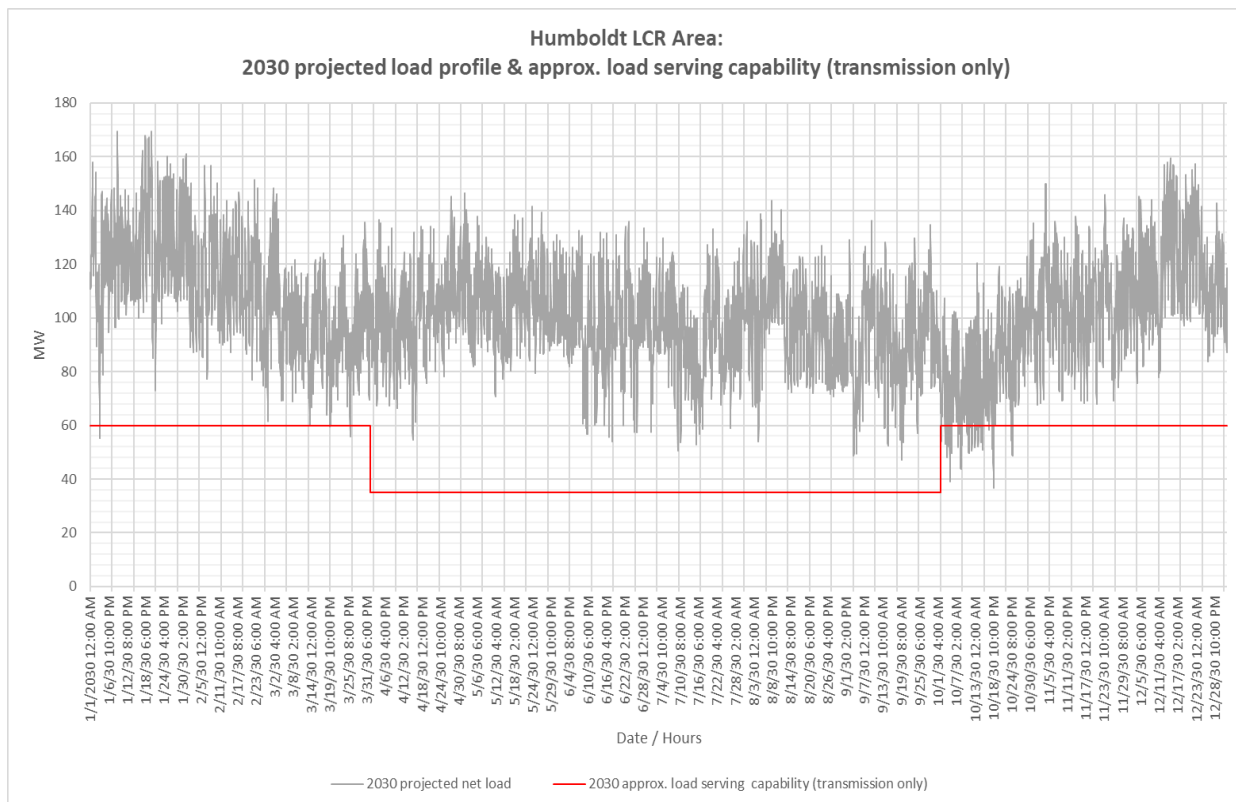

Figure 3.6-3 Humboldt 2030 Forecast Hourly Profile



3.6.1.1.4 Approved transmission projects included in base cases

Maple Creek Reactive Support

Garberville Reactive Support

Bridgeville 115/60 kV #1 transformer replacement

3.6.1.2 Humboldt Overall LCR Requirement

Table 3.6-2 identifies the area LCR requirements. The LCR requirement for Category P6 contingency is 135 MW.

Table 3.6-2 Humboldt LCR Area Requirements

Year	Limit	Category	Limiting Facility	Contingency	LCR (MW) (Deficiency)
2030	First Limit	P6	Humboldt-Trinity 115 kV	Cottonwood-Bridgeville 115 kV & Humboldt - Humboldt Bay 115 kV	135

3.6.1.2.1 Effectiveness factors:

For most helpful procurement information please read procedure 2210Z Effectiveness Factors under 7110 stated at: <http://www.aiso.com/Documents/2210Z.pdf>

3.6.1.2.2 Changes compared to the 2025 LCT study:

Load forecast decreased by 14 MW and the total LCR has increased by 3 MW.

3.6.1.2.3 Alternatives to Reduce or Eliminate Gas Generation

In the 2020-2021 transmission planning process the Humboldt LCR Area was not selected to assess alternatives to reduce or eliminate the requirement for gas-fired generation to address the LCR requirement.

3.6.2 North Coast / North Bay Area**3.6.2.1 Area Definition:**

The transmission tie facilities coming into the North Coast/North Bay area are:

Cortina-Mendocino 115 kV Line

Cortina-Eagle Rock 115 kV Line

Willits-Garberville 60 kV line #1

- Vaca Dixon-Lakeville 230 kV line #1
- Tulucay-Vaca Dixon 230 kV line #1
- Lakeville-Sobrante 230 kV line #1
- Ignacio-Sobrante 230 kV line #1

The substations that delineate the North Coast/North Bay area are:

- Cortina is out, Mendocino and Indian Valley are in
- Cortina is out, Eagle Rock, Highlands and Homestake are in
- Willits and Lytonville are in, Kekawaka and Garberville are out
- Vaca Dixon is out, Lakeville is in
- Tulucay is in, Vaca Dixon is out
- Lakeville is in, Sobrante is out
- Ignacio is in, Sobrante and Crocket are out

3.6.2.1.1 North Coast and North Bay LCR Area Diagram

Figure 3.6-4 North Coast and North Bay LCR Area

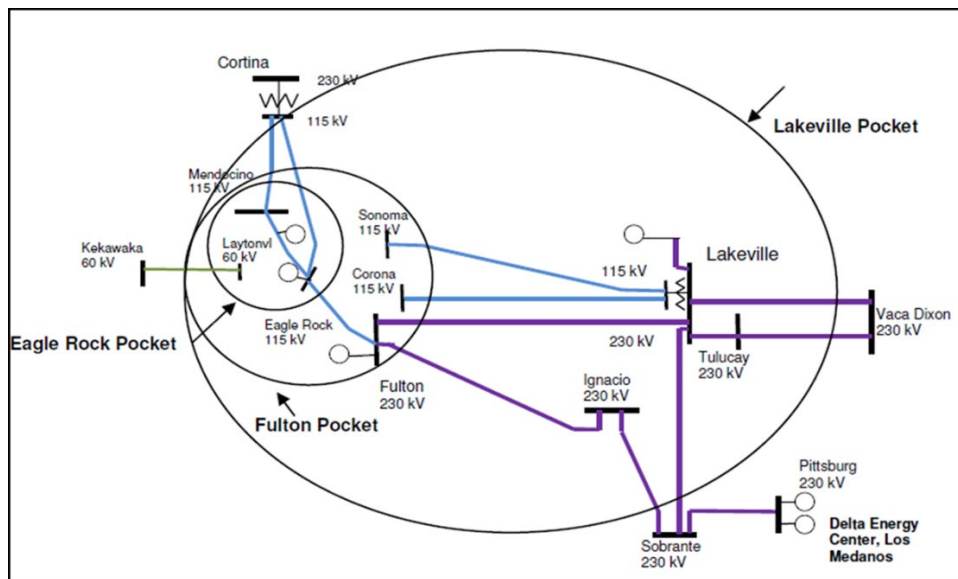

3.6.2.1.2 North Coast and North Bay LCR Area Load and Resources

Table 3.6-3 provides the forecasted load and resources. The list of generators within the LCR area are provided in Attachment A.

In year 2030 the estimated time of local area peak is 18:20 PM.

This area does not contain models of solar resources capable of providing resource adequacy.

If required, all non-solar technology type resources are dispatched at NQC.

Table 3.6-3 North Coast and North Bay LCR Area 2030 Forecast Load and Resources

Load (MW)		Generation (MW)	Aug NQC	At Peak
Gross Load	1492	Market, Net Seller	723	723
AAEE	-31	MUNI	114	114
Behind the meter DG	0	QF	5	5
Net Load	1461	Solar	0	0
Transmission Losses	11	Existing 20-minute Demand Response	0	0
Pumps	0	Mothballed	0	0
Load + Losses + Pumps	1472	Total	842	842

3.6.2.1.3 North Coast and North Bay LCR Area Hourly Profiles

Figure 3.6-5 illustrates the forecast 2030 profile for the peak day for the North Coast/North Bay LCR area along with the Category P3 normal and emergency load serving capabilities without local capacity resources. The chart also includes an estimated amount of energy storage that can be added to this local area from charging restriction perspective and the amount of 4-hour storage that can be added to replace local capacity on a 1 MW for 1 MW basis. Figure 3.6-6 illustrates the forecast 2030 hourly profile for North Coast North Bay LCR area with the Category P3 emergency load serving capability without local capacity resources.

Figure 3.6-5 North Coast and North Bay 2030 Peak Day Forecast Profiles

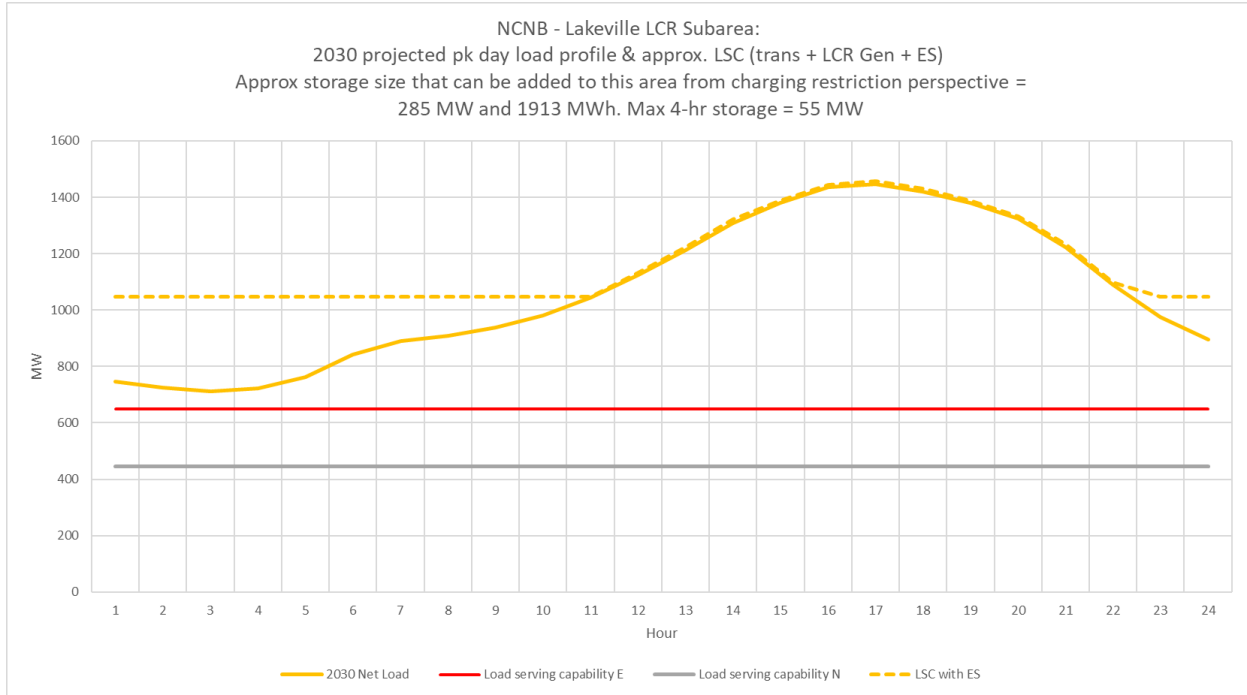
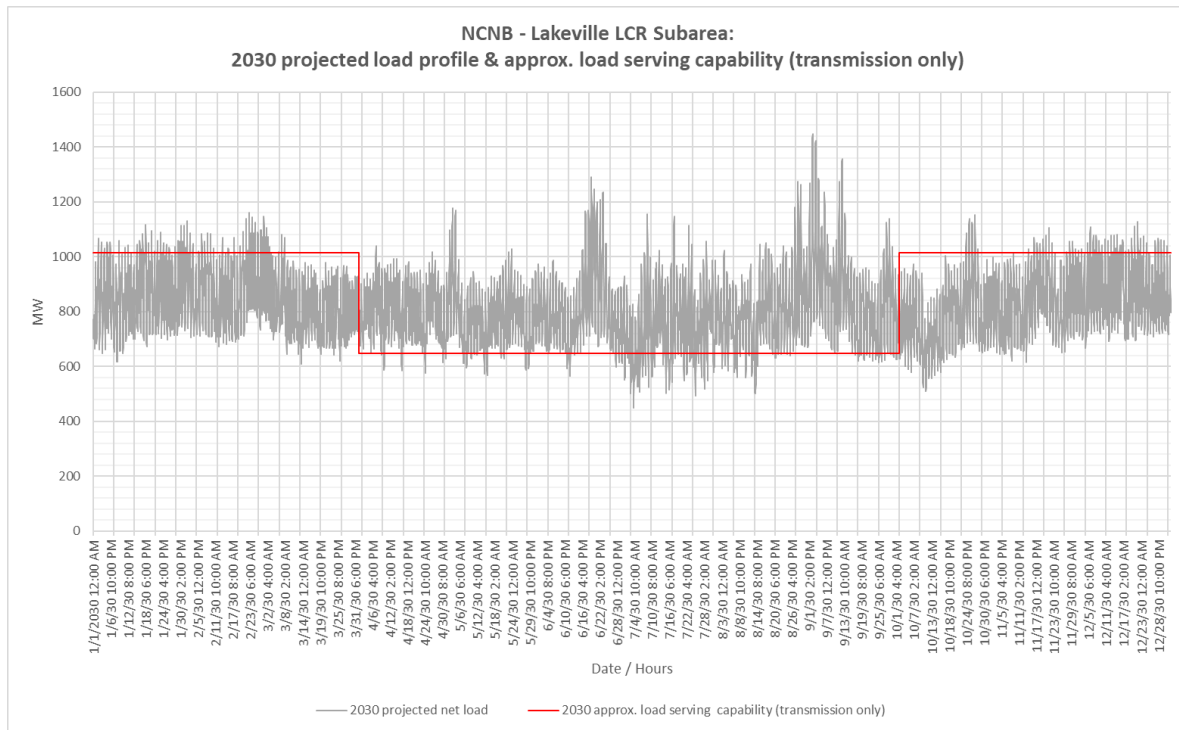

Figure 3.6-6 North Coast and North Bay 2030 Forecast Hourly Profile



3.6.2.1.4 Approved transmission projects modeled in base cases

Vaca Dixon-Lakeville 230 kV Corridor Series Compensation

Fulton-Fitch Mountain 60 kV Line Reconductor

Clear Lake 60 kV System Reinforcement

Ignacio-Alta 60 kV Line Conversion

Lakeville 60 kV Area Reinforcement

3.6.2.2 ***Eagle Rock LCR Sub-area***

Eagle Rock is a Sub-area of the North Coast and North Bay LCR Area.

3.6.2.2.1 **Eagle Rock LCR Sub-area Diagram**

Figure 3.6-7 Eagle Rock LCR Sub-area

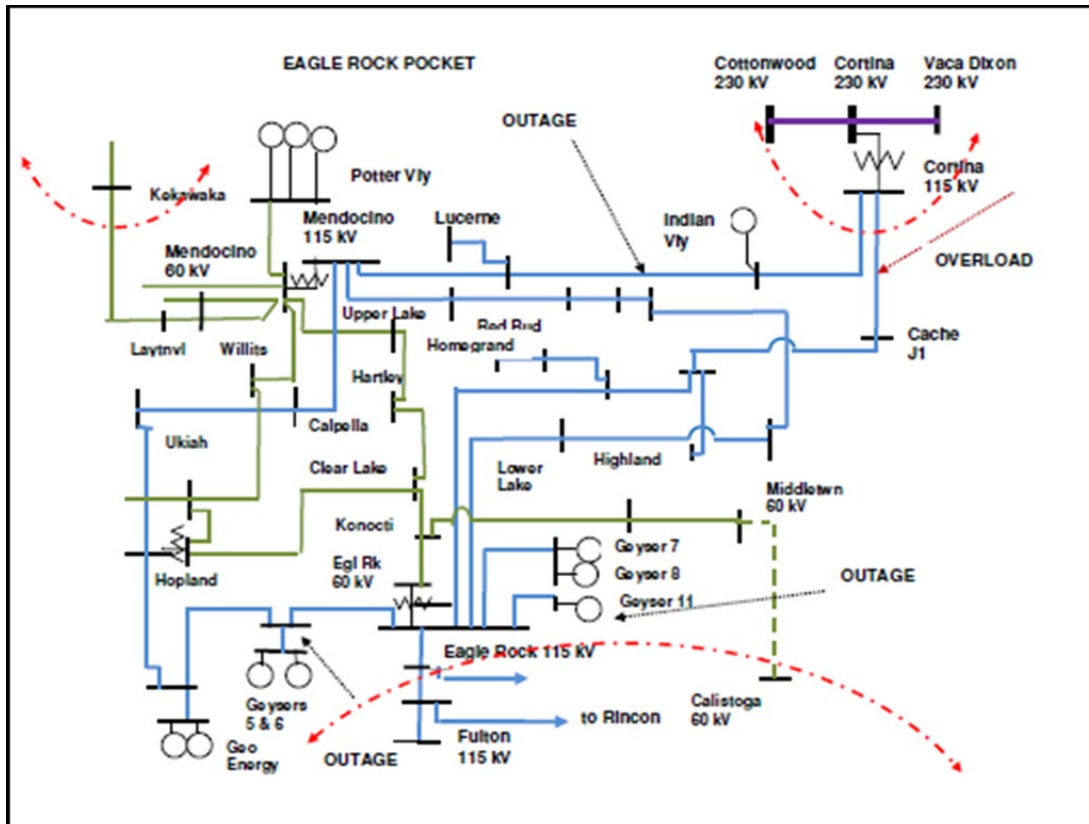

3.6.2.2.2 Eagle Rock LCR sub-area Load and Resources

Table 3.6-4 provides the forecasted load and resources. The list of generators within the LCR sub-area are provided in Attachment A.

Table 3.6-4 Eagle Rock LCR Area 2030 Forecast Load and Resources

Load (MW)		Generation (MW)		Aug NQC	At Peak
Gross Load	231	Market, Net Seller		248	248
AAEE	-6	MUNI		2	2
Behind the meter DG	0	QF		0	0
Net Load	225	Solar		0	0
Transmission Losses	15	Existing 20-minute Demand Response		0	0
Pumps	0	Mothballed		0	0
Load + Losses + Pumps	240	Total		250	250

3.6.2.2.3 Eagle Rock LCR Sub-area Hourly Profiles

Figure 3.6-8 illustrates the forecast 2030 profile for the peak day for the Eagle Rock LCR Sub-area with the Category P3 normal and emergency load serving capabilities without local capacity resources. The chart also includes an estimated amount of energy storage that can be added to this local area from charging restriction perspective and the amount of 4-hour storage that can be added to replace local capacity on a 1 MW for 1 MWh basis. Figure 3.6-9 illustrates the forecast 2030 hourly profile for Eagle Rock LCR sub-area with the Category P3 emergency load serving capability without local capacity resources.

Figure 3.6-8 Eagle Rock LCR Sub-area 2030 Peak Day Forecast Profiles

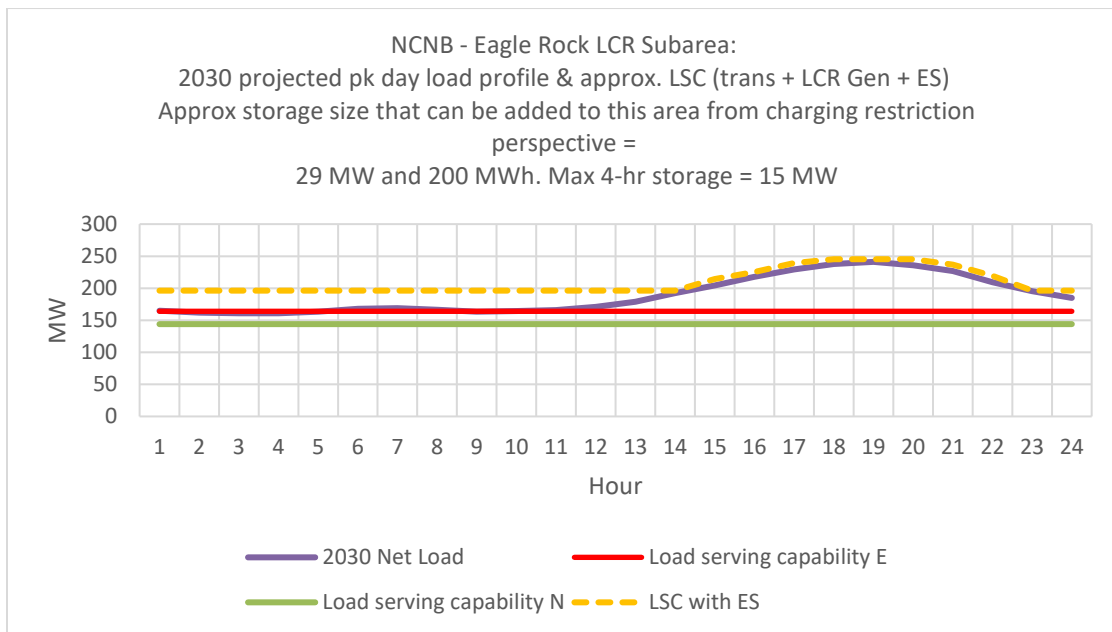
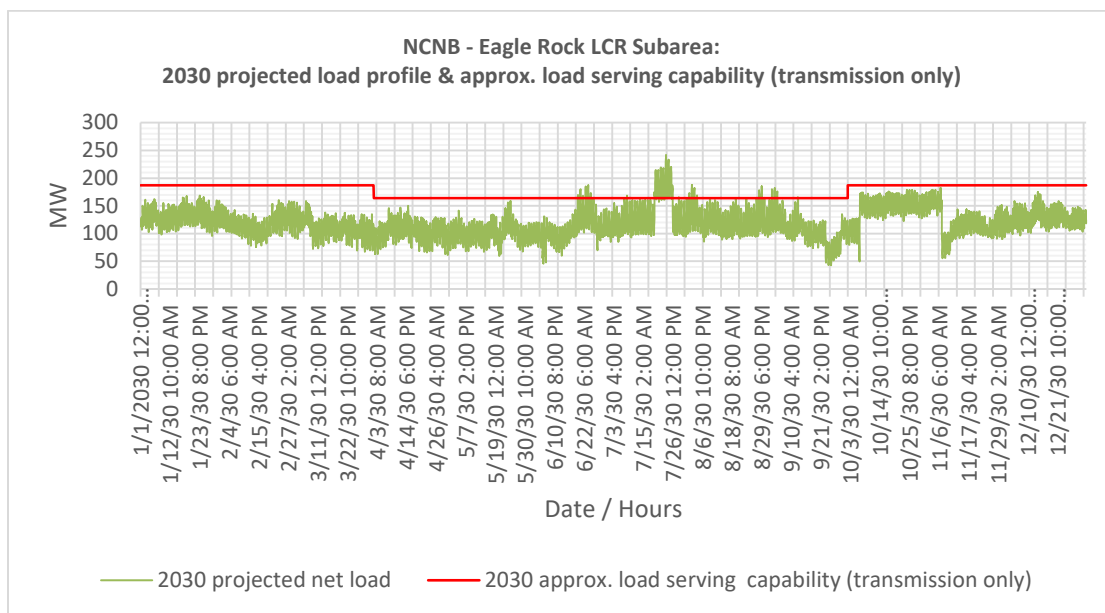

Figure 3.6-9 Eagle Rock LCR Sub-area 2030 Forecast Hourly Profiles



3.6.2.2.4 Eagle Rock LCR Sub-area Requirement

Table 3.6-5 identifies the sub-area LCR requirements. The LCR requirement for Category P6 contingency is 125 MW.

Table 3.6-5 Eagle Rock LCR Sub-area Requirements

Year	Limit	Category	Limiting Facility	Contingency	LCR (MW) (Deficiency)
2030	First Limit	P3	Eagle Rock-Cortina 115 kV line	Cortina-Mendocino 115 kV with Geysers #11 unit out	122
2030	First Limit	P6	Eagle Rock-Cortina 115 kV line	Cortina-Mendocino and Geysers #3-Geysers #5 115 kV lines out	125

3.6.2.2.5 Effectiveness factors:

Effectiveness factors for generators in the Eagle Rock LCR Sub-area are in Attachment B table titled [Eagle Rock](#).

For most helpful procurement information please read procedure 2210Z Effectiveness Factors under 7120 posted at: <http://www.aiso.com/Documents/2210Z.pdf>

3.6.2.2.6 Alternatives to Reduce or Eliminate Gas Generation

This sub-area has no gas generation therefor no studies are required.

3.6.2.3 Fulton Sub-area

Fulton is a Sub-area of the North Coast and North Bay LCR Area. The 2030 LCT study identified that the Fulton Sub-area will no longer be required due to Lakeville #2 60 kV line (Lakeville-Petaluma-Cotati 60 kV) being permanently open.

3.6.2.4 North Coast and North Bay Overall

3.6.2.4.1 North Coast and North Bay Overall Requirement

Table 3.6-6 identifies the sub-area LCR requirements. The LCR requirement for Category P3 contingency are 1068 MW including a 226 MW deficiency.

Table 3.6-6 North Coast and North Bay LCR area Requirements

Year	Limit	Category	Limiting Facility	Contingency	LCR (MW) (Deficiency)
2030	First Limit	P3	Vaca Dixon-Tulucay 230 kV	Vaca Dixon-Lakeville 230 kV with DEC power plant out of service	1068 (226)

3.6.2.4.2 Effectiveness factors:

Effectiveness factors for generators in the North Coast and North Bay LCR area are in Attachment B table titled [Lakeville](#).

3.6.2.4.3 Changes compared to the 2025 LCT study:

Overall the load forecast went down by 9 MW compared to 2025. The overall LCR requirement went up by 231 MW as a result of a change in limiting contingency and equipment.

3.6.2.4.4 Alternatives to Reduce or Eliminate Gas Generation

This sub-area has no gas generation therefore no studies are required.

3.6.3 Sierra Area**3.6.3.1 Area Definition:**

The transmission tie lines into the Sierra Area are:

Table Mountain-Rio Oso 230 kV line

Table Mountain-Palermo 230 kV line

Table Mt-Pease 60 kV line

Caribou-Palermo 115 kV line

Drum-Summit 115 kV line #1

Drum-Summit 115 kV line #2

Spaulding-Summit 60 kV line

Brighton-Bellota 230 kV line

Rio Oso-Lockeford 230 kV line

Gold Hill-Eight Mile Road 230 kV line

Lodi-Eight Mile Road 230 kV line

Gold Hill-Lake 230 kV line

The substations that delineate the Sierra Area are:

Table Mountain is out Rio Oso is in

Table Mountain is out Palermo is in

Table Mt is out Pease is in

Caribou is out Palermo is in

Drum is in Summit is out

Drum is in Summit is out

Spaulding is in Summit is out

Brighton is in Bellota is out

Rio Oso is in Lockeford is out

Gold Hill is in Eight Mile is out

Lodi is in Eight Mile is out

Gold Hill is in Lake is out

3.6.3.1.1 Sierra LCR Area Diagram

Figure 3.6-10 Sierra LCR Area

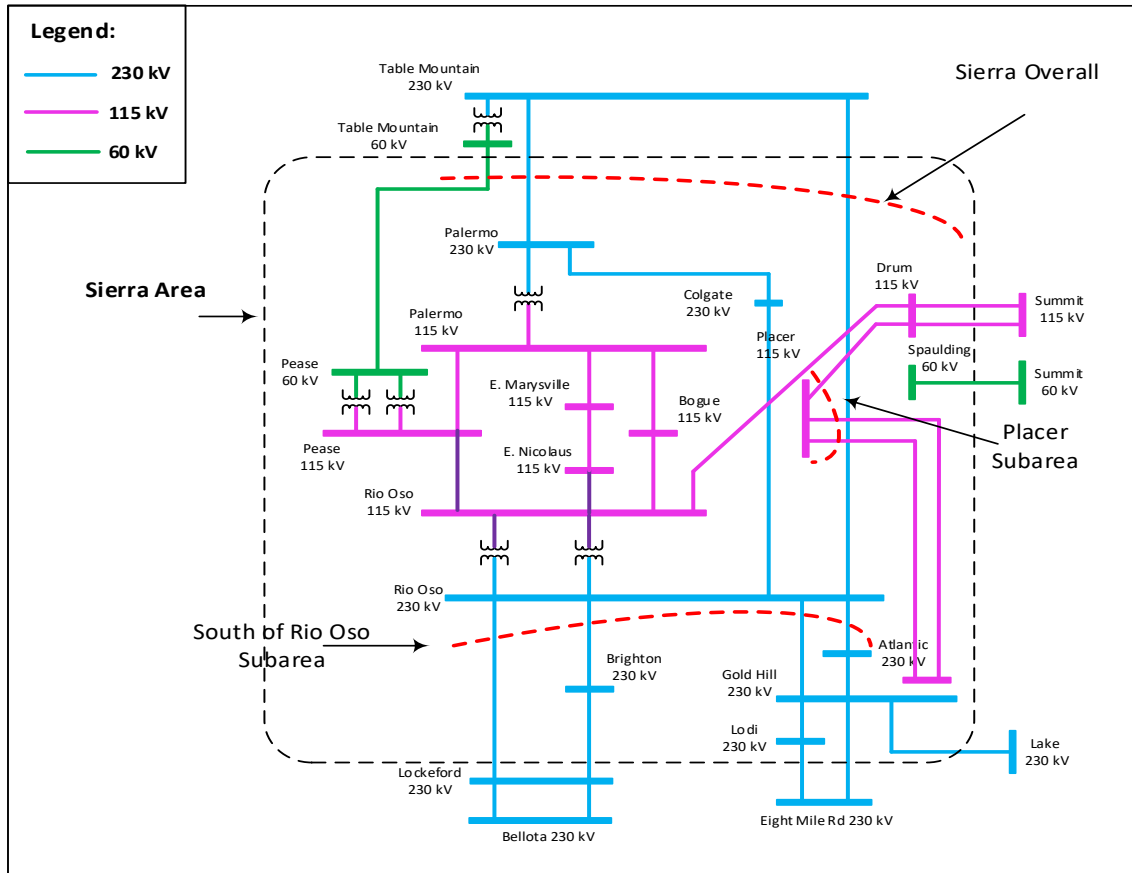

3.6.3.1.2 Sierra LCR Area Load and Resources

Table 3.6-7 provides the forecasted load and resources. The list of generators within the LCR area are provided in Attachment A.

In year 2030 the estimated time of local area peak is 19:30 PM.

At the local area peak time the estimated, ISO metered, solar output is 0.00%.

If required, all non-solar technology type resources are dispatched at NQC.

Table 3.6-7 Sierra LCR Area 2030 Forecast Load and Resources

Load (MW)		Generation (MW)	Aug NQC	At Peak
Gross Load	1911	Market, Net Seller	920	920
AEE	-42	MUNI	1142	1142
Behind the meter DG	0	QF	41	41
Net Load	1869	Solar	5	0

Transmission Losses	87	Existing 20-minute Demand Response	0	0
Pumps	0	Mothballed	0	0
Load + Losses + Pumps	1957	Total	2108	2103

3.6.3.1.3 Approved transmission projects modeled:

- Rio Oso #1 and #2 230/115 kV transformer replacement
- South of Palermo 115 kV Reinforcement
- Vaca-Davis Area Reinforcement
- Rio Oso Area 230 kV Voltage Support
- East Marysville 115/60 kV
- Gold Hill 230/115 kV Transformer Addition

3.6.3.2 Placer Sub-area

Placer is a sub-area of the Sierra LCR area.

3.6.3.2.1 Placer LCR Sub-area Diagram

Figure 3.6-11 Placer LCR Sub-area

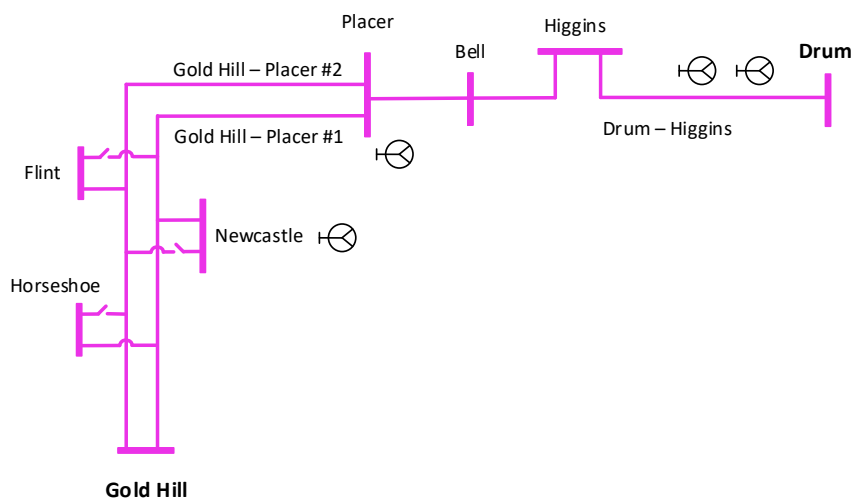

3.6.3.2.2 Placer LCR Sub-area Load and Resources

Table 3.6-8 provides the forecasted load and resources. The list of generators within the LCR sub-area are provided in Attachment A.

Table 3.6-8 Placer LCR Sub-area 2030 Forecast Load and Resources

Load (MW)	Generation (MW)	Aug NQC	At Peak

Gross Load	174	Market, Net Seller	54	54
AAEE	-4	MUNI	42	42
Behind the meter DG	0	QF	0	0
Net Load	170	Solar	0	0
Transmission Losses	12	Existing 20-minute Demand Response	0	0
Pumps	0	Mothballed	0	0
Load + Losses + Pumps	182	Total	96	96

3.6.3.2.3 Placer LCR Sub-area Hourly Profiles

Figure 3.6-12 illustrates the forecast 2030 profile for the peak day for the Placer LCR sub-area with the Category P6 normal and emergency capabilities without local capacity resources. The chart also includes an estimated amount of energy storage that can be added to this local area from charging restriction perspective and the amount of 4-hour storage that can be added to replace local capacity on a 1 MW for 1 MWh basis. Figure 3.6-13 illustrates the forecast 2030 hourly profile for Placer LCR sub-area with the Category P6 emergency load serving capability without local capacity resources.

Figure 3.6-12 Placer LCR Sub-area 2030 Peak Day Forecast Profiles

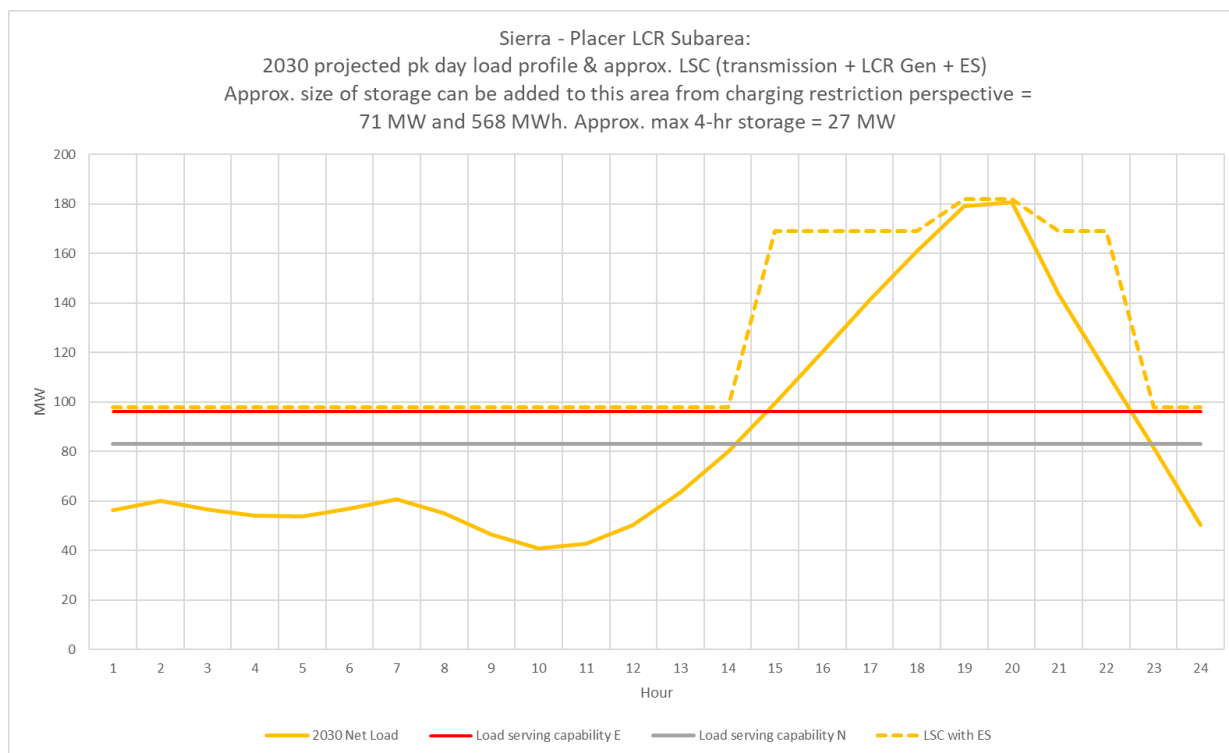
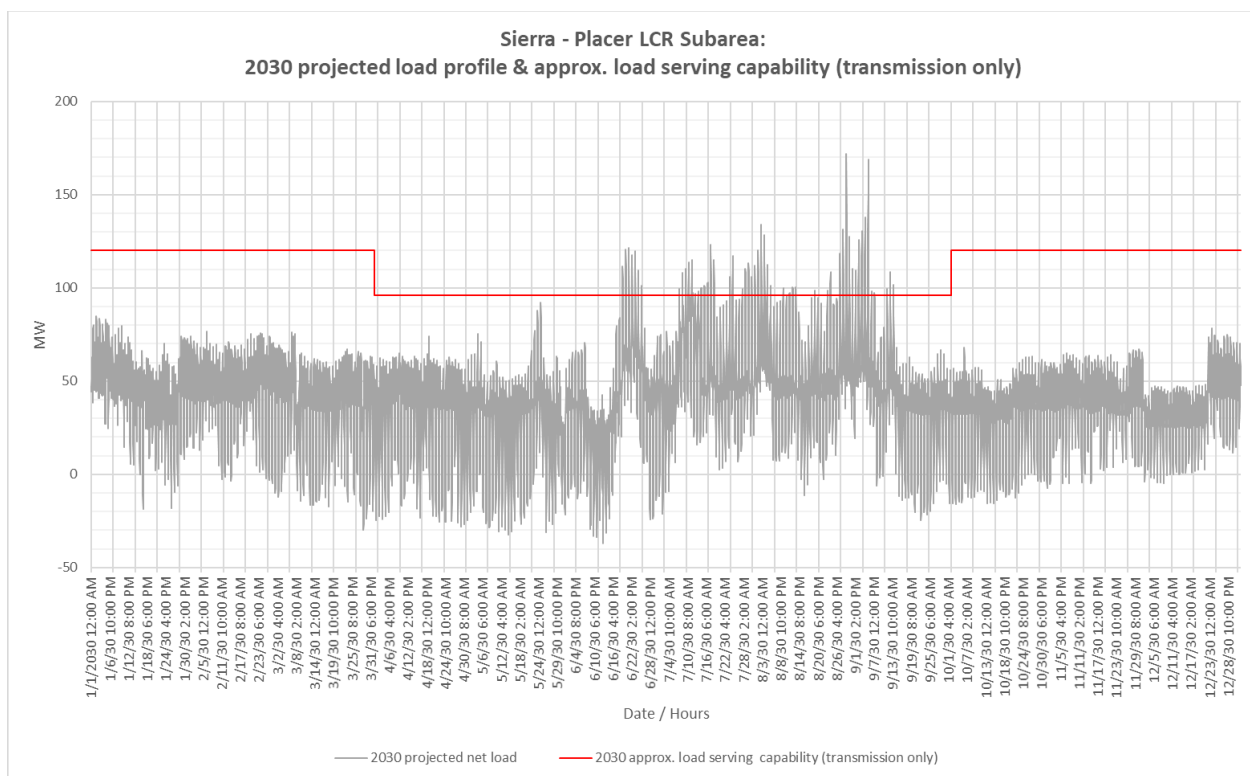

Figure 3.6-13 Placer LCR Sub-area 2030 Forecast Hourly Profiles



3.6.3.2.4 Placer LCR Sub-area Requirement

Table 3.6-9 identifies the sub-area LCR requirements. The LCR requirement for Category P6 contingency is 106 MW, including 10 MW of deficiency.

Table 3.6-9 Placer LCR Sub-area Requirements

Year	Limit	Category	Limiting Facility	Contingency	LCR (MW) (Deficiency)
2030	First Limit	P6, P7	Low voltage at Placer, Bell, and Higgins 115 kV busses	Gold Hill-Placer #1 115 kV & Gold Hill-Placer #2 115 kV	106 (10)

3.6.3.2.5 Effectiveness factors

All units within the Placer Sub-area have the same effectiveness factor.

For most helpful procurement information please read procedure 2210Z Effectiveness Factors under 7240 posted at: <http://www.caiso.com/Documents/2210Z.pdf>

3.6.3.3 Pease Sub-area

Pease is a sub-area of the Sierra LCR area.

Pease sub-area will be eliminated due to the East Marysville 115/60 kV transmission project

3.6.3.4 *Drum-Rio Oso Sub-area*

Drum-Rio Oso is a sub-area of the Sierra LCR area.

Drum-Rio Oso sub-area will be eliminated due to the Rio Oso 230/115 kV transformer upgrade transmission project.

3.6.3.5 *Gold Hill-Drum Sub-area*

Gold Hill-Drum is a sub-area of the Sierra LCR area.

Gold Hill-Drum sub-area will be eliminated due to the Gold Hill 230/115 kV Transformer Addition transmission project.

3.6.3.6 *South of Rio Oso Sub-area*

South of Rio Oso is a sub-area of the Sierra LCR area.

3.6.3.6.1 *South of Rio Oso LCR Sub-area Diagram*

Figure 3.6-14 Pease LCR Sub-area

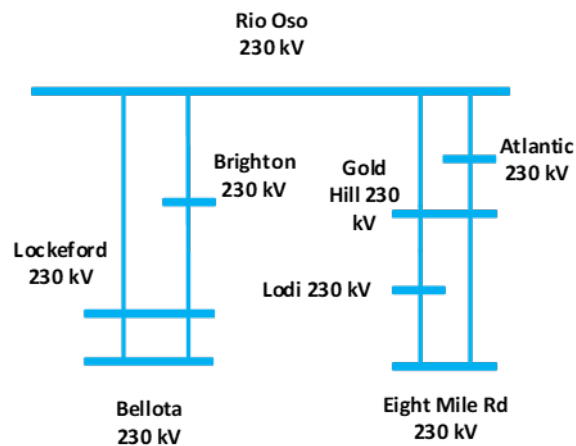

3.6.3.6.2 *South of Rio Oso LCR Sub-area Load and Resources*

The South of Rio Oso sub-area does not have a defined load pocket with the limits based upon power flow through the area. Table 3.6-10 provides the forecasted resources in the sub-area. The list of generators within the LCR area are provided in Attachment A.

Table 3.6-10 South of Rio Oso LCR Sub-area 2030 Forecast Load and Resources

Load (MW)	Generation (MW)	Aug NQC	At Peak
The South of Rio Oso Sub-area does not have a defined load pocket with the limits based upon power flow through the area.	Market	122	122
	MUNI	621	621
	QF	0	0
	LTPP Preferred Resources	0	0
	Existing 20-minute Demand Response	0	0
	Mothballed	0	0
	Total	743	743

3.6.3.6.3 South of Rio Oso LCR Sub-area Hourly Profiles

The South of Rio Oso Sub-area does not have a defined load pocket with the limits based upon power flow through the area. As such, no load profile is provided for this sub-area.

3.6.3.6.4 South of Rio Oso LCR Sub-area Requirement

Table 3.6-11 identifies the sub-area LCR requirements. The LCR requirements for Category P6 contingency is 227 MW.

Table 3.6-11 South of Rio Oso LCR Sub-area Requirements

Year	Limit	Category	Limiting Facility	Contingency	LCR (MW) (Deficiency)
2030	First limit	P6	Rio Oso – Atlantic 230 kV	Rio Oso – Gold Hill 230 kV Rio Oso – Brighton 230 kV	227

3.6.3.6.5 Effectiveness factors:

Effectiveness factors for generators in the South of Rio Oso LCR Sub-area are in Attachment B table titled [Rio Oso](#).

For other helpful procurement information please read procedure 2210Z Effectiveness Factors under 7230 posted at: <http://www.caiso.com/Documents/2210Z.pdf>

3.6.3.6.6 Alternatives to Reduce or Eliminate Gas Generation

The 2028 LCT study identified for the South of Rio Oso Sub-area that the LCR requirement can be met by the non-gas generation in the area. Therefore no alternatives were required to be assessed in the 2020-2021 transmission planning process.

3.6.3.7 *South of Palermo Sub-area*

South of Palermo is a sub-area of the Sierra LCR area.

South of Palermo sub-area will be eliminated due to the South of Palermo transmission project.

3.6.3.8 *Sierra Area Overall*

3.6.3.8.1 *Sierra LCR Area Hourly Profiles*

The Sierra LCR Area limits are based upon power flow through the area. As such, no load profile is provided for the area.

3.6.3.8.2 *Sierra LCR Area Requirement*

Table 3.6-12 identifies the area requirements. The LCR requirement for Category P6 contingency is 1518 MW.

Table 3.6-12 Sierra Area Requirements

Year	Limit	Category	Limiting Facility	Contingency	LCR (MW) (Deficiency)
2030	First limit	P6	Table Mountain – Pease 60 kV	Table Mountain – Palermo 230 kV Table Mountain – Rio Oso 230 kV	1518

3.6.3.8.3 *Effectiveness factors:*

Effectiveness factors for generators in the Sierra overall area are in Attachment B table titled [Sierra Overall](#).

For other helpful procurement information please read procedure 2210Z Effectiveness Factors under 7230 and 7240 posted at: <http://www.caiso.com/Documents/2210Z.pdf>

3.6.3.8.4 *Changes compared to the 2025 LCT study:*

The load forecast went up by 39 MW. The total LCR need has increased by 119 MW and the total existing capacity required has increased by 151 MW mostly due to increase in load forecast.

3.6.3.8.5 *Alternatives to Reduce or Eliminate Gas Generation*

The 2028 LCT study identified for the Sierra overall area that the LCR requirement can be met by the non-gas generation in the area. With this no alternatives were required to be assessed in the 2020-2021 transmission planning process.

3.6.4 *Stockton Area*

The LCR requirement for the Stockton Area is driven by the sum of the requirements for the Tesla-Bellota and Weber sub-areas.

3.6.4.1 **Area Definition:**

Tesla-Bellota Sub-Area Definition

The transmission facilities that establish the boundary of the Tesla-Bellota sub-area are:

- Bellota 230/115 kV Transformer #1
- Bellota 230/115 kV Transformer #2
- Tesla-Tracy 115 kV Line
- Tesla-Salado 115 kV Line
- Tesla-Salado-Manteca 115 kV line
- Tesla-Schulte #1 115 kV Line
- Tesla-Schulte #2 115kV line
- Tesla-Vierra 115 kV Line

The substations that delineate the Tesla-Bellota Sub-area are:

- Bellota 230 kV is out Bellota 115 kV is in
- Bellota 230 kV is out Bellota 115 kV is in
- Tesla is out Tracy is in
- Tesla is out Salado is in
- Tesla is out Salado and Manteca are in
- Tesla is out Schulte is in
- Tesla is out Schulte is in
- Tesla is out Thermal Energy is in

Weber Sub-Area Definition

The transmission facilities that establish the boundary of the Weber Sub-area are:

- Weber 230/60 kV Transformer #1
- Weber 230/60 kV Transformer #2

The substations that delineate the Weber Sub-area are:

- Weber 230 kV is out Weber 60 kV is in
- Weber 230 kV is out Weber 60 kV is in

3.6.4.1.1 Stockton LCR Area Diagram

The Stockton LCR Area is comprised of the individual noncontiguous Sub-areas with diagrams provided for each of the Sub-areas below.

3.6.4.1.2 Stockton LCR Area Load and Resources

Table 3.6-13 provides the forecast load and resources in the area. The list of generators within the LCR area are provided in Attachment A.

In year 2030 the estimated time of local area peak is 19:30 PM.

At the local area peak time the estimated, ISO metered, solar output is 0.00%.

If required, all non-solar technology type resources are dispatched at NQC.

Table 3.6-13 Stockton LCR Area 2030 Forecast Load and Resources

Load (MW)		Generation (MW)	NQC	At Peak
Gross Load	964	Market, Net Seller	491	491
AAEE	-20	MUNI	116	116
Behind the meter DG	0	QF	0	0
Net Load	944	Solar	12	0
Transmission Losses	20	Existing 20-minute Demand Response	0	0
Pumps	0	Mothballed	0	0
Load + Losses + Pumps	964	Total	619	607

3.6.4.1.3 Stockton LCR Area Hourly Profiles

The Stockton LCR Area is comprised of the individual noncontiguous sub-areas with profiles provided for each of the sub-areas below.

3.6.4.1.4 Approved transmission projects modeled

Vierra 115 kV Looping Project

Lockeford-Lodi Area 230 kV Development

3.6.4.2 Weber Sub-area

Weber sub-area has been eliminated due to change in LCR criteria.

3.6.4.3 Lockeford Sub-area

Lockeford sub-area will be eliminated due to the Lockeford-Lodi Area 230 kV Development transmission project.

3.6.4.4 Stanislaus Sub-area

Stanislaus is a sub-area of the Stockton LCR area.

3.6.4.4.1 Stanislaus LCR Sub-area Diagram

Figure 3.6-15 Stanislaus LCR Sub-area

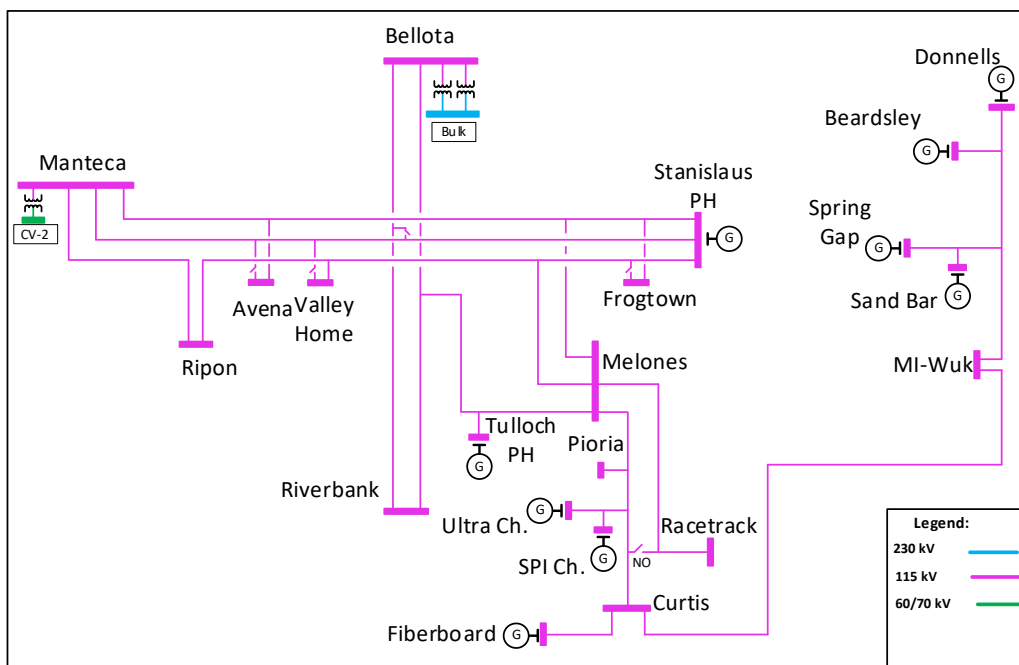

3.6.4.4.2 Stanislaus LCR Sub-area Load and Resources

The Stanislaus sub-area does not have a defined load pocket with the limits based upon power flow through the area. Table 3.6-14 provides the forecasted resources in the sub-area. The list of generators within the LCR sub-area are provided in Attachment A.

Table 3.6-14 Stanislaus LCR Sub-area 2030 Forecast Load and Resources

Load (MW)	Generation (MW)	Aug NQC	At Peak
The Stanislaus Sub-area does not have a defined load pocket with the limits based upon power flow through the area.	Market, Net Seller	117	117
	MUNI	94	94
	QF	0	0
	Solar	0	0
	Existing 20-minute Demand Response	0	0
	Mothballed	0	0
	Total	211	211

3.6.4.4.3 Stanislaus LCR Sub-area Hourly Profiles

The Stanislaus sub-area does not have a defined load pocket with the limits based upon power flow through the area. As such, no load profile is provided for this sub-area.

3.6.4.4.4 Stanislaus LCR Sub-area Requirement

Table 3.6-15 identifies the sub-area requirements. The LCR requirement for Category P3 contingency is 212 MW including 1 MW deficiency.

Table 3.6-15 Stanislaus LCR Sub-area Requirements

Year	Limit	Category	Limiting Facility	Contingency	LCR (MW) (Deficiency)
2030	First limit	P3	Manteca – Ripon 115 kV	Bellota-Riverbank-Melones 115 kV and Stanislaus PH	212 (1)

3.6.4.4.5 Effectiveness factors:

All units within the Stanislaus Sub-area have the same effectiveness factor.

For most helpful procurement information please read procedure 2210Z Effectiveness Factors under 7410 posted at: <http://www.caiso.com/Documents/2210Z.pdf>

3.6.4.4.6 Alternatives to Reduce or Eliminate Gas Generation

The 2029 LCT study identified for the Stanislaus sub-area that the LCR requirement can be met by the non-gas generation in the area. Therefore no alternatives were required to be assessed in the 2020-2021 transmission planning process.

3.6.4.5 Tesla-Bellota Sub-area

Tesla-Bellota is a sub-area of the Stockton LCR area.

3.6.4.5.1 Tesla-Bellota LCR Sub-area Diagram

Figure 3.6-16 Tesla-Bellota LCR Sub-area

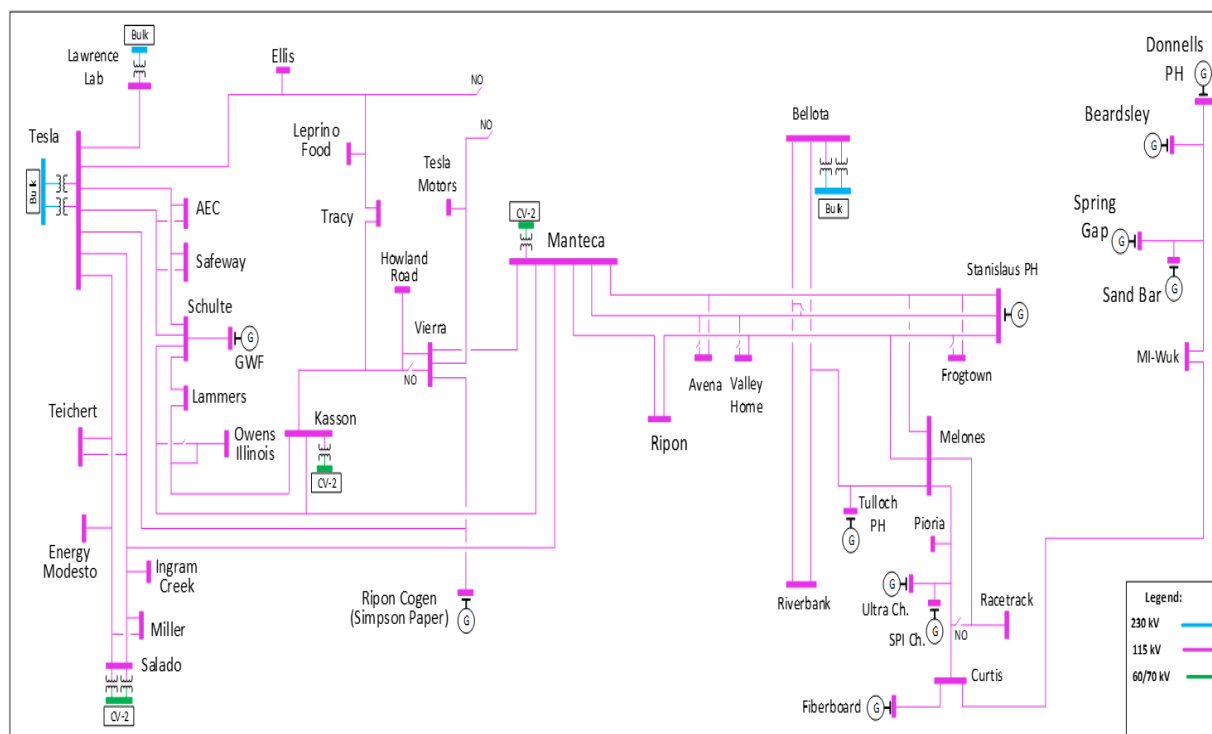

3.6.4.5.2 Tesla Bellota LCR Sub-area Load and Resources

Table 3.6-16 provides the forecasted load and resources. The list of generators within the LCR sub-area are provided in Attachment A.

Table 3.6-16 Tesla-Bellota LCR Sub-area 2030 Forecast Load and Resources

Load (MW)	Generation (MW)	Aug NQC	At Peak
Gross Load	964	Market, Net Seller	491
AAEE	-20	MUNI	116
Behind the meter DG	0	QF	0
Net Load	944	LTPP Preferred Resources	12
Transmission Losses	20	Existing 20-minute Demand Response	0
Pumps	0	Mothballed	0
Load + Losses + Pumps	964	Total	619

All of the resources needed to meet the Stanislaus sub-area count towards the Tesla-Bellota sub-area LCR need.

3.6.4.5.3 Tesla-Bellota LCR Sub-area Hourly Profiles

Figure 3.6-17 illustrates the forecast 2030 profile for the peak day for the Tesla-Bellota sub-area with the Category P6 normal and emergency load serving capabilities without local capacity resources. The chart also includes an estimated amount of energy storage that can be added to this local area from charging restriction perspective and the amount of 4-hour storage that can be added to replace local capacity on a 1 MW for 1 MWh basis. Figure 3.6-18 illustrates the forecast 2030 hourly profile for Tesla-Bellota sub-area with of the Category P6 emergency load serving capability without local capacity resources.

Figure 3.6-17 Tesla-Bellota LCR Sub-area 2030 Peak Day Forecast Profiles

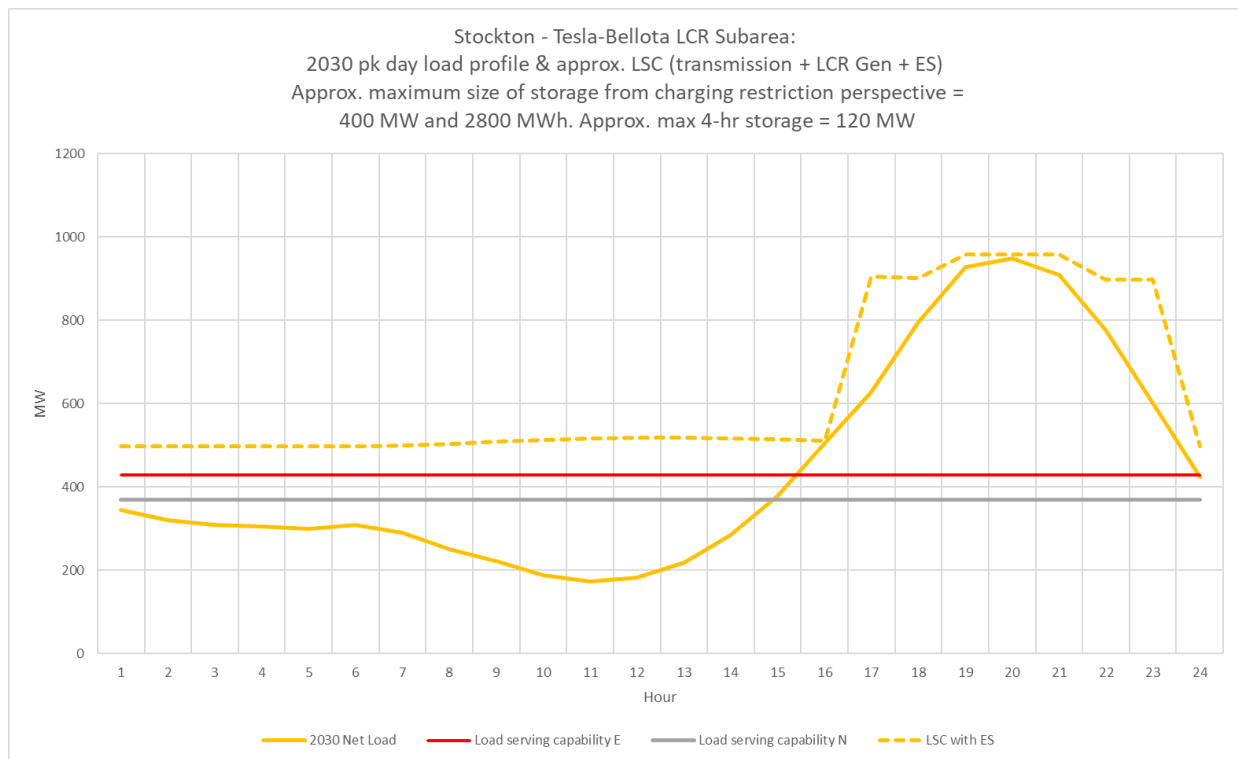
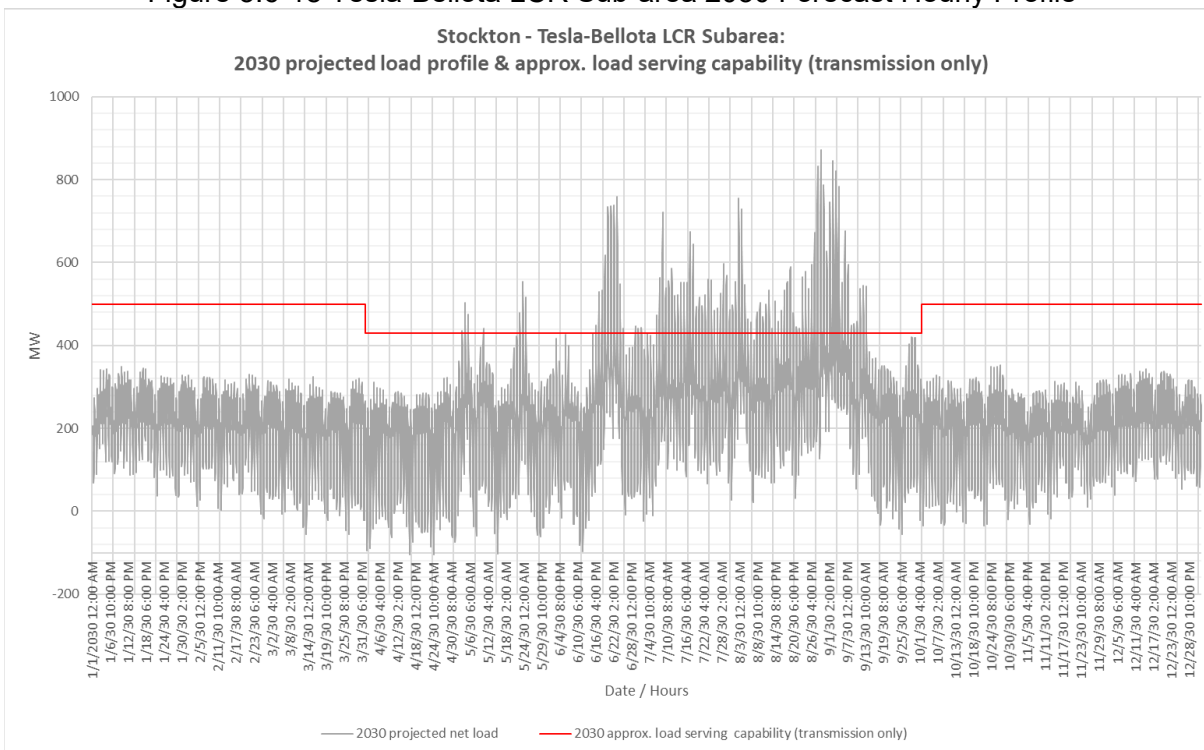

Figure 3.6-18 Tesla-Bellota LCR Sub-area 2030 Forecast Hourly Profile



3.6.4.5.4 Tesla-Bellota LCR Sub-area (Stockton Overall) Requirement

Table 3.6-17 identifies the sub-area LCR requirements. The LCR requirement for Category P2 and P6 contingency is 918 MW including a 299 MW of NQC deficiency or 311 MW of at peak deficiency.

Table 3.6-17 Tesla-Bellota LCR Sub-area Requirements

Year	Limit	Category	Limiting Facility	Contingency	LCR (MW) (Deficiency)
2030	First limit	P2-4	Stanislaus – Melones – Riverbank Jct 115 kV	Tesla 115 kV Bus	748 (129 NQC/ 141 Peak)
2030	First limit	P6	Tesla – Vierra 115 kV	Schulte – Lammers 115 kV & Schulte-Kasson-Manteca 115 kV	608 (299 NQC/ 311 Peak)
Total LCR Need for Tesla – Bellota Sub-area in 2030					918 (299 NQC/ 311 Peak)

3.6.4.5.5 Effectiveness factors:

All units within the Tesla-Bellota Sub-area have the same effectiveness factor.

For most helpful procurement information please read procedure 2210Z Effectiveness Factors under 7410 posted at: <http://www.aiso.com/Documents/2210Z.pdf>

3.6.4.5.6 Alternatives to Reduce or Eliminate Gas Generation

In the 2020-2021 transmission planning process the Tesla-Bellota LCR Sub-area was not selected to assess alternatives to reduce or eliminate the requirement for gas-fired generation to address the LCR requirement. As a part of the 2019-2020 transmission planning process the ISO undertook an assessment of the Tesla-Bellota sub-area in order to determine potential transmission alternatives to reduce or eliminate the need for gas-fired generation.

3.6.4.6 Stockton Overall

3.6.4.6.1 Stockton LCR Area Overall Requirement

The requirement for this area is driven by the requirement for the Tesla-Bellota sub-area. Table 3.6-18 identifies the area requirements. The LCR requirement for Category P6 contingency is 918 MW with a 299 MW NQC deficiency or 311 MW at peak deficiency.

Table 3.6-18 Stockton LCR Sub-area Overall Requirements

Year	Limit	Category	Limiting Facility	Contingency	LCR (MW) (Deficiency)
2030		P6	Stockton Overall		918 (299 NQC/ 311 Peak)

3.6.4.6.2 Changes compared to the 2025 LCT study

The load forecast went up by 14 MW and the total LCR need has increased by 177 MW mostly due to load growth.

3.6.4.6.3 Alternatives to Reduce or Eliminate Gas Generation

Stockton overall is just a mathematical addition of sub-area requirements, alternatives for all the sub-areas were assessed above.

3.6.5 Greater Bay Area

3.6.5.1 Area Definition:

The transmission tie lines into the Greater Bay Area are:

Lakeville-Sobrante 230 kV

Ignacio-Sobrante 230 kV

Parkway-Moraga 230 kV

Bahia-Moraga 230 kV

Lambie SW Sta-Vaca Dixon 230 kV

Peabody-Contra Costa P.P. 230 kV
Tesla-Kelso 230 kV
Tesla-Delta Switching Yard 230 kV
Tesla-Pittsburg #1 230 kV
Tesla-Pittsburg #2 230 kV
Tesla-Newark #1 230 kV
Tesla-Newark #2 230 kV
Tesla-Ravenswood 230 kV
Tesla-Metcalf 500 kV
Moss Landing-Metcalf 500 kV
Moss Landing-Metcalf #1 230 kV
Moss Landing-Metcalf #2 230 kV
Oakdale TID-Newark #1 115 kV
Oakdale TID-Newark #2 115 kV

The substations that delineate the Greater Bay Area are:

Lakeville is out Sobrante is in
Ignacio is out Sobrante is in
Parkway is out Moraga is in
Bahia is out Moraga is in
Lambie SW Sta is in Vaca Dixon is out
Peabody is out Contra Costa P.P. is in
Tesla is out Kelso is in
Tesla is out Delta Switching Yard is in
Tesla is out Pittsburg is in
Tesla is out Pittsburg is in
Tesla is out Newark is in
Tesla is out Newark is in
Tesla is out Ravenswood is in
Tesla is out Metcalf is in
Moss Landing is out Metcalf is in
Moss Landing is out Metcalf is in

Moss Landing is out Metcalf is in

Oakdale TID is out Newark is in

Oakdale TID is out Newark is in

3.6.5.1.1 Greater Bay LCR Area Diagram

Figure 3.6-19 Greater Bay LCR Area

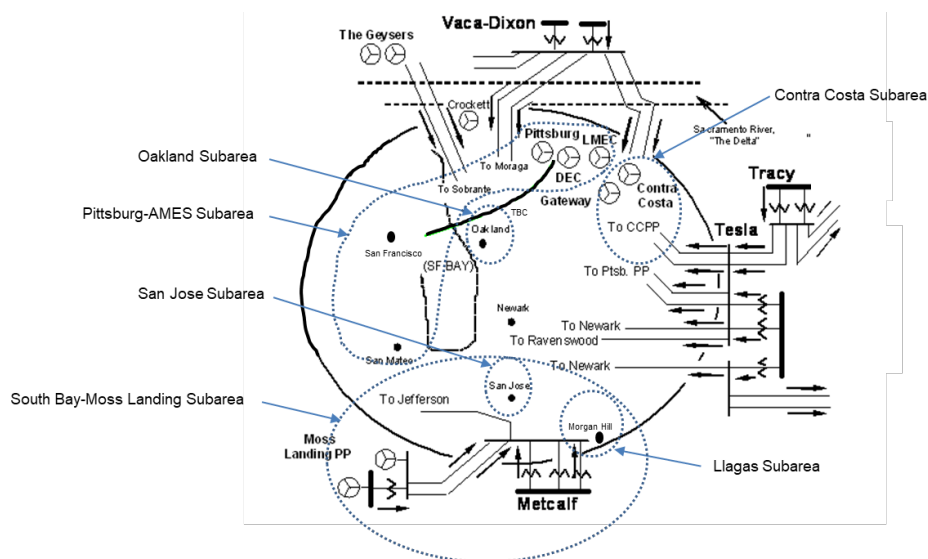

3.6.5.1.2 Greater Bay LCR Area Load and Resources

Table 3.6-19 provides the forecasted load and resources. The list of generators within the LCR area are provided in Attachment A.

In year 2030 the estimated time of local area peak is 17:50 PM.

At the local area peak time the estimated, ISO metered, solar output is 44.00%.

If required, all technology type resources, including solar, are dispatched at NQC.

Table 3.6-19 Greater Bay Area LCR Area 2030 Forecast Load and Resources

Load (MW)		Generation (MW)	Aug NQC	At Peak
Gross Load	10889	Market, Net Seller, Battery, Wind	6138	6138
AAEE	-217	MUNI	377	377
Behind the meter DG	0	QF	227	227
Net Load	10672	Solar	8	8
Transmission Losses	259	Existing 20-minute Demand Response	0	0
Pumps	264	Future preferred resource and energy storage	594	594

Load + Losses + Pumps	11195	Total	7344	7344
-----------------------	-------	-------	------	------

3.6.5.1.3 Approved transmission projects modeled

- Oakland Clean Energy Initiative Project (Oakland CTs are assumed retired)
- Morgan Hill Area Reinforcement (revised scope)
- Metcalf-Piercy & Swift and Newark-Dixon Landing 115 kV Upgrade
- East Shore-Oakland J 115 kV Reconductoring Project
- Vaca Dixon-Lakeville 230 kV Corridor Series Compensation
- Metcalf-Evergreen 115 kV Line Reconductoring
- Trimble-San Jose B 115 kV Line Limiting Facility Upgrade
- Trimble-San Jose B 115 kV Series Reactor
- Moss Landing-Panoche 230 kV Path Upgrade
- South of San Mateo Capacity Increase

3.6.5.2 Llagas Sub-area

Llagas is a sub-area of the Greater Bay LCR area.

3.6.5.2.1 Llagas LCR Sub-area Diagram

Figure 3.6-20 Llagas LCR Sub-area

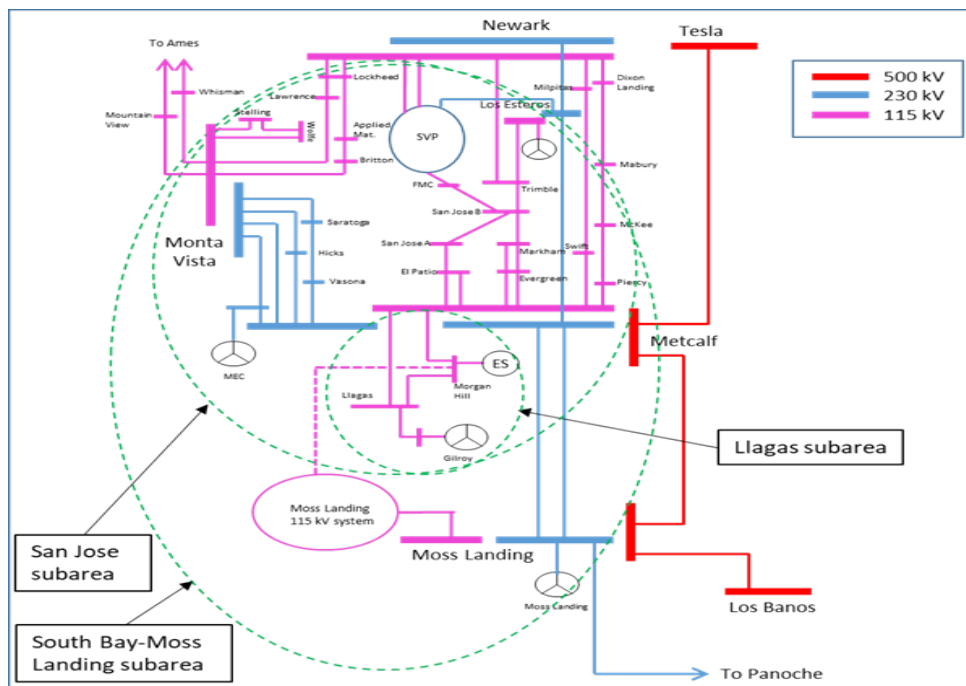

3.6.5.2.2 Llagas LCR Sub-area Load and Resources

Table 3.6-20 provides the forecasted load and resources. The list of generators within the LCR sub-area are provided in Attachment A.

Table 3.6-20 Llagas LCR Sub-area 2030 Forecast Load and Resources

Load (MW)		Generation (MW)	Aug NQC	At Peak
Gross Load	202	Market, Net Seller, Battery, Solar	246	246
AAEE	-4	MUNI	0	0
Behind the meter DG	0	QF	0	0
Net Load	198	LTPP Preferred Resources	0	0
Transmission Losses	0	Existing 20-minute Demand Response	0	0
Pumps	0	Mothballed	0	0
Load + Losses + Pumps	198	Total	246	246

3.6.5.2.3 Llagas LCR Sub-area Hourly Profiles

Figure 3.6-21 illustrates the forecast 2030 profile for the peak day for the Llagas LCR sub-area with the Category P6 normal and emergency load serving capabilities without local capacity resources. The chart also includes an estimated amount of energy storage that can be added to this local area from charging restriction perspective and the amount of 4-hour storage that can be added to replace local capacity on a 1 MW for 1 MW basis. Figure 3.6-22 illustrates the forecast 2030 hourly profile for Llagas LCR sub-area with the Category P6 emergency load serving capability without local capacity resources.

Figure 3.6-21 Llagas LCR Sub-area 2030 Peak Day Forecast Profiles

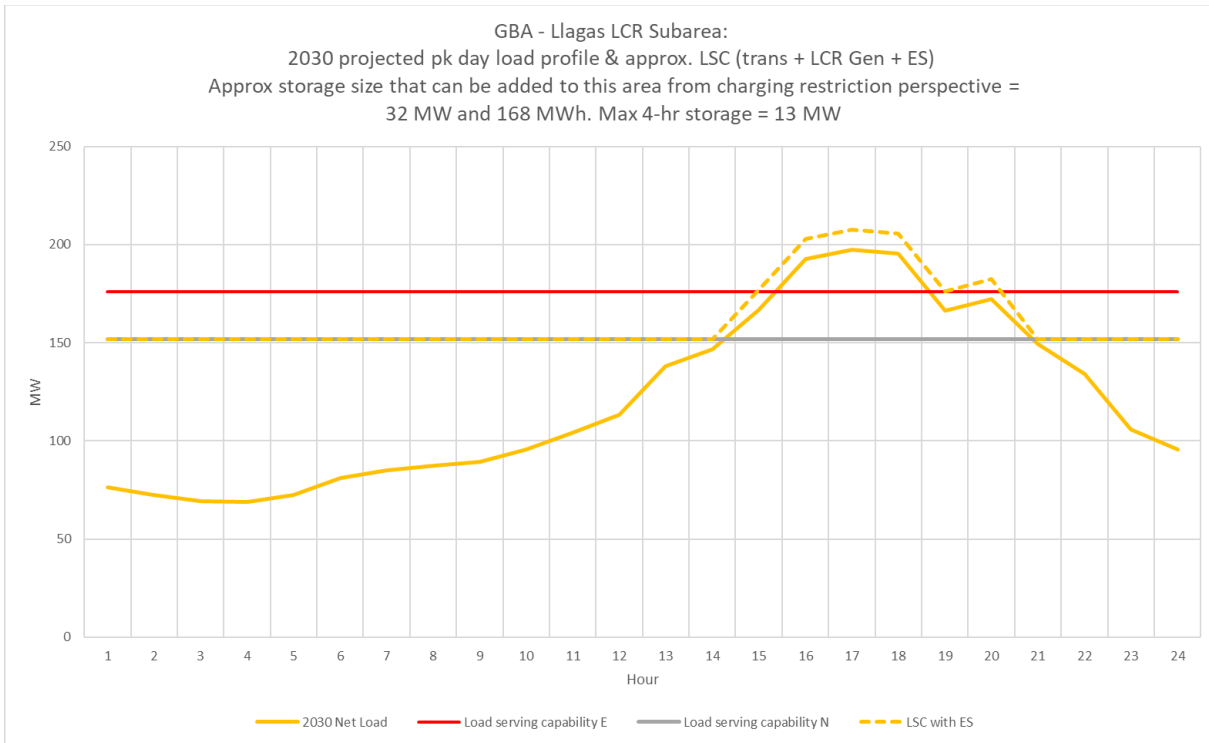
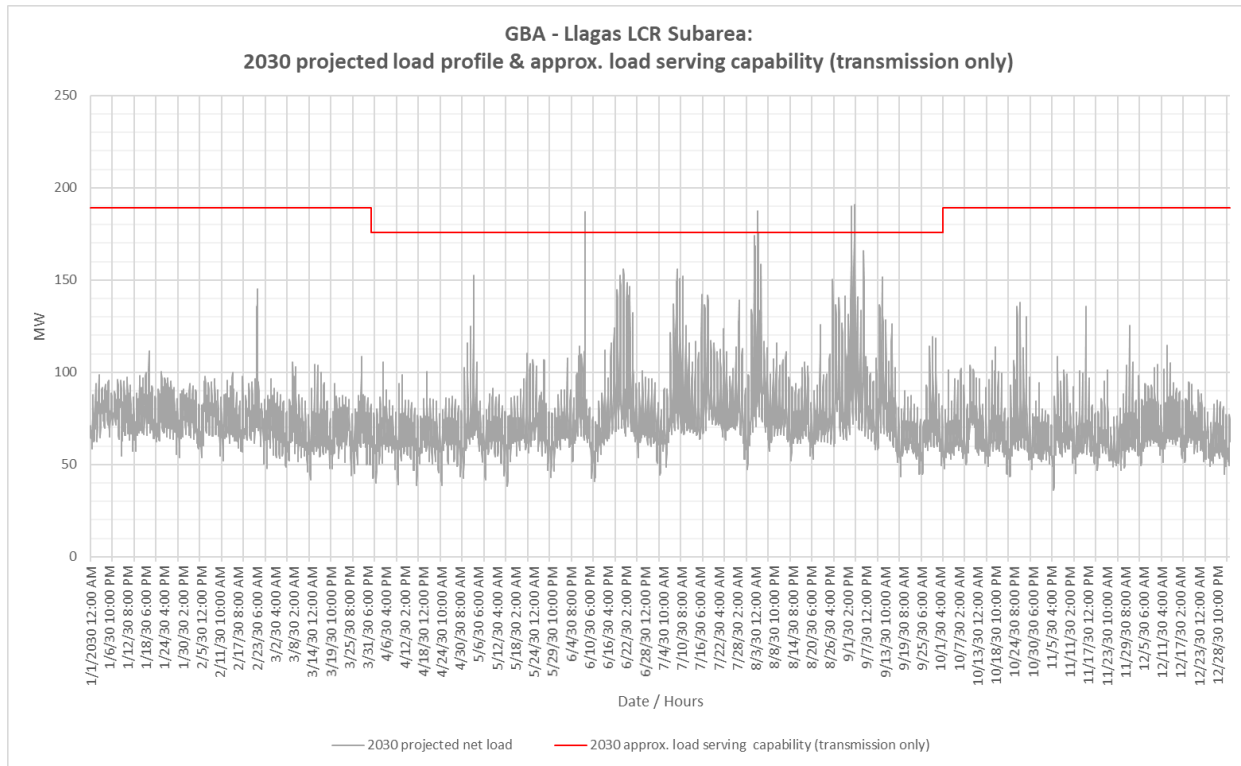

Figure 3.6-22 Llagas LCR Sub-area 2030 Forecast Hourly Profiles



3.6.5.2.4 Llagas LCR Sub-area Requirement

Table 3.6-21 identifies the sub-area LCR requirements. The LCR requirement for the Category P6 contingency is 31 MW.

Table 3.6-21 Llagas LCR Sub-area Requirements

Year	Limit	Category	Limiting Facility	Contingency	LCR (MW)
2030	First limit	P6	Morgan Hill-Llagas 115 kV line	Metcalf-Morgan Hill 115 kV & Morgan Hill-Green Valley 115 kV	31

3.6.5.2.5 Effectiveness factors:

All units within the Llagas Sub-area have the same effectiveness factor.

3.6.5.2.6 Alternatives to Reduce or Eliminate Gas Generation

As a part of the 2020-2021 transmission planning process the Llagas LCR Sub-area was not selected to assess alternatives to reduce or eliminate the requirement for gas-fired generation to address the LCR requirement.

As a part of the 2019-2020 transmission planning process the ISO undertook an assessment of the Llagas sub-area in order to determine potential transmission alternatives to reduce or eliminate the need for gas-fired generation.

3.6.5.3 San Jose Sub-area

San Jose is a sub-area of the Greater Bay LCR area.

3.6.5.3.1 San Jose LCR Sub-area Diagram

The San Jose LCR sub-area is identified in Figure 3.6-20.

3.6.5.3.2 San Jose LCR Sub-area Load and Resources

Table 3.6-22 provides the forecast load and resources in San Jose LCR sub-area in 2030. The list of generators within the LCR sub-area are provided in Attachment A.

Table 3.6-22 San Jose LCR Sub-area 2030 Forecast Load and Resources

Load (MW)		Generation (MW)	Aug NQC	At Peak
Gross Load	2,737	Market, Net Seller, Battery, Solar	575	575
AAEE	-61	MUNI	198	198
Behind the meter DG	0	QF	0	0

Net Load	2,676	LTPP Preferred Resources	75	75
Transmission Losses	76	Existing 20-minute Demand Response	0	0
Pumps	0	Mothballed	0	0
Load + Losses + Pumps	2,752	Total	848	848

3.6.5.3.3 San Jose LCR Sub-area Hourly Profiles

Figure 3.6-23 illustrates the forecast 2030 profile for the peak day for the San Jose LCR sub-area with the Category P2 normal and emergency load serving capabilities without local capacity resources. The chart also includes an estimated amount of energy storage that can be added to this local area from charging restriction perspective and the amount of 4-hour storage that can be added to replace local capacity on a 1 MW for 1 MWh basis. Figure 3.6-24 illustrates the forecast 2030 hourly profile for San Jose LCR sub-area with the Category P2 emergency load serving capability without local capacity resources.

Figure 3.6-23 San Jose LCR Sub-area 2030 Peak Day Forecast Profiles

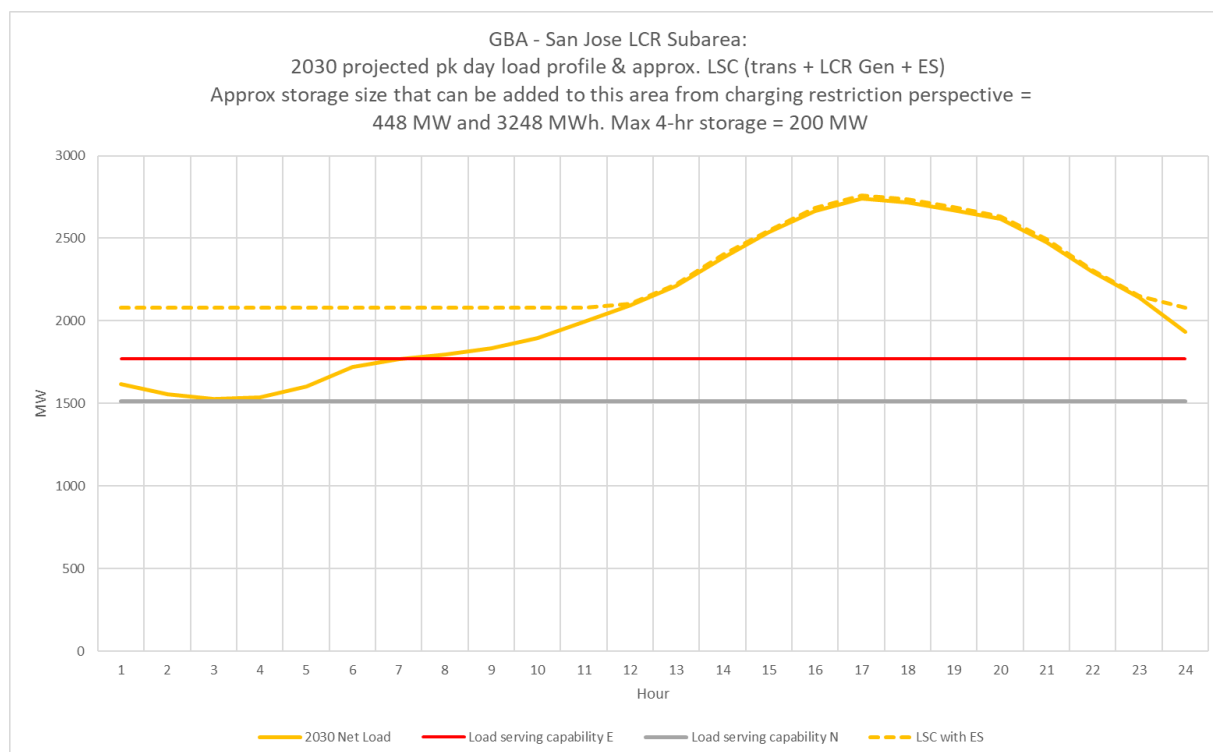
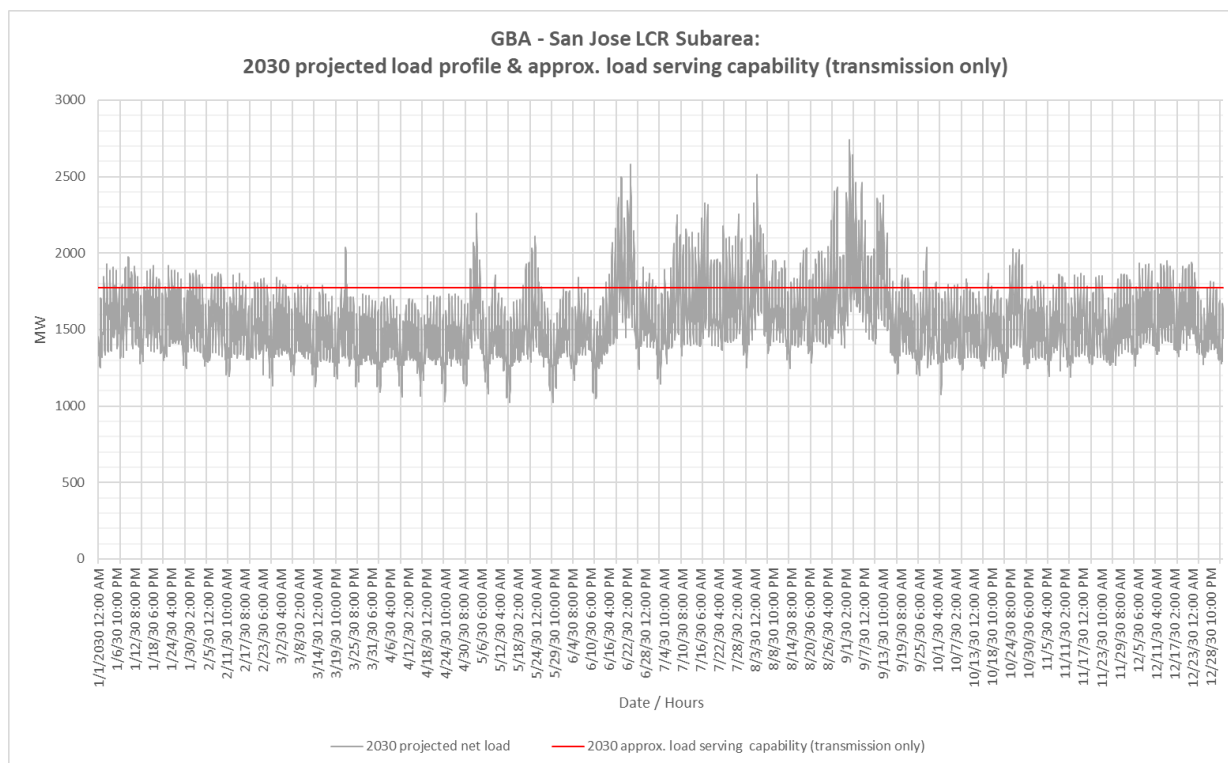

Figure 3.6-24 San Jose LCR Sub-area 2030 Forecast Hourly Profiles



3.6.5.3.4 San Jose Sub-area Requirement

Table 3.6-23 identifies the sub-area LCR requirements. The LCR requirement for the Category P2 contingency is 918 MW which includes deficiency of 70 MW.

Table 3.6-23 San Jose LCR Sub-area Requirements

Year	Limit	Category	Limiting Facility	Contingency	LCR (MW) (Deficiency)
2030	First limit	P2	Metcalf 230/115 kV transformer # 1 or # 3	Metcalf 230kV - Section 2D & 2E	918 (70)

3.6.5.3.5 Effectiveness factors:

Effectiveness factors for generators in the San Jose LCR sub-area are in Attachment B table titled [San Jose](#).

For other helpful procurement information please read procedure 2210Z Effectiveness Factors under 7320 posted at: <http://www.aiso.com/Documents/2210Z.pdf>

3.6.5.3.6 Alternatives to Reduce or Eliminate Gas Generation

As a part of the 2018-2019 transmission planning process the ISO undertook an assessment of the San Jose sub-area in order to determine potential transmission alternatives to reduce or eliminate the need for gas-fired generation.

As a part of the 2020-2021 transmission planning process the following alternatives were considered.

- Horizon West's Metcalf 230 kV substation project

Table 3.6-24 provides the LCR requirement for the alternatives identified above. For the alternatives that reduced the LCR requirement but did not eliminate the requirement, the limiting facility and contingency have been provided.

Table 3.6-24 Alternatives to Reduce or Eliminate the San Jose Sub-Area Requirement for Gas-fired generation

Year	Limit	Category	Limiting Facility	Contingency	LCR (MW) (Deficiency)
2030	Second Limit	P2	Metcalf-EI Patio 2 115 kV Line	MTCALF D Section 1D & MTCALF E Section 1E 115KV	611
With HWT-Metcalf 230 kV substation					
2030	First Limit	P2	Metcalf-EI Patio 2 115 kV Line	MTCALF D Section 1D & MTCALF E Section 1E 115KV	611

Table 3.6-25 provides the cost estimates and the total San Jose LCR Sub-area requirement and portion of requirement that would need to be supplied from gas-fired and non-gas generation for the alternatives identified above.

Table 3.6-25 Alternative Cost Estimate and LCR Requirement

Alternatives	Submitted By	Estimated Cost (\$M)	Requirement (MW)			
			Total	Market Gas	Other Gas	Non-Gas
HWT-Metcalf 230 kV substation	HWT	80	611	335	198	78

3.6.5.4 South Bay-Moss Landing Sub-area

South Bay-Moss Landing is a sub-area of the Greater Bay LCR area.

3.6.5.4.1 South Bay-Moss Landing LCR Sub-area Diagram

The South Bay-Moss Landing LCR sub-area is identified in Figure 3.6-20.

3.6.5.4.2 South Bay-Moss Landing LCR Sub-area Load and Resources

Table 3.6-26 provides the forecast load and resources in South Bay-Moss Landing LCR sub-area in 2030. The list of generators within the LCR sub-area are provided in Attachment A.

Table 3.6-26 South Bay-Moss Landing LCR Sub-area 2030 Forecast Load and Resources

Load (MW)		Generation (MW)	Aug NQC	At Peak
Gross Load	4435	Market, Net Seller, Battery, Solar	2165	2165
AAEE	-95	MUNI	198	198
Behind the meter DG	0	QF	0	0
Net Load	4,340	LTPP Preferred Resources	558	558
Transmission Losses	128	Existing 20-minute Demand Response	0	0
Pumps	0	Mothballed	0	0
Load + Losses + Pumps	4,468	Total	2921	2921

3.6.5.4.3 South Bay-Moss Landing LCR Sub-area Hourly Profiles

Figure 3.6-25 illustrates the forecast 2030 profile for the peak day for the South Bay-Moss Landing LCR sub-area with the Category P6 normal and emergency load serving capabilities without local capacity resources. The chart also includes an estimated amount of energy storage that can be added to this local area from charging restriction perspective and the amount of 4-hour storage that can be added to replace local capacity on a 1 MW for 1 MWh basis. The energy storage amount is incremental to the existing system and doesn't include approved energy storage. Figure 3.6-26 illustrates the forecast 2030 hourly profile for South Bay-Moss Landing LCR sub-area with the Category P6 emergency load serving capability without local capacity resources.

Figure 3.6-25 South Bay-Moss Landing LCR Sub-area 2030 Peak Day Forecast Profiles

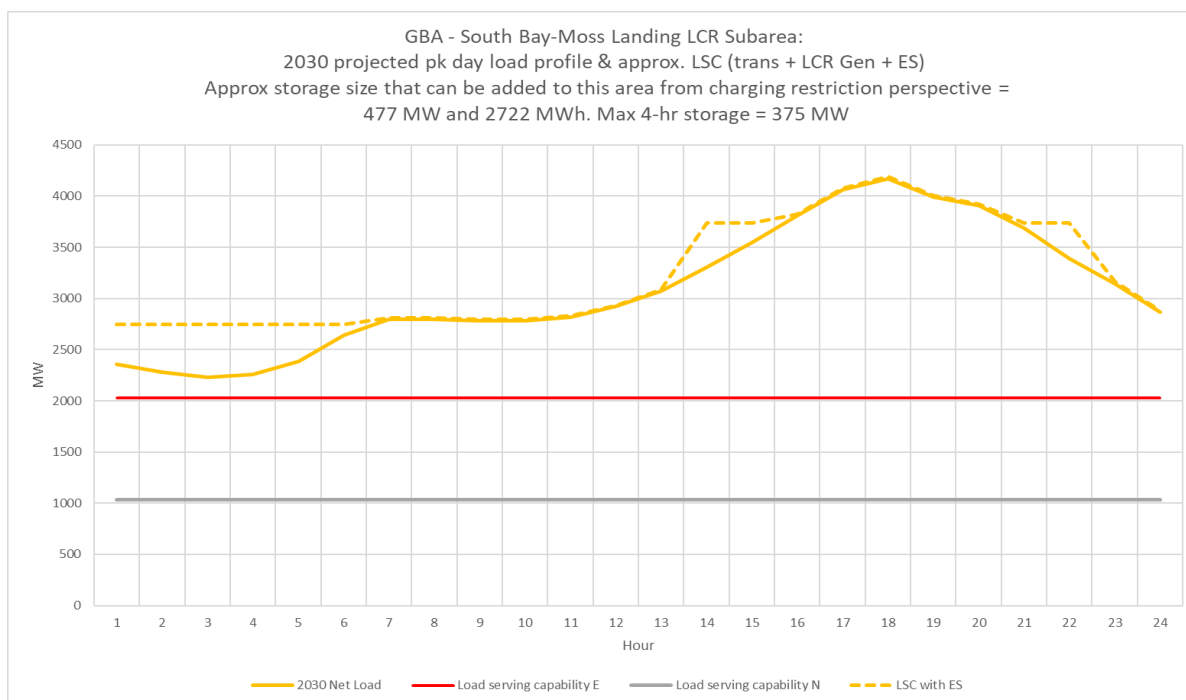
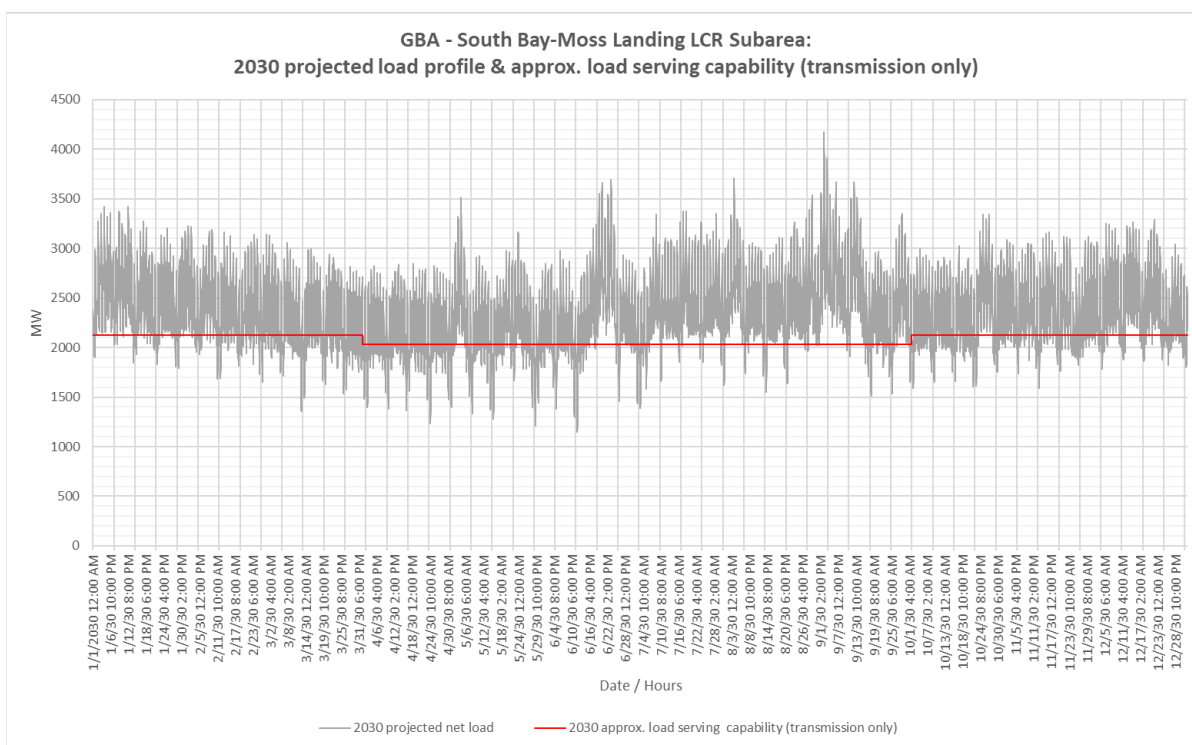

Figure 3.6-26 South Bay-Moss Landing LCR Sub-area 2030 Forecast Hourly Profiles



3.6.5.4.4 South Bay-Moss Landing LCR Sub- Requirement

Table 3.6-27 identifies the sub-area LCR requirements. The LCR requirement for the Category P6 contingency is 2185 MW.

Table 3.6-27 South Bay-Moss Landing LCR Sub-area Requirements

Year	Limit	Category	Limiting Facility	Contingency	LCR (MW)
2025	First Limit	P6	Moss Landing-Las Aguilas 230 kV	Tesla-Metcalf 500 kV and Moss Landing-Los Banos 500 kV	2185

3.6.5.4.5 Effectiveness factors:

Effectiveness factors for generators in the South Bay-Moss Landing LCR sub-area are in Attachment B table titled [South Bay-Moss Landing](#).

For other helpful procurement information please read procedure 2210Z Effectiveness Factors under 7230 posted at: <http://www.aiso.com/Documents/2210Z.pdf>

3.6.5.4.6 Alternatives to Reduce or Eliminate Gas Generation

In the 2020-2021 transmission planning process the South Bay-Moss Landing LCR sub-area was not selected to assess alternatives to reduce or eliminate the requirement for gas-fired generation to address the LCR requirement.

As a part of the 2018-2019 transmission planning process the ISO undertook an assessment of the South Bay-Moss Landing sub-area in order to determine potential transmission alternatives to reduce or eliminate the need for gas-fired generation.

3.6.5.5 Oakland Sub-area

Oakland is a sub-area of the Greater Bay LCR area.

3.6.5.5.1 Oakland LCR Sub-area Diagram

Figure 3.6-27 Oakland LCR Sub-area

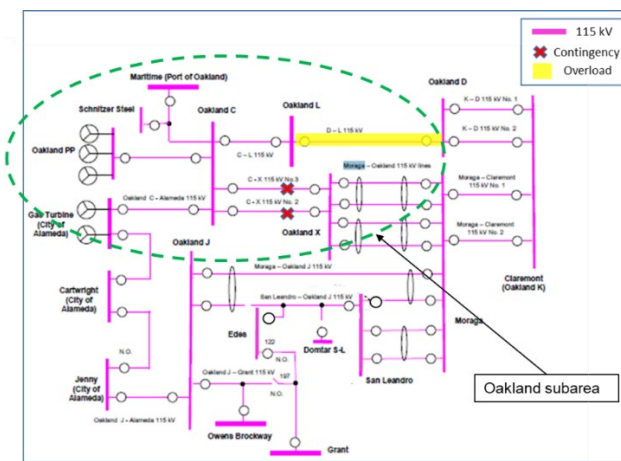

3.6.5.5.2 Oakland LCR Sub-area Load and Resources

Table 3.6-28 provides the forecast load and resources in Oakland LCR sub-area in 2030. The list of generators within the LCR sub-area are provided in Attachment A.

Table 3.6-28 Oakland LCR Sub-area 2030 Forecast Load and Resources

Load (MW)		Generation (MW)	Aug NQC	At Peak
Gross Load	193	Market, Net Seller, Battery, Solar	0	0
AAEE	-4	MUNI	48	48
Behind the meter DG	0	QF	0	0
Net Load	189	LTPP Preferred Resources	36	36
Transmission Losses	0	Existing 20-minute Demand Response	0	0
Pumps	0	Mothballed	0	0
Load + Losses + Pumps	189	Total	84	84

3.6.5.5.3 Oakland LCR Sub-area Hourly Profiles

Figure 3.6-28 illustrates the forecast 2030 profile for the peak day for the Oakland LCR sub-area with the Category P6 normal and emergency load serving capabilities without local capacity resources. The chart also includes an estimated amount of energy storage that can be added to this local area from charging restriction perspective and the amount of 4-hour storage that can be added to replace local capacity on a 1 MW for 1 MW basis. Figure 3.6-29 illustrates the forecast 2030 hourly profile for Oakland LCR sub-area with the Category P6 emergency load serving capability without local capacity resources.

Figure 3.6-28 Oakland LCR Sub-area 2030 Peak Day Forecast Profiles

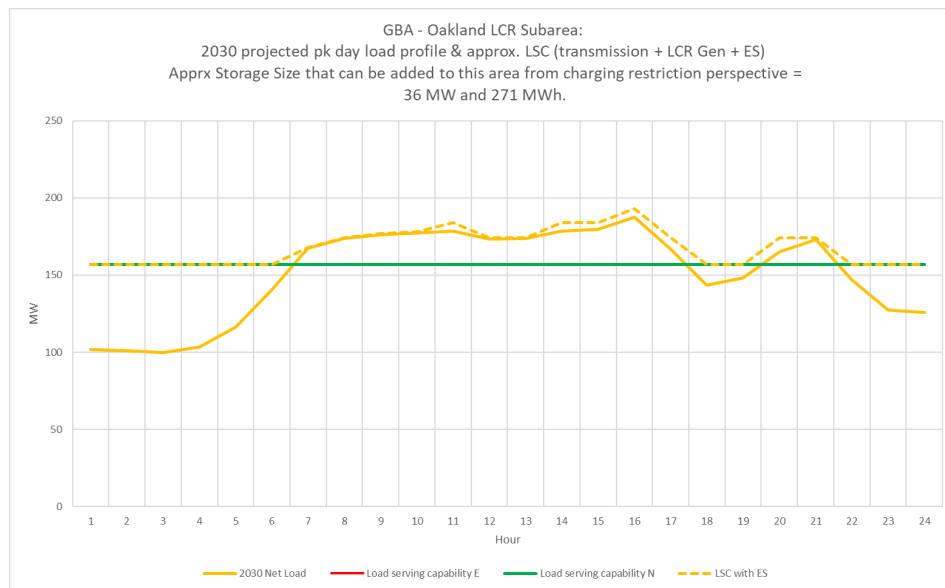
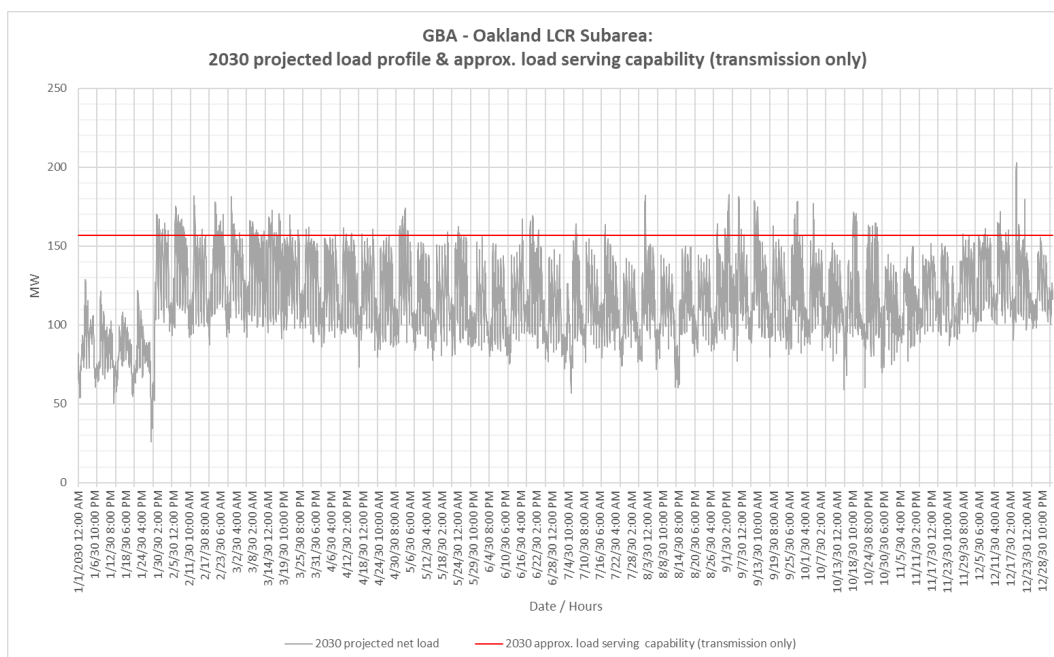

Figure 3.6-29 Oakland LCR Sub-area 2030 Forecast Hourly Profiles



3.6.5.5.4 Oakland LCR Sub-area Requirement

Table 3.6-29 identifies the sub-area requirements. The LCR requirement for the Category P6 contingency is 36 MW.

Table 3.6-29 Oakland LCR Sub-area Requirements

Year	Limit	Category	Limiting Facility	Contingency	LCR (MW)
2030	First limit	P6	Oakland D-L 115 kV	Oakland C-X #2 & #3 115 kV cables	36 ⁴

3.6.5.5.5 Effectiveness factors:

All units within the Oakland sub-area have the same effectiveness factor.

For most helpful procurement information please read procedure 2210Z Effectiveness Factors under 7320 posted at: <http://www.caiso.com/Documents/2210Z.pdf>

3.6.5.5.6 Alternatives to Reduce or Eliminate Gas Generation

In the 2020-2021 transmission planning process the Oakland LCR Sub-area was not selected to assess alternatives to reduce or eliminate the requirement for gas-fired generation to address the LCR requirement.

⁴ This requirement doesn't reflect potential load transfer that could occur following the first contingency. An approved operating procedure including this load transfer could reduce this requirement.

As a part of the 2019-2020 transmission planning process the ISO undertook an assessment of the Oakland sub-area in order to determine potential transmission alternatives to reduce or eliminate the need for gas-fired generation.

3.6.5.6 Ames-Pittsburg-Oakland Sub-areas Combined

Ames-Pittsburg-Oakland is a sub-area of the Greater Bay LCR area.

3.6.5.6.1 Ames-Pittsburg-Oakland LCR Sub-area Diagram

Figure 3.6-30 Ames-Pittsburg-Oakland LCR Sub-area

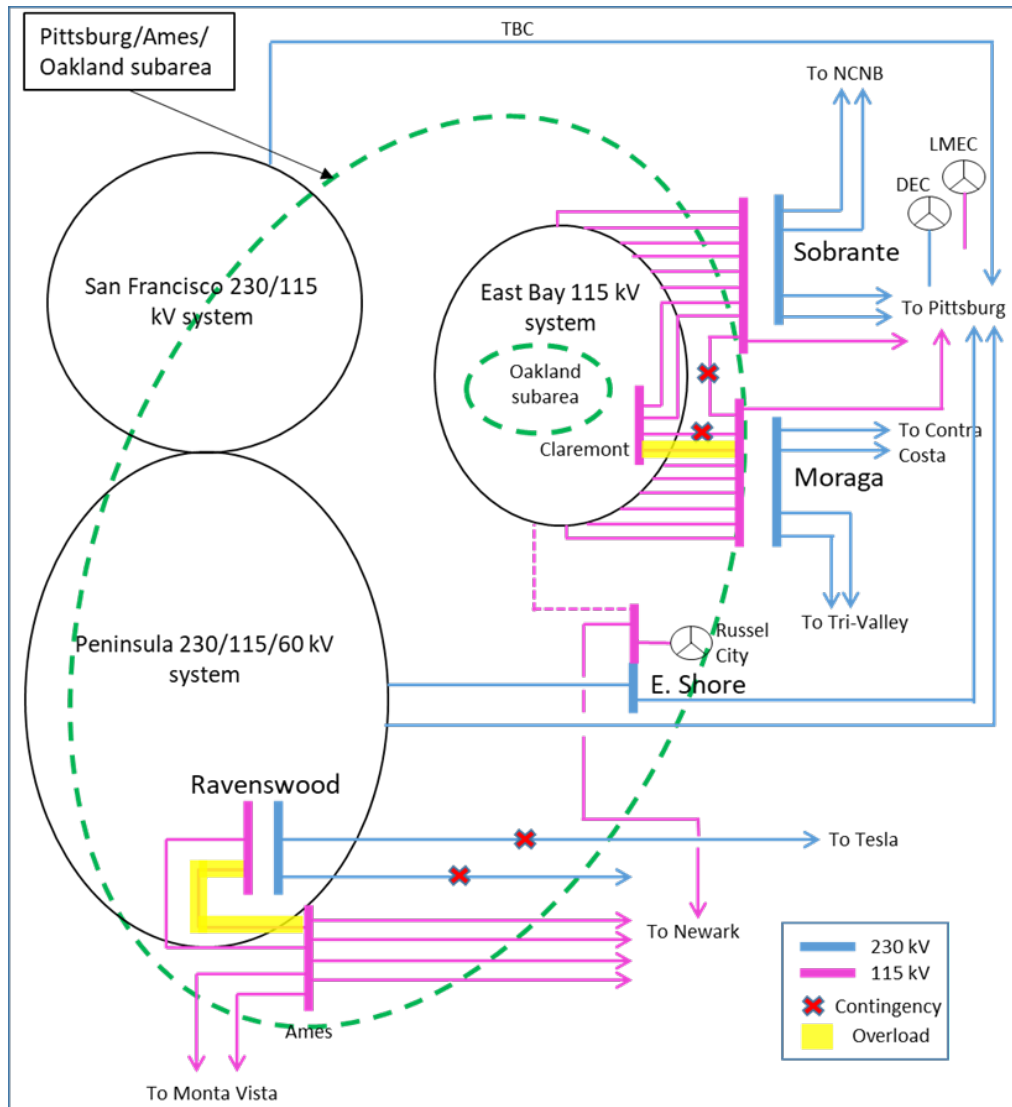

3.6.5.6.2 Ames-Pittsburg-Oakland LCR Sub-area Load and Resources

Table 3.6-30 provides the forecast load and resources in Ames-Pittsburg-Oakland LCR sub-area in 2030. The list of generators within the LCR sub-area are provided in Attachment A.

Table 3.6-30 Ames-Pittsburg-Oakland LCR Sub-area 2030 Forecast Load and Resources

Load (MW)	Generation (MW)	Aug NQC	At Peak
The Ames-Pittsburg-Oakland Sub-area does not has a defined load pocket with the limits based upon power flow through the area.	Market, Net Seller, Battery, Wind	2152	2152
	MUNI	48	48
	QF	225	225
	Solar	5	5
	Existing 20-minute Demand Response	0	0
	LTPP Preferred Resources	36	36
	Total	2466	2466

3.6.5.6.3 Ames-Pittsburg-Oakland LCR Sub-area Hourly Profiles

The Ames-Pittsburg-Oakland sub-area does not has a defined load pocket with the limits based upon power flow through the area. As such, no load profile is provided for this sub-area.

3.6.5.6.4 Ames-Pittsburg-Oakland LCR Sub-area Requirement

Table 3.6-31 identifies the sub-area LCR requirements. The LCR requirement for the Category P7 or P2 contingency is 1643 MW.

Table 3.6-31 Ames-Pittsburg-Oakland LCR Sub-area Requirements

Year	Limit	Category	Limiting Facility	Contingency	LCR (MW)
2030	First limit	P7	Ames-Ravenswood #1 115 kV line	Newark-Ravenswood 230 kV & Tesla-Ravenswood 230 kV	1643
		P2	Martinez-Sobrante 115 kV line	Pittsburg Section 1D & 1E 230 kV	

3.6.5.6.5 Effectiveness factors:

Effectiveness factors for generators in the Ames-Pittsburg-Oakland LCR sub-area are in Attachment B table titled [Ames/Pittsburg/Oakland](#).

For other helpful procurement information please read procedure 2210Z Effectiveness Factors under 7320 (T-165Z) posted at: <http://www.caiso.com/Documents/2210Z.pdf>

3.6.5.6.6 Alternatives to Reduce or Eliminate Gas Generation

In the 2020-2021 transmission planning process the Ames-Pittsburg-Oakland LCR sub-area was not selected to assess alternatives to reduce or eliminate the requirement for gas-fired generation to address the LCR requirement.

As a part of the 2018-2019 transmission planning process the ISO undertook an assessment of the Ames-Pittsburg-Oakland sub-area in order to determine potential transmission alternatives to reduce or eliminate the need for gas-fired generation.

3.6.5.7 Contra Costa Sub-area

Contra Costa is a sub-area of the Greater Bay LCR area.

3.6.5.7.1 Contra Costa LCR Sub-area Diagram

Figure 3.6-31 Contra Costa LCR Sub-area

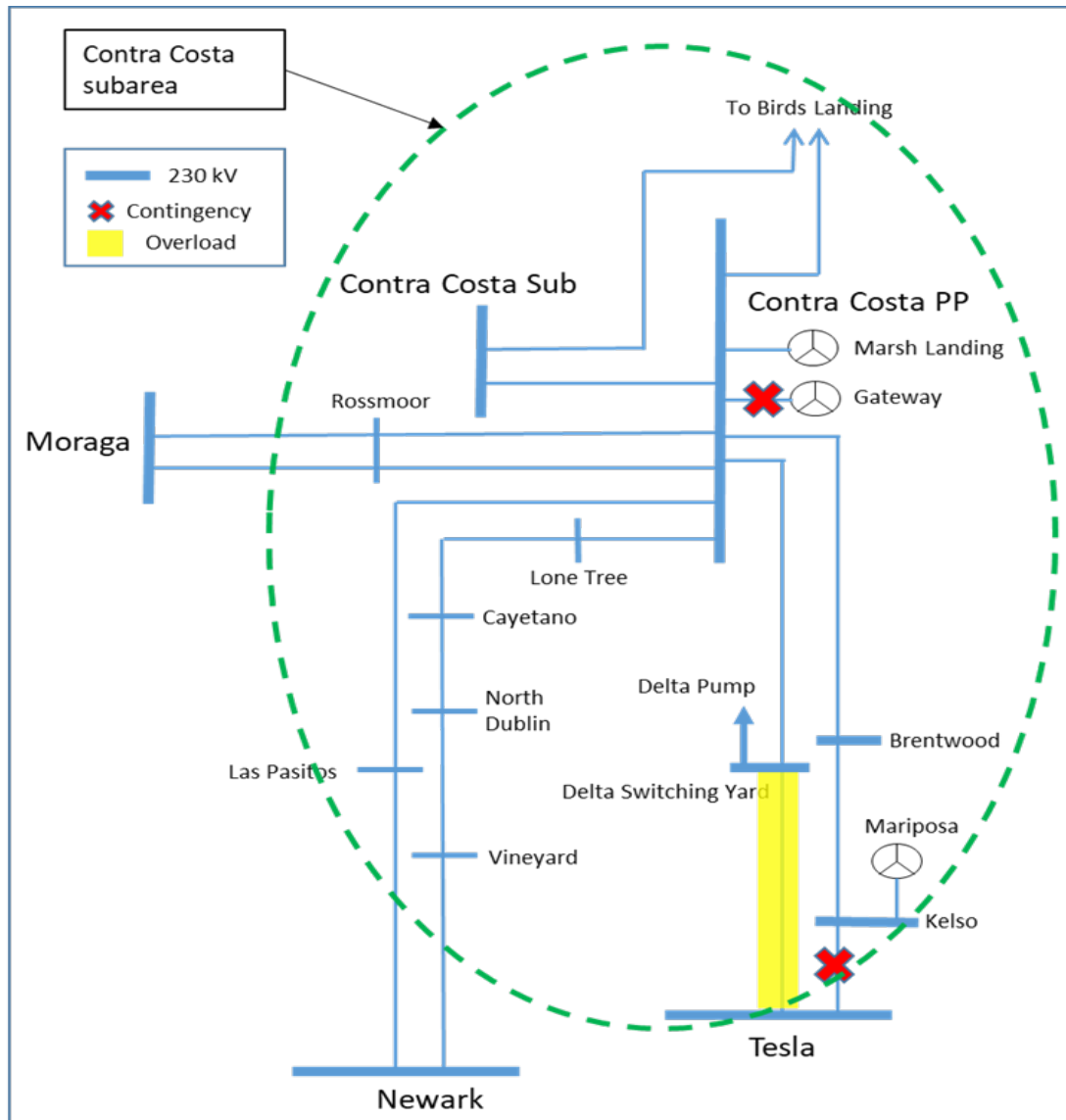

3.6.5.7.2 Contra Costa LCR Sub-area Load and Resources

Table 3.6-32 provides the forecast load and resources in Contra Costa LCR sub-area in 2030. The list of generators within the LCR sub-area are provided in Attachment A.

Table 3.6-32 Contra Costa LCR Sub-area 2030 Forecast Load and Resources

Load (MW)	Generation (MW)	Aug NQC	At Peak
The Contra Costa Sub-area does not have a defined load pocket with the limits based upon power flow through the area.	Market, Net Seller, Battery, Solar	1669	1669
	MUNI	127	127
	QF	0	0
	Wind	244	244
	Existing 20-minute Demand Response	0	0
	Mothballed	0	0
	Total	2040	2040

3.6.5.7.3 Contra Costa LCR Sub-area Hourly Profiles

The Contra Costa sub-area does not have a defined load pocket with the limits based upon power flow through the area. As such, no load profile is provided for this sub-area.

3.6.5.7.4 Contra Costa LCR Sub-area Requirement

Table 3.6-33 identifies the sub-area LCR requirements. The LCR requirement for the Category P6 contingency is 1460 MW.

Table 3.6-33 Contra Costa LCR Sub-area Requirements

Year	Limit	Category	Limiting Facility	Contingency	LCR (MW)
2030	First limit	P3	Delta Switching Yard-Tesla 230 kV	Kelso-Tesla 230 kV line and Gateway unit	1460

3.6.5.7.5 Effectiveness factors:

For other helpful procurement information please read procedure 2210Z Effectiveness Factors under 7230 posted at: <http://www.caiso.com/Documents/2210Z.pdf>

3.6.5.7.6 Alternatives to Reduce or Eliminate Gas Generation

As a part of the 2019-2020 transmission planning process the ISO undertook an assessment of the Contra Costa sub-area in order to determine potential transmission alternatives to reduce or eliminate the need for gas-fired generation.

As a part of the 2020-2021 transmission planning process the following alternatives were considered.

- Contra Costa – Pittsburg 230 kV Reliability Project

- Tesla – Delta Switchyard 230 kV line reactance

Table 3.6-34 provides the LCR requirement for the alternatives identified above. For the alternatives that reduced the LCR requirement but did not eliminate the requirement, the limiting facility and contingency have been provided.

Table 3.6-34 Alternatives to Reduce or Eliminate the Contra Costa Sub-Area Requirement for Gas-fired generation

Year	Limit	Category	Limiting Facility	Contingency	LCR (MW) (Deficiency)
Contra Costa – Pittsburg 230 kV Reliability Project					
2030	First Limit	P3	Delta Switching Yard-Tesla 230 kV Line	Kelso-Tesla 230 kV with the Gateway off line	>1460 ⁵
Tesla – Delta Switchyard 230 kV line reactance					
2030	First Limit	P3	None	None	0

Table 3.6-35 provides the cost estimates and the total Contra Costa LCR Sub-area requirement and portion of requirement that would need to be supplied from gas-fired and non-gas generation for the alternatives identified above.

Table 3.6-35 Alternative Cost Estimate and LCR Requirement

Alternatives	Submitted By	Estimated Cost (\$M)	Requirement (MW)			
			Total	Market Gas	Other Gas	Non-Gas
Contra Costa-Pittsburg 230 kV Reliability Project	HWT	200	>1460	N/A	N/A	N/A
Tesla – Delta Switchyard 230 kV line reactance	Smart Wires	7.7-14.4	0	0	0	0

The Tesla-Delta Switchyard 230 kV line reactance project eliminates the Contra Costa sub-area LCR requirement. However, based on the latest publically available 2018 RA prices and the benefit cost ratio analysis done in chapter 4 this project only provides marginal benefit for this area. For this reason, the alternative is not recommended for approval at this time.

⁵ Contra Costa – Pittsburg 230 kV Reliability Project increases the requirement as the overload increases by significant amount post project. The new requirements were not calculated for this project.

3.6.5.8 Bay Area overall

3.6.5.8.1 Bay Area LCR Area Hourly Profiles

Figure 3.6-32 illustrates the forecast 2030 profile for the peak day for the Bay Area LCR area with the Category P6 normal and emergency load serving capabilities without local capacity resources. The chart also includes an estimated amount of energy storage that can be added to this local area from charging restriction perspective and the amount of 4-hour storage that can be added to replace local capacity on a 1 MW for 1 MWh basis. Figure 3.6-33 illustrates the forecast 2030 hourly profile for Bay Area LCR area with the Category P6 emergency load serving capability without local capacity resources.

Figure 3.6-32 Bay Area LCR Area 2030 Peak Day Forecast Profiles

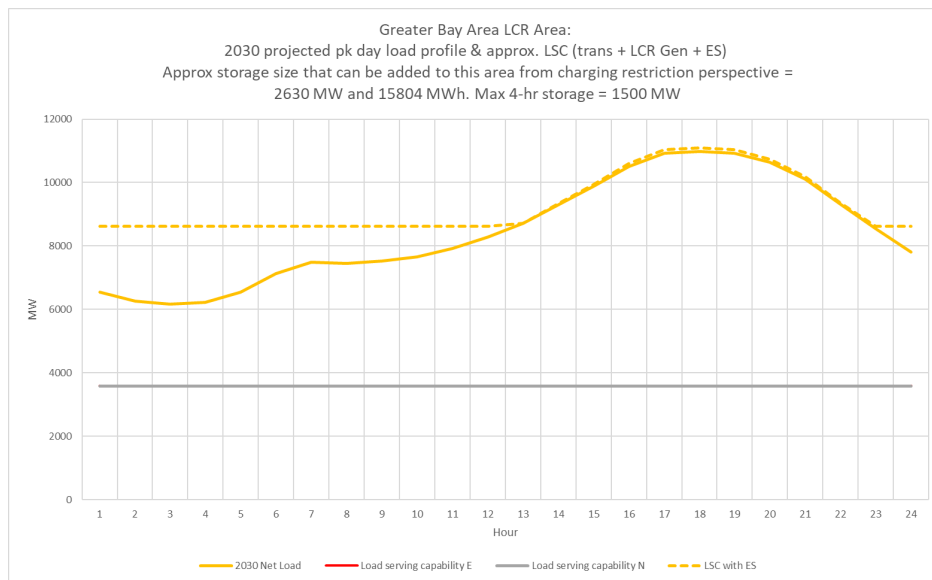
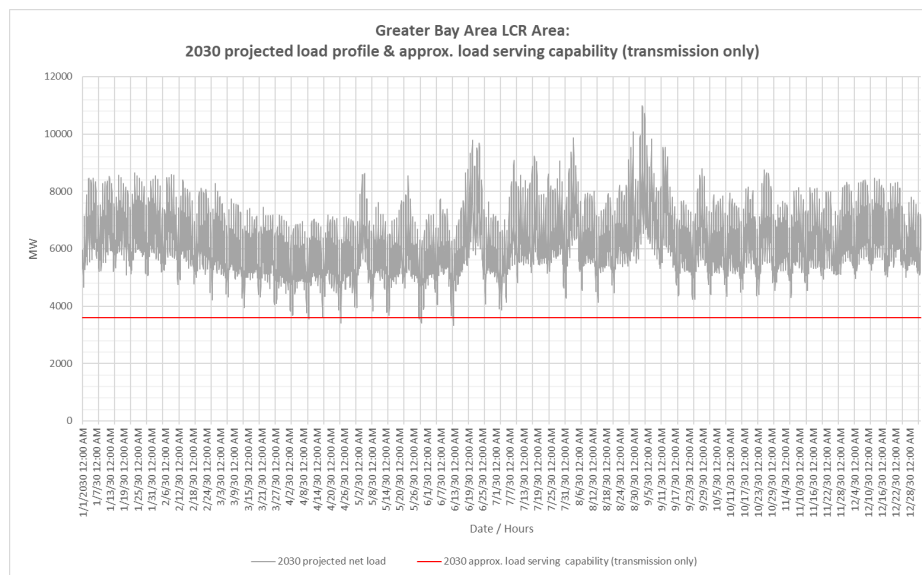

Figure 3.6-33 Bay Area LCR Area 2030 Forecast Hourly Profiles



3.6.5.8.2 Greater Bay LCR Area Overall Requirement

Table 3.6-36 identifies the area LCR requirements. The LCR requirement for the Category P6 contingency is 7455 MW.

Table 3.6-36 Bay Area LCR Overall area Requirements

Year	Limit	Category	Limiting Facility	Contingency	LCR (MW)
2030	First limit	P6	Metcalf 500/230 kV #13 transformer	Metcalf 500/230 kV #11 & #12 transformers	7455 (111)

3.6.5.8.3 Changes compared to the 2025 LCT study

Load forecast went up by 452 MW and total LCR need went up by 1345 MW mainly due to the load increase and higher S-N flow on Path 15.

3.6.5.8.4 Alternatives to Reduce or Eliminate Gas Generation

As a part of the 2018-2019 and 2019-2020 transmission planning process the ISO undertook an assessment of the Bay Area in order to determine potential transmission alternatives to reduce or eliminate the need for gas-fired generation.

As a part of the 2020-2021 transmission planning process the following alternatives were considered.

- Metcalf 500/230kV transformer dynamic series reactor project

Table 3.6-37 provides the LCR requirement for the alternatives identified above. For the alternatives that reduced the LCR requirement but did not eliminate the requirement, the limiting facility and contingency have been provided.

Table 3.6-37 Alternative to Reduce or Eliminate Greater Bay Requirement for Gas-fired generation

Year	Limit	Category	Limiting Facility	Contingency	LCR (MW) (Deficiency)
2030	Second Limit		Aggregate of sub-areas		5358 (70)
With Metcalf 500/230 KV Transformers Dynamic Series Reactor Project					
2030	First Limit		Aggregate of sub-areas		5358 (70)

The Metcalf 500/230kV transformer dynamic series reactor project eliminates the largest bay area LCR requirement. However, based on the latest publically available 2018 RA prices and the benefit cost ratio analysis done in chapter 4 this project only provides marginal benefit for this area. For this reason, the alternative is not recommended for approval at this time.

Table 3.6-38 provides the cost estimate and the total Grater Bay LCR Area overall requirement and portion of requirement that would need to be supplied from gas-fired and non-gas generation for the alternative identified above.

Table 3.6-38 Alternative Cost Estimate and LCR Requirement

Alternatives	Submitted By	Estimated Cost (\$M)	Requirement (MW)			
			Total	Market Gas	Other Gas	Non-Gas
Metcalf 500/230 KV Transformers Dynamic Series Reactor Project	PG&E	32	5288	3634	688	966

3.6.6 Greater Fresno Area

3.6.6.1 Area Definition:

The transmission facilities coming into the Greater Fresno area are:

- Gates-Mustang #1 230 kV
- Gates-Mustang #2 230 kV
- Gates #5 230/70 kV Transformer Bank
- Mercy Spring 230 /70 Bank # 1
- Los Banos #3 230/70 Transformer Bank
- Los Banos #4 230/70 Transformer Bank
- Warnerville-Wilson 230kV
- Melones-North Merced 230 kV line
- Panoche-Tranquility #1 230 kV
- Panoche-Tranquility #2 230 kV
- Panoche #1 230/115 kV Transformer Bank
- Panoche #2 230/115 kV Transformer Bank
- Corcoran-Smyrna 115kV
- Coalinga #1-San Miguel 70 kV

The substations that delineate the Greater Fresno area are:

- Gates is out Mustang is in
- Gates is out Mustang is in
- Gates 230 is out Gates 70 is in

Mercy Springs 230 is out Mercy Springs 70 is in
 Los Banos 230 is out Los Banos 70 is in
 Los Banos 230 is out Los Banos 70 is in
 Warnerville is out Wilson is in
 Melones is out North Merced is in
 Panoche is out Tranquility #1 is in
 Panoche is out Tranquility #2 is in
 Panoche 230 is out Panoche 115 is in
 Panoche 230 is out Panoche 115 is in
 Corcoran is in Smyrna is out
 Coalinga is in San Miguel is out

3.6.6.1.1 Fresno LCR Area Diagram

Figure 3.6-34 Fresno LCR Area

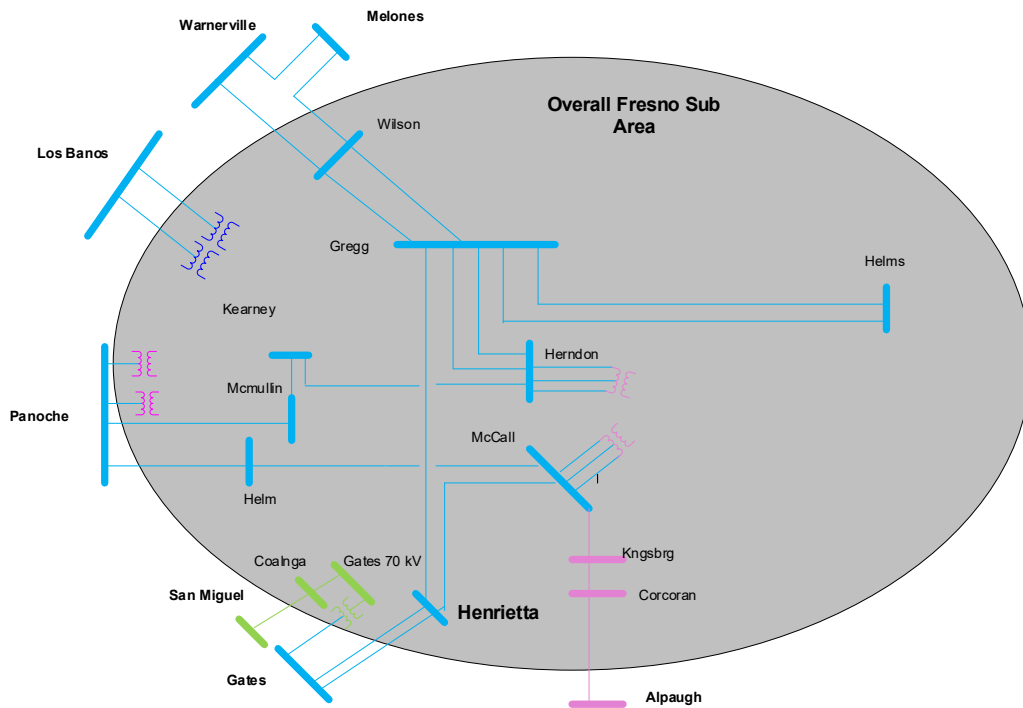

3.6.6.1.2 Fresno LCR Area Load and Resources

Table 3.6-39 provides the forecast load and resources in Fresno LCR Area in 2030. The list of generators within the LCR sub-area are provided in Attachment A.

In year 2030 the estimated time of local area peak is 18:40 PM.

At the local area peak time the estimated, ISO metered, solar output is 12.00%.

If required, all non-solar technology type resources are dispatched at NQC.

Table 3.6-39 Fresno LCR Area 2030 Forecast Load and Resources

Load (MW)		Generation (MW)	Aug NQC	At Peak
Gross Load	3537	Market, Net Seller, Battery	2815	2815
AAEE	-76	MUNI	212	212
Behind the meter DG	0	QF	4	4
Net Load	3461	Solar	361	160
Transmission Losses	128	Existing 20-minute Demand Response	0	0
Pumps	0	Mothballed	0	0
Load + Losses + Pumps	3589	Total	3392	3191

3.6.6.1.3 Approved transmission projects modeled

Wilson 115 kV SVC (May 2021)

Gregg-Herndon #2 230 kV Line Circuit Breaker Upgrade (Jan 2020)

Northern Fresno 115 kV Reinforcement (Revised scope – Jan 2021)

Wilson-Legrand 115 kV Reconductoring (April 2021)

Panoche-Oro Loma 115 kV Reconductoring (July 2022)

Oro Loma 70 kV Reinforcement (April 2024)

Reedley 70 kV Reinforcement Projects (May 2022)

Herndon-Bullard Reconductoring Projects (April 2022)

Kingsburg-Lemoore 70 kV Line Reconductoring (March 2022)

Giffen Line Reconductoring (April 2024)

Borden 230/70 kV Transformer Bank #1 Capacity Increase (Jan 2025)

Wilson-Oro Loma 115 kV Line Reconductoring (Jan 2026)

Wilson 115 kV Area Reinforcement (May 2023)

Bellota-Warnerville 230 kV Line Reconductoring (March 2024)

3.6.6.2 Hanford Sub-area

Hanford is a sub-area of the Fresno LCR area.

3.6.6.2.1 Hanford LCR Sub-area Diagram

Figure 3.6-35 Hanford LCR Sub-area

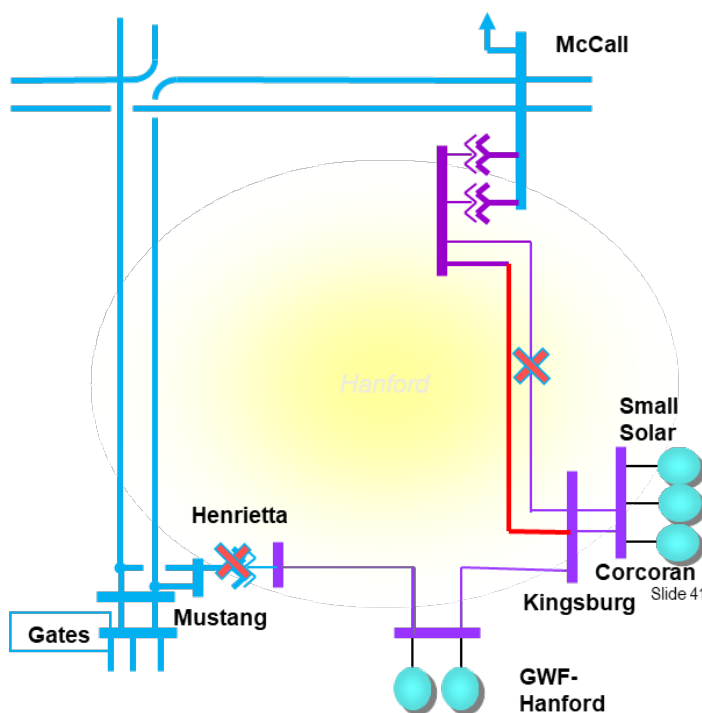

3.6.6.2.2 Hanford LCR Sub-area Load and Resources

Table 3.6-40 provides the forecast load and resources in Hanford LCR sub-area in 2030. The list of generators within the LCR sub-area are provided in Attachment A.

Table 3.6-40 Hanford LCR Sub-area 2030 Forecast Load and Resources

Load (MW)		Generation (MW)	Aug NQC	At Peak
Gross Load	217	Market, Net Seller, Battery	125	125
AAEE	-4	MUNI	0	0
Behind the meter DG	0	QF	0	0
Net Load	213	Solar	25	11
Transmission Losses	5	Existing 20-minute Demand Response	0	0

Pumps	0	Mothballed	0	0
Load + Losses + Pumps	218	Total	150	136

3.6.6.2.3 Hanford LCR Sub-area Hourly Profiles

Figure 3.6-36 illustrates the forecast 2030 profile for the peak day for the Hanford LCR sub-area with the Category P6 normal and emergency load serving capabilities without local capacity resources. The chart also includes an estimated amount of energy storage that can be added to this local area from charging restriction perspective and the amount of 4-hour storage that can be added to replace local capacity on a 1 MW for 1 MWh basis. Figure 3.6-37 illustrates the forecast 2030 hourly profile for Hanford LCR sub-area with the Category P6 emergency load serving capability without local capacity resources.

Figure 3.6-36 Hanford LCR Sub-area 2030 Peak Day Forecast Profiles

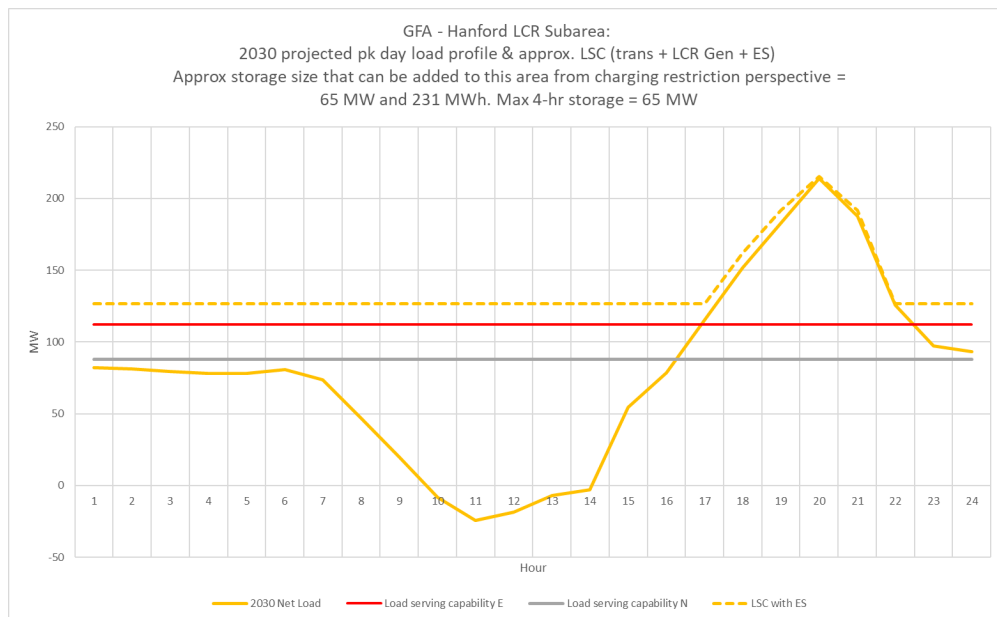
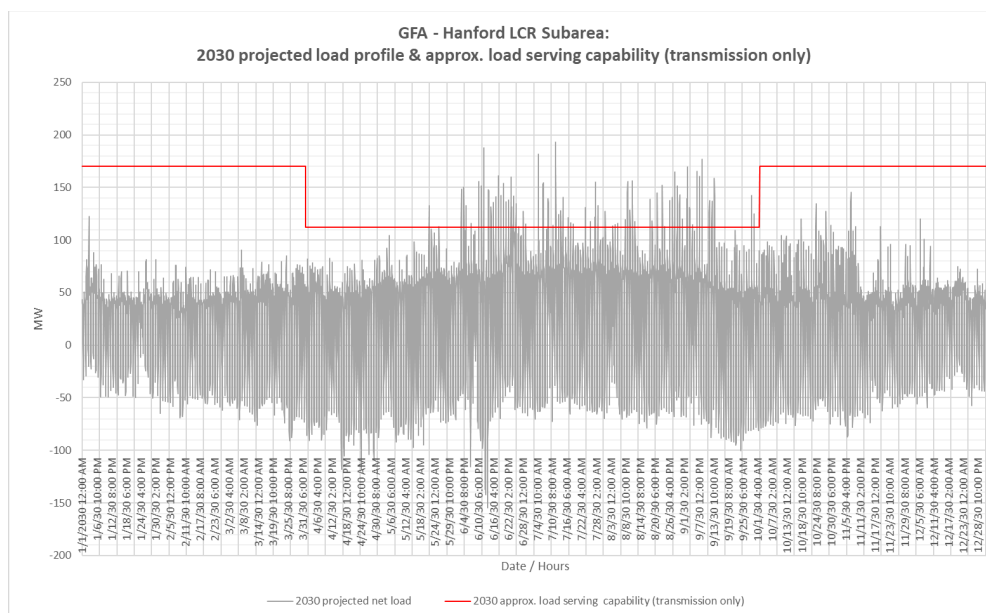

Figure 3.6-37 Hanford LCR Sub-area 2030 Forecast Hourly Profiles



3.6.6.2.4 Hanford LCR Sub-area Requirement

Table 3.6-41 identifies the sub-area requirements. The LCR Requirement for a Category P6 contingency is 69 MW.

Table 3.6-41 Hanford LCR Sub-area Requirements

Year	Limit	Category	Limiting Facility	Contingency	LCR (MW) (Deficiency)
2030	First Limit	P6	McCall-Kingsburg #2 115 kV	McCall-Kingsburg #1 115kV line and Henrietta 230/115kV TB#3	69

3.6.6.2.5 Effectiveness factors:

All units within the Hanford sub-area have the same effectiveness factor.

For most helpful procurement information please read procedure 2210Z Effectiveness Factors under 7430 posted at: <http://www.aiso.com/Documents/2210Z.pdf>

3.6.6.2.6 Alternatives to Reduce or Eliminate Gas Generation

In the 2020-2021 transmission planning process the Hanford LCR sub-area was not selected to assess alternatives to reduce or eliminate the requirement for gas-fired generation to address the LCR requirement.

As a part of the 2018-2019 transmission planning process the ISO undertook an assessment of the Hanford sub-area in order to determine potential transmission alternatives to reduce or eliminate the need for gas-fired generation.

3.6.6.3 Coalinga Sub-area

Coalinga is a sub-area of the Fresno LCR area.

3.6.6.3.1 Coalinga LCR Sub-area Diagram

Figure 3.6-38 Coalinga LCR Sub-area

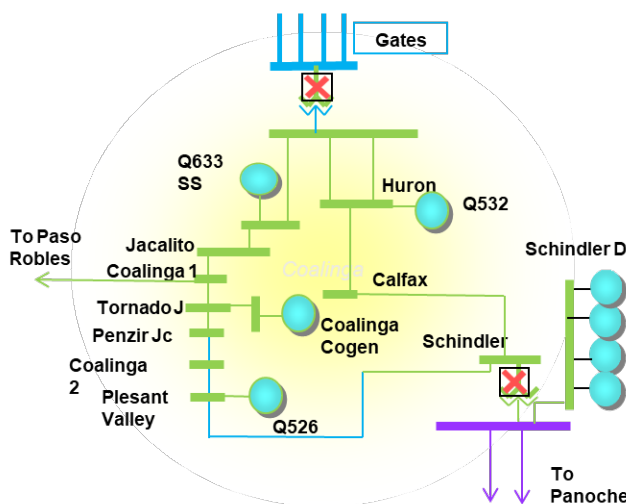

3.6.6.3.2 Coalinga LCR Sub-area Load and Resources

Table 3.6-42 provides the forecast load and resources in Coalinga LCR sub-area in 2030. The list of generators within the LCR sub-area are provided in Attachment A.

Table 3.6-42 Coalinga LCR Sub-area 2030 Forecast Load and Resources

Load (MW)		Generation (MW)	Aug NQC	At Peak
Gross Load	117	Market, Net Seller, Battery	0	0
AAEE	-2	MUNI	0	0
Behind the meter DG	0	QF	3	3
Net Load	115	Solar	13	6
Transmission Losses	2	Existing 20-minute Demand Response	0	0
Pumps	0	Mothballed	0	0
Load + Losses + Pumps	117	Total	16	9

3.6.6.3.3 Coalinga LCR Sub-area Hourly Profiles

Figure 3.6-39 illustrates the forecast 2030 profile for the peak day for the Coalinga LCR sub-area with the Category P6 normal and emergency load serving capabilities without local capacity resources. The chart also includes an estimated amount of energy storage that can be added to

this local area from charging restriction perspective and the amount of 4-hour storage that can be added to replace local capacity on a 1 MW for 1 MW basis. Figure 3.6-40 illustrates the forecast 2030 hourly profile for Coalinga LCR sub-area with the Category P6 emergency load serving capability without local capacity resources.

Figure 3.6-39 Coalinga LCR Sub-area 2030 Peak Day Forecast Profiles

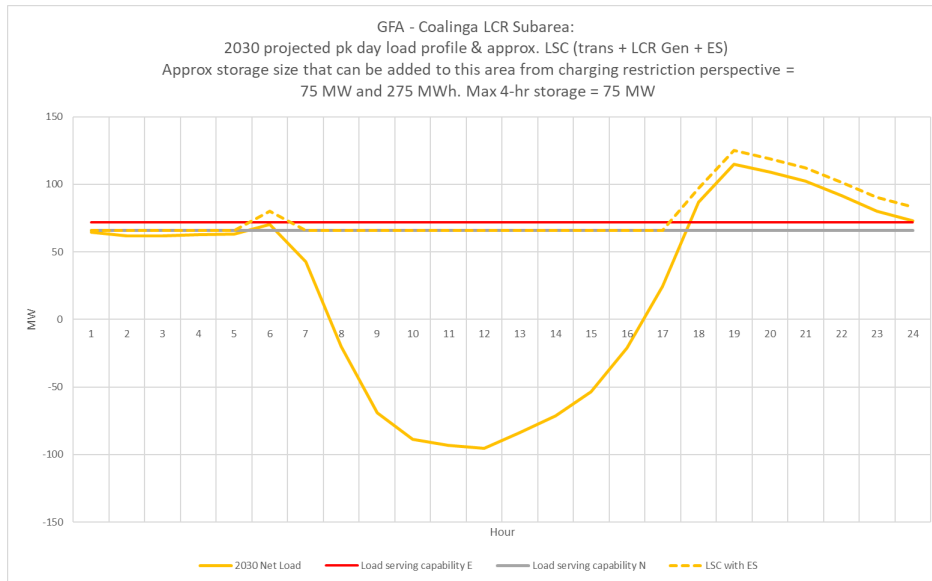
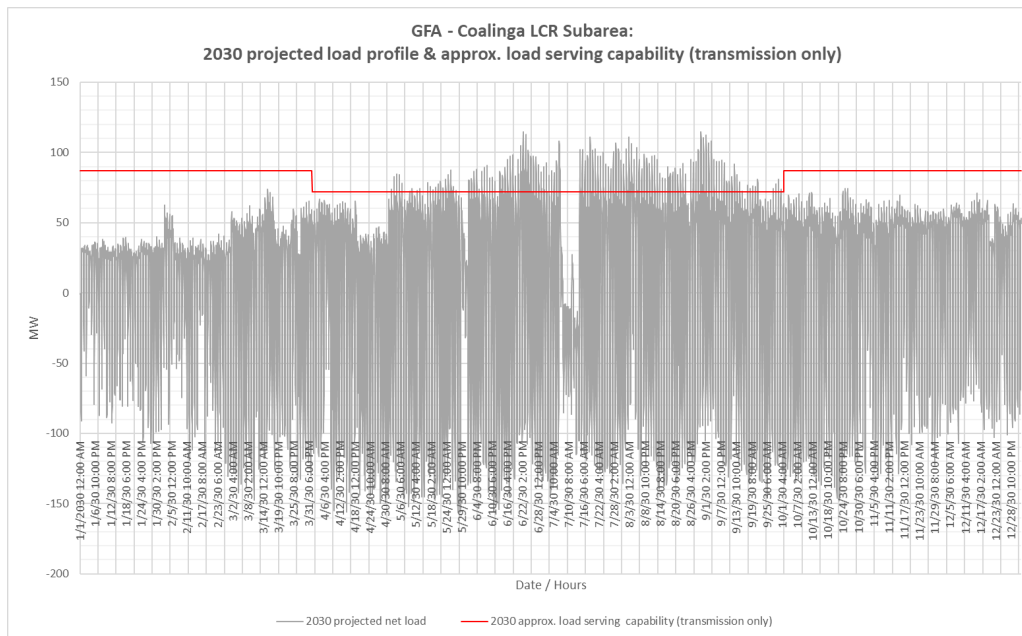

Figure 3.6-40 Coalinga LCR Sub-area 2030 Forecast Hourly Profiles



3.6.6.3.4 Coalinga LCR Sub-area Requirement

Table 3.6-43 identifies the sub-area requirements. The LCR Requirement for a Category P6 contingency is 75 MW including a 64 MW at peak deficiency and 59 MW NQC deficiency.

Table 3.6-43 Coalinga LCR Sub-area Requirements

Year	Limit	Category	Limiting Facility	Contingency	LCR (MW) (Deficiency)
2025	First Limit	P6	Overload on San-Miguel-Coalinga 70kV Line and Voltage Instability	T-1/T-1: Gates 230/70kV TB #5 and Schindler 115/70 kV TB#1	75 (64 at Peak) (59 NQC)

3.6.6.3.5 Effectiveness factors:

All units within the Coalinga Sub-area have the same effectiveness factor.

For most helpful procurement information please read procedure 2210Z Effectiveness Factors under 7430 posted at: <http://www.aiso.com/Documents/2210Z.pdf>

3.6.6.3.6 Alternatives to Reduce or Eliminate Gas Generation

In the 2020-2021 transmission planning process the Coalinga LCR sub-area was not selected to assess alternatives to reduce or eliminate the requirement for gas-fired generation to address the LCR requirement.

As a part of the 2019-2020 transmission planning process the ISO undertook an assessment of the Coalinga sub-area in order to determine potential transmission alternatives to reduce or eliminate the need for gas-fired generation.

3.6.6.4 Borden Sub-area

Borden is a sub-area of the Fresno LCR area.

Borden Sub-area will be eliminated due to the Borden transformer capacity increase transmission project.

3.6.6.5 Reedley Sub-area

Reedley is a sub-area of the Fresno LCR area.

3.6.6.5.1 Reedley LCR Sub-area Diagram

Figure 3.5-41 Reedley LCR Sub-area

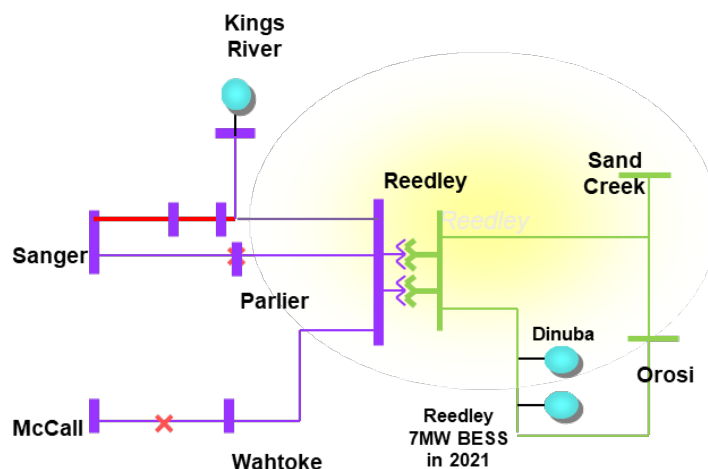

3.6.6.5.2 Reedley LCR Sub-area Load and Resources

Table 3.6-44 provides the forecast load and resources in Reedley LCR sub-area in 2030. The list of generators within the LCR sub-area are provided in Attachment A.

Table 3.6-44 Reedley LCR Sub-area 2030 Forecast Load and Resources

Load (MW)		Generation (MW)		Aug NQC	At Peak
Gross Load	239	Market		51	51
AAEE	-5	MUNI		0	0
Behind the meter DG	0	QF		0	0
Net Load	233	LTPP Preferred Resources		0	0
Transmission Losses	39	Existing 20-minute Demand Response		0	0
Pumps	0	Mothballed		0	0
Load + Losses + Pumps	272	Total		51	51

3.6.6.5.3 Reedley LCR Sub-area Hourly Profiles

Figure 3.6-42 illustrates the forecast 2030 profile for the peak day for the Reedley LCR sub-area with the Category P6 normal and emergency load serving capabilities without local capacity resources. The chart also includes an estimated amount of energy storage that can be added to this local area from charging restriction perspective and the amount of 4-hour storage that can be added to replace local capacity on a 1 MW for 1 MW basis. Figure 3.6-43 illustrates the forecast 2030 hourly profile for Reedley LCR sub-area with the Category P6 emergency load serving capability without local capacity resources.

Figure 3.6-42 Reedley LCR Sub-area 2030 Peak Day Forecast Profiles

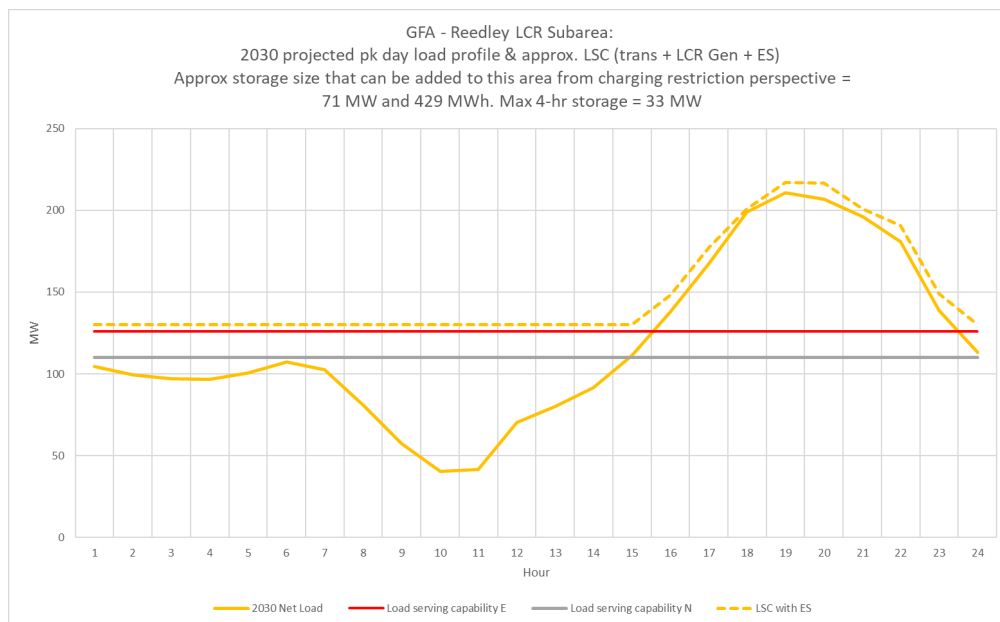
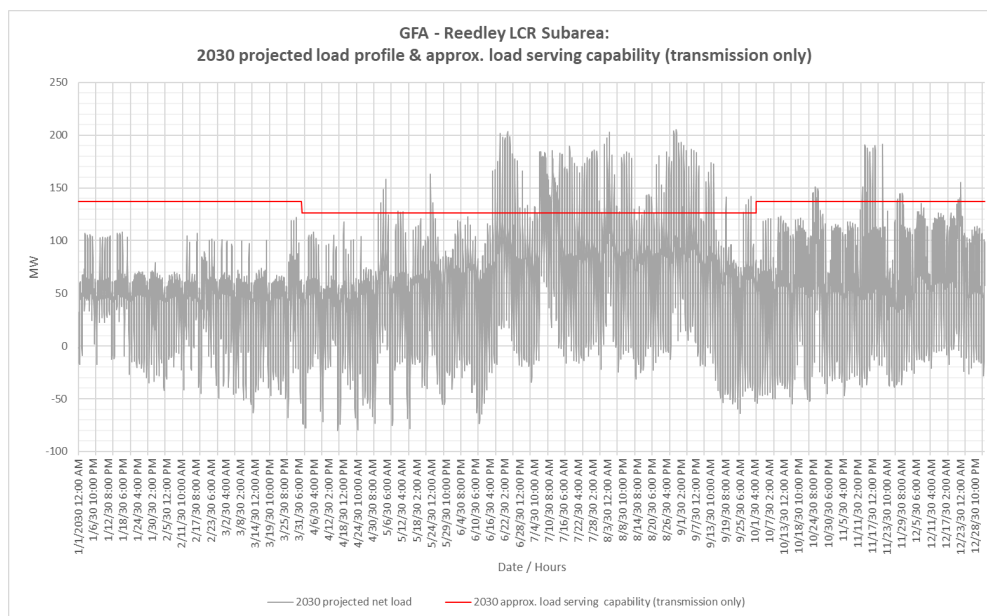

Figure 3.6-43 Reedley LCR Sub-area 2030 Forecast Hourly Profiles



3.6.6.5.4 Reedley LCR Sub-area Requirement

Table 3.6-45 identifies the sub-area requirements. The LCR Requirement for a Category P6 contingency is 120 MW including a 69 MW of deficiency.

Table 3.6-45 Reedley LCR Sub-area Requirements

Year	Limit	Category	Limiting Facility	Contingency	LCR (MW) (Deficiency)

2030	First Limit	P6	Kings River-Sanger-Reedley 115 kV line with Wahtoke load online	McCall-Reedley 115 kV & Sanger-Reedley 115 kV	120 (69)
------	-------------	----	---	---	----------

3.6.6.5.5 Effectiveness factors:

All units within the Reedley Sub-area have the same effectiveness factor.

For most helpful procurement information please read procedure 2210Z Effectiveness Factors under 7430 posted at: <http://www.caiso.com/Documents/2210Z.pdf>

3.6.6.5.6 Alternatives to Reduce or Eliminate Gas Generation

In the 2020-2021 transmission planning process the Reedley LCR sub-area was not selected to assess alternatives to reduce or eliminate the requirement for gas-fired generation to address the LCR requirement.

As a part of the 2018-2019 and the 2019-2020 transmission planning process the ISO undertook an assessment of the Reedley sub-area in order to determine potential transmission alternatives to reduce or eliminate the need for gas-fired generation. The 2028 LCT study identified that the requirement in the Reedley Sub-area can be addressed with non-gas generation.

3.6.6.1 Panoche Sub-area

Panoche is a sub-area of the Fresno LCR area.

3.6.6.1.1 Panoche LCR Sub-area Diagram

Figure 3.6-44 Panoche LCR Sub-area

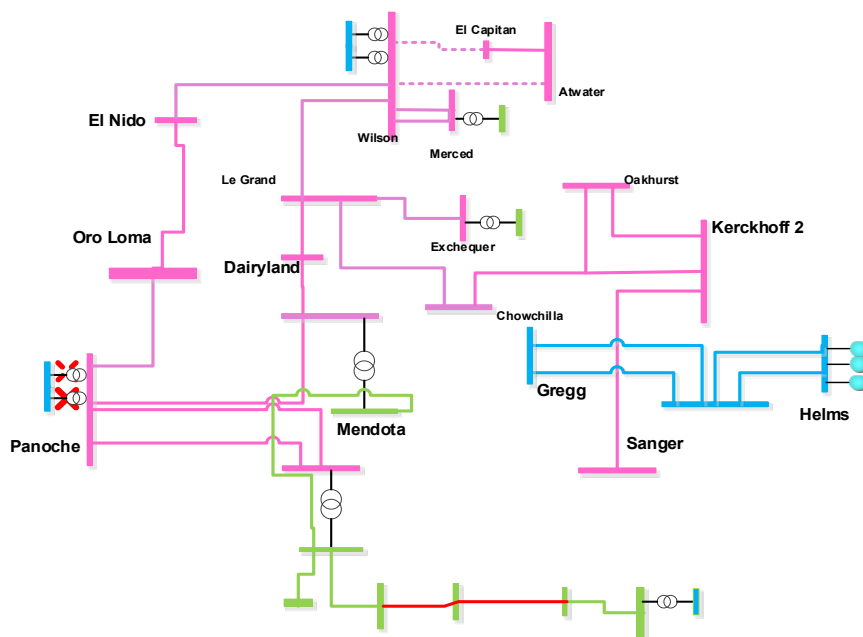

3.6.6.1.2 Panoche LCR Sub-area Load and Resources

Table 3.6-46 provides the forecast load and resources in Panoche LCR sub-area in 2030. The list of generators within the LCR sub-area are provided in Attachment A.

Table 3.6-46 Panoche LCR Sub-area 2030 Forecast Load and Resources

Load (MW)		Generation (MW)	Aug NQC	At Peak
Gross Load	486	Market, Net Seller	282	282
AAEE	-9	MUNI	100	100
Behind the meter DG	-1	QF	3	3
Net Load	477	Solar	89	40
Transmission Losses	16	Existing 20-minute Demand Response	0	0
Pumps	0	Mothballed	0	0
Load + Losses + Pumps	493	Total	474	425

3.6.6.1.3 Panoche LCR Sub-area Hourly Profiles

Figure 3.6-45 illustrates the forecast 2030 profile for the peak day for the Panoche LCR sub-area with the Category P6 normal and emergency load serving capabilities without local capacity resources. The chart also includes an estimated amount of energy storage that can be added to this local area from charging restriction perspective and the amount of 4-hour storage that can be

added to replace local capacity on a 1 MW for 1 MW basis. Figure 3.6-46 illustrates the forecast 2030 hourly profile for Panoche LCR sub-area with the Category P6 emergency load serving capability without local capacity resources.

Figure 3.6-45 Panoche LCR Sub-area 2030 Peak Day Forecast Profiles

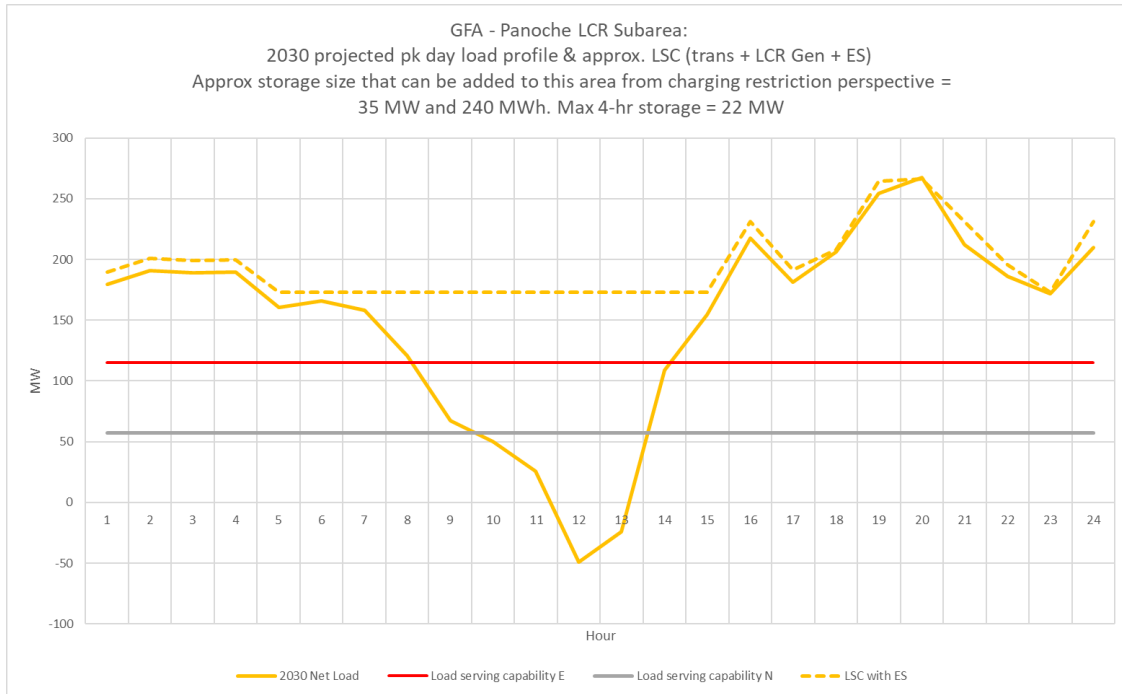
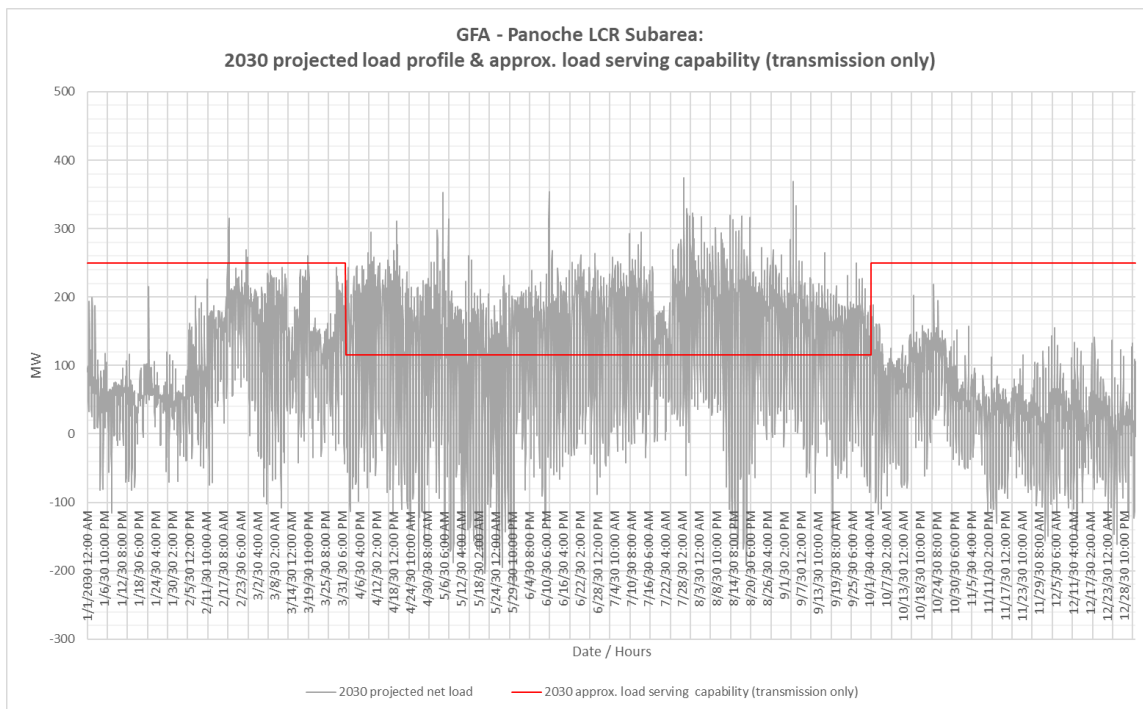

Figure 3.6-46 Panoche LCR Sub-area 2030 Forecast Hourly Profiles



3.6.6.1.4 Panoche LCR Sub-area Requirement

Table 3.6-47 identifies the sub-area LCR requirements. The LCR Requirement for a Category P6 contingency is 275 MW.

Table 3.6-47 Panoche LCR Sub-area Requirements

Year	Limit	Category	Limiting Facility	Contingency	LCR (MW) (Deficiency)
2030	First limit	P6	Five Points-Huron-Gates 70 kV line	Panoche 230/115 kV TB #2 and Panoche 230/115 kV TB #	275

3.6.6.1.5 Effectiveness factors:

Effective factors for generators in the Panoche LCR sub-area are in Attachment B table title [Panoche](#).

For other helpful procurement information please read procedure 2210Z Effectiveness Factors under 7430 posted at: <http://www.caiso.com/Documents/2210Z.pdf>

3.6.6.2 Wilson 115 kV Sub-area

Wilson 115 kV sub-area will be eliminated due to the Wilson #3 230/115 kV transformer coming into service as part of the Wilson 115 kV area reinforcement transmission project.

3.6.6.3 Herndon Sub-area

Herndon is a sub-area of the Fresno LCR area.

3.6.6.3.1 Herndon LCR Sub-area Diagram

Figure 3.6-47 Herndon LCR Sub-area

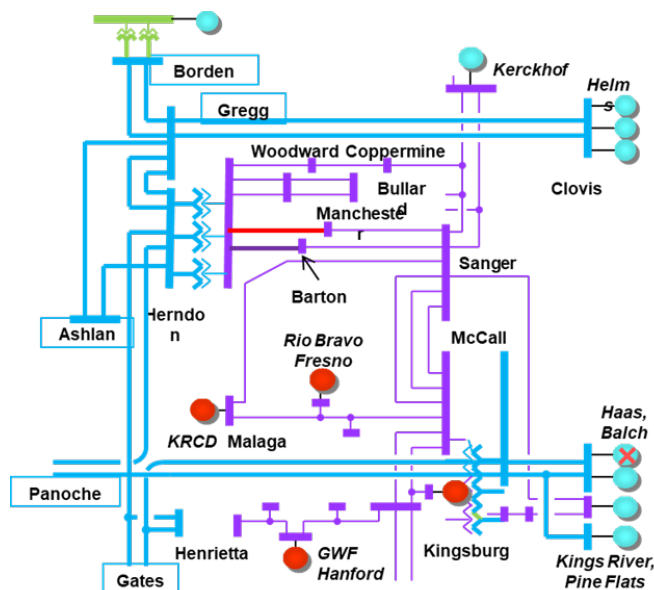

3.6.6.3.2 Herndon LCR Sub-area Load and Resources

Table 3.6-48 provides the forecast load and resources in Herndon LCR sub-area in 2030. The list of generators within the LCR sub-area are provided in Attachment A.

Table 3.6-48 Herndon LCR Sub-area 2030 Forecast Load and Resources

Load (MW)		Generation (MW)	Aug NQC	At Peak
Gross Load	1680	Market, Net Seller, Battery	997	997
AAEE	-35	MUNI	98	98
Behind the meter DG	0	QF	1	1
Net Load	1644	Solar	63	28
Transmission Losses	33	Existing 20-minute Demand Response	0	0
Pumps	0	Mothballed	0	0
Load + Losses + Pumps	1677	Total	1159	1124

3.6.6.3.3 Herndon LCR Sub-area Hourly Profiles

Figure 3.6-48 illustrates the forecast 2030 profile for the peak day for the Herndon LCR sub-area with the Category P6 normal and emergency load serving capabilities without local capacity resources. The chart also includes an estimated amount of energy storage that can be added to this local area from charging restriction perspective and the amount of 4-hour storage that can be added to replace local capacity on a 1 MW for 1 MW basis. Figure 3.6-49 illustrates the forecast 2030 hourly profile for Herndon LCR sub-area with the Category P6 emergency load serving capability without local capacity resources.

Figure 3.6-48 Herndon LCR Sub-area 2030 Peak Day Forecast Profiles

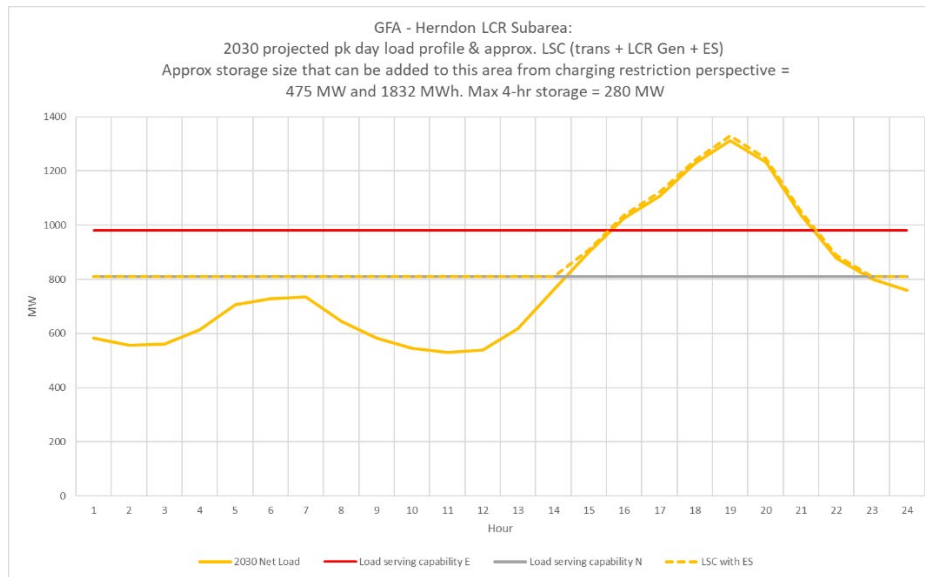
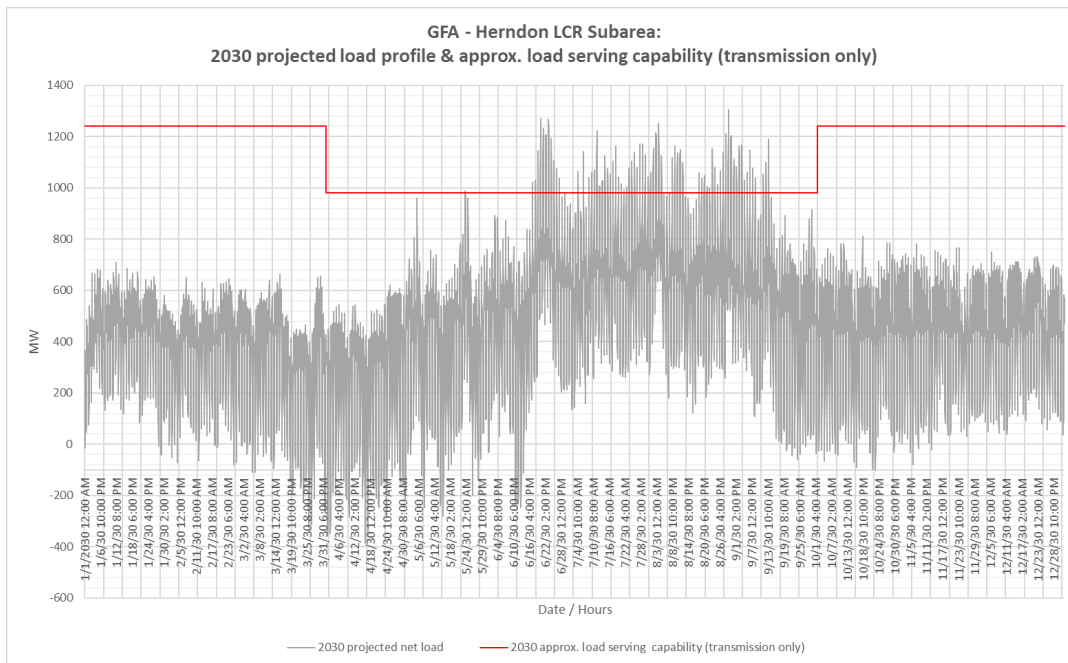

Figure 3.6-49 Herndon LCR Sub-area 2030 Forecast Hourly Profiles



3.6.6.3.4 Herndon LCR Sub-area Requirement

Table 3.6-49 identifies the sub-area LCR requirements. The LCR Requirement for a Category P6 contingency is 476 MW.

Table 3.6-49 Herndon LCR Sub-area Requirements

Year	Limit	Category	Limiting Facility	Contingency	LCR (MW) (Deficiency)
2030	First limit	P6	Herndon-Manchester 115 kV	Herndon-Woodward 115 kV line & Herndon-Barton 115 kV line	476

3.6.6.3.5 Effectiveness factors:

Effectiveness factors for generators in the Herndon LCR sub-area are in Attachment B table titled [Herndon](#).

For other helpful procurement information please read procedure 2210Z Effectiveness Factors under 7430 posted at: <http://www.aiso.com/Documents/2210Z.pdf>

3.6.6.3.6 Alternatives to Reduce or Eliminate Gas Generation

In the 2020-2021 transmission planning process the Herndon LCR sub-area was not selected to assess alternatives to reduce or eliminate the requirement for gas-fired generation to address the LCR requirement.

As a part of the 2018-2019 transmission planning process the ISO undertook an assessment of the Herndon sub-area in order to determine potential transmission alternatives to reduce or eliminate the need for gas-fired generation. The 2028 LCR assessment indicates that the Herndon LCR sub-area requirement can be addressed by non-gas generation in the sub-area.

3.6.6.4 Fresno Area Overall

3.6.6.4.1 Fresno Overall Area Diagram

Figure 3.6-50 Fresno Overall LCR Area

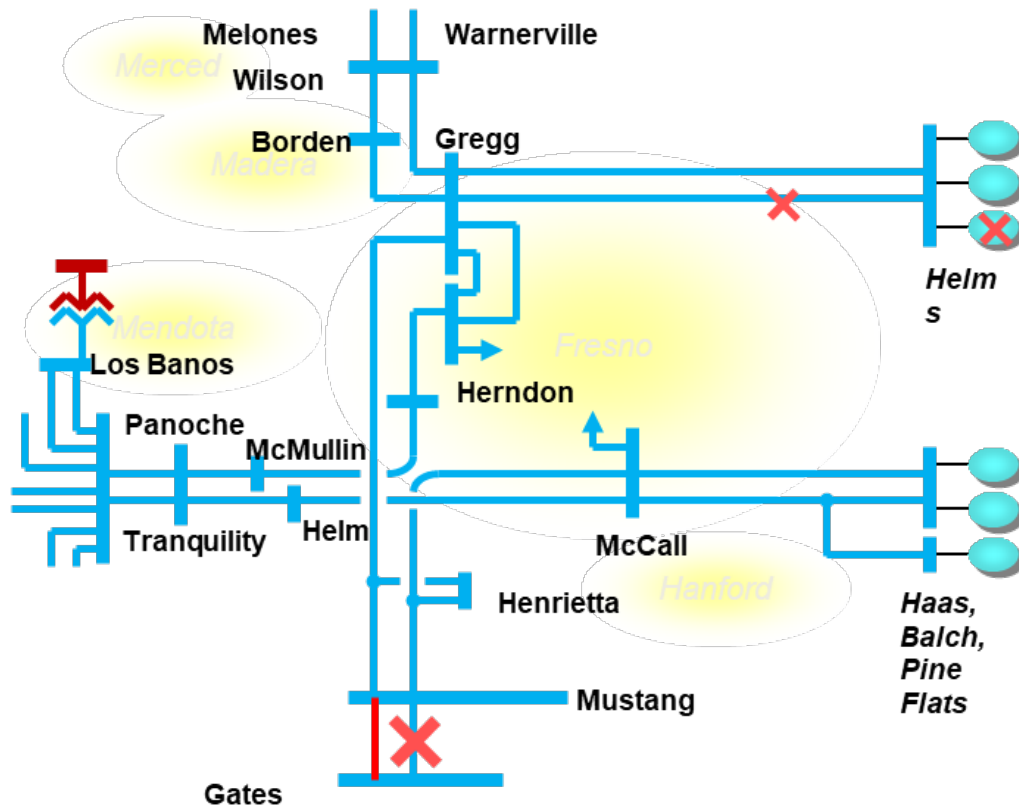

3.6.6.4.2 Fresno Overall LCR Area Load and Resources

Table 3.6-39 provides the forecast load and resources in Fresno LCR area in 2030. The list of generators within the LCR area are provided in Attachment A.

3.6.6.4.3 Fresno Overall LCR Area Hourly Profiles

Figure 3.6-51 illustrates the forecast 2030 profile for the peak day for the overall LCR area with the Category P6 normal and emergency load serving capabilities without local capacity resources. The chart also includes an estimated amount of energy storage that can be added to this local area from charging restriction perspective and the amount of 4-hour storage that can be added to replace local capacity on a 1 MW for 1 MW basis. Figure 3.6-52 illustrates the forecast 2030 hourly profile for overall LCR area with the Category P6 emergency load serving capability without local capacity resources.

Figure 3.6-51 Greater Fresno Overall LCR Area 2030 Peak Day Forecast Profiles

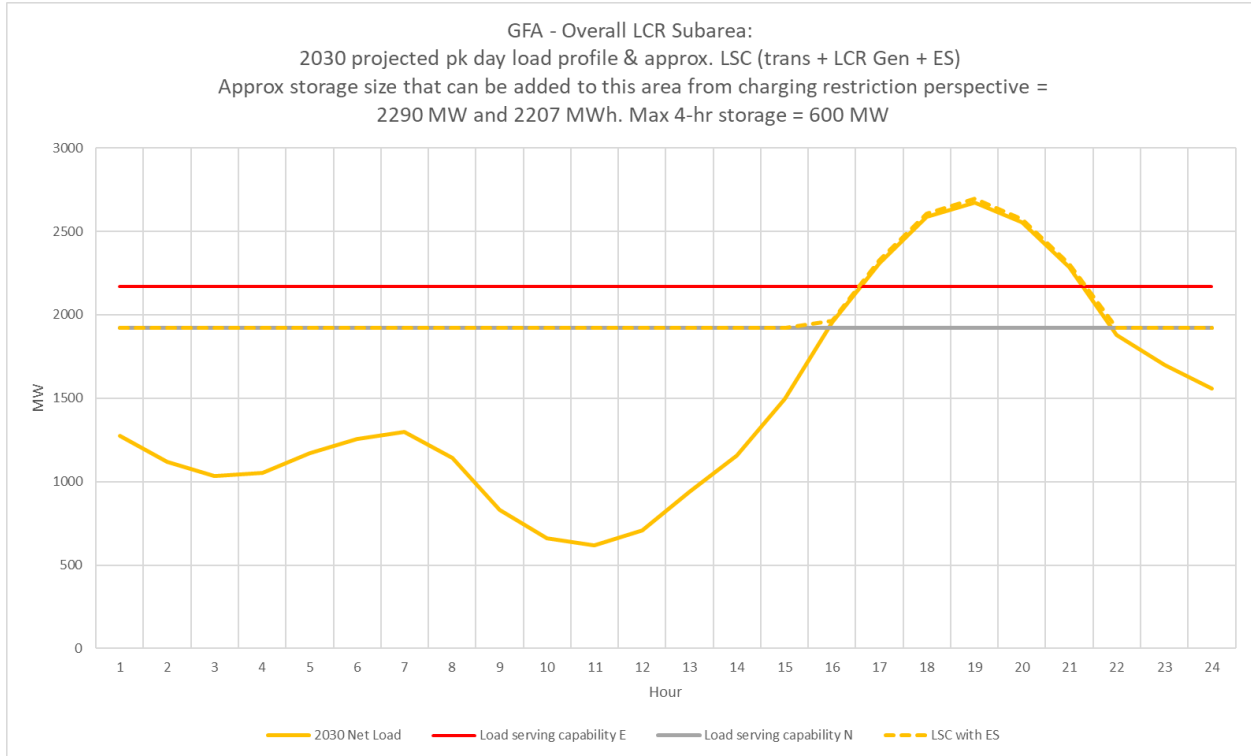
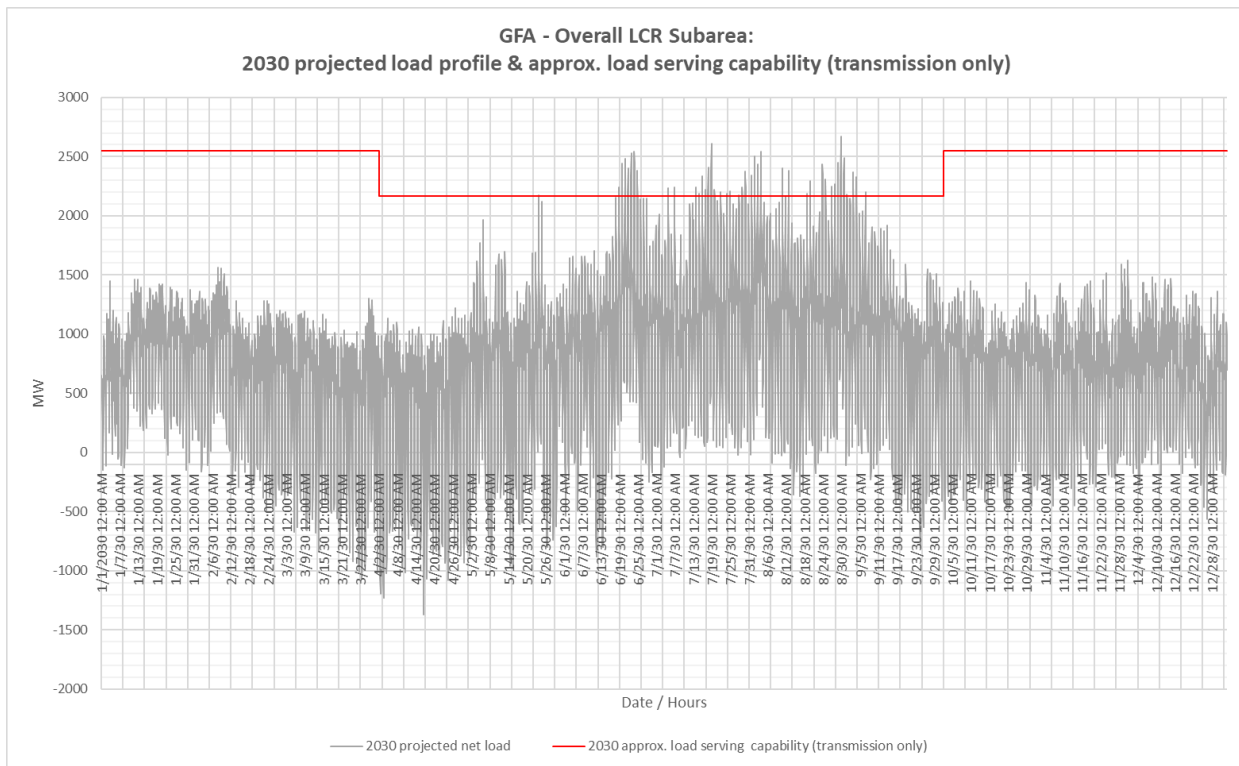

Figure 3.6-52 Greater Fresno Overall LCR Area 2030 Forecast Hourly Profiles



3.6.6.4.4 Fresno Overall LCR Sub-area Requirement

Table 3.6-50 identifies the area LCR requirements. The LCR requirement Category P6 contingency is 2296 MW.

Table 3.6-50 Fresno Overall LCR Area Requirements

Year	Limit	Category	Limiting Facility	Contingency	LCR (MW) (Deficiency)
2030	First limit	P6	GWF-Contandida 115 kV Line	Panoche-Helm 230 kV Line and Gates-McCall 230 kV line	2296

3.6.6.4.5 Effectiveness factors:

For most helpful procurement information please read procedure 2210Z Effectiveness Factors under 7430 posted at: <http://www.aiso.com/Documents/2210Z.pdf>

3.6.6.4.6 Changes compared to the 2025 LCT study

The load forecast increased by 310 MW and the LCR has increased by 325 MW, due to load increase.

3.6.6.4.7 Alternatives to Reduce or Eliminate Gas Generation

In the 2020-2021 transmission planning process the Fresno overall area was not selected to assess alternatives to reduce or eliminate the requirement for gas-fired generation to address the LCR requirement.

As a part of the 2018-2019 transmission planning process the ISO undertook an assessment of the Wilson sub-area (Fresno overall area) in order to determine potential transmission alternatives to reduce or eliminate the need for gas-fired generation. The 2028 LCT study identified that the requirement in the Wilson Sub-area (Fresno overall area) can be addressed with non-gas generation.

3.6.7 Kern Area

3.6.7.1 *Area Definition:*

The transmission facilities coming into the Kern PP sub-area are:

- Midway-Kern PP #1 230 kV Line
- Midway-Kern PP #2 230 kV Line
- Midway-Kern PP #3 230 kV Line
- Midway-Kern PP #4 230 kV Line
- Wind Gap-Wheeler Ridge #1 230 kV Line
- Wind Gap-Wheeler Ridge #2 230 kV Line
- Famoso-Lerdo 115 kV Line (Normal Open)
- Wasco-Famoso 70 kV Line (Normal Open)
- Copus-Old River 70 kV Line (Normal Open)
- Copus-Old River 70 kV Line (Normal Open)
- Weedpatch CB 32 70 kV (Normal Open)

The substations that delineate the Kern-PP sub-area are:

- Midway 230 kV is out and Bakersfield 230 kV is in
- Midway 230 kV is out Kern PP 230 kV is in
- Midway 230 kV is out and Stockdale 230 kV is in
- Midway 230 kV is out Kern PP 230 kV is in
- Wind Gap 230 kV is out Wheeler Ridge 230 kV is in
- Wind Gap 230 kV is out Wheeler Ridge 230 kV is in
- Famoso 115 kV is out Cawelo 115 kV is in
- Wasco 70 kV is out Mc Farland 70 kV is in
- Copus 70 kV is out, South Kern Solar 70 kV is in
- Lakeview 70 kV is out, San Emidio Junction 70 kV is in
- Weedpatch 70 kV is out, Wellfield 70 kV is in

3.6.7.1.1 Kern LCR Area Diagram

Figure 3.6-53 Kern LCR Area

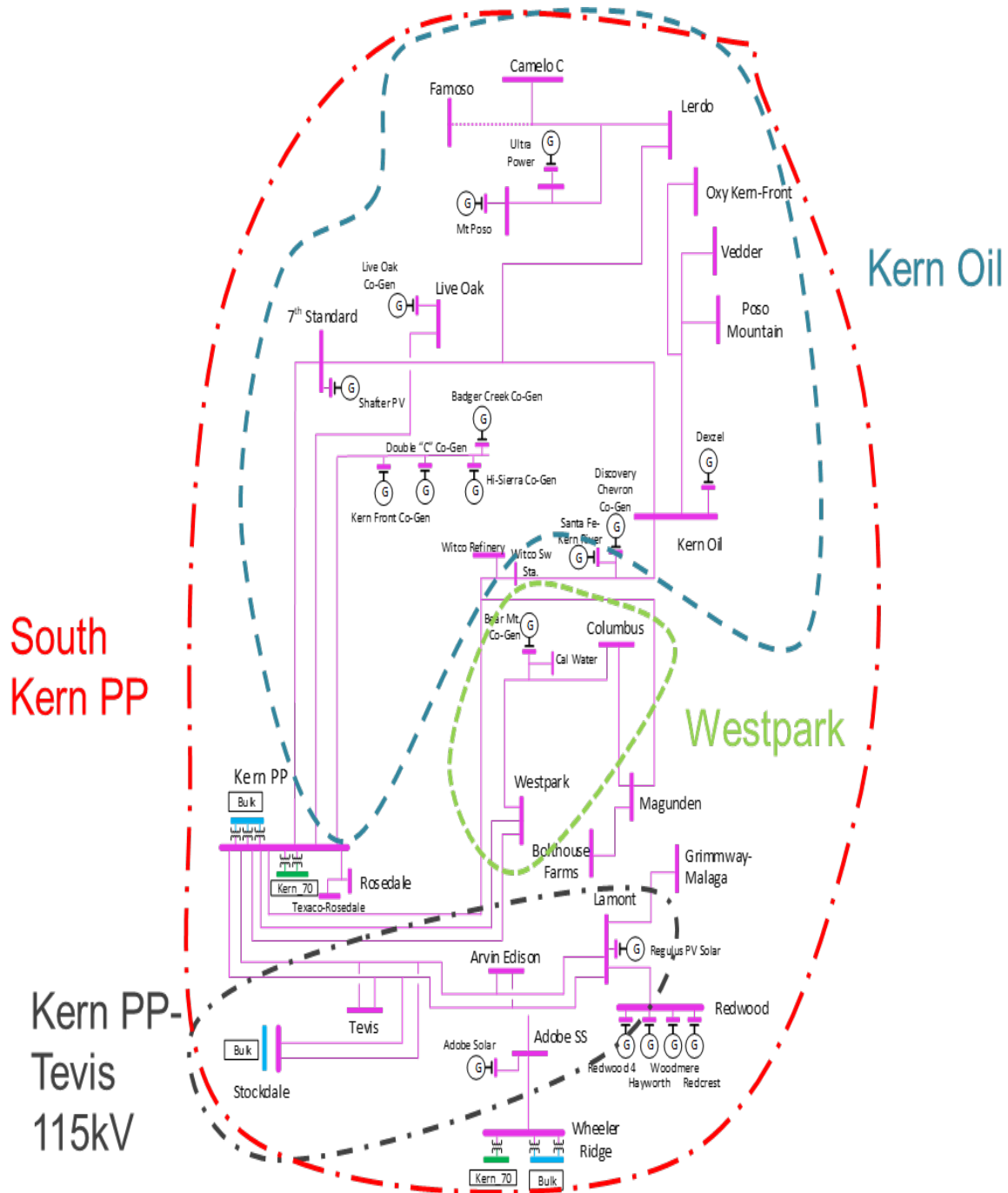

3.6.7.1.2 Kern LCR Area Load and Resources

Table 3.6-57 provides the forecast load and resources in Kern LCR area in 2030. The list of generators within the LCR area are provided in Attachment A.

In year 2030 the estimated time of local area peak is 19:20 PM.

At the local area peak time the estimated, ISO metered, solar output is 0.00%.

If required, all non-solar technology type resources are dispatched at NQC.

Table 3.6-51 Kern LCR Area 2030 Forecast Load and Resources

Load (MW)		Generation (MW)	Aug NQC	At Peak
Gross Load	1125	Market, Net Seller	330	330
AAEE	-26	MUNI	0	0
Behind the meter DG	0	QF	5	5
Net Load	1099	Solar	78	0
Transmission Losses	11	Existing 20-minute Demand Response	0	0
Pumps	0	Mothballed	0	0
Load + Losses + Pumps	1110	Total	413	335

3.6.7.1.3 Approved transmission projects modeled

Kern PP 230 kV area reinforcement project

Midway-Kern PP 1, 3 & 4 230 kV line capacity increase project

Kern PP 115 kV area reinforcement project

3.6.7.2 Kern PP 70 kV Sub-area

Kern PP 70 kV is a sub-area of the Kern LCR area.

The Kern PP 70 kV Sub-area has been eliminated due to load changes and project modeling changes in the area.

3.6.7.3 Westpark Sub-area

Westpark is a sub-area of the Kern LCR area.

3.6.7.3.1 Westpark LCR Sub-area Diagram

Please see Figure 3.6-53 for Westpark sub-area diagram.

3.6.7.3.2 Westpark LCR Sub-area Load and Resources

Table 3.6-58 provides the forecast load and resources in Westpark LCR sub-area in 2030. The list of generators within the LCR sub-area are provided in Attachment A.

Table 3.6-52 Westpark LCR Sub-area 2030 Forecast Load and Resources

Load (MW)		Generation (MW)	Aug NQC	At Peak
Gross Load	443	Market, Net Seller	139	139
AAEE	-10	MUNI	0	0
Behind the meter DG	0	QF	5	5
Net Load	433	Solar	7	0
Transmission Losses	1	Existing 20-minute Demand Response	0	0
Pumps	0	Mothballed	0	0
Load + Losses + Pumps	434	Total	151	144

3.6.7.3.3 Westpark LCR Sub-area Hourly Profiles

Figure 3.6-54 illustrates the forecast 2030 profile for the peak day for the Westpark LCR sub-area with the Category P6 normal and emergency load serving capabilities without local capacity resources. The chart also includes an estimated amount of energy storage that can be added to this local area from charging restriction perspective and the amount of 4-hour storage that can be added to replace local capacity on a 1 MW for 1 MW basis. Figure 3.6-55 illustrates the forecast 2030 hourly profile for Westpark LCR sub-area with the Category P6 contingency transmission capability without local capacity resources.

Figure 3.6-54 Westpark LCR Sub-area 2030 Peak Day Forecast Profiles

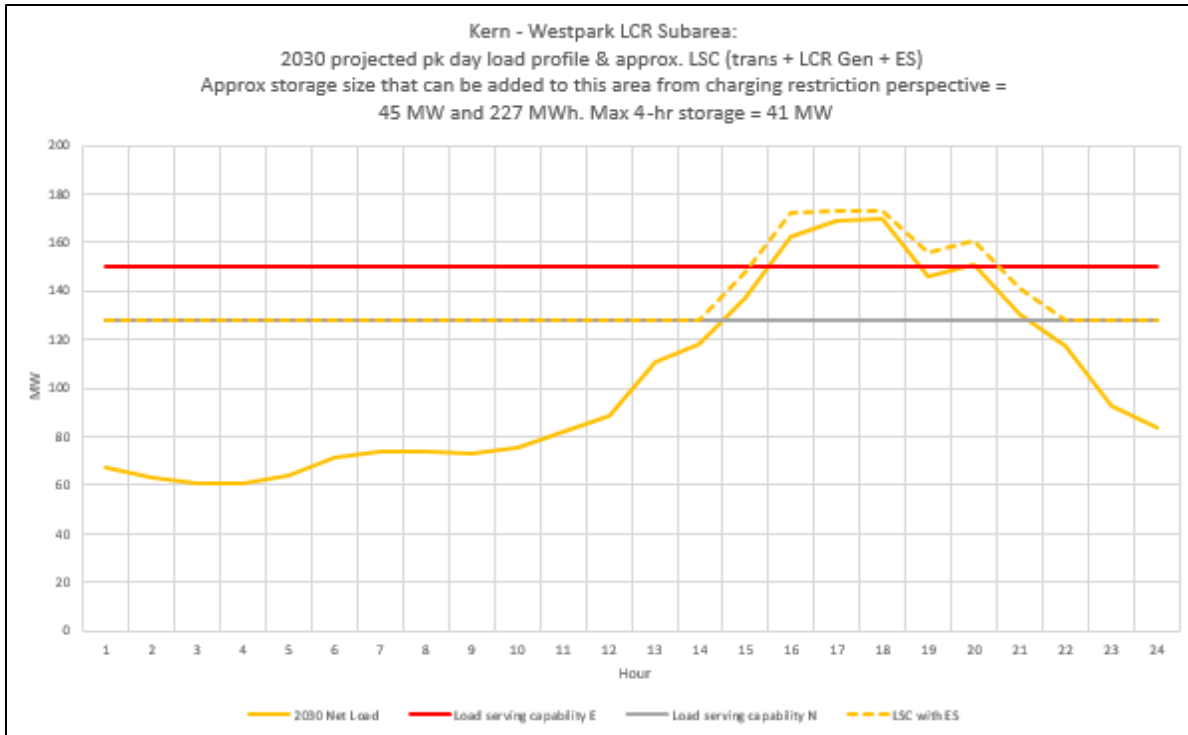
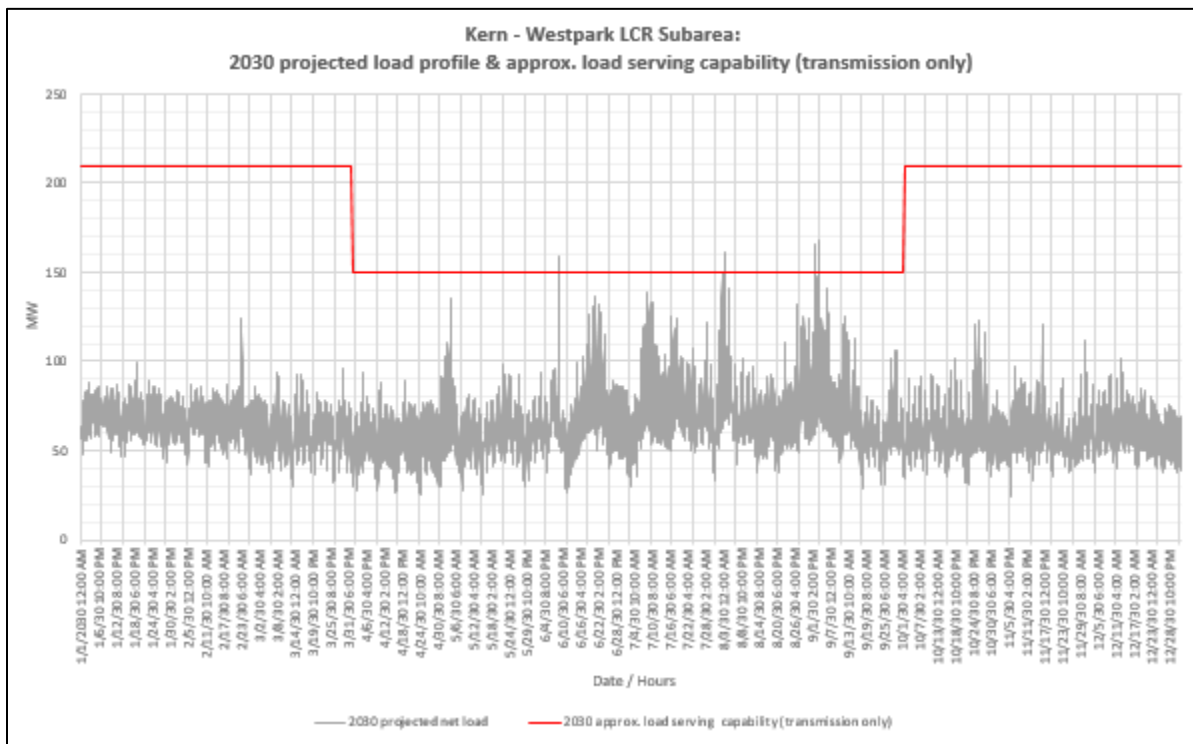

Figure 3.6-55 Westpark LCR Sub-area 2030 Forecast Hourly Profiles



3.6.7.3.4 Westpark LCR Sub-area Requirement

Table 3.6-59 identifies the sub-area LCR requirements. The LCR requirement for Category P3 contingency is 150 MW with a 6 MW deficiency at peak.

Table 3.6-53 Westpark LCR Sub-area Requirements

Year	Limit	Category	Limiting Facility	Contingency	LCR (MW) (Deficiency)
2030	First Limit	P3	Kern-West Park #2 115 kV	Kern-West Park #1 115 kV and PSE-Bear Generation	150 (6 Peak)

3.6.7.3.5 Effectiveness factors:

All units within the Westpark Sub-area have the same effectiveness factor.

For most helpful procurement information please read procedure 2210Z Effectiveness Factors under 7450 posted at: <http://www.aiso.com/Documents/2210Z.pdf>

3.6.7.3.6 Alternatives to Reduce or Eliminate Gas Generation

In the 2020-2021 transmission planning process the Westpark LCR sub-area was not selected to assess alternatives to reduce or eliminate the requirement for gas-fired generation to address the LCR requirement.

As a part of the 2018-2019 transmission planning process the ISO undertook an assessment of the Westpark sub-area in order to determine potential transmission alternatives to reduce or eliminate the need for gas-fired generation.

3.6.7.4 Kern Oil Sub-area

Kern Oil is a sub-area of the Kern LCR area.

3.6.7.4.1 Kern Oil LCR Sub-area Diagram

Figure 3.6-56 Kern Oil LCR Sub-area

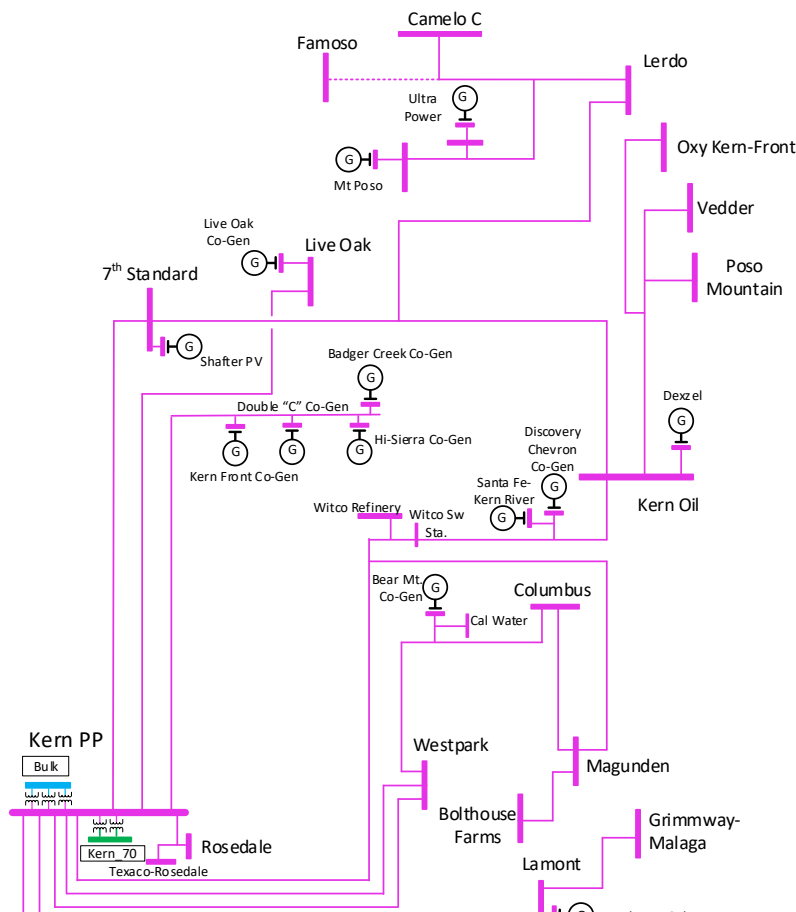

3.6.7.4.2 Kern Oil LCR Sub-area Load and Resources

Table 3.6-60 provides the forecast load and resources in Kern Oil LCR sub-area in 2030. The list of generators within the LCR sub-area are provided in Attachment A.

Table 3.6-54 Kern Oil LCR Sub-area 2030 Forecast Load and Resources

Load (MW)		Generation (MW)	Aug NQC	At Peak
Gross Load	632	Market	95	95
AAEE	-12	MUNI	0	0
Behind the meter DG	0	QF	5	5
Net Load	620	Solar	7	0

Transmission Losses	1	Existing 20-minute Demand Response	0	0
Pumps	0	Mothballed	0	0
Load + Losses + Pumps	619	Total	107	100

3.6.7.4.3 Kern Oil LCR Sub-area Hourly Profiles

Figure 3.6-57 illustrates the forecast 2030 profile for the peak day for the Kern Oil LCR sub-area with the Category P6 normal and emergency load serving capabilities without local capacity resources. The chart also includes an estimated amount of energy storage that can be added to this local area from charging restriction perspective and the amount of 4-hour storage that can be added to replace local capacity on a 1 MW for 1 MWh basis. Figure 3.6-58 illustrates the forecast 2030 hourly profile for Kern Oil LCR sub-area with the Category P6 contingency transmission capability without local capacity resources.

Figure 3.6-57 Kern Oil LCR Sub-area 2030 Peak Day Forecast Profiles

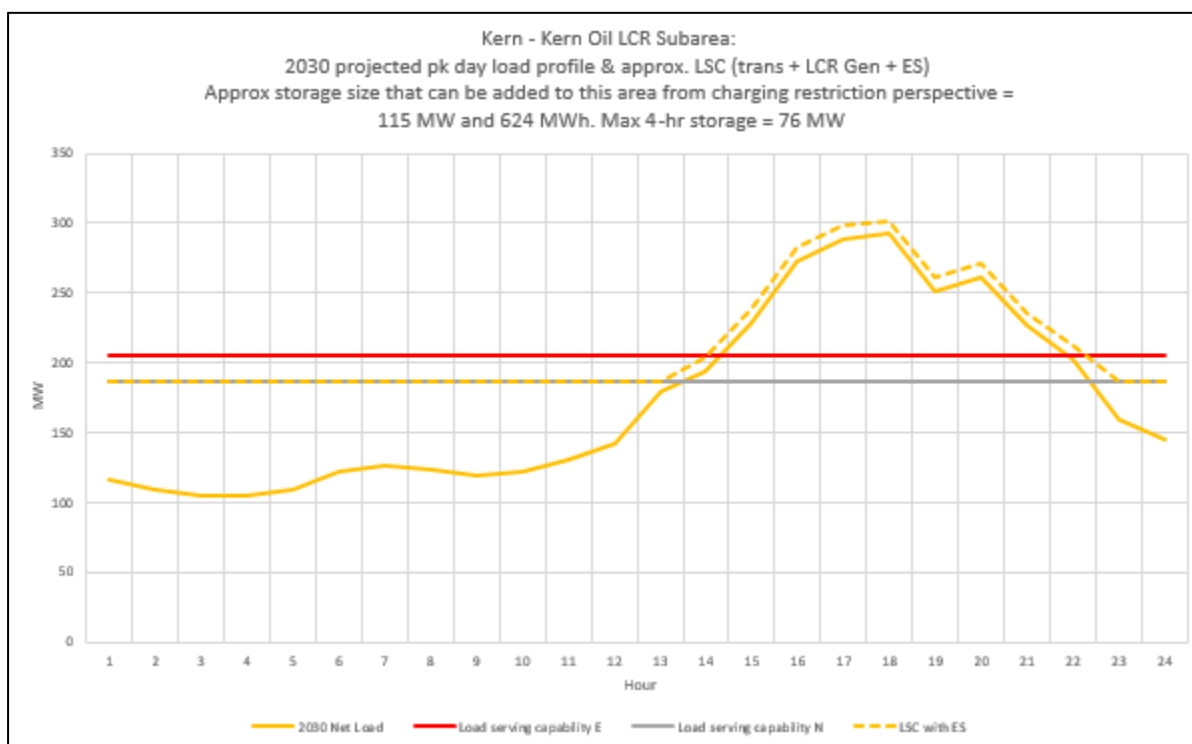
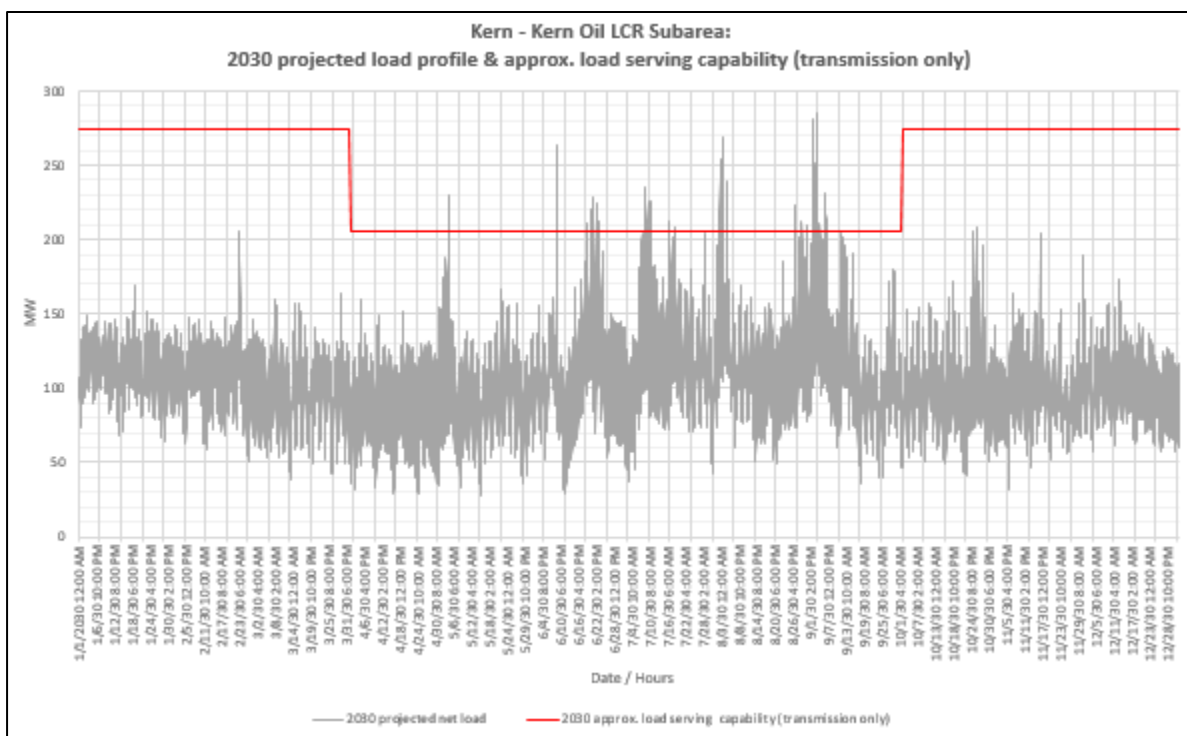

Figure 3.6-58 Kern Oil LCR Sub-area 2030 Forecast Hourly Profiles



3.6.7.4.4 Kern Oil LCR Sub-area Requirement

Table 3.6-61 identifies the sub-area LCR requirements. The LCR requirement for Category Category P6 contingency LCR requirement is 115 MW with a 8 MW NQC deficiency (15 MW peak deficiency).

Table 3.6-55 Kern Oil LCR Sub-area Requirements

Year	Limit	Category	Limiting Facility	Contingency-	LCR (MW) (Deficiency)
2030	First Limit	P6	Kern Power to Kern Water 115 kV line section	Kern PP-7th Standard 115 kV lines & Kern PP-Live Oak 115 kV Line	115 (8 NQC/15 Peak)

3.6.7.4.5 Effectiveness factors:

All units within the Kern Oil Sub-area have the same effectiveness factor.

For most helpful procurement information please read procedure 2210Z Effectiveness Factors under 7450 posted at: <http://www.caiso.com/Documents/2210Z.pdf>

3.6.7.4.6 Alternatives to Reduce or Eliminate Gas Generation

In the 2020-2021 transmission planning process the Kern Oil LCR sub-area was not selected to assess alternatives to reduce or eliminate the requirement for gas-fired generation to address the LCR requirement.

As a part of the 2018-2019 transmission planning process the ISO undertook an assessment of the Kern Oil sub-area in order to determine potential transmission alternatives to reduce or eliminate the need for gas-fired generation.

3.6.7.5 Kern PP-Tevis 115 kV Sub-area

Kern PP-Tevis 115 kV is a sub-area of the Kern LCR area.

3.6.7.5.1 Kern PP-Tevis 115 kV LCR Sub-area Diagram

Figure 3.6-59 Kern PP-Tevis 115 kV LCR Sub-area

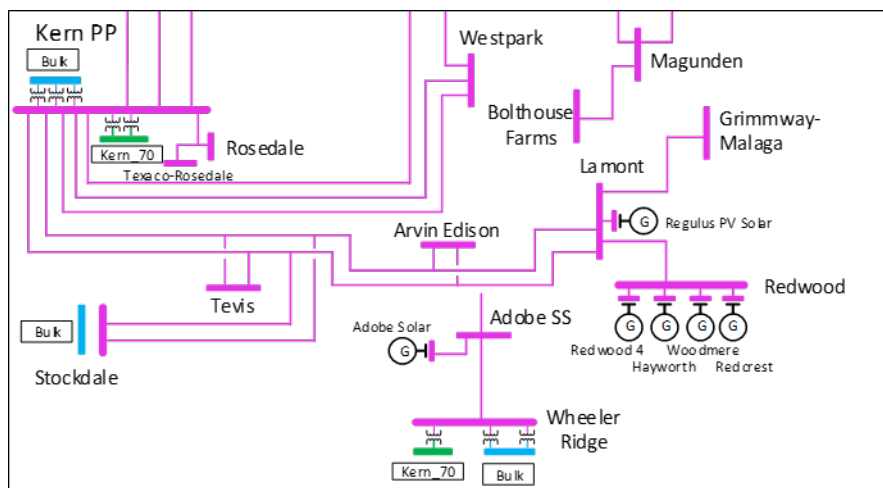

3.6.7.5.2 Kern PP-Tevis 115 kV LCR Sub-area Load and Resources

Table 3.6-56 provides the forecast load and resources in Kern PP-Tevis LCR sub-area in 2030. The list of generators within the LCR sub-area are provided in Attachment A.

Table 3.6-56 Kern PP-Tevis LCR Sub-area 2030 Forecast Load and Resources

Load (MW)		Generation (MW)	Aug NQC	At Peak
Gross Load	189	Market	0	0
AAEE	-4	MUNI	0	0
Behind the meter DG	0	QF	0	0
Net Load	185	Solar	52	0
Transmission Losses	0	Existing 20-minute Demand Response	0	0
Pumps	0	Mothballed	0	0
Load + Losses + Pumps	185	Total	52	0

3.6.7.5.3 Kern PP-Tevis 115 kV LCR Sub-area Hourly Profiles

Figure 3.6-60 illustrates the forecast 2030 profile for the peak day for the Kern PP-Tevis LCR sub-area with the Category P6 normal and emergency load serving capabilities without local capacity resources. The chart also includes an estimated amount of energy storage that can be added to this local area from charging restriction perspective and the amount of 4-hour storage that can be added to replace local capacity on a 1 MW for 1 MW basis. Figure 3.6-61 illustrates the forecast 2030 hourly profile for Kern PP-Tevis LCR sub-area with the Category P6 contingency transmission capability without local capacity resources.

Figure 3.6-60 Kern PP-Tevis LCR Sub-area 2030 Peak Day Forecast Profiles

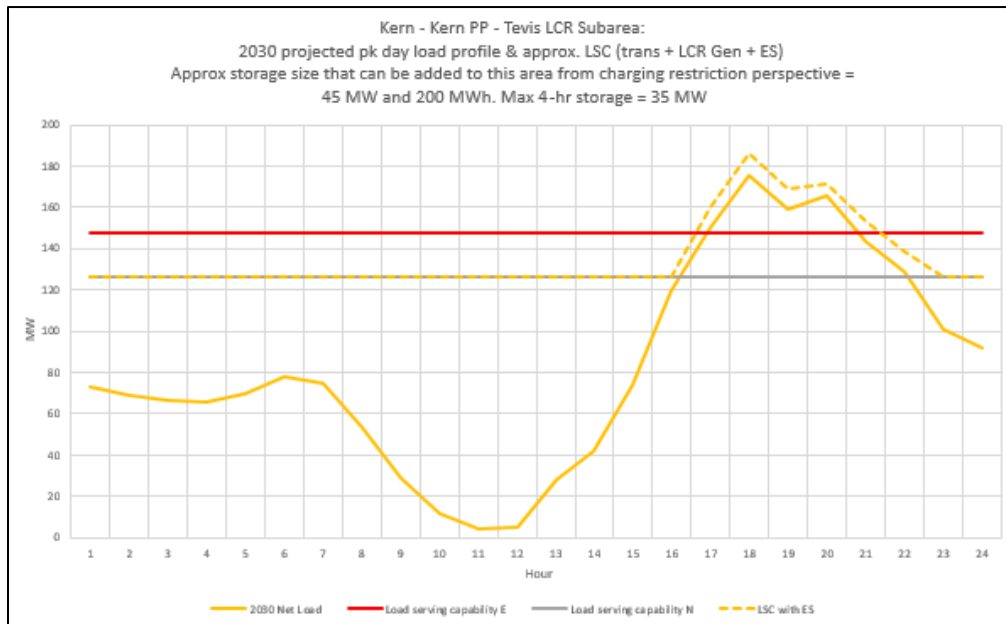
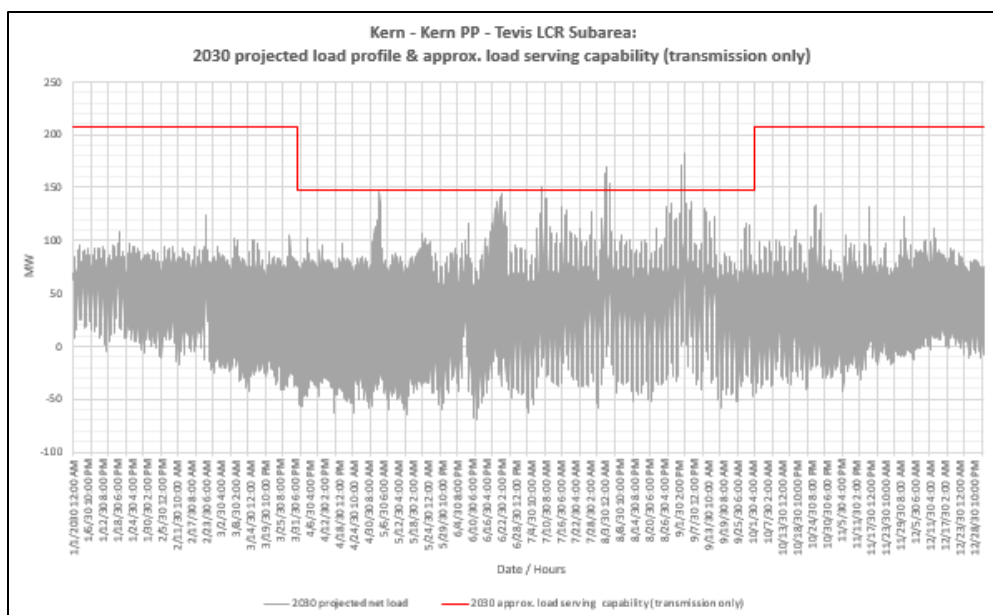

Figure 3.6-61 Kern PP-Tevis LCR Sub-area 2030 Forecast Hourly Profiles



3.6.7.5.4 Kern PP-Tevis 115 kV LCR Sub-area Requirement

Table 3.6-57 identifies the sub-area LCR requirements. The LCR requirement for Category Category P2 contingency LCR requirement is 57 MW including a 57 MW deficiency at peak and 7 MW NQC deficiency.

Table 3.6-57 Kern pp-Tevis LCR Sub-area Requirements

Year	Limit	Category	Limiting Facility	Contingency-	LCR (MW) (Deficiency)
2030	First Limit	P2	Kern Power -TevisJ2 115 kV Line	Kern-Tevis-Stockdale 115 kV (Kern Pwr-Tevis J1 section)	57 (57 Peak, 7 NQC)

3.6.7.5.5 Effectiveness factors:

All units within the Kern PP-Tevis 115 kV Sub-area have the same effectiveness factor.

For most helpful procurement information please read procedure 2210Z Effectiveness Factors under 7450 posted at: <http://www.aiso.com/Documents/2210Z.pdf>

3.6.7.5.6 Alternatives to Reduce or Eliminate Gas Generation

In the 2020-2021 transmission planning process the Kern PP 70 kV LCR sub-area was not selected to assess alternatives to reduce or eliminate the requirement for gas-fired generation to address the LCR requirement.

As a part of the 2018-2019 transmission planning process the ISO undertook an assessment of the Kern PP 70 kV sub-area in order to determine potential transmission alternatives to reduce or

eliminate the need for gas-fired generation. There is no gas-fired generation within the Kern PP 70 kV sub-area.

3.6.7.6 *South Kern PP Sub-area*

South Kern PP is a sub-area of the Kern LCR area.

3.6.7.6.1 *South Kern PP LCR Sub-area Diagram*

Figure 3.6-62 South Kern PP LCR Sub-area

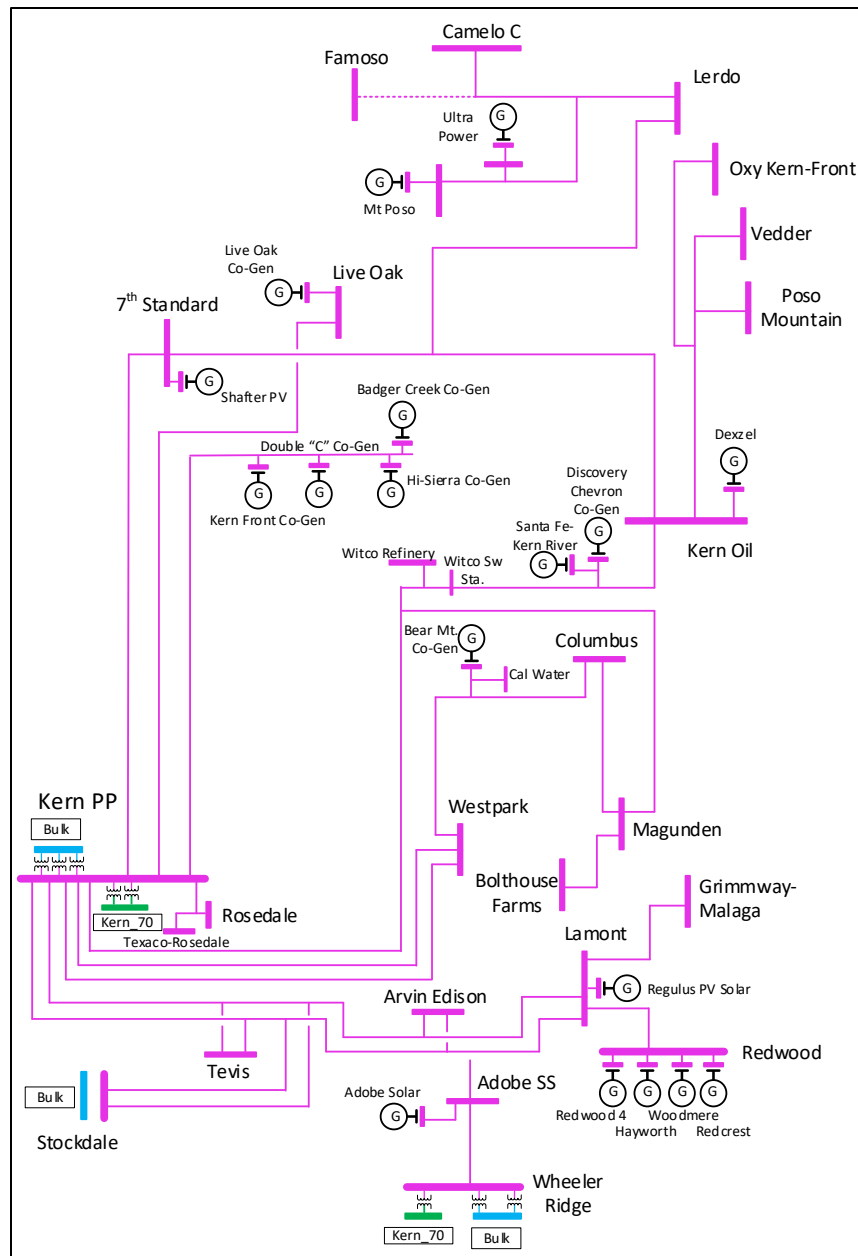

3.6.7.6.2 South Kern PP LCR Sub-area Load and Resources

Refer to Table 3.2-51 Kern Area Load and Resources table.

3.6.7.6.3 South Kern PP LCR Sub-area Hourly Profiles

Figure 3.6-63 illustrates the forecast 2030 profile for the summer peak, winter peak and spring off-peak days for the South Kern PP LCR sub-area with the Category P6 contingency transmission capability without resources. Figure 3.6-64 illustrates the forecast 2030 hourly profile for South Kern PP LCR sub-area with the Category P6 contingency transmission capability without resources.

Figure 3.6-63 South Kern PP LCR Sub-area 2030 Peak Day Forecast Profiles

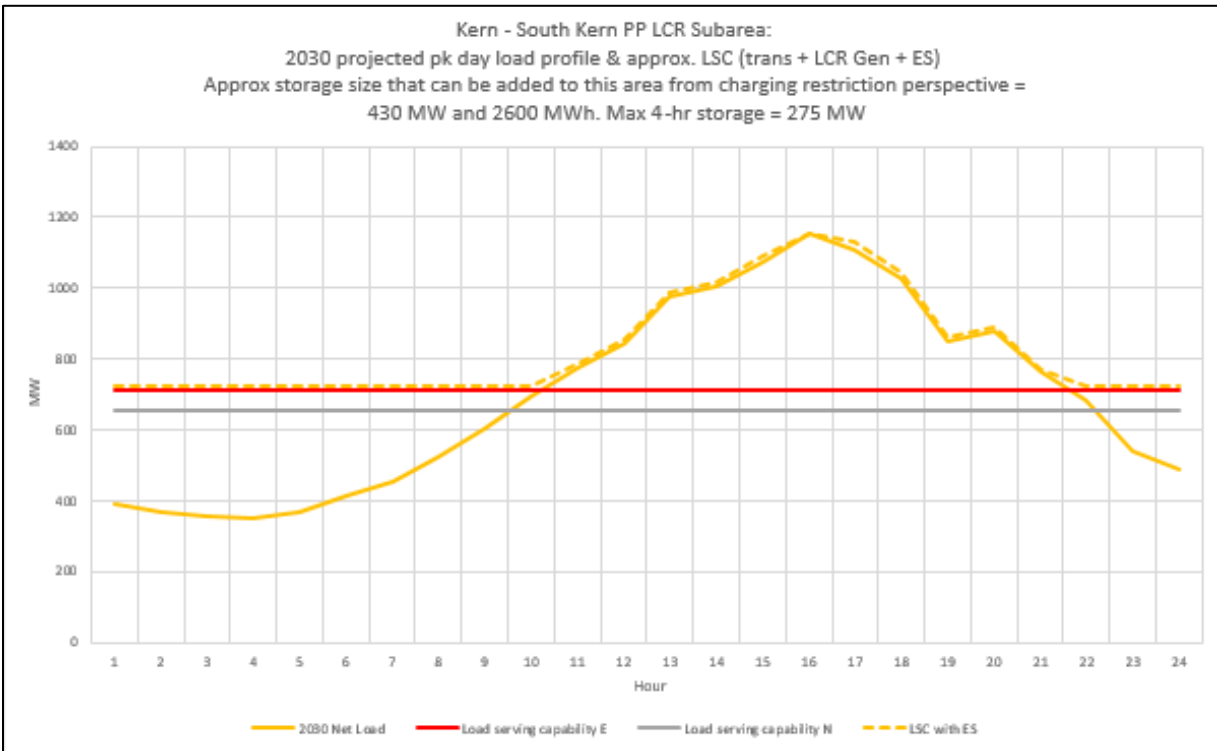
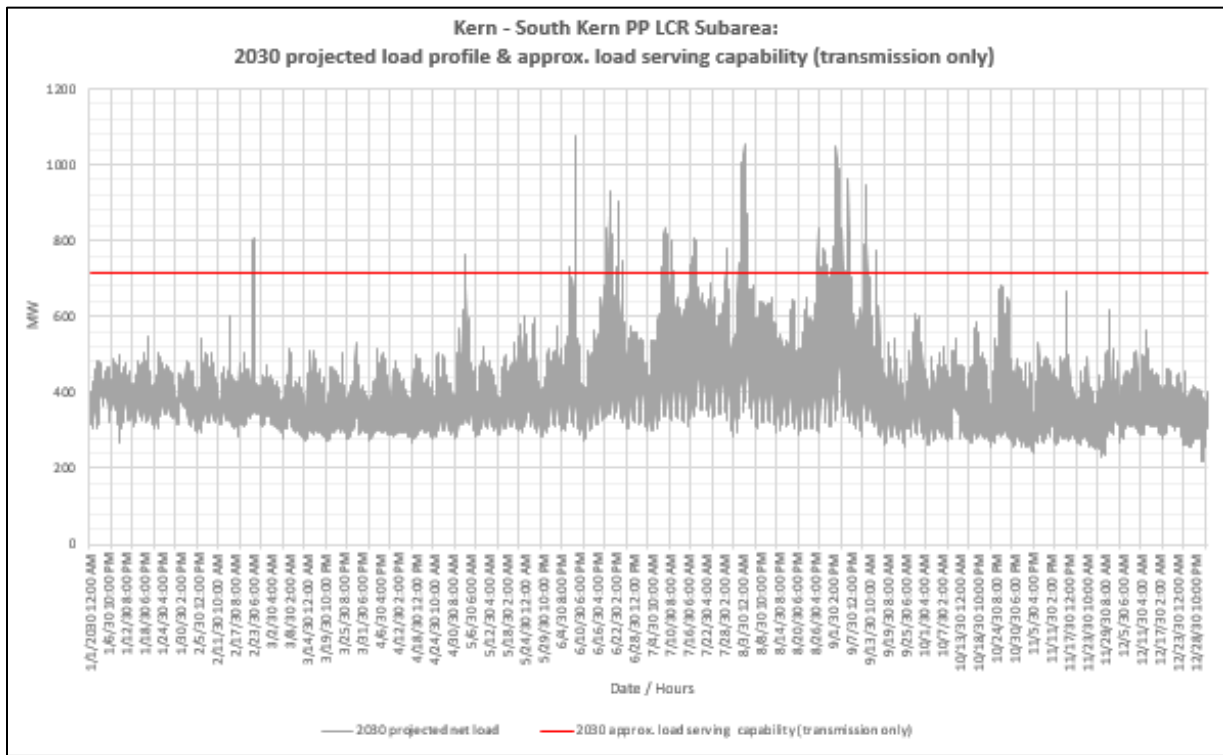

Figure 3.6-64 South Kern Overall LCR Area 2030 Forecast Hourly Profiles



3.6.7.6.4 South Kern PP LCR Sub-area Requirement

Table 3.6-58 identifies the sub-area LCR requirements. The LCR requirement for Category P6 contingency is 502 MW with a 167 MW deficiency at peak and 89 MW NQC deficiency.

Table 3.6-58 South Kern PP LCR Sub-area Requirements

Year	Limit	Category	Limiting Facility	Contingency	LCR (MW) (Deficiency)
2030	First Limit	P6	Kern 230/115 kV T/F # 5	Kern 230/115 kV T/F # 3 & Kern 230/115 kV T/F # 4	502 (167 at peak/ 89 NQC)

3.6.7.6.5 Effectiveness factors:

For most helpful procurement information please read procedure 2210Z Effectiveness Factors under 7450 posted at: <http://www.aiso.com/Documents/2210Z.pdf>

3.6.7.6.6 Alternatives to Reduce or Eliminate Gas Generation

In the 2020-2021 transmission planning process the South Kern LCR sub-area was not selected to assess alternatives to reduce or eliminate the requirement for gas-fired generation to address the LCR requirement.

As a part of the 2018-2019 transmission planning process the ISO undertook an assessment of the South Kern sub-area in order to determine potential transmission alternatives to reduce or eliminate the need for gas-fired generation.

3.6.7.7 Kern Area Overall Requirements

3.6.7.7.1 Kern LCR Area Overall Requirement

Table 3.6-59 identifies the limiting facility and contingency that establishes the Kern Area 2030 LCR requirements. The LCR requirement for Category P6 contingency the LCR requirement is 502 MW with a 89 MW NQC deficiency or 167 MW of at peak deficiency.

Table 3.6-59 Kern Overall LCR Sub-area Requirements

Year	Limit	Category	Limiting Facility	Contingency	LCR (MW) (Deficiency)
2030	N/A	P6	Aggregate of Sub-areas.		502 (89 NQC/ 167 Peak)

3.6.7.7.2 Changes compared to the 2025 LCT study

Due to the definition change, the load has decreased by 541 MW and the LCR requirement has increased by 230 MW. The definition change was triggered due to re-evaluation of the Wheeler Ridge Junction project (modeled in the 2025 case and not modeled in the 2030 case).

3.6.7.7.3 Alternatives to Reduce or Eliminate Gas Generation

In the 2020-2021 transmission planning process the Kern overall LCR area was not selected to assess alternatives to reduce or eliminate the requirement for gas-fired generation to address the LCR requirement.

As a part of the 2018-2019 and 2019-2020 transmission planning process the ISO undertook an assessment of the Kern overall area in order to determine potential transmission alternatives to reduce or eliminate the need for gas-fired generation.

3.6.8 Big Creek/Ventura Area

3.6.8.1 Area Definition:

The transmission tie lines into the Big Creek/Ventura Area are:

- Antelope #1 500/230 kV Transformer
- Antelope #2 500/230 kV Transformer
- Sylmar - Pardee 230 kV #1 and #2 Lines
- Vincent - Pardee 230 kV #2 Line
- Vincent - Santa Clara 230 kV Line

The substations that delineate the Big Creek/Ventura Area are:

- Antelope 500 kV is out Antelope 230 kV is in
- Antelope 500 kV is out Antelope 230 kV is in
- Sylmar is out Pardee is in
- Vincent is out Pardee is in
- Vincent is out Santa Clara is in

3.6.8.1.1 Big Creek/Ventura LCR Area Diagram

Figure 3.6-65 Big Creek/Ventura LCR Area

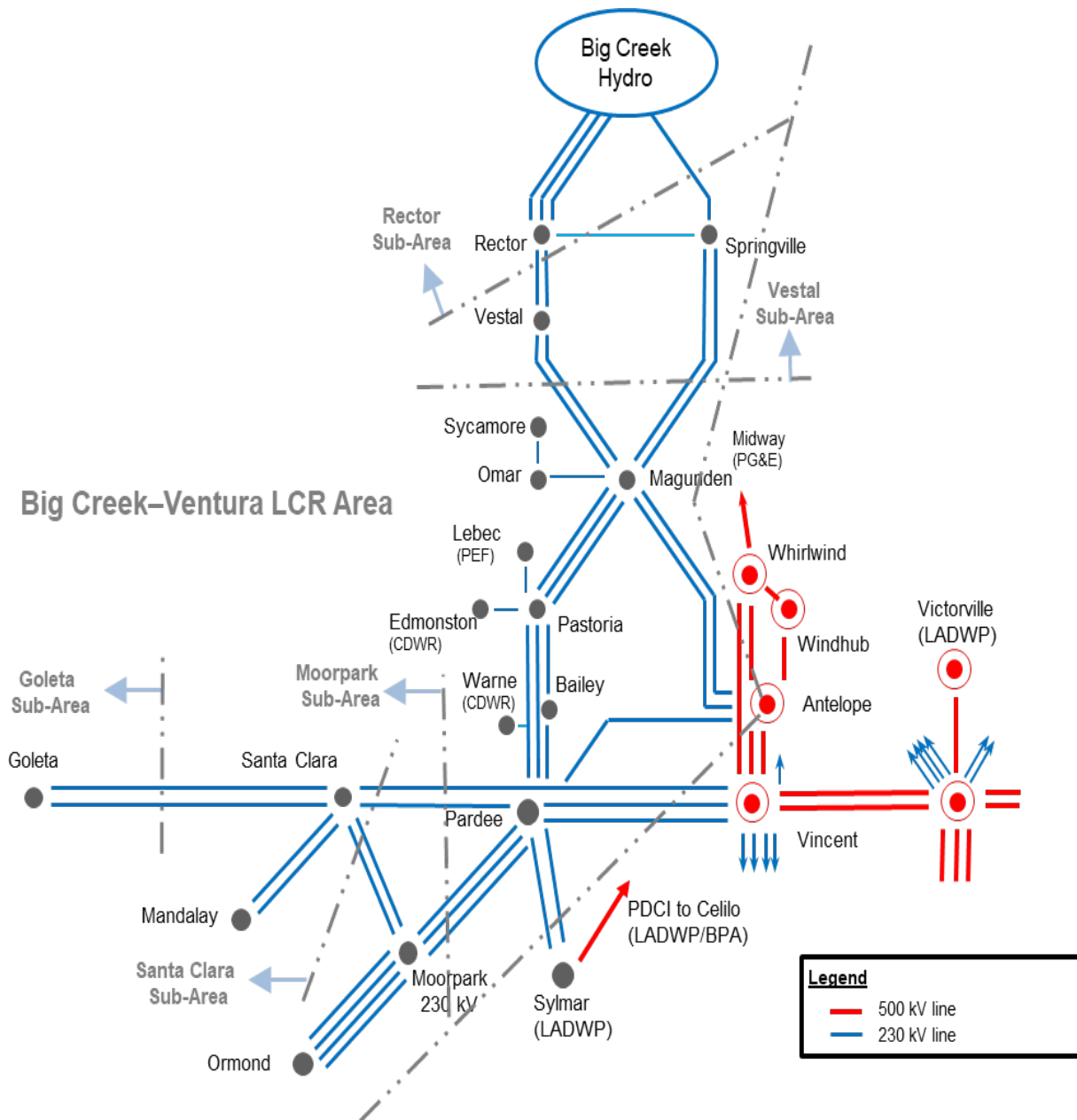

3.6.8.1.2 Big Creek/Ventura LCR Area Load and Resources

Table 3.6-60 provides the forecast load and resources in the Big Creek/Ventura LCR area in 2030. The list of generators within the LCR area are provided in Attachment A and does not include new LTPP Preferred resources or existing DR.

In year 2030 the estimated time of local area peak is hour ending 19:00 PST (HE 20:00 PDT).

At the local area peak time the estimated, ISO-metered solar output is 0.0%.

If required, all non-solar technology type resources are dispatched at NQC.

Table 3.6-60 Big Creek/Ventura LCR Area 2030 Forecast Load and Resources

Load (MW)		Generation (MW)	Aug NQC	At Peak
Gross Load	4293	Market, Net Seller, Battery, Wind	3132	3132
AAEE	-106	MUNI	312	312
Behind the meter DG	0	QF	112	112
Net Load	4187	Solar	250	0
Transmission Losses	68	Other preferred resources and storage	25	20
Pumps	223	Existing Demand Response	63	63
Load + Losses + Pumps	4478	Total	3894	3644

3.6.8.1.3 Approved transmission projects modeled:

Pardee-Moorpark No. 4 230 kV Transmission Circuit (ISD – 6/1/2021)

Pardee-Sylmar 230 kV Rating Increase Project (ISD- 5/31/2023)

3.6.8.2 Rector Sub-area

LCR need is satisfied by the need in the larger Vestal sub-area.

3.6.8.3 Vestal Sub-area

Vestal is a sub-area of the Big Creek/Ventura LCR area.

3.6.8.3.1 Vestal LCR Sub-area Diagram

Figure 3.6-66 Vestal LCR Sub-area

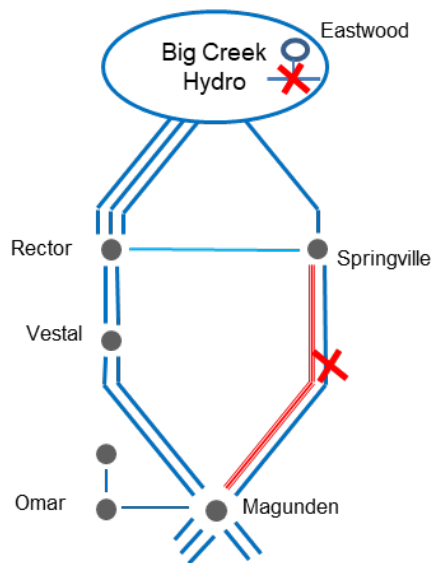

3.6.8.3.2 Vestal LCR Sub-area Load and Resources

Table 3.6-61 provides the forecast load and resources in Vestal LCR sub-area in 2030. The list of generators within the LCR sub-area is provided in Attachment A.

Table 3.6-61 Vestal LCR Sub-area 2030 Forecast Load and Resources

Load (MW)		Generation (MW)	Aug NQC	At Peak
Gross Load	1287	Market, Net Seller, Battery, Wind	1055	1055
AAEE	31	MUNI	0	0
Behind the meter DG	0	QF	22	22
Net Load	1256	Solar	9	0
Transmission Losses	31	Other preferred resources and storage	0	0
Pumps	0	Existing 20-minute Demand Response	27	27
Load + Losses + Pumps	1287	Total	1113	1104

3.6.8.3.3 Vestal LCR Sub-area Requirement

Table 3.6-62 identifies the sub-area LCR requirements. The 2030 LCR requirement for Category P3 contingency is 434 MW.

Table 3.6-62 Vestal LCR Sub-area Requirements

Year	Limit	Category	Limiting Facility	Contingency	LCR (MW) (Deficiency)
2030	First Limit	P3	Magunden–Springville #2 230 kV line	Magunden–Springville #1 230 kV line with Eastwood out of service	434
2030	Second Limit ⁶	P3	Magunden–Vestal 230 kV lines	One Magunden–Vestal 230 kV line with Eastwood out of service	419

3.6.8.3.4 Effectiveness factors:

For helpful procurement information please read procedure 2210Z Effectiveness Factors under 7500 posted at: <http://www.caiso.com/Documents/2210Z.pdf>

⁶ Due to the larger difference between normal and emergency ratings of the limiting facility associated with the second limit compared to that associated with the first limit, the second limit is the binding constraint for energy storage local capacity. Therefore, the energy storage local capacity analysis is performed based on the second limit

3.6.8.3.5 Vestal LCR Sub-area Hourly Profiles

Figure 3.6-69 illustrates the forecast 2030 profile for the peak day for the Vestal LCR sub-area along with the Category P3 normal and emergency load serving capabilities without local capacity resources. The chart also includes an estimated amount of energy storage that can be added to this local area from charging restriction perspective and the amount of 4-hour storage that can be added to replace local capacity on a 1 MW for 1 MWh basis. Figure 3.6-70 illustrates the forecast 2030 hourly profile for Vestal LCR sub-area along with the Category P3 emergency load serving capability without local capacity resources.

Figure 3.6-67 Vestal LCR Sub-area 2030 Peak Day Forecast Profiles

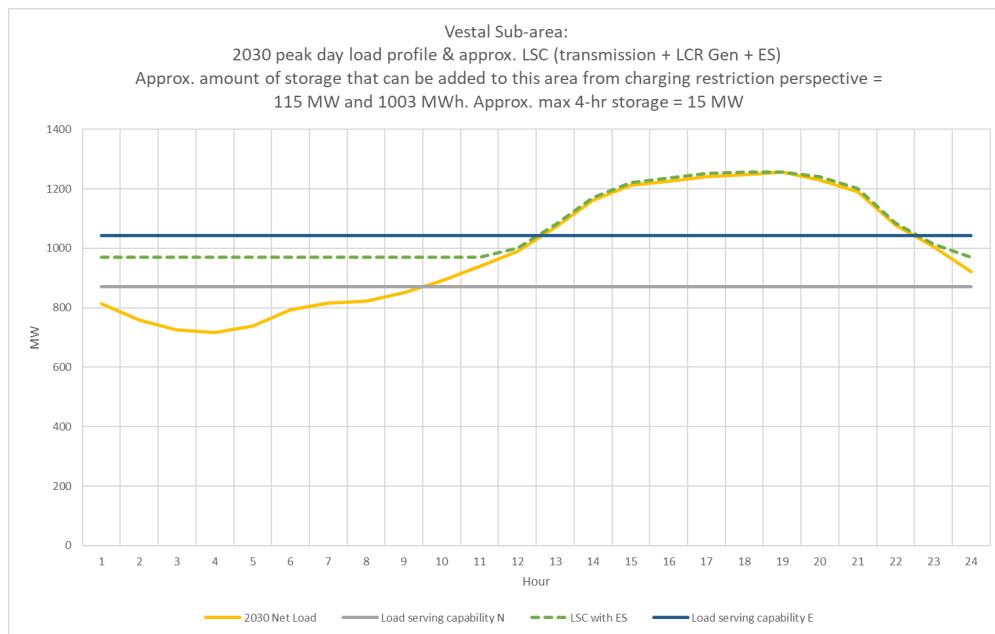
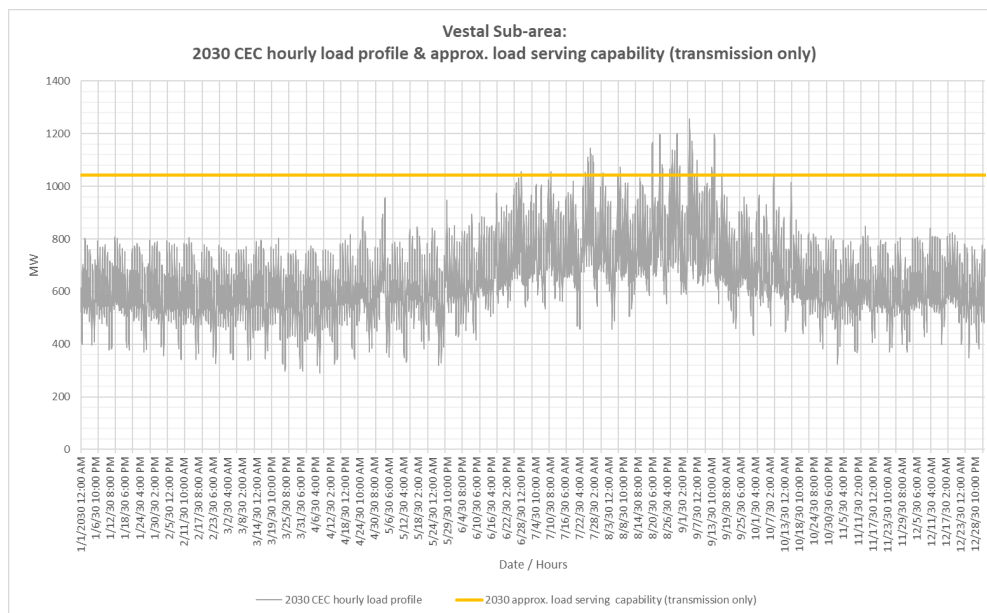

Figure 3.6-68 Vestal Sub-area 2030 Forecast Hourly Profile



3.6.8.3.6 Alternatives to Reduce or Eliminate Gas Generation

In the 2020-2021 transmission planning process the Vestal sub-area was not selected to assess alternatives to reduce or eliminate the requirement for gas-fired generation to address the LCR requirement.

As a part of the 2018-2019 transmission planning process the ISO undertook an assessment of the Vestal sub-area in order to determine potential transmission alternatives to reduce or eliminate the need for gas-fired generation. The 2028 LCT study identified that the requirement in the Vestal sub-area can be addressed with non-gas generation.

3.6.8.4 Goleta Sub-area

Goleta is a sub-area of the Big Creek/Ventura LCR area.

The LCR need is satisfied by the need in the larger Santa Clara sub-area.

3.6.8.5 Santa Clara Sub-area

Santa Clara is a sub-area of the Big Creek/Ventura LCR area.

3.6.8.5.1 Santa Clara LCR Sub-area Diagram

Figure 3.6-69 Santa Clara LCR Sub-area

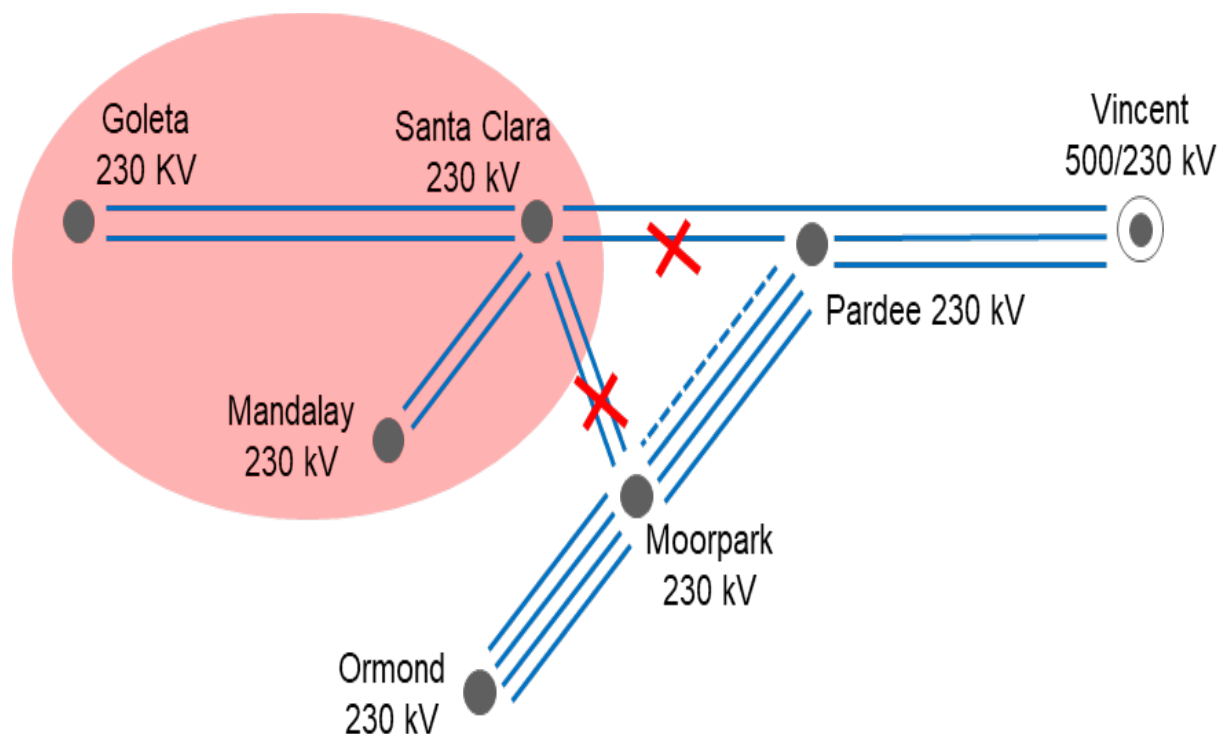

3.6.8.5.2 Santa Clara LCR Sub-area Load and Resources

Table 3.6-63 provides the forecast load and resources in Santa Clara LCR sub-area in 2030. The list of generators within the LCR sub-area are provided in Attachment A.

Table 3.6-63 Santa Clara LCR Sub-area 2030 Forecast Load and Resources

Load (MW)		Generation (MW)	Aug NQC	At Peak
Gross Load	806	Market, Battery	283	283
AAEE	19	MUNI	0	0
Behind the meter DG	0	QF	84	84
Net Load	787	Other preferred resources and storage	16	15
Transmission Losses	3	Existing Demand Response	5	5
Pumps	0	Mothballed	0	0
Load + Losses + Pumps	790	Total	388	387

3.6.8.5.3 Santa Clara LCR Sub-area Requirement

Table 3.6-64 identifies the sub-area requirement. The 2030 LCR requirement for Category P1 + P7 contingency is 191 MW.

Table 3.6-64 Santa Clara LCR Sub-area Requirements

Year	Limit	Category	Limiting Facility	Contingency	LCR (MW) (Deficiency)
2030	First Limit	P1 + P7	Voltage collapse	Pardee - Santa Clara 230 kV followed by Moorpark - Santa Clara #1 & #2 230 kV	191

3.6.8.5.4 Santa Clara LCR Sub-area Hourly Profiles

Figure 3.6-74 illustrates the forecast 2030 profile for the peak day for the Santa Clara sub-area along with the Category P1+P7 load serving capability without local capacity resources. The chart also includes an estimated amount of energy storage that can be added to this local area from charging restriction perspective and the amount of 4-hour storage that can be added to replace local capacity on a 1 MW for 1 MW basis. Figure 3.6-75 illustrates the forecast 2030 hourly profile for Santa Clara sub-area along with the Category P1+P7 emergency load serving capability without local capacity resources.

Figure 3.6-70 Santa Clara LCR Sub-area 2030 Peak Day Forecast Profiles

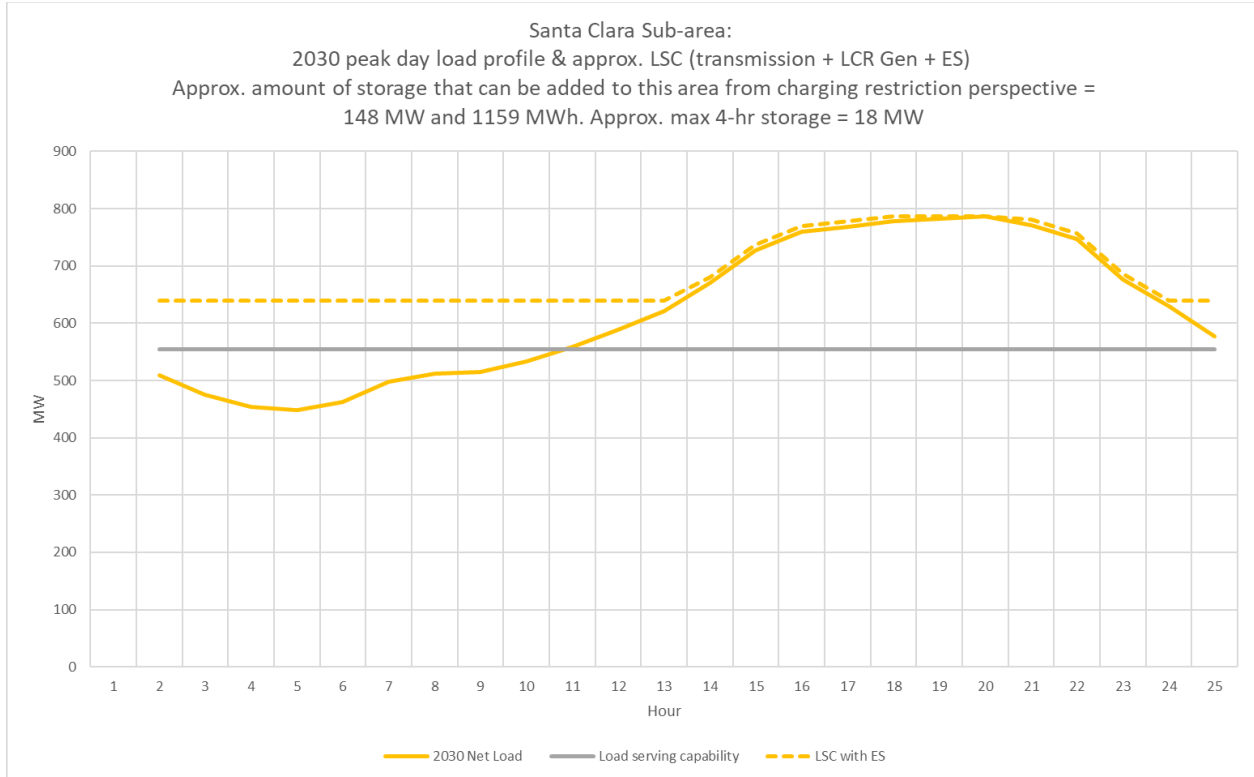
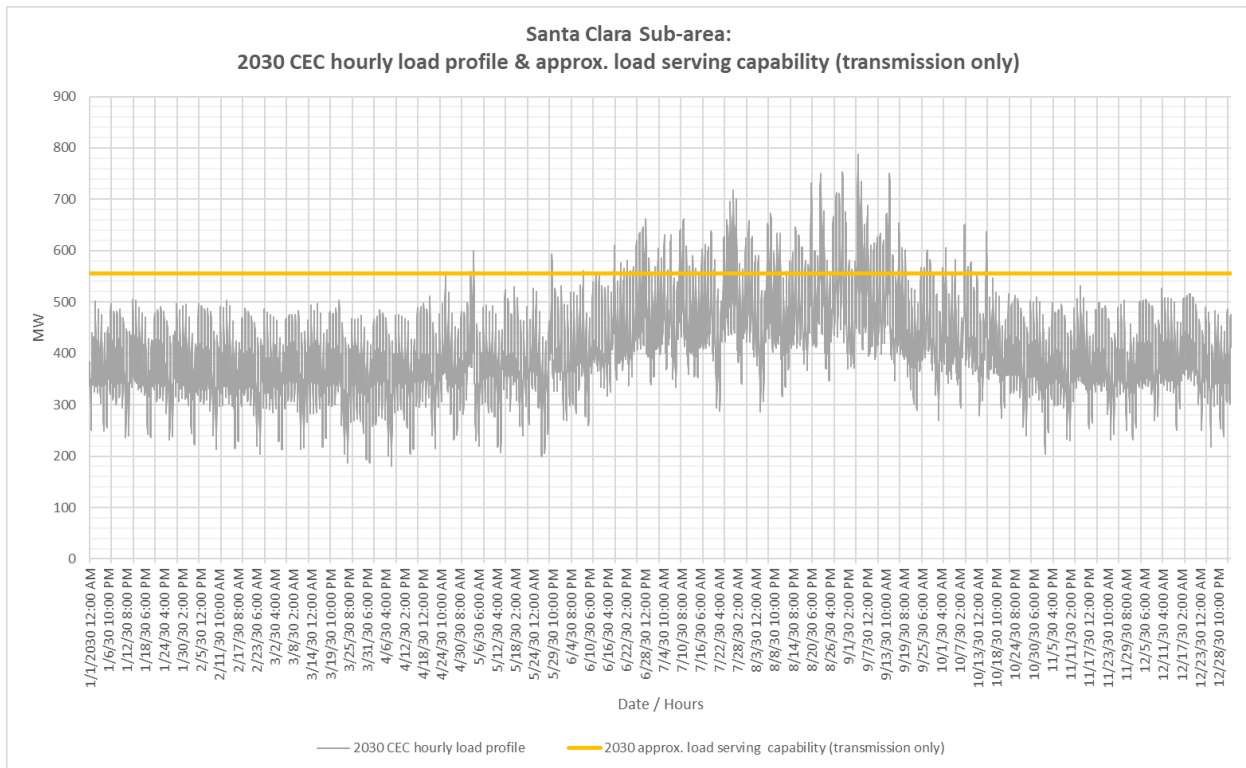

Figure 3.6-71 Santa Clara Sub-area 2030 Forecast Hourly Profiles



3.6.8.5.5 Effectiveness factors:

For helpful procurement information please read procedure 2210Z Effectiveness Factors under 7500, 7510, 7550, 7680 and 8610 posted at: <http://www.caiso.com/Documents/2210Z.pdf>

3.6.8.5.6 Alternatives to Reduce or Eliminate Gas Generation

In the 2020-2021 transmission planning process the Santa Clara sub-area was not selected to assess alternatives to reduce or eliminate the requirement for gas-fired generation to address the LCR requirement.

As a part of the 2019-2020 transmission planning process the ISO undertook an assessment of the Santa Clara sub-area in order to determine potential transmission alternatives to reduce or eliminate the need for gas-fired generation.

3.6.8.6 Moorpark Sub-area

Moorpark is a sub-area of the Big Creek/Ventura LCR area.

No requirement is identified for the sub-area due to the Pardee-Moorpark No. 4 230 kV Transmission Project.

3.6.8.7 Big Creek/Ventura Overall**3.6.8.7.1 Big Creek/Ventura LCR area Requirement**

Table 3.2-65 identifies the area LCR requirements. The LCR requirement for Category P6 contingency is 1151 MW.

Table 3.6-65 Big Creek/Ventura LCR area Requirements

Year	Limit	Category	Limiting Facility	Contingency	LCR (MW)
2030	First limit	P6	Remaining Sylmar - Pardee 230 kV	Lugo - Victorville 500 kV line followed by one of the Sylmar - Pardee #1 or #2 230 kV lines	1151

3.6.8.7.2 Effectiveness factors:

For helpful procurement information please read procedure 2210Z Effectiveness Factors under 7500, 7510, 7550, 7680 and 8610 posted at: <http://www.caiso.com/Documents/2210Z.pdf>

3.6.8.7.3 Changes compared to the 2025 LCT study

The load forecast is up by 49 MW and the LCR went up by 149 MW mostly due to load increase.

3.6.8.7.4 Big Creek/Ventura LCR Sub-area Hourly Profiles

Figure 3.6-75 illustrates the forecast 2030 profile for the peak day for Big Creek/Ventura area along with the Category P6 normal and emergency load serving capability without local capacity resources. The chart also includes an estimated amount of energy storage that can be added to

this local area from charging restriction perspective and the amount of 4-hour storage that can be added to replace local capacity on a 1 MW for 1 MW basis. Figure 3.6-76 illustrates the forecast 2030 hourly profile for Santa Clara sub-area along with the Category P6 emergency load serving capability without local capacity resources.

Figure 3.6-72 Big Creek/Ventura LCR area 2030 Peak Day Forecast Profiles

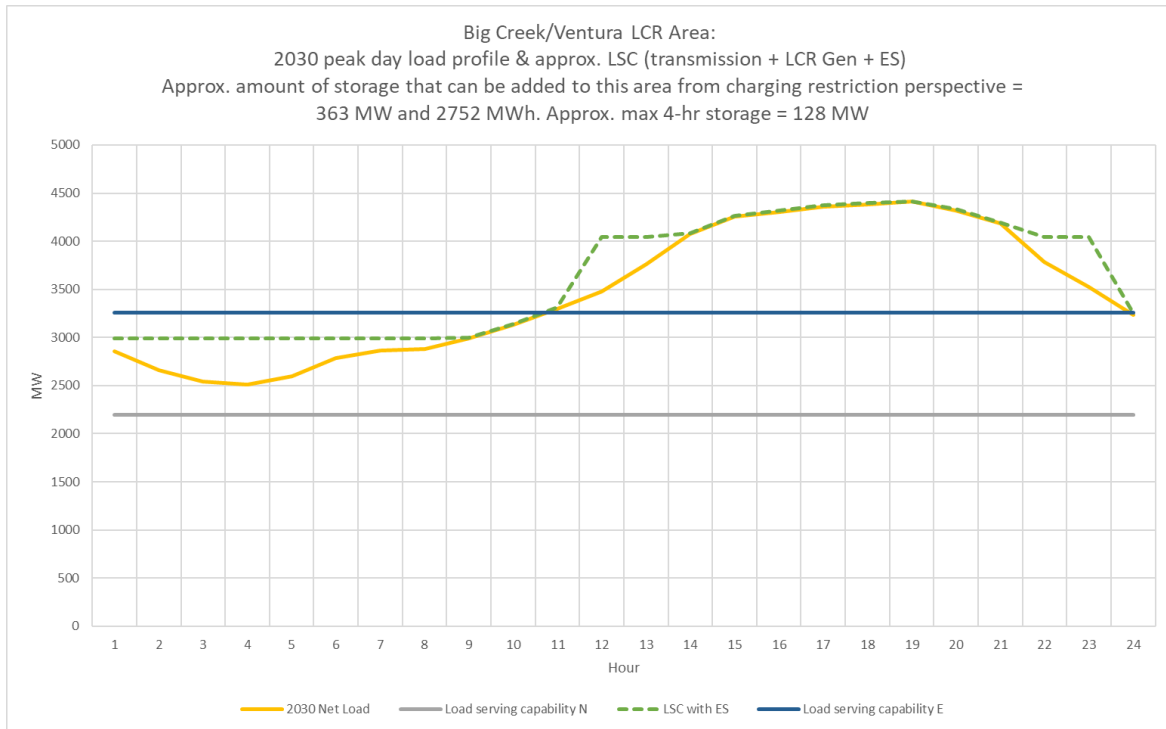
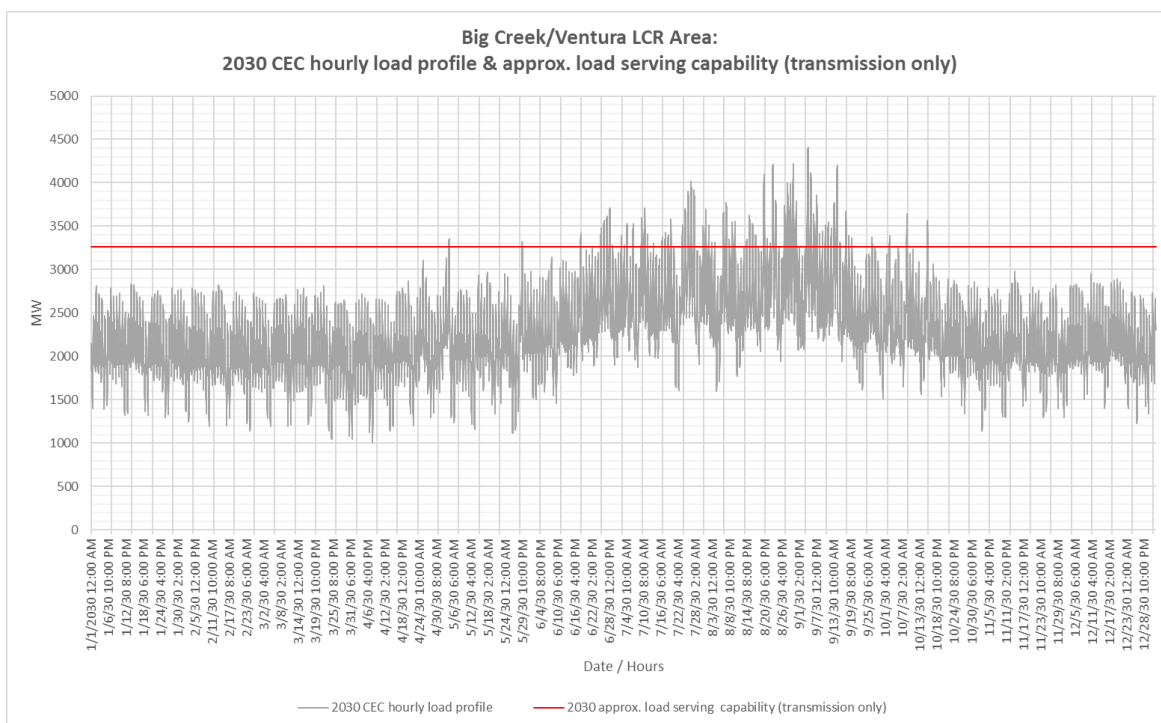

Figure 3.6-73 Big Creek/Ventura LCR area 2030 Peak Day Forecast Profiles



3.6.8.7.5 Alternatives to Reduce or Eliminate Gas Generation

In the 2020-2021 transmission planning process the Big Creek-Ventura overall area was not selected to assess alternatives to reduce or eliminate the requirement for gas-fired generation to address the LCR requirement.

As a part of the 2019-2020 transmission planning process the ISO undertook an assessment of the Big Creek-Ventura overall area in order to determine potential transmission alternatives to reduce or eliminate the need for gas-fired generation. The following alternatives were considered.

- Pardee-Sylmar lines rating increase
- Pacific Transmission Expansion (PTE) HVDC

The Pardee-Sylmar Line rating increase project was approved as a reliability project with economic benefits derived from LCR and production cost reduction. The PTE was found to reduce the Big Creek/Ventura LCR requirement by approximately 393 MW due to its 500 MW terminal at Goleta.

The PTE project with some configuration alternatives is being assessed in the current planning cycle as part of LA Basin local capacity area assessment. Since the configuration of the project in the Big Creek/Ventura area has not changed from last year, its LCR reduction benefit in the area is not expected to change. As a result, the project's LCR reduction benefit with respect to the Big Creek/Ventura area determined in the previous planning cycle will be used as an input in the assessment performed as part of the LA Basin local capacity area.

3.6.9 LA Basin Area

3.6.9.1 *Area Definition:*

The transmission tie lines into the LA Basin Area are:

- San Onofre - San Luis Rey #1, #2, and #3 230 kV Lines
- San Onofre - Talega #2 230 kV Lines
- San Onofre - Capistrano #1 230 kV Lines
- Lugo - Mira Loma #2 & #3 500 kV Lines
- Lugo - Rancho Vista #1 500 kV Line
- Vincent – Mesa 500 kV Line
- Sylmar - Eagle Rock 230 kV Line
- Sylmar - Gould 230 kV Line
- Vincent - Mesa #1 & #2 230 kV Lines
- Vincent - Rio Hondo #1 & #2 230 kV Lines
- Devers - Red Bluff 500 kV #1 and #2 Lines
- Mirage – Coachela Valley # 1 230 kV Line
- Mirage - Ramon # 1 230 kV Line
- Mirage - Julian Hinds 230 kV Line

The substations that delineate the LA Basin Area are:

- San Onofre is in San Luis Rey is out
- San Onofre is in Talega is out
- San Onofre is in Capistrano is out
- Mira Loma is in Lugo is out
- Rancho Vista is in Lugo is out
- Eagle Rock is in Sylmar is out
- Gould is in Sylmar is out
- Mira Loma is in Vincent is out
- Mesa is in Vincent is out
- Rio Hondo is in Vincent is out
- Devers is in Red Bluff is out
- Mirage is in Coachela Valley is out

Mirage is in Ramon is out

Mirage is in Julian Hinds is out

3.6.9.1.1 LA Basin LCR Area Diagram

Figure 3.6-74 LA Basin LCR Area

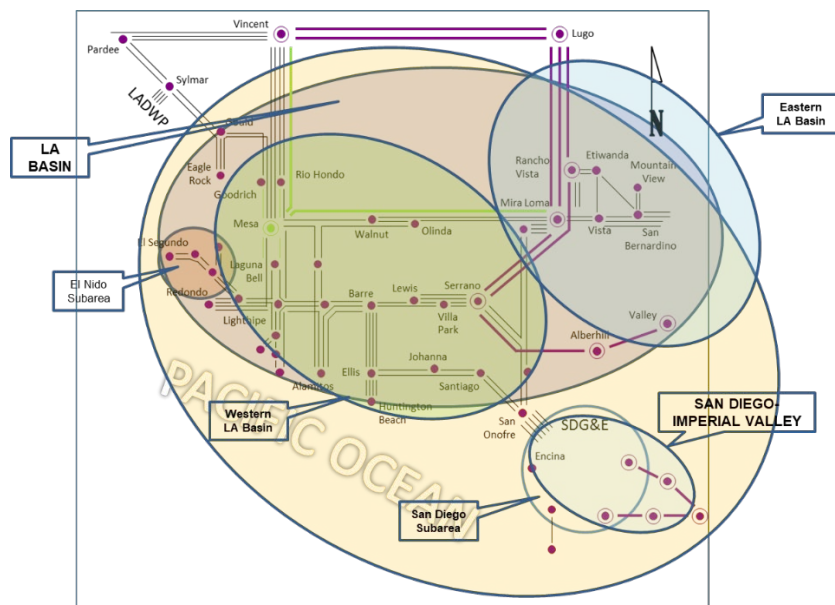

3.6.9.1.2 LA Basin LCR Area Load and Resources

Table 3.2-67 provides the forecast load and resources in the LA Basin LCR area in 2030. The list of generators within the LCR area are provided in Attachment A and does not include new LTPP Preferred resources or DR.

In year 2030 the estimated time of local area peak is 8:00 PM (PDT) on September 3, 2030.

At the local area peak time the estimated, ISO metered, solar output is 0%.

If required, all non-solar technology type resources are dispatched at NQC.

Table 3.6-66 LA Basin LCR Area 2030 Forecast Load and Resources

Load (MW)		Generation (MW)	Aug NQC	At Peak
Gross Load	19503	Market, Net Seller, Battery, Wind	5597	5597
AEE	-563	MUNI	1056	1056
Behind the meter DG	0	QF	141	141
Net Load	18940	LTPP Preferred Resources (BTM BESS, EE, DR, PV)	331	208
Transmission Losses	284	Existing Demand Response	259	259

Pumps	20	Solar	11	0
Load + Losses + Pumps	19244	Total	7395	7261

3.6.9.1.3 Approved transmission projects modeled:

Mesa Loop-In Project and Laguna Bell Corridor 230 kV line upgrades

Delaney – Colorado River 500 kV Line

Hassayampa – North Gila #2 500 kV Line (APS)

West of Devers 230 kV line upgrades

CPUC-approved long-term procurement plan (431 MW) for preferred resources in the western LA Basin sub-area

Retirement of 1,356 MW of the existing Redondo Beach OTC generation

Alamitos repowering (640 MW)

Retirement of 2,010 MW of the existing Alamitos OTC generation

Huntington Beach repowering (644 MW)

Retirement of 452 MW of the existing Huntington Beach OTC generation

Stanton Energy Reliability Center (98 MW)

3.6.9.2 *El Nido Sub-area*

El Nido is a sub-area of the LA Basin LCR area.

3.6.9.2.1 El Nido LCR Sub-area Diagram

Please refer to Figure 3.6-74 above.

3.6.9.2.2 El Nido LCR Sub-area Load and Resources

Table 3.6-67 provides the forecast load and resources in El Nido LCR sub-area in 2030. The list of generators within the LCR sub-area are provided in Attachment A.

Table 3.6-67 El Nido LCR Sub-area 2030 Forecast Load and Resources

Load (MW)		Generation (MW)	Aug NQC	At Peak
Gross Load	1054	Market, Net Seller, Battery, Wind, Solar	534	534
AAEE	-34	MUNI	3	3
Behind the meter DG	0	QF	0	0
Net Load	1020	LTPP Preferred Resources	23	23
Transmission Losses	2	Existing Demand Response	9	9

Pumps	0	Mothballed	0	0
Load + Losses + Pumps	1022	Total	569	569

3.6.9.2.3 El Nido LCR Sub-area Hourly Profiles

Figure 3.6-75 illustrates the forecast 2030 profile for the summer peak day in the El Nido LCR sub-area with the Category P7 normal and emergency load serving capabilities without local capacity resources.

Figure 3.6-76 and Figure 3.6-77 illustrate hourly load profiles with transmission only load serving capability and estimated amount of storage that can be added based on charging restriction. For this case, an estimated 231 MW and 1587 MWh of energy storage can be accommodated from the charging limitation perspective as shown on Figure 3.6-77. The estimated amount of 4-hour energy storage is 91 MW.

Figure 3.6-75 El Nido LCR Sub-area 2030 Peak Day Forecast Profiles

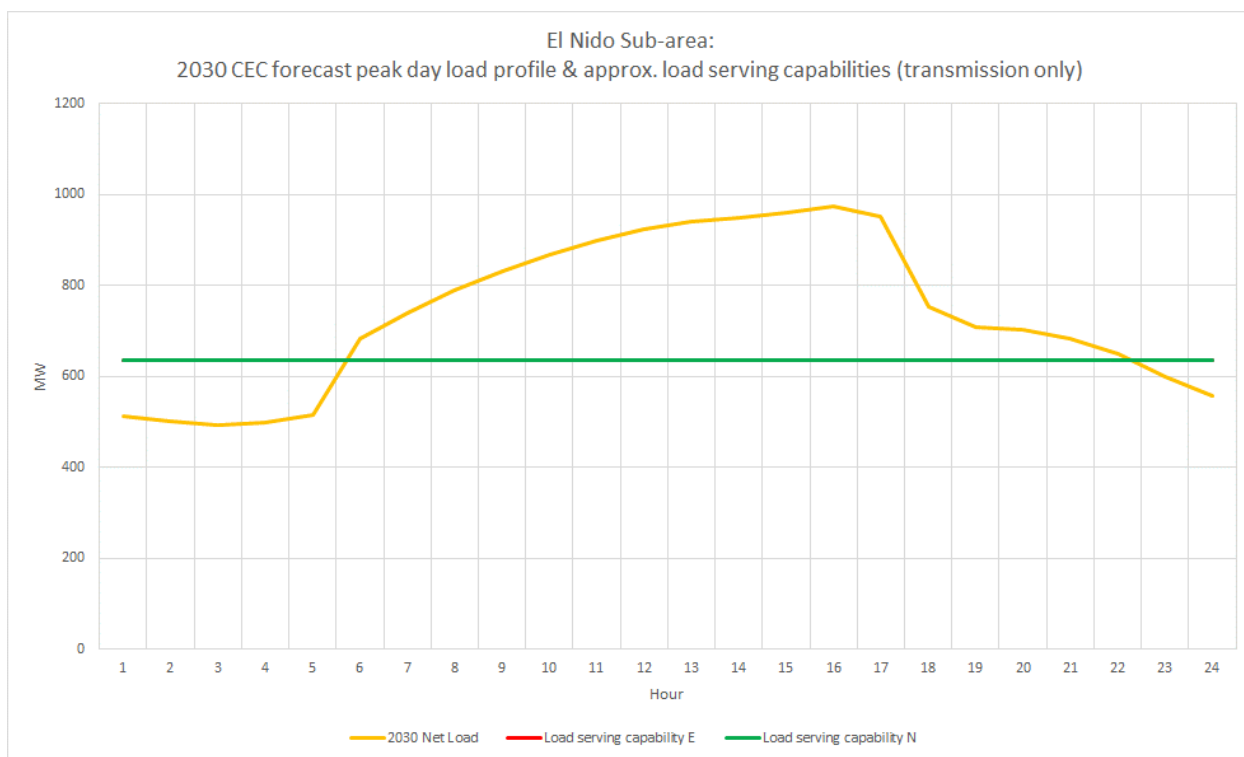

Figure 3.6-76 El Nido LCR Sub-area 2030 Hourly Load Profile and Approximate Load Serving Capability (Transmission Only)

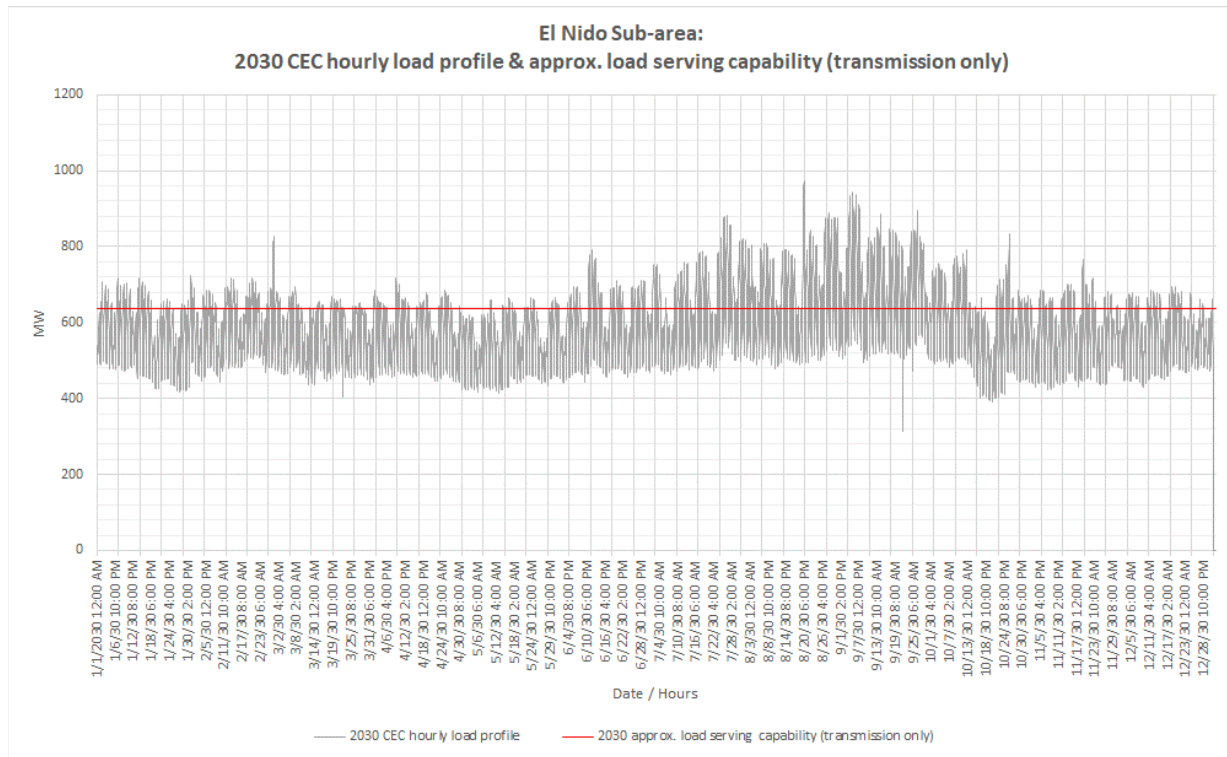
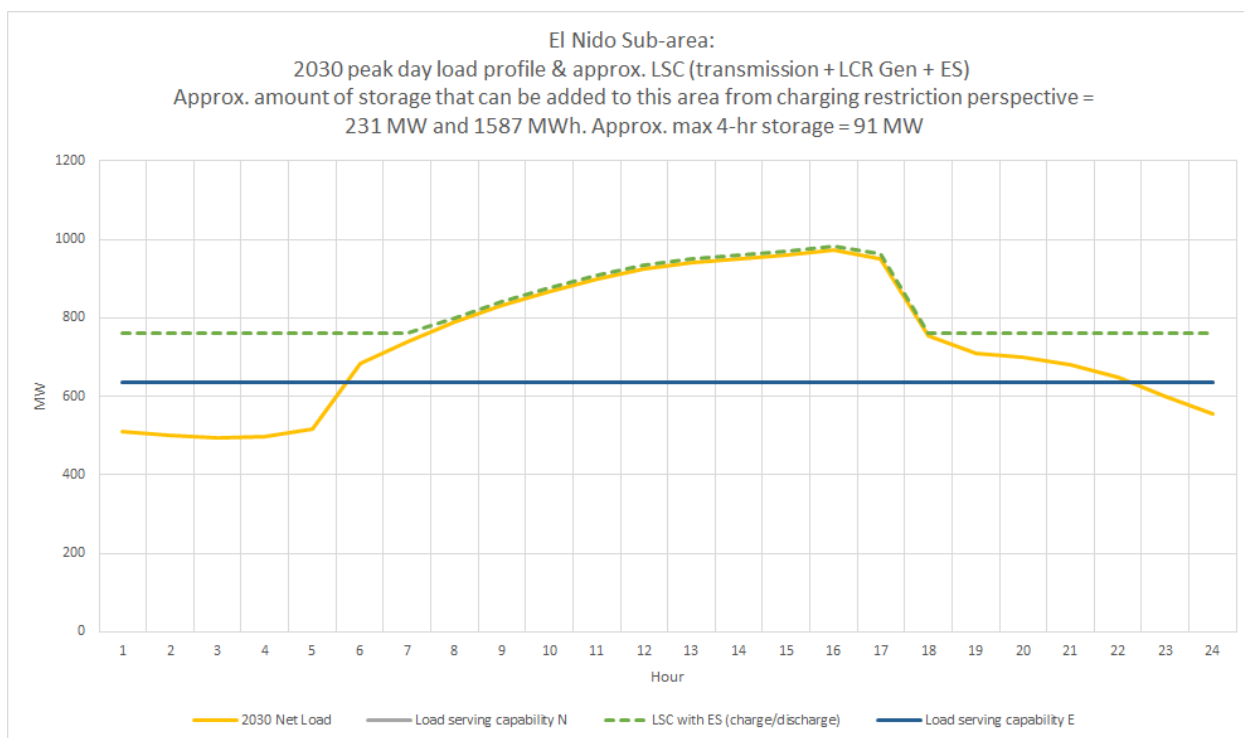

Figure 3.6-77 El Nido LCR Sub-area 2030 Estimated Amount of Storage that Can Be Added Based on Charging Restriction



3.6.9.2.4 El Nido LCR Sub-area Requirement

Table 3.6-68 identifies the sub-area requirements. The LCR requirement for Category P7 contingency is 355 MW.

Table 3.6-68 El Nido LCR Sub-area Requirements

Year	Limit	Category	Limiting Facility	Contingency	LCR (MW) (Deficiency)
2030	First Limit	P7	La Fresa-La Cienega 230 kV	La Fresa – El Nido #3 & #4 230 kV	355

3.6.9.2.5 Effectiveness factors:

All units within the El Nido Sub-area have the same effectiveness factor.

For most helpful procurement information please read procedure 2210Z Effectiveness Factors under 7630 posted at: <http://www.caiso.com/Documents/2210Z.pdf>

3.6.9.2.6 Alternatives to Reduce or Eliminate Gas Generation

In the 2020-2021 transmission planning process the El Nido sub-area was not selected to assess alternatives to reduce or eliminate the requirement for gas-fired generation to address the LCR requirement.

As a part of the 2019-2020 transmission planning process the ISO undertook an assessment of the El Nido sub-area in order to determine potential transmission alternatives to reduce or eliminate the need for gas-fired generation.

3.6.9.3 *Western LA Basin Sub-area*

Western LA Basin is a sub-area of the LA Basin LCR area.

3.6.9.3.1 Western LA Basin LCR Sub-area Diagram

Please refer to Figure 3.6-74 above.

3.6.9.3.2 Western LA Basin LCR Sub-area Load and Resources

Table 3.6-69 provides the forecast load and resources in Western LA Basin LCR sub-area in 2030. The list of generators within the LCR sub-area are provided in Attachment A.

Table 3.6-69 Western LA Basin Sub-area 2030 Forecast Load and Resources

Load (MW)		Generation (MW)	Aug NQC	At Peak
Gross Load	12244	Market, Net Seller, Battery, Wind	3212	3212
AAEE	-466	MUNI	584	584
Behind the meter DG	0	QF	58	58
Net Load	11778	LTPP Preferred Resources (BTM BESS, EE, DR, PV)	331	316
Transmission Losses	225	Existing Demand Response	161	161
Pumps	0	Solar	2	0
Load + Losses + Pumps	12003	Total	4348	4331

3.6.9.3.3 Western LA Basin LCR Sub-area Hourly Profiles

Figure 3.6-78 illustrates the forecast 2030 profile for the summer peak day in the Western LA Basin LCR sub-area with the Category P1 normal and emergency load serving capabilities without local capacity resources.

Figure 3.6-79 and Figure 3.6-80 illustrate hourly load profiles with transmission only load serving capability and estimated amount of storage that can be added based on charging restriction. For this case, an estimated 1510 MW and 12348 MWh of energy storage can be accommodated from the charging limitation perspective as shown on Figure 3.6-80. The estimated amount of 4-hour energy storage is 420 MW.

Figure 3.6-78 Western LA Basin LCR Sub-area 2030 Peak Day Forecast Profiles

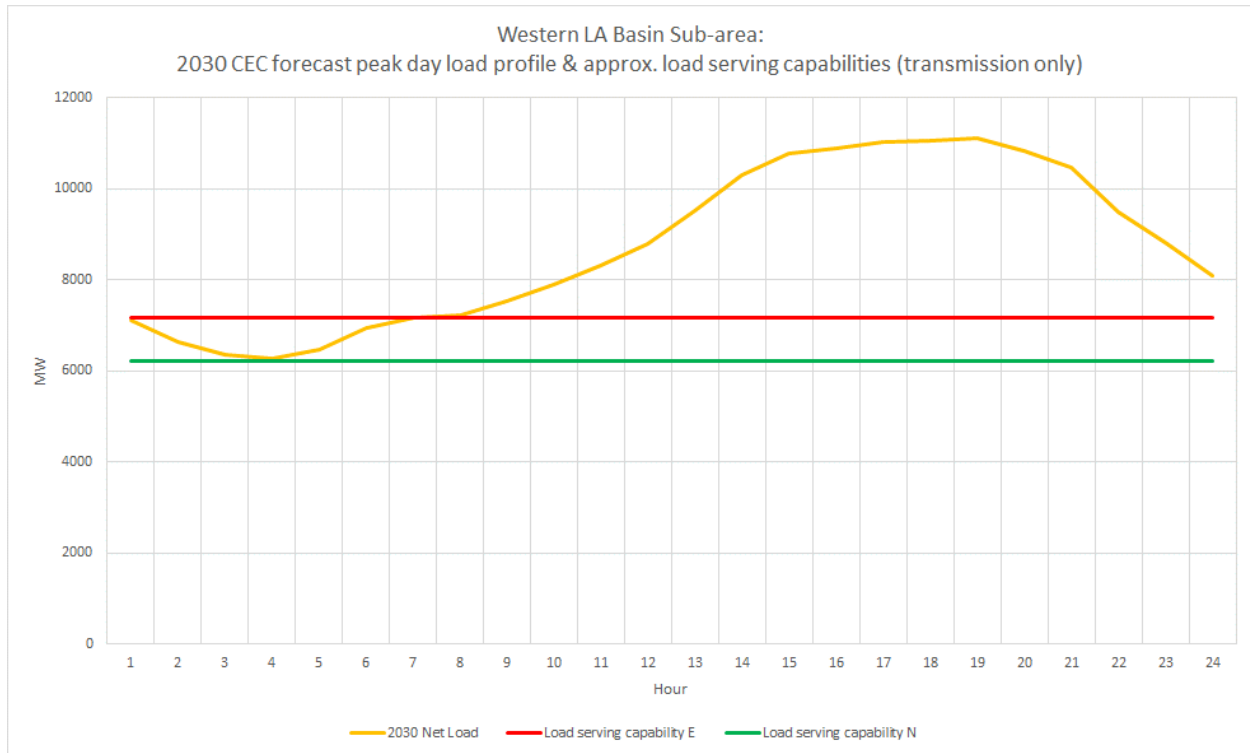

Figure 3.6-79 Western LA Basin LCR Sub-area 2030 Hourly Load Forecast Profiles with Transmission Only Load Serving Capability

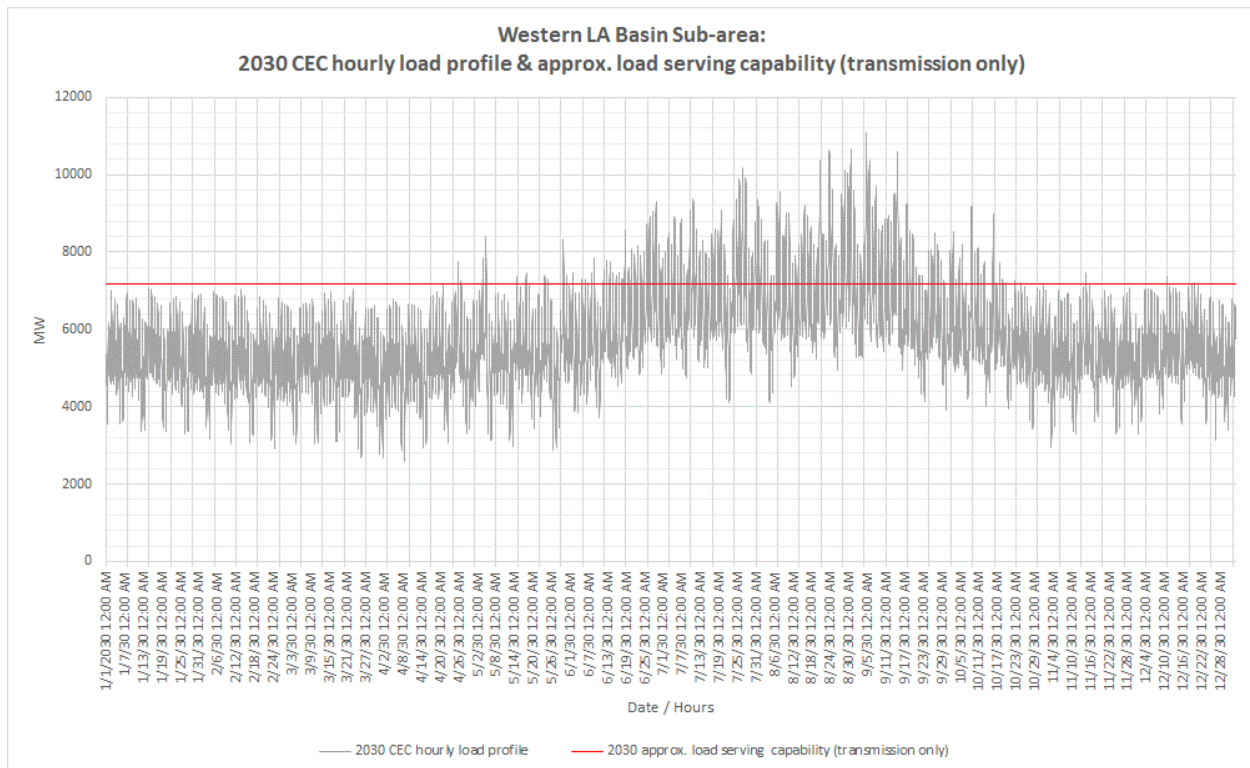
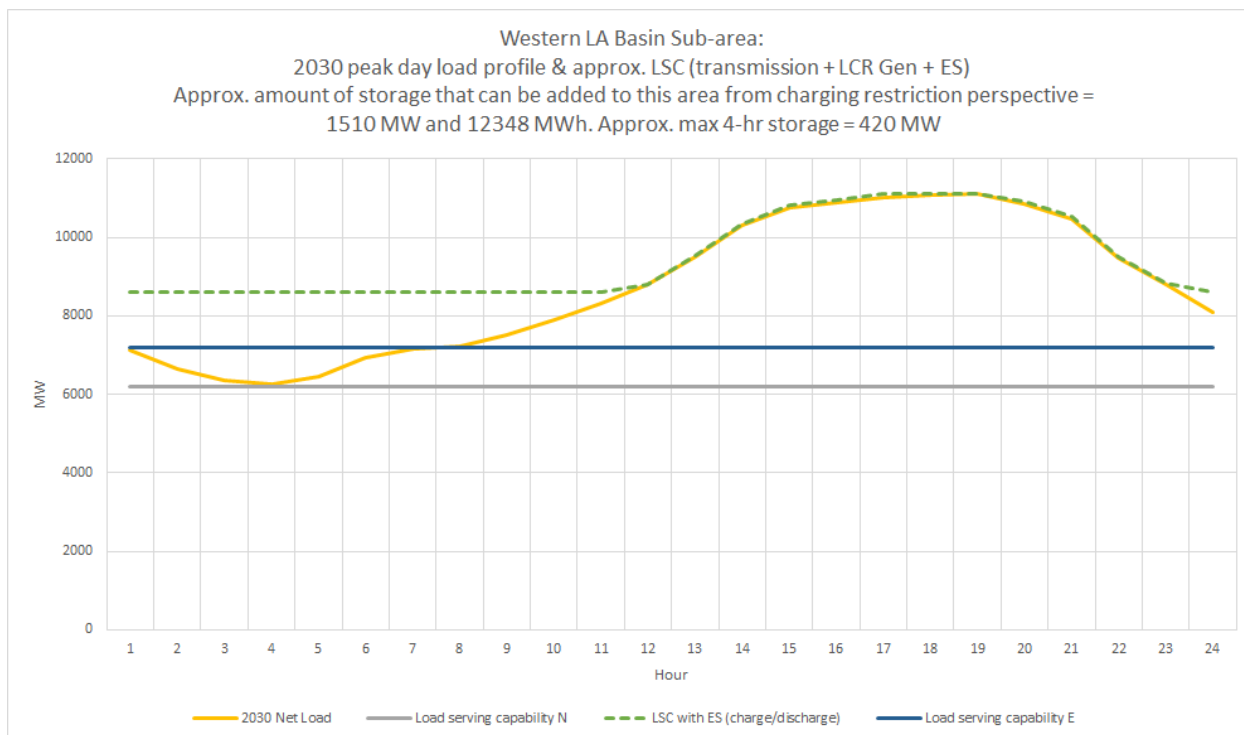

Figure 3.6-80 LCR Sub-area 2030 Estimated Amount of Storage that Can Be Added Based on Charging Restriction



3.6.9.3.4 Western LA Basin LCR Sub-area Requirement

Table 3.6-70 identifies the sub-area LCR requirements. The LCR requirement for Category P6 contingency is 3924 MW. The 2030 LCR need is lower than 2025 LCR need due to slightly lower load forecast for the western LA Basin sub-area.

Table 3.6-70 Western LA Basin LCR Sub-area Requirements

Year	Limit	Category	Limiting Facility	Contingency	LCR (MW) (Deficiency)
2030	First Limit	P6	Mesa-Laguna Bell 230 kV	Mesa-La Fresa 230 kV, followed by Mesa-Lighthipe 230 kV line or vice versa	3924

3.6.9.3.5 Effectiveness factors:

See Attachment B - Table titled [LA Basin](#).

For other helpful procurement information please read procedure 2210Z Effectiveness Factors under 7630 posted at: <http://www.caiso.com/Documents/2210Z.pdf>

There are other combinations of contingencies in the area that could overload a significant number of 230 kV lines in this sub-area have less LCR need. As such, anyone of them (combination of contingencies) could become binding for any given set of procured resources. As a result, these effectiveness factors may not be the best indicator towards informed procurement.

3.6.9.3.6 Alternatives to Reduce or Eliminate Gas Generation

In the 2020-2021 transmission planning process the Western LA Basin sub-area was not selected to assess alternatives to reduce or eliminate the requirement for gas-fired generation to address the LCR requirement.

As a part of the 2019-2020 transmission planning process the ISO undertook an assessment of the Western LA Basin sub-area in order to determine potential transmission alternatives to reduce or eliminate the need for gas-fired generation.

3.6.9.4 West of Devers Sub-area

West of Devers is a sub-area of the LA Basin LCR area.

There are no local capacity requirements due to implementation of the Mesa Loop-in as well as West of Devers reconductoring projects.

3.6.9.5 Valley-Devers Sub-area

Valley-Devers is a sub-area of the LA Basin LCR area.

There are no local capacity requirements due to implementation of the Colorado River-Delaney 500 kV line project.

3.6.9.6 Valley Sub-area

Valley is a sub-area of the LA Basin LCR area.

There are no local capacity requirements due to implementation of the Colorado River-Delaney 500 kV line project.

3.6.9.7 Eastern LA Basin Sub-area

Eastern LA Basin is a sub-area of the LA Basin LCR area.

3.6.9.7.1 Eastern LA Basin LCR Sub-area Diagram

Please refer to Figure 3.6-74 above.

3.6.9.7.2 Eastern LA Basin LCR Sub-area Load and Resources

Table 3.6-71 provides the forecast load and resources in Eastern LA Basin LCR sub-area in 2030. The list of generators within the LCR sub-area are provided in Attachment A.

Table 3.6-71 Eastern LA Basin Sub-area 2030 Forecast Load and Resources

Load (MW)		Generation (MW)	Aug NQC	At Peak
Gross Load	8854	Market, Net Seller, Battery, Wind	2384	2384
AAEE	-273	MUNI	472	472
Behind the meter DG	0	QF	83	83
Net Load	8181	LTPP Preferred Resources	0	0
Transmission Losses	160	Existing Demand Response	126	126
Pumps	20	Solar	9	0
Load + Losses + Pumps	8361	Total	3074	3065

3.6.9.7.3 Eastern LA Basin LCR Sub-area Hourly Profiles

Figure 3.6-81 illustrates the forecast 2030 profile for the summer peak day in the Eastern LA Basin LCR sub-area with the Category P1 normal and emergency load serving capabilities without local capacity resources.

Figure 3.6-82 and Figure 3.6-83 illustrate hourly load profiles with transmission only load serving capability and estimated amount of storage that can be added based on charging restriction. For this case, an estimated 1610 MW and 12142 MWh of energy storage can be accommodated from the charging limitation perspective as shown on Figure 3.6-83. The estimated amount of 4-hour energy storage is 475 MW.

Figure 3.6-81 Eastern LA Basin LCR Sub-area 2030 Peak Day Forecast Profiles

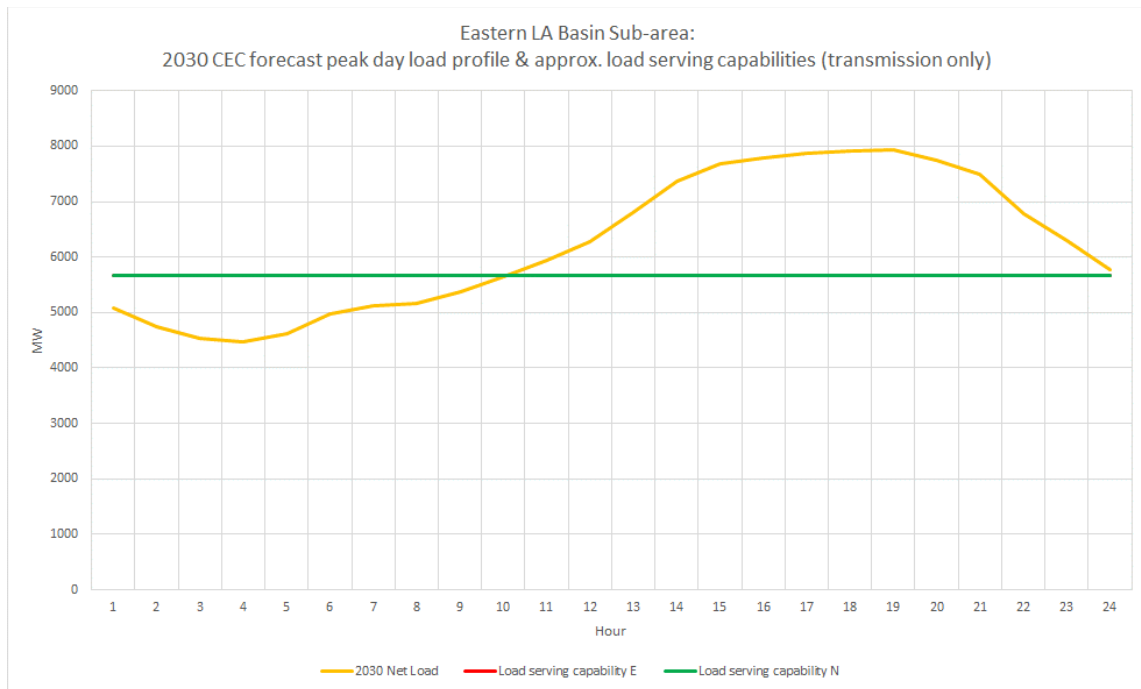

Figure 3.6-82 Eastern LA Basin LCR Sub-area 2030 Hourly Load Forecast Profiles with Transmission Only Load Serving Capability

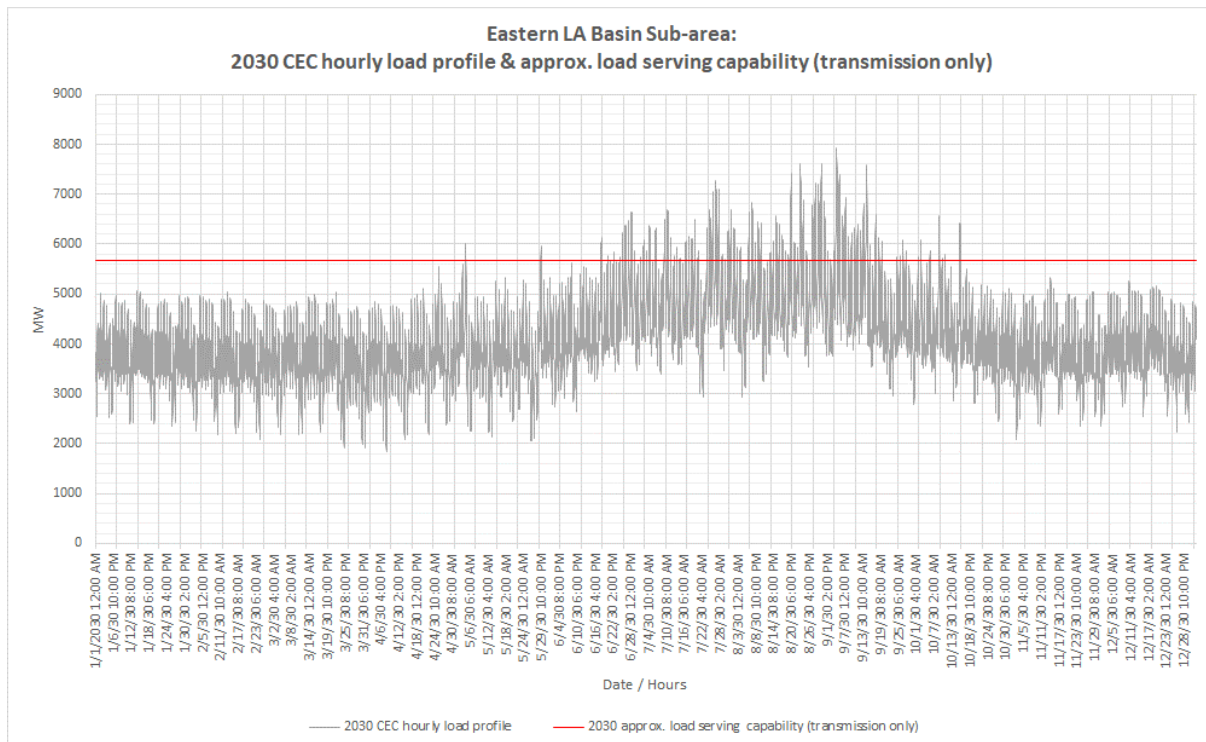
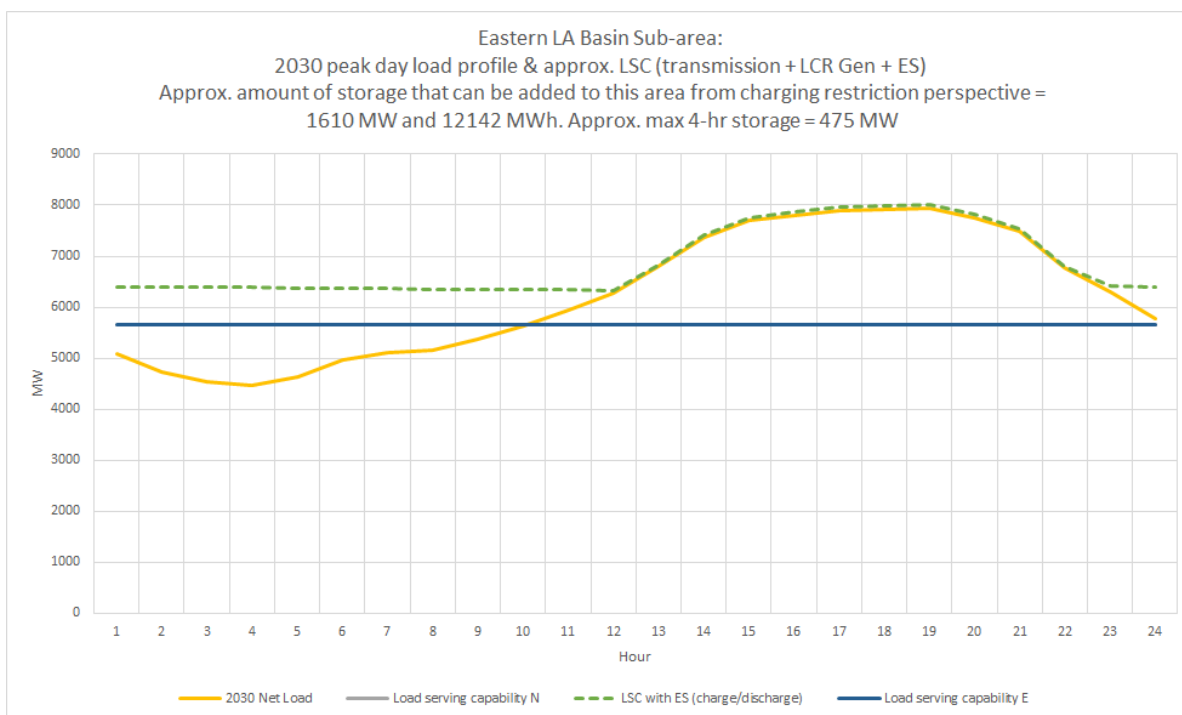

Figure 3.6-83 Eastern LCR Sub-area 2030 Estimated Amount of Storage that Can Be Added Based on Charging Restriction



3.6.9.7.4 Eastern LA Basin LCR Sub-area Requirement

Table 3.6-72 identifies the sub-area LCR requirements. The LCR requirement for Category P1+P7 contingency is 2270 MW. The 2030 LCR need for the Eastern LA Basin is lower than the 2025 local capacity need due to lower Path 49 and Path 46 flows into the ISO BA, mostly due to unavailability of solar resources near Colorado River during early evening peak load hours as well as less resources available from the Southwest during peak load hours. Lower path flows result in lower line voltage drop, which reduces the potential voltage stability concern under a critical overlapping P1 and P7 transmission contingency.

Table 3.6-72 Eastern LA Basin LCR Sub-area Requirements

Year	Limit	Category	Limiting Facility	Contingency	LCR (MW) (Deficiency)
2030	First Limit	P1+P7	Post transient voltage stability	Alberhill-Serrano 500 kV, followed by Devers-Red Bluff #1 and #2 500 kV	2270

3.6.9.7.5 Effectiveness factors:

All units within the Eastern LA Basin Sub-area have the same effectiveness factor.

For most helpful procurement information please read procedure 2210Z Effectiveness Factors under 7750 posted at: <http://www.caiso.com/Documents/2210Z.pdf>

3.6.9.7.6 Alternatives to Reduce or Eliminate Gas Generation

In the 2020-2021 transmission planning process the Eastern LA Basin sub-area was not selected to assess alternatives to reduce or eliminate the requirement for gas-fired generation to address the LCR requirement.

As a part of the 2018-2019 transmission planning process the ISO undertook an assessment of the Eastern LA Basin sub-area in order to determine potential transmission alternatives to reduce or eliminate the need for gas-fired generation.

3.6.9.8 LA Basin Overall

3.6.9.8.1 LA Basin LCR Sub-area Hourly Profiles

Figure 3.6-84 illustrates the forecast 2030 profile for the summer peak day in the overall LA Basin LCR area with the Category P1 normal and emergency load serving capabilities without local capacity resources.

Figure 3.6-85 and Figure 3.6-86 illustrate hourly load profiles with transmission only load serving capability and estimated amount of storage that can be added based on charging restriction. For this case, an estimated 3550 MW and 27244 MWh of energy storage can be accommodated from the charging limitation perspective as shown on Figure 3.6-86. The estimated amount of 4-hour energy storage is 1070 MW.

Figure 3.6-84 Overall LA Basin LCR area 2030 Peak Day Forecast Profiles

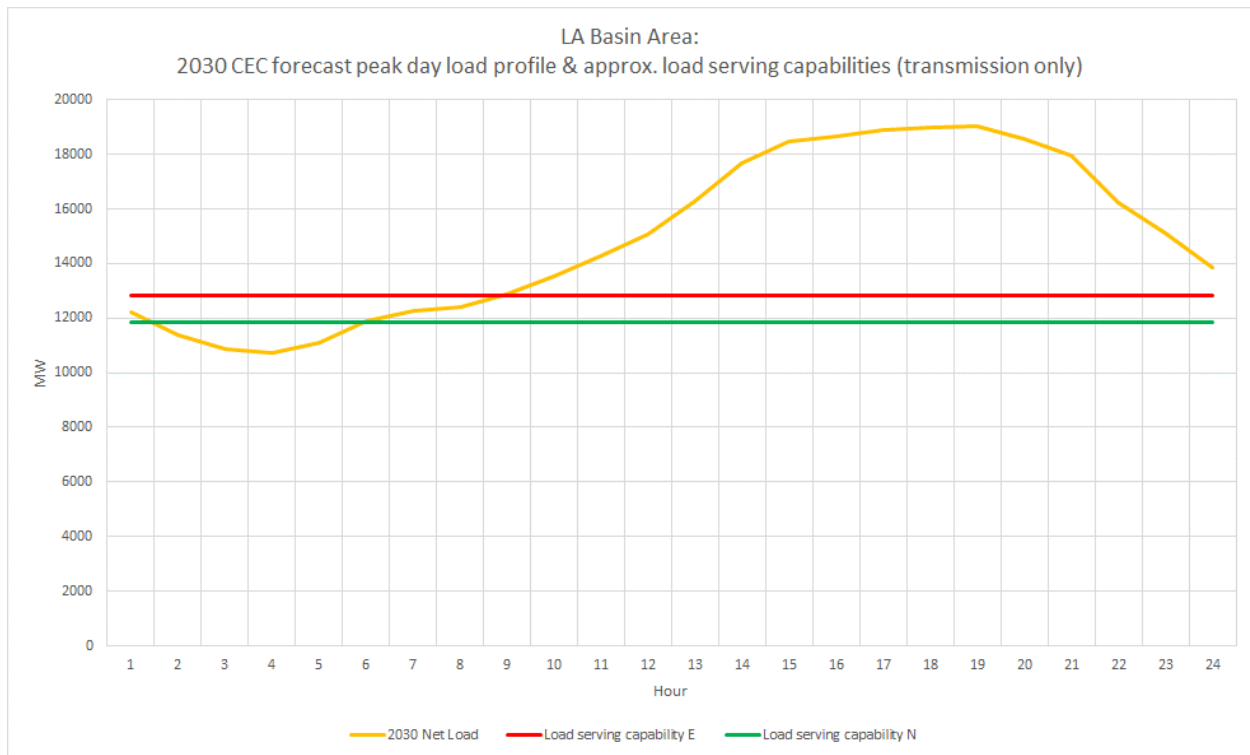

Figure 3.6-85 Overall LA Basin LCR area 2030 Hourly Load Forecast Profiles with Transmission Only Load Serving Capability

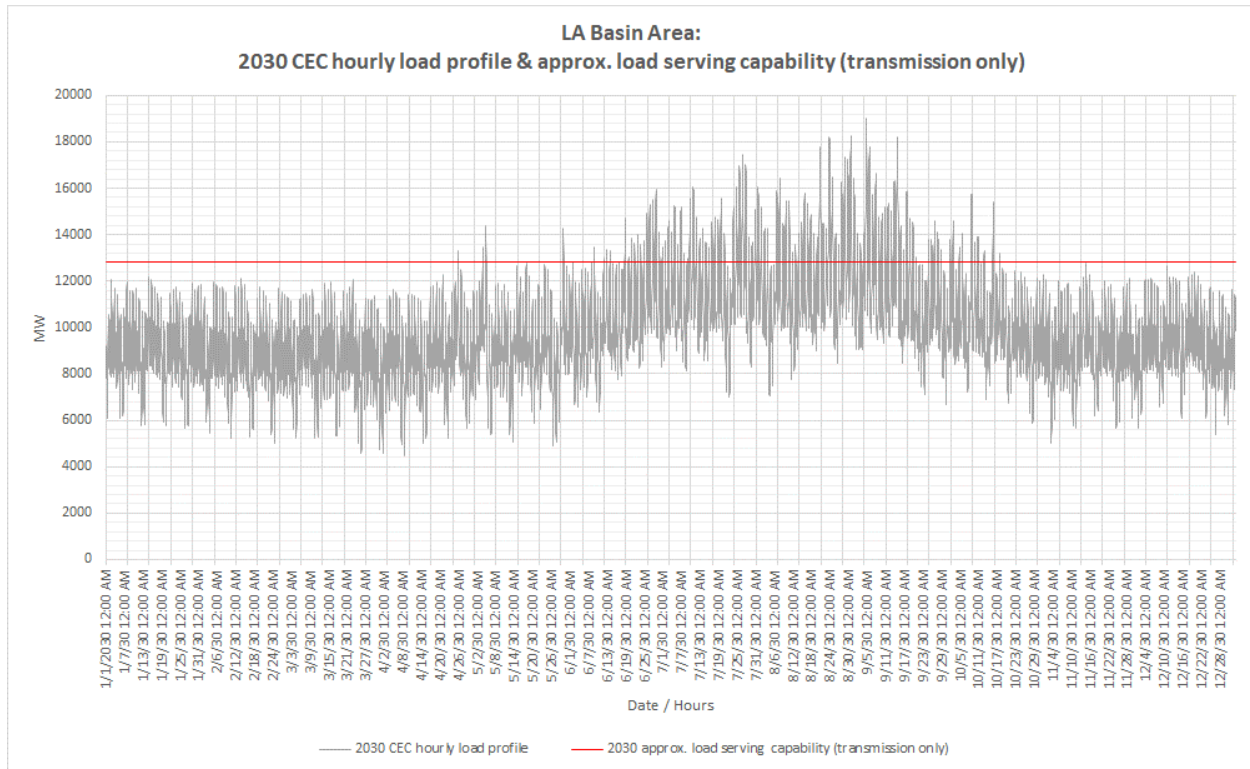
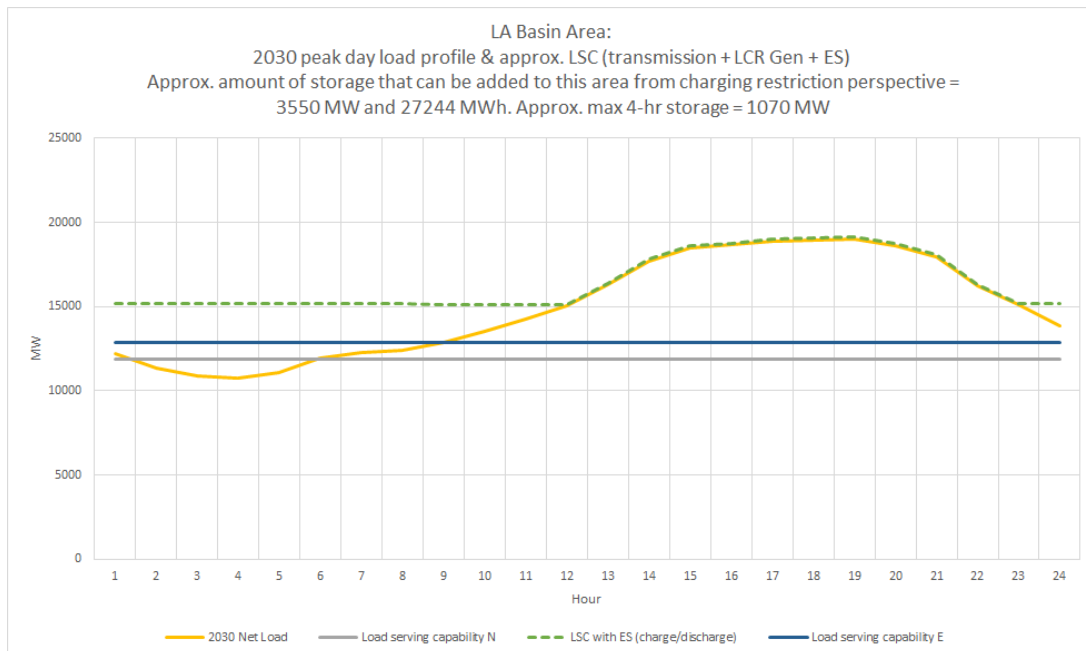

Figure 3.6-86 Overall LA Basin LCR Area 2030 Estimated Amount of Storage that Can Be Added Based on Charging Restriction



The following is a summary of estimated amount of storage for the sub-areas and the overall area based on maximum charging capability perspective. Due to non-linearity of power system and the various critical contingencies and load shapes for each sub-area and the overall area, it is noted that the estimated maximum amount of storage for the sub-areas many not add up to be sum of the overall area. The estimated maximum amount of storage for the LCR area is the amount listed in the last row in the table.

Table 3.6-73 Estimated LA Basin Sub-areas and Overall Area Energy Storage Capacity and Energy Based on Maximum Charging Capability Perspective

Area/Sub-area	Estimated Energy Storage Maximum Capacity (MW)	Estimated Energy Storage Maximum Energy (MWh)	Estimated Maximum 4-hour Energy Storage
El Nido sub-area	231	1587	91
Western LA Basin sub-area	1510	12348	420
Eastern LA Basin sub-area	1610	12142	475
Overall LA Basin area	3550	27244	1070

3.6.9.8.2 LA Basin LCR area Requirement

Table 3.6-74 identifies the area's LCR requirement. The LCR requirement is driven by the sum of the LCR needs for the Western LA Basin and Eastern LA Basin sub-areas, at 6194 MW. Additionally, the LCR need in the same amount is also caused by a Category P3 contingency of G-1 of TDM power plant, system readjustment, followed by an outage on the Imperial Valley – North Gila 500 kV line.

Table 3.6-74 LA Basin LCR area Requirements

Year	Limit	Category	Limiting Facility	Contingency	LCR (MW) (Deficiency)
2030	First Limit	N/A	Sum of Western and Eastern.		6194
2030	Second Limit	P3	El Centro 230/92 kV	TDM, system readjustment and Imperial Valley–North Gila 500 kV line	6194

3.6.9.8.3 Effectiveness factors:

See Attachment B - Table titled [LA Basin](#).

For other helpful procurement information please read procedure 2210Z Effectiveness Factors under 7550, 7570, 7580, 7590, 7590, 7680 and 7750 posted at: <http://www.caiso.com/Documents/2210Z.pdf>

There are other combinations of contingencies in the area that could overload a significant number of 230 kV lines in this sub-area have less LCR need. As such, anyone of them (combination of contingencies) could become binding for any given set of procured resources. As a result, these effectiveness factors may not be the best indicator towards informed procurement.

3.6.9.8.4 Changes compared to the 2025 LCT study

The load forecast is higher by 418 MW. The LCR need has decreased by 115 MW primarily due to lower LCR need in the Eastern LA Basin. Lower path flows result in lower line voltage drop, which reduces the potential voltage instability concern under a critical overlapping P1 and P7 transmission contingency during peak load condition.

3.6.9.8.5 Alternatives to Reduce or Eliminate Gas Generation

As a part of the 2018-2019 and 2019-2020 transmission planning process the ISO undertook an assessment of the LA Basin overall area in order to determine potential transmission alternatives to reduce or eliminate the need for gas-fired generation.

As a part of the 2020-2021 transmission planning process the following alternatives were considered.

- Upgrade La Fresa-La Cienega 230kV line and install series reactors on the Mesa-Laguna Bell and Mesa-Lighthipe 230kV lines;
- Pacific Transmission Expansion (PTE) Voltage-Source HVDC Project (two options for terminations in the LA Basin);
- Devers-Lighthipe HVDC line;
- Install a new Lugo area to LA Basin HVDC line with underground AC cable connections to Lighthipe and La Cienega Substations;
- Lake Elsinore Advanced Pumped Storage (LEAPS) Project with three options for terminations (i.e., (a) connections to both SCE and SDG&E via transmission lines only; (b) connection to both SCE and SDG&E with addition of pumped storage; and (c) connection to SDG&E only. For this alternative and its subsections, please see San Diego-Imperial Valley section (3.6.10) as the local capacity benefits were identified for this area.

Table 3.6-75 provides the LCR requirement for the alternatives identified above. The top four alternatives are included in the LA Basin section as these alternatives primarily benefit the LA Basin LCR area. The LEAPS alternatives are included in the write-up for San Diego-Imperial Valley area. For the alternatives that reduced the LCR requirement but did not eliminate the requirement, the limiting facility and contingency have been provided.

Table 3.6-75 Alternatives to Reduce or Eliminate the LA Basin Overall Area Requirement for Gas-fired generation

Year	Limit	Category	Limiting Facility	Contingency	LA Basin LCR (MW)	Notes
Upgrade La Fresa-La Cienega 230kV line and install series reactors on the Mesa-Laguna Bell and Mesa-Lighthipe 230kV lines						
2030	First Limit	P6	Mesa-Redondo #1 230 kV	Mesa-Laguna Bell #1 230 kV followed by Mesa-Lighthipe 230 kV or vice versa	5057	Increases San Diego-Imperial Valley LCR need 465 MW
Pacific Transmission Expansion Project – Option 1 (Diablo Canyon to Goleta, Redondo Beach and Huntington Beach)						
2030	First Limit	P6	Mesa-Laguna Bell #1 230 kV	Mesa-Redondo #1 230 kV followed by Mesa-Lighthipe 230 kV or vice versa	4454 ⁷	Increases San Diego-Imperial Valley LCR need by 140 MW
Pacific Transmission Expansion Project – Option 2 (Diablo Canyon to Goleta, El Segundo, Huntington Beach and San Onofre)						
2030	First Limit	P6	Mesa-Laguna Bell #1 230 kV	Mesa-Redondo #1 230 kV followed by Mesa-Lighthipe 230 kV or vice versa	5539	No negative impact to San Diego-IV LCR
Devers-Lighthipe HVDC Line						
2030	First Limit	P6	Mesa-Laguna Bell #1 230 kV	Mesa-Redondo #1 230 kV followed by Mesa-Lighthipe 230 kV or vice versa	5345	Negative impact to SD-IV LCR need (increased by 211 MW)
Lugo Areas – LA Basin HVDC Line with AC Connections to Lighthipe and La Cienega Substations						

⁷ This option assumes that an amount of 2,000 MW of replacement capacity will be injected to the proposed Diablo Canyon HVDC terminal for delivery to Southern California terminals.

Year	Limit	Category	Limiting Facility	Contingency	LA Basin LCR (MW)	Notes
2030	First Limit	P6	Mesa-Laguna Bell #1 230 kV	Mesa-Redondo #1 230 kV followed by Mesa-Lighthipe 230 kV or vice versa	5576	Negative impact to SD-IV LCR need (increased by 75 MW)

Table 3.6-76 provides the cost estimates and the total LA Basin overall area requirement and portion of requirement that would need to be supplied from gas-fired and non-gas generation for the alternatives identified above.

Table 3.6-76 Alternative Cost Estimate and LCR Requirement LA Basin Overall

Alternatives	Submitted By	Estimated Cost (\$M)	LA Basin LCR Requirement (MW)			
			Total	Market Gas	Other Gas	Non-Gas
Base case – No Alternative	N/A	0	6194	5300	100	794
Upgrade La Fresa-La Cienega 230 kV line and install 3 Ω line series reactor on the Mesa-Laguna Bell and Mesa-Lighthipe 230 kV lines	ISO	119	5057	4163	100	794
Pacific Transmission Expansion Project HVDC – Option 1	Western Grid Developer	1,850	4454	3560	100	794
Pacific Transmission Expansion Project HVDC – Option 2	Western Grid Developer	1,850	5539	4645	100	794
Devers-Lighthipe HVDC Line	ISO	1,100	5345	4451	100	794
Lugo Area – LA Basin HVDC Line with Underground AC Cable Connections to Lighthipe & La Cienega 230kV Substation	ISO	1,100	5576	4682	100	794

The LA Basin overall LCR need is limited by the requirements in the San Diego-Imperial Valley area as well as the requirements in the Eastern LA Basin and Western LA Basin. It is, therefore, that in addition to evaluate for positive LCR benefits (i.e., reduction of LCR need), additional study be performed to evaluate for potential negative impact to LCR need in adjacent areas.

The economic analysis of the local capacity reduction benefits is discussed further in details in Chapter 4.

3.6.10 San Diego-Imperial Valley Area

3.6.10.1 **Area Definition:**

The transmission tie lines forming a boundary around the Greater San Diego-Imperial Valley area include:

- Imperial Valley – North Gila 500 kV Line
- Otay Mesa – Tijuana 230 kV Line
- San Onofre - San Luis Rey #1 230 kV Line
- San Onofre - San Luis Rey #2 230 kV Line
- San Onofre - San Luis Rey #3 230 kV Line
- San Onofre – Talega 230 kV Line
- San Onofre – Capistrano 230 kV Line
- Imperial Valley – El Centro 230 kV Line
- Imperial Valley – La Rosita 230 kV Line

The substations that delineate the Greater San Diego-Imperial Valley area are:

- Imperial Valley is in North Gila is out
- Otay Mesa is in Tijuana is out
- San Onofre is out San Luis Rey is in
- San Onofre is out San Luis Rey is in
- San Onofre is out San Luis Rey is in
- San Onofre is out Talega is in
- San Onofre is out Capistrano is in
- Imperial Valley is in El Centro is out
- Imperial Valley is in La Rosita is out

3.6.10.1.1 San Diego-Imperial Valley LCR Area Diagram

Figure 3.6-87 San Diego-Imperial Valley LCR Area

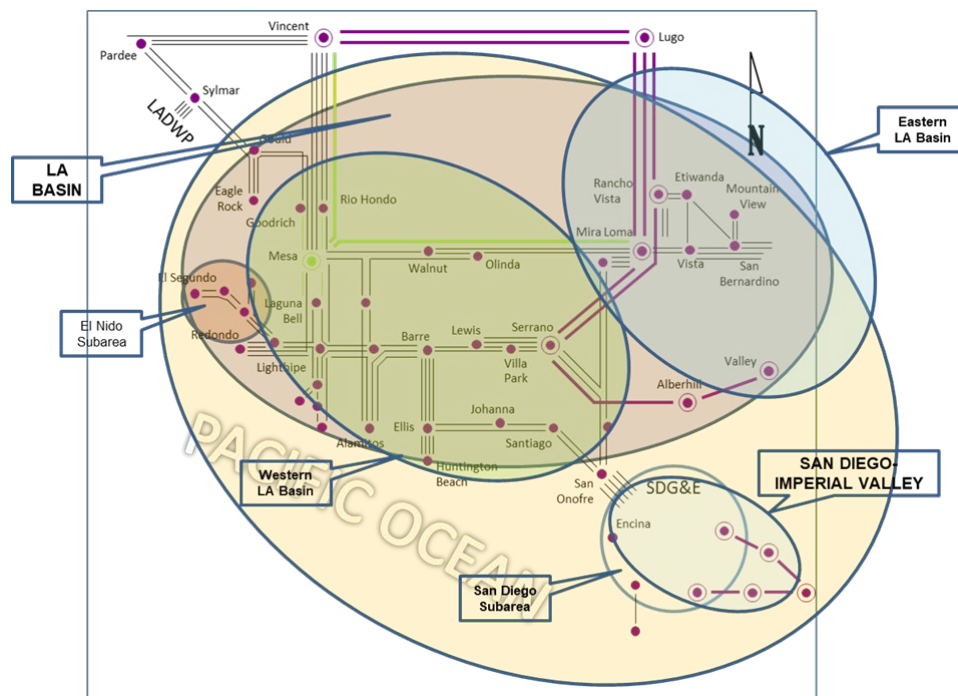

3.6.10.1.2 San Diego-Imperial Valley LCR Area Load and Resources

Table 3.6-77 provides the forecast load and resources in the San Diego-Imperial Valley LCR area in 2030. The list of generators within the San Diego-Imperial Valley area are provided in Attachment A.

In year 2030 the estimated time of local area peak is HE 8:00 P.M. (PDT) on September 4, 2030 per the CEC hourly demand forecast.⁸

At the local area peak time the estimated, ISO metered solar output is 0.00%.

If required, all non-solar technology type resources are dispatched at NQC.

Table 3.6-77 San Diego-Imperial Valley LCR Area 2030 Forecast Load and Resources

Load (MW)		Generation (MW)	Aug NQC	At Peak
Gross Load	4857	Market, Net Seller, Battery, Wind	4431	4431
AAEE	-108	Solar	378	0
Behind the meter DG	0	QF	2	2

⁸ https://ww2.energy.ca.gov/2019_energy/policy/documents/Demand_2020-2030_revised_forecast_hourly.php (the CEC forecast is based on PST throughout the year)

Net Load	4749	LTPP Preferred Resources	0	0
Transmission Losses	108	Existing Demand Response	7	7
Pumps	0	Mothballed	0	0
Load + Losses + Pumps	4857	Total	4818	4440

3.6.10.1.3 Approved transmission projects modeled:

Ocean Ranch 69 kV substation

Mesa Height TL600 Loop-in

Re-conductor of Kearny-Mission 69 kV line

TL6906 Mesa Rim rearrangement

Re-conductor of Japanese Mesa–Basilone–Talega Tap 69 kV lines

By-passing 500 kV series capacitor banks on the Southwest Powerlink and Sunrise Powerlink lines

Battery energy storage projects (total of 389 MW/615 MWh) at various locations

TL632 Granite loop-in and TL6914 reconfiguration

2nd San Marcos–Escondido 69 kV line

Reconductor of Stuart Tap–Las Pulgas 69 kV line (TL690E)

2nd Poway–Pomerado 69 kV line

Artesian 230 kV expansion with 69 kV upgrade

Kearny – Clairemont Tap (TL600) Reconductor and Loop into Mesa Heights

Reconductor TL605 Silvergate – Urban

Open Sweetwater Tap (TL603) and Loop into Sweetwater

South Orange County Reliability Enhancement

Imperial Valley-El Centro 230 kV (“S”) line upgrade

3.6.10.2 *El Cajon Sub-area*

El Cajon sub-area will be eliminated due to the TL632 Granite loop-in and TL6914 reconfiguration project and change in LCR criteria.

3.6.10.3 *Mission Sub-area*

Mission sub-area has been eliminated due to the TL600 Mesa Heights 69 kV Loop-in and the TL676 Mission-Mesa Heights 69 kV Reconducting projects being in-service.

3.6.10.4 **Esco Sub-area**

Esco sub-area has been eliminated due to change in LCR criteria.

3.6.10.5 **Pala Inner Sub-area**

Pala Inner sub-area has been eliminated due to change in LCR criteria.

3.6.10.6 **Pala Outer Sub-area**

Pala Outer sub-area has been eliminated due to change in LCR criteria.

3.6.10.7 **Border Sub-area**

Border is Sub-area of the San Diego-Imperial Valley LCR Area.

3.6.10.7.1 **Border LCR Sub-area Diagram**

Figure 3.6-88 Border LCR Sub-area

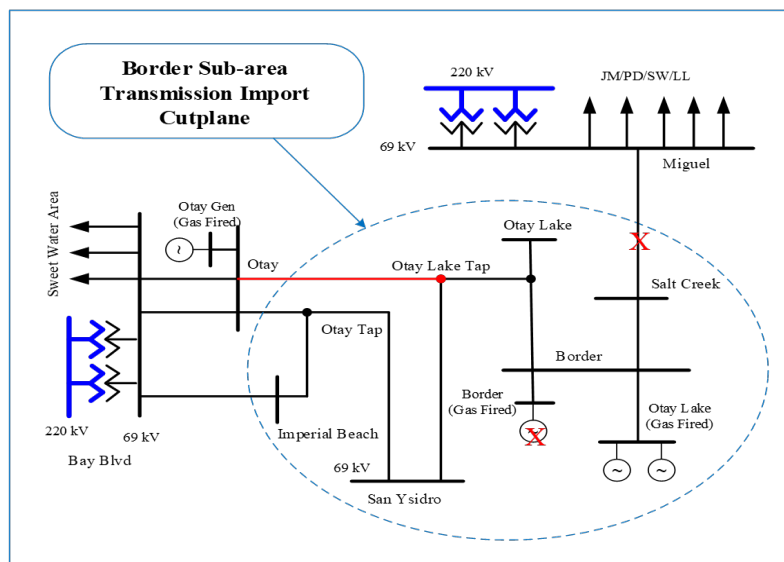

3.6.10.7.2 **Border LCR Sub-area Load and Resources**

Table 3.6-78 provides the forecast load and resources in Border LCR sub-area in 2030. The list of generators within the LCR sub-area are provided in Attachment A.

Table 3.6-78 Border Sub-area 2030 Forecast Load and Resources

Load (MW)		Generation (MW)	Aug NQC	At Peak
Gross Load	173	Market, Net Seller, Battery	143	143
AAEE	-3	Solar	0	0
Behind the meter DG	0	QF	0	0

Net Load	167	LTPP Preferred Resources	0	0
Transmission Losses	3	Demand Response	0	0
Pumps	0	Mothballed	0	0
Load + Losses + Pumps	170	Total	143	143

3.6.10.7.3 Border LCR Sub-area Hourly Profiles

Figure 3.6-89 illustrates the 2030 annual load forecast profile in the Border LCR sub-area and the Category P1 (L-1 Contingency) transmission capability without local capacity generation. Figure 3.6-90 illustrates the 2030 daily load forecast profile for the peak day in the sub-area along with the load serving capabilities. The illustration also includes an estimate of 31/185 MW/MWh energy storage that could be added in this local area from charging restriction perspective. In addition, it is estimated that up to 16 MW of 4-hour energy storage could be installed to displace 1 for 1 MW of gas generation in the Border LCR sub-area.

Figure 3.6-89 Border LCR Sub-area 2030 Annual Load Forecast Profiles

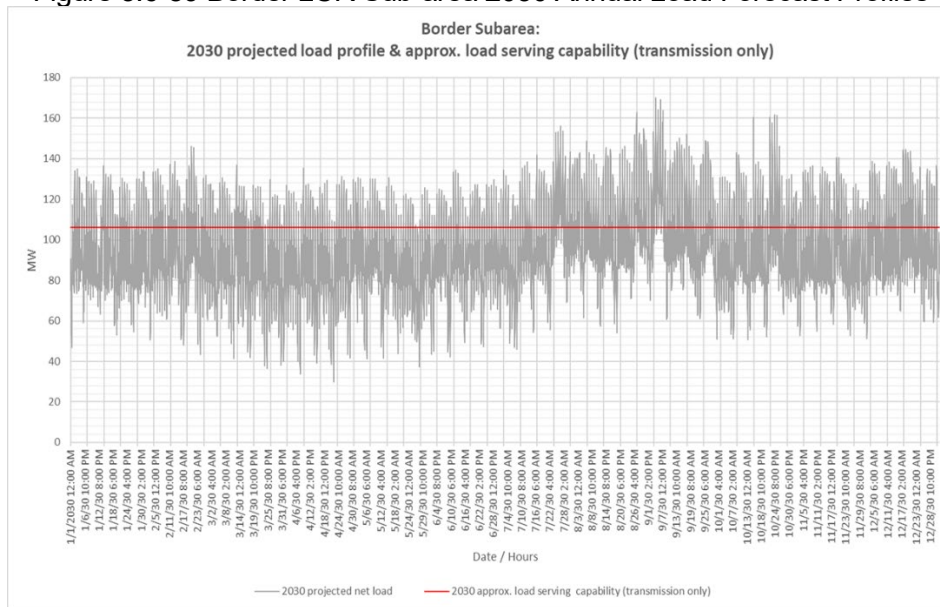
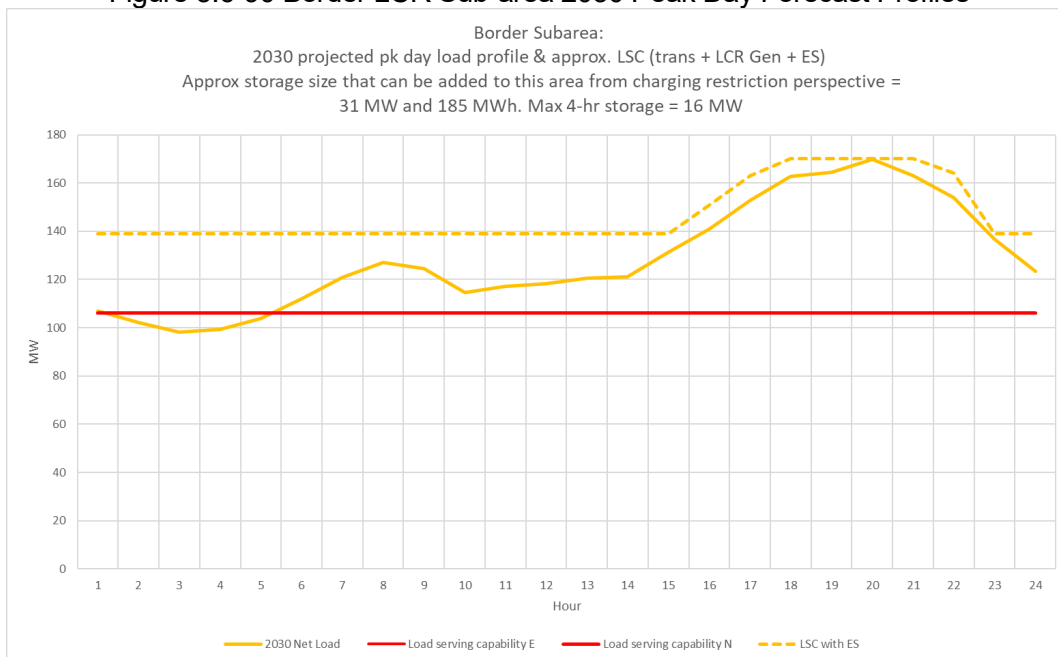

Figure 3.6-90 Border LCR Sub-area 2030 Peak Day Forecast Profiles



3.6.10.7.4 Border LCR Sub-area Requirement

Table 3.2-80 identifies the sub-area requirements. The LCR requirement for Category P3 contingency is 93 MW.

Table 3.6-79 Border 2030 LCR Sub-area Requirements

Year	Category	Limiting Facility	Contingency	LCR (MW) (Deficiency)
2030	P3	Otay – Otay Lake Tap 69 kV (TL649)	Border unit out of service followed by the outage of Miguel-Salt Creek 69 kV #1	93

3.6.10.7.5 Effectiveness factors:

All units within the Border Sub-area have the same effectiveness factor.

3.6.10.7.6 Alternatives to Reduce or Eliminate Gas Generation

As a part of the 2018-2019 transmission planning process the ISO undertook an assessment of the Border sub-area in order to determine potential transmission alternatives to reduce or eliminate the need for gas-fired generation.

As a part of the 2020-2021 transmission planning process the following transmission alternative was assessed.

- Upgrade Otay-Otay Lake Tap 69 kV.

The transmission alternative will fully eliminate the LCR requirement. The cost estimate of the alternative needs to be determined.

3.6.10.8 **Miramar Sub-area**

Miramar sub-area has been eliminated due to the Sycamore-Penasquitos 230 kV project being in-service.

3.6.10.9 **San Diego Sub-area**

San Diego is a sub-area of the San Diego-Imperial Valley LCR area.

3.6.10.9.1 San Diego LCR Sub-area Diagram

Please refer to Figure 3.6-87 above.

3.6.10.9.2 San Diego LCR Sub-area Load and Resources

Table 3.6-80 provides the forecast load and resources in San Diego LCR sub-area in 2030. The list of generators within the LCR sub-area are provided in Attachment A.

Table 3.6-80 San Diego Sub-area 2030 Forecast Load and Resources

Load (MW)		Generation (MW)	Aug NQC	At Peak
Gross Load	4857	Market, Net Seller, Battery, Wind	2987	2987
AAEE	-108	Solar	29	0
Behind the meter DG	0	QF	2	2
Net Load	4749	LTPP Preferred Resources	0	0
Transmission Losses	108	Existing Demand Response	7	7
Pumps	0	Mothballed	0	0
Load + Losses + Pumps	4857	Total	3025	2996

3.6.10.9.3 San Diego LCR Sub-area Hourly Profiles

Figure 3-92 illustrates the forecast 2030 profile for the summer peak day in the San Diego LCR sub-area with the Category P1 normal and emergency load serving capabilities without local capacity resources.

Figure 3-93 and Figure 3-94 illustrate hourly load profiles with transmission only load serving capability and estimated amount of storage that can be added based on charging restriction. For this case, an estimated 1187 MW and 6973 MWh of energy storage can be accommodated from the charging limitation perspective as shown on Figure 3-94. The estimated amount of 4-hour energy storage is 680 MW.

Figure 3.2-91 San Diego LCR Sub-area 2030 Peak Day Forecast Profiles

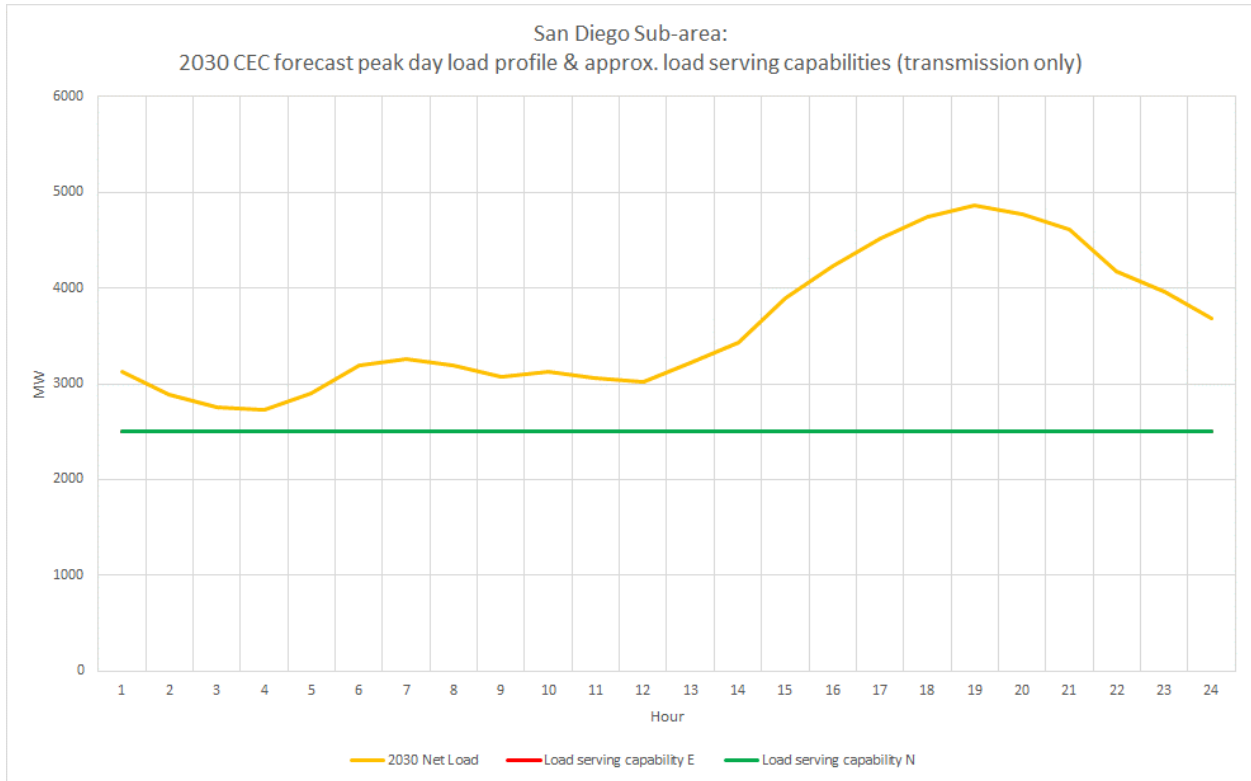

Figure 3-92 San Diego LCR sub-area 2030 Hourly Load Forecast Profiles with Transmission Only Load Serving Capability

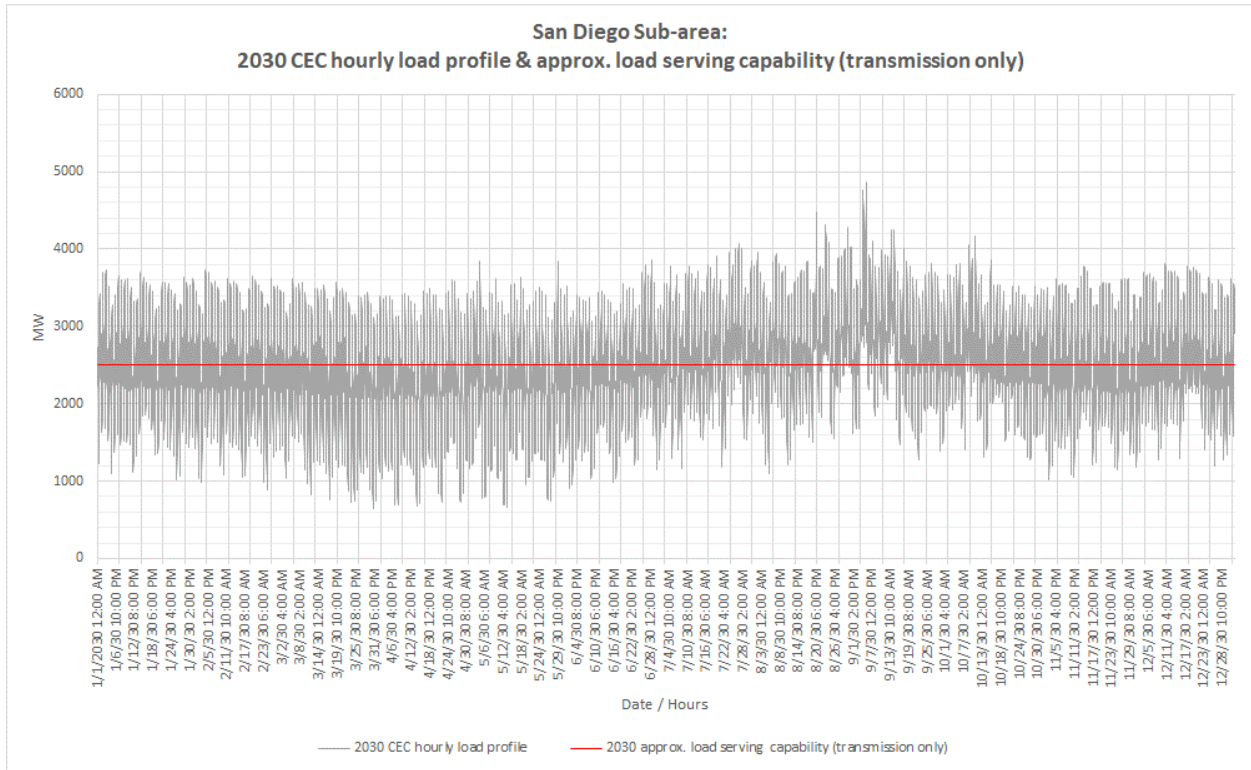
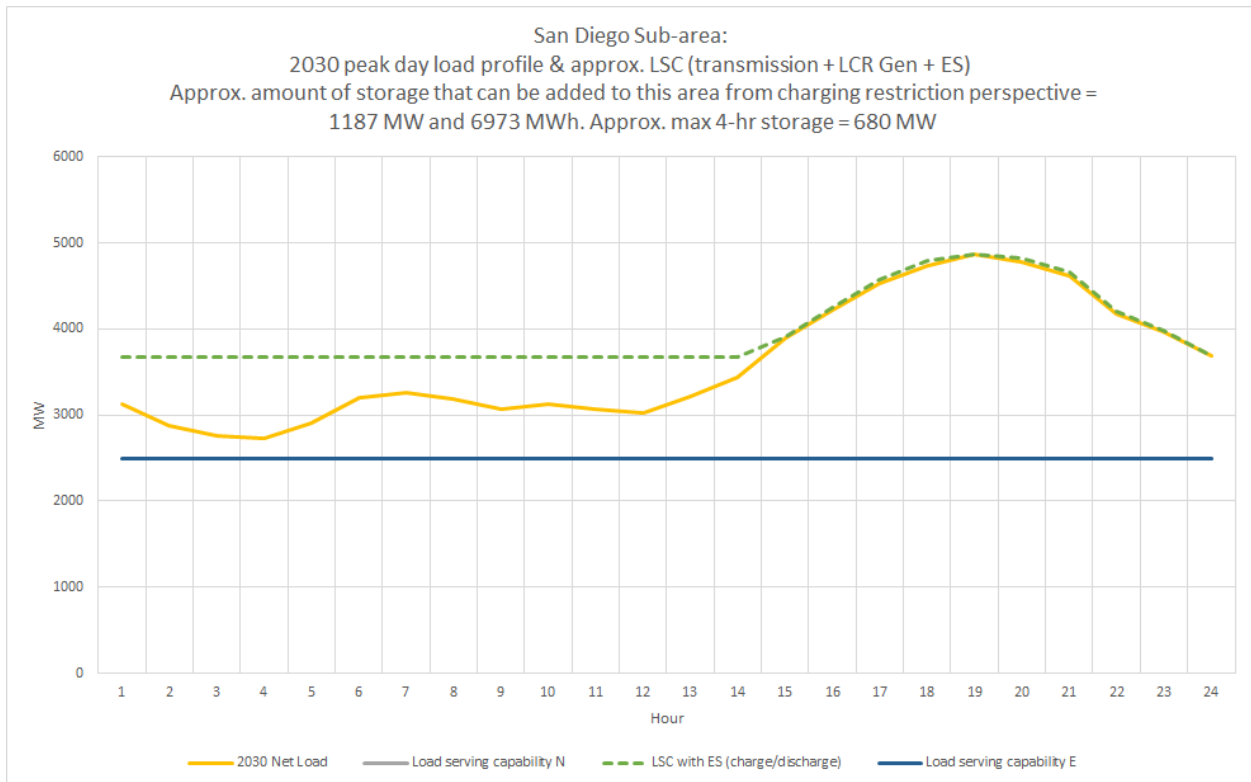

Figure 3-93 San Diego LCR Sub-area 2030 Estimated Amount of Storage that Can Be Added Based on Charging Restriction



3.6.10.9.4 San Diego LCR Sub-area Requirement

Table 3.6-81 identifies the sub-area LCR requirements. The LCR requirement for Category P6 contingency is 2842 MW.

Table 3.6-81 San Diego LCR Sub-area Requirements

Year	Limit	Category	Limiting Facility	Contingency	LCR (MW) (Deficiency)
2030	First Limit	P6	Remaining Sycamore – Suncrest 230 kV	Eco – Miguel 500 kV, system readjustment followed by one of the Sycamore – Suncrest 230 kV lines	2842

3.6.10.9.5 Effectiveness factors:

See Attachment B - Table titled [San Diego](#).

For other helpful procurement information please read procedure 2210Z Effectiveness Factors under 7820 posted at: <http://www.aiso.com/Documents/2210Z.pdf>

3.6.10.9.6 Alternatives to Reduce or Eliminate Gas Generation

In the 2020-2021 transmission planning process the San Diego sub-area was not selected to assess alternatives to reduce or eliminate the requirement for gas-fired generation to address the LCR requirement.

As a part of the 2018-2019 transmission planning process the ISO undertook an assessment of the San Diego sub-area in order to determine potential transmission alternatives to reduce or eliminate the need for gas-fired generation.

3.6.10.10 *San Diego-Imperial Valley Overall*

3.6.10.10.1 San Diego-Imperial Valley LCR area Hourly Profiles

Since the San Diego sub-area has all the substation loads, the overall San Diego-Imperial Valley area has the same load profile as the San Diego bulk sub-area. The Imperial Valley area has generating resources. Figure 3.6-94 illustrates the forecast 2030 profile for the summer peak day in the San Diego-Imperial Valley LCR area with the Category P1 normal and emergency load serving capabilities without local capacity resources.

Figure 3.6-95 and Figure 3.6-96 illustrate hourly load profiles with transmission only load serving capability and estimated amount of storage that can be added based on charging restriction. For this case, an estimated 1187 MW and 6973 MWh of energy storage can be accommodated from the charging limitation perspective as shown on Figure 3.6-96. The estimated amount of 4-hour energy storage is 680 MW.

Figure 3.6-94 San Diego-Imperial Valley area 2030 Peak Day Forecast Profiles and Load Serving Capability Without Local Gas Generation

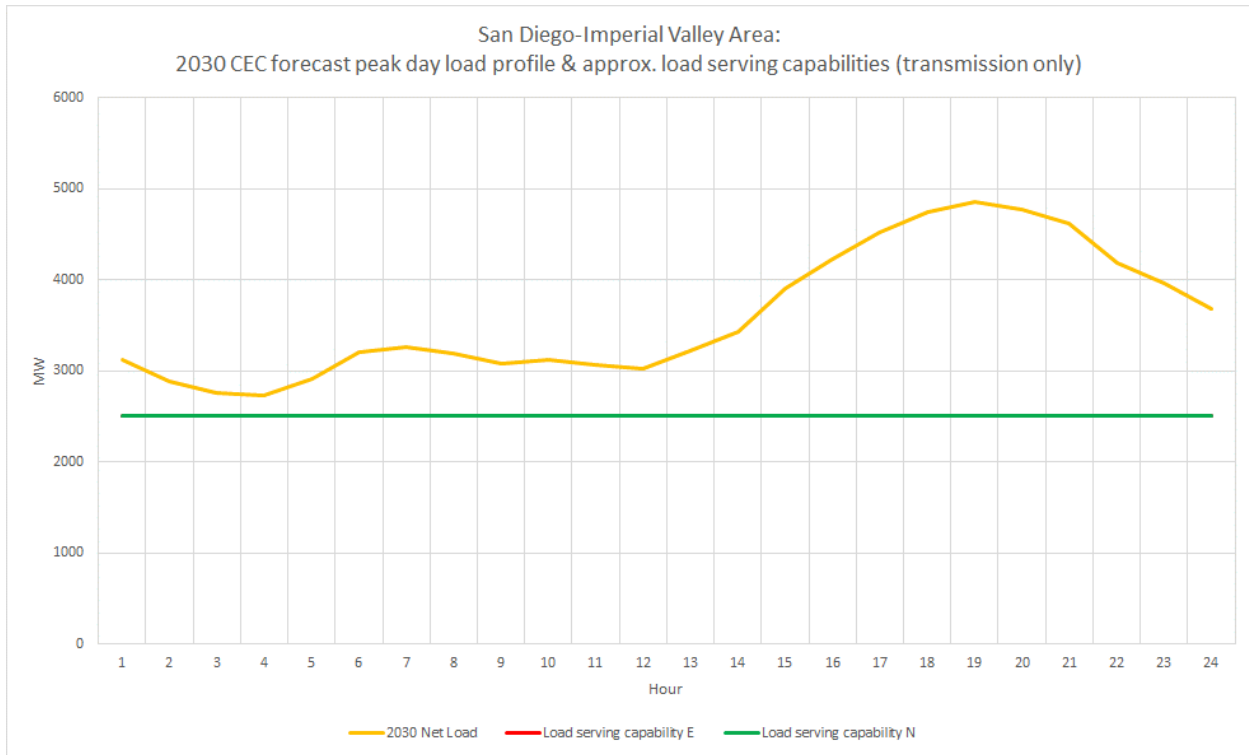

Figure 3.6-95 San Diego-Imperial Valley Area 2030 Hourly Load Forecast Profiles with Transmission Only Load Serving Capability

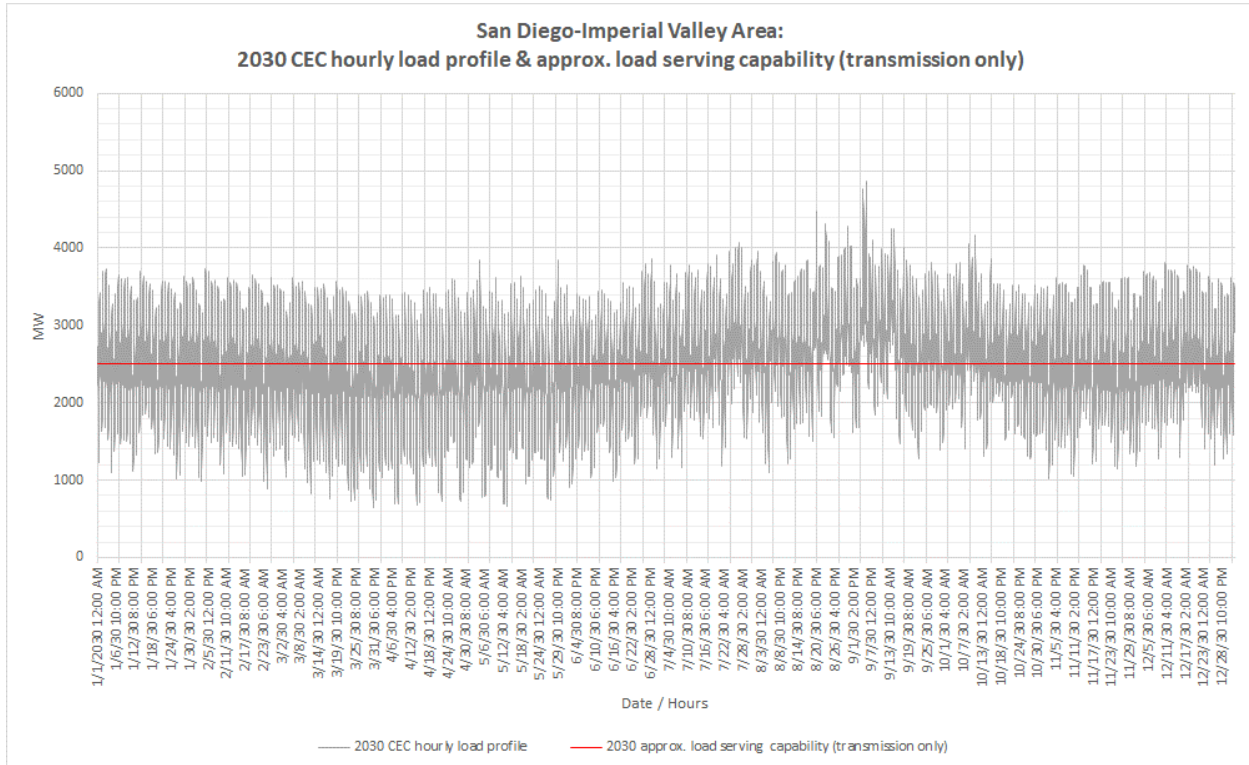
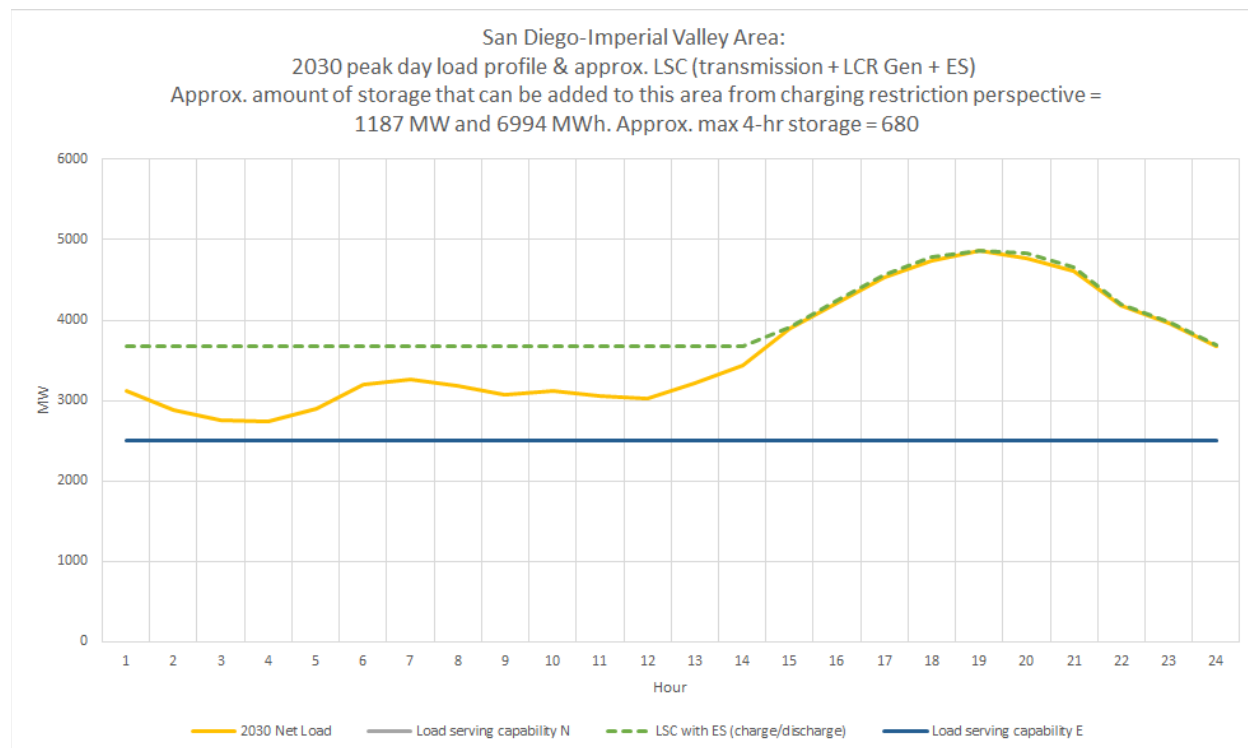

Figure 3.6-96 San Diego-Imperial Valley LCR Area 2030 Estimated Amount of Storage that Can Be Added Based on Charging Restriction



The following is a summary of estimated amount of storage for the sub-areas and the overall area based on maximum charging capability perspective. Due to non-linearity of power system and the various critical contingencies and load shapes for each sub-area and the overall area, it is noted that the estimated maximum amount of storage for the sub-areas many not add up to be sum of the overall area. Since the San Diego sub-area has all the substation loads, the overall San Diego-Imperial Valley area has the same load profile as the San Diego bulk sub-area and therefore same amount of energy storage for the San Diego sub-area. The Imperial Valley area (of the overall San Deigo-Imperial Valley) has generating resources only. The estimated maximum amount of storage for the LCR area is the amount listed in the last row in the table.

Table 3.6-82 Estimated San Diego Sub-areas and Overall Area Energy Storage Capacity and Energy Based on Maximum Charging Capability Perspective

Area/Sub-area	Estimated Energy Storage Maximum Capacity (MW)	Estimated Energy Storage Maximum Energy (MWh)	Estimated 4-Hour Energy Storage (MW)
Border sub-area	31	185	16
San Diego bulk sub-area	1187	6973	680
Overall San Diego-Imperial Valley area	1187	6994	680

3.6.10.10.2 San Diego-Imperial Valley LCR area Requirement

Table 3.6-83 identifies the area LCR requirements. The LCR requirement for Category P3 contingency is 3718 MW.

Table 3.6-83 San Diego-Imperial Valley LCR area Requirements

Year	Limit	Category	Limiting Facility	Contingency	LCR (MW) (Deficiency)
2030	First Limit	P3	El Centro 230/92 kV	TDM power plant, system readjustment and Imperial Valley–North Gila 500 kV line	3718

3.6.10.10.3 Effectiveness factors:

See Attachment B - Table titled [San Diego](#).

For other helpful procurement information please read procedure 2210Z Effectiveness Factors under 7820 posted at: <http://www.caiso.com/Documents/2210Z.pdf>

3.6.10.10.4 Changes compared to the 2025 LCT study

The demand forecast is higher by 182 MW. The overall LCR need for the San Diego – Imperial Valley area is increased by 161 MW, due to increase in load forecast.

3.6.10.10.5 Alternatives to Reduce or Eliminate Gas Generation

As a part of the 2018-2019 transmission planning process the ISO undertook an assessment of the San Diego-Imperial Valley area in order to determine potential transmission alternatives to reduce or eliminate the need for gas-fired generation.

As a part of the 2020-2021 transmission planning process the following transmission alternatives⁹ were considered:

1. Upgrade La Fresa-La Cienega 230kV line and install series reactors on the Mesa-Laguna Bell and Mesa-Lighthipe 230kV lines;
2. Pacific Transmission Expansion (PTE) Voltage-Source HVDC Project (two options for terminations in the LA Basin);
3. Devers-Lighthipe HVDC line;
4. Victorville-Century HVDC line with underground AC cable connections to Lighthipe and La Cienega Substations;
5. Lake Elsinore Advanced Pumped Storage (LEAPS) Project with three options for terminations (i.e., (a) connections to both SCE and SDG&E via transmission lines only;

⁹ Please see Chapter 4 for further details on power flow and economic evaluation for these alternatives.

(b) connection to both SCE and SDG&E with addition of pumped storage; and (c) connection to SDG&E only.

The first four alternatives are discussed in the LA Basin section as those alternatives provide gas-fired generation reduction benefits primarily to the LA Basin. The fifth alternative (LEAPS) is evaluated in the San Diego-Imperial Valley section as these alternatives primarily provide benefit to this area.

Table 3.6-84 provides the LCR requirement for the alternatives identified above. For the alternatives that reduced the LCR requirement but did not eliminate the requirement, the limiting facility and contingency have been provided.

Chapter 4 provides further details on the economic evaluation for the proposed transmission and transmission/storage alternatives for the local capacity requirement areas.

Table 3.6-84 Alternatives to Reduce or Eliminate the San Diego-Imperial Valley Area Requirement for Gas-fired generation

Year	Limit	Category	Limiting Facility	Contingency	LCR Need (MW)	Notes
Lake Elsinore Advanced Pumped Storage – Alternative 1A (Transmission Only)						
2030	First Limit	P3	TDM generation, system readjustment, followed by Imperial Valley-North Gila 500 kV line	Yucca-Pilot Knob 161 kV line	3275	Positive impact to SD-IV LCR need (reduced by 443 MW)
Lake Elsinore Advanced Pumped Storage – Alternative 1B (Transmission + 500 MW Pumped Storage)						
2030	First Limit	P3	TDM generation, system readjustment, followed by Imperial Valley-North Gila 500 kV line	Yucca-Pilot Knob 161 kV line	3204	Positive impact to SD-IV LCR need (reduced by 514 MW)
Lake Elsinore Advanced Pumped Storage – Alternative 2 (Transmission + 500 MW Pumped Storage; Connection to SDG&E Only)						
2030	First Limit	P3	TDM generation, system readjustment, followed by Imperial Valley-North Gila 500 kV line	Yucca-Pilot Knob 161 kV line	3185	Positive impact to SD-IV LCR need (reduced by 533 MW)

Table 3.6-85 provides the cost estimates and the total San Diego-Imperial Valley LCR area requirement and portion of requirement that would need to be supplied from gas-fired and non-gas generation for the alternatives identified above

Table 3.6-85 Alternative Cost Estimate and LCR Requirement

Alternatives	Submitted By	Estimated Cost (\$M)	LCR Requirement (MW)		
			Total	Market Gas Decrease (SD-IV)	LCR Increase (LA Basin)
LEAPS (Lake Elsinore Advanced Pump Storage) Option 1A (transmission only)	Nevada Hydro	\$829	3275	443	150
LEAPS (Lake Elsinore Advanced Pump Storage) Option 1B (transmission plus pumped storage)	Nevada Hydro	\$2,040	3204	514	0
LEAPS (Lake Elsinore Advanced Pump Storage) Option 2 (transmission plus pumped storage, connecting to SDG&E only)	Nevada Hydro	\$1,760	3185	533	0

3.6.11 Valley Electric Area

Valley Electric Association LCR area has been eliminated on the basis of the following:

- No generation exists in this area
- No category B issues were observed in this area
- Category C and beyond –
 - No common-mode N-2 issues were observed
 - No issues were observed for category B outage followed by a common-mode N-2 outage
 - All the N-1-1 issues that were observed can either be mitigated by the existing UVLS or by an operating procedure

Attachment A – List of physical resources by PTO, local area and market ID

PTO	MKT/SCHED RESOURCE ID	BUS #	BUS NAME	kV	NQC	UNIT ID	LCR AREA NAME	LCR SUB-AREA NAME	NQC Comments	CAISO Tag
PG&E	ALMEGT_1_UNIT 1	38118	ALMDACT1	13.8	23.40	1	Bay Area	Oakland		MUNI
PG&E	ALMEGT_1_UNIT 2	38119	ALMDACT2	13.8	23.50	1	Bay Area	Oakland		MUNI
PG&E	BANKPP_2_NSPIN	38820	DELTA A	13.2	11.55	1	Bay Area	Contra Costa	Pumps	MUNI
PG&E	BANKPP_2_NSPIN	38820	DELTA A	13.2	11.55	2	Bay Area	Contra Costa	Pumps	MUNI
PG&E	BANKPP_2_NSPIN	38820	DELTA A	13.2	11.55	3	Bay Area	Contra Costa	Pumps	MUNI
PG&E	BANKPP_2_NSPIN	38815	DELTA B	13.2	11.55	4	Bay Area	Contra Costa	Pumps	MUNI
PG&E	BANKPP_2_NSPIN	38815	DELTA B	13.2	11.55	5	Bay Area	Contra Costa	Pumps	MUNI
PG&E	BANKPP_2_NSPIN	38770	DELTA C	13.2	11.55	6	Bay Area	Contra Costa	Pumps	MUNI
PG&E	BANKPP_2_NSPIN	38770	DELTA C	13.2	11.55	7	Bay Area	Contra Costa	Pumps	MUNI
PG&E	BANKPP_2_NSPIN	38765	DELTA D	13.2	11.55	8	Bay Area	Contra Costa	Pumps	MUNI
PG&E	BANKPP_2_NSPIN	38765	DELTA D	13.2	11.55	9	Bay Area	Contra Costa	Pumps	MUNI
PG&E	BANKPP_2_NSPIN	38760	DELTA E	13.2	11.55	10	Bay Area	Contra Costa	Pumps	MUNI
PG&E	BANKPP_2_NSPIN	38760	DELTA E	13.2	11.55	11	Bay Area	Contra Costa	Pumps	MUNI
PG&E	BRDSL_2_HIWIND	32172	HIGHWINDS	34.5	34.02	1	Bay Area	Contra Costa	Aug NQC	Wind
PG&E	BRDSL_2_MTZUM2	32179	MNTZUMA2	0.69	16.42	1	Bay Area	Contra Costa	Aug NQC	Wind
PG&E	BRDSL_2_MTZUMA	32188	HIGHWIND3	0.69	7.73	1	Bay Area	Contra Costa	Aug NQC	Wind
PG&E	BRDSL_2_SHILO1	32176	SHILOH	34.5	31.50	1	Bay Area	Contra Costa	Aug NQC	Wind
PG&E	BRDSL_2_SHILO2	32177	SHILOH 2	34.5	31.50	1	Bay Area	Contra Costa	Aug NQC	Wind
PG&E	BRDSL_2_SHLO3A	32191	SHILOH3	0.58	21.53	1	Bay Area	Contra Costa	Aug NQC	Wind
PG&E	BRDSL_2_SHLO3B	32194	SHILOH4	0.58	21.00	1	Bay Area	Contra Costa	Aug NQC	Wind
PG&E	CALPIN_1_AGNEW	35860	OLS-AGNE	9.11	28.56	1	Bay Area	San Jose, South Bay-Moss Landing	Aug NQC	Market
PG&E	CAYTNO_2_VASCO	30531	0162-WD	230	4.30	FW	Bay Area	Contra Costa	Aug NQC	Market
PG&E	CLRMTK_1_QF				0.00		Bay Area	Oakland	Not modeled	QF/Selfgen
PG&E	COCOPP_2_CTG1	33188	MARSHCT1	16.4	190.00	1	Bay Area	Contra Costa	Aug NQC	Market
PG&E	COCOPP_2_CTG2	33188	MARSHCT2	16.4	189.21	2	Bay Area	Contra Costa	Aug NQC	Market
PG&E	COCOPP_2_CTG3	33189	MARSHCT3	16.4	188.50	3	Bay Area	Contra Costa	Aug NQC	Market

Attachment A - List of physical resources by PTO, local area and market ID

PG&E	COCOPP_2_CTG4	33189	MARSHCT4	16.4	189.89	4	Bay Area	Contra Costa	Aug NQC	Market
PG&E	COCOSB_6_SOLAR				0.00		Bay Area	Contra Costa	Not modeled Energy Only	Solar
PG&E	CROKET_7_UNIT	32900	CRCKTCOG	18	211.49	1	Bay Area	Pittsburg	Aug NQC	QF/Selfgen
PG&E	CSCCOG_1_UNIT 1	36859	Laf300	12	3.00	1	Bay Area	San Jose, South Bay-Moss Landing		MUNI
PG&E	CSCCOG_1_UNIT 1	36859	Laf300	12	3.00	2	Bay Area	San Jose, South Bay-Moss Landing		MUNI
PG&E	CSCGNR_1_UNIT 1	36858	Gia100	13.8	24.00	1	Bay Area	San Jose, South Bay-Moss Landing		MUNI
PG&E	CSCGNR_1_UNIT 2	36895	Gia200	13.8	24.00	2	Bay Area	San Jose, South Bay-Moss Landing		MUNI
PG&E	CUMBIA_1_SOLAR	33102	COLUMBIA	0.38	5.13	1	Bay Area	Pittsburg	Aug NQC	Solar
PG&E	DELTA_2_PL1X4	33107	DEC STG1	24	269.60	1	Bay Area	Pittsburg	Aug NQC	Market
PG&E	DELTA_2_PL1X4	33108	DEC CTG1	18	181.13	1	Bay Area	Pittsburg	Aug NQC	Market
PG&E	DELTA_2_PL1X4	33109	DEC CTG2	18	181.13	1	Bay Area	Pittsburg	Aug NQC	Market
PG&E	DELTA_2_PL1X4	33110	DEC CTG3	18	181.13	1	Bay Area	Pittsburg	Aug NQC	Market
PG&E	DIXNLD_1_LNDFL				0.64		Bay Area		Not modeled Aug NQC	Market
PG&E	DUANE_1_PL1X3	36863	DVRaGT1	13.8	48.27	1	Bay Area	San Jose, South Bay-Moss Landing		MUNI
PG&E	DUANE_1_PL1X3	36864	DVRbGT2	13.8	48.27	1	Bay Area	San Jose, South Bay-Moss Landing		MUNI
PG&E	DUANE_1_PL1X3	36865	DVRaST3	13.8	46.96	1	Bay Area	San Jose, South Bay-Moss Landing		MUNI
PG&E	GATWAY_2_PL1X3	33118	GATEWAY1	18	180.78	1	Bay Area	Contra Costa	Aug NQC	Market
PG&E	GATWAY_2_PL1X3	33119	GATEWAY2	18	171.17	1	Bay Area	Contra Costa	Aug NQC	Market
PG&E	GATWAY_2_PL1X3	33120	GATEWAY3	18	171.17	1	Bay Area	Contra Costa	Aug NQC	Market
PG&E	GILROY_1_UNIT	35850	GLRY COG	13.8	69.00	1	Bay Area	Llagas, San Jose, South Bay-Moss Landing	Aug NQC	Market

Attachment A - List of physical resources by PTO, local area and market ID

PG&E	GILROY_1_UNIT	35850	GLRY COG	13.8	36.00	2	Bay Area	Llagas, San Jose, South Bay-Moss Landing	Aug NQC	Market
PG&E	GILRPP_1_PL1X2	35851	GROYPKR1	13.8	47.60	1	Bay Area	Llagas, San Jose, South Bay-Moss Landing	Aug NQC	Market
PG&E	GILRPP_1_PL1X2	35852	GROYPKR2	13.8	47.60	1	Bay Area	Llagas, San Jose, South Bay-Moss Landing	Aug NQC	Market
PG&E	GILRPP_1_PL3X4	35853	GROYPKR3	13.8	46.20	1	Bay Area	Llagas, San Jose, South Bay-Moss Landing	Aug NQC	Market
PG&E	GRZZLY_1_BERKLY	32741	HILLSIDE_12	12.4 7	14.67	1	Bay Area		Aug NQC	Net Seller
PG&E	KELSO_2_UNITS	33813	MARIPCT1	13.8	48.09	1	Bay Area	Contra Costa	Aug NQC	Market
PG&E	KELSO_2_UNITS	33815	MARIPCT2	13.8	48.09	2	Bay Area	Contra Costa	Aug NQC	Market
PG&E	KELSO_2_UNITS	33817	MARIPCT3	13.8	48.09	3	Bay Area	Contra Costa	Aug NQC	Market
PG&E	KELSO_2_UNITS	33819	MARIPCT4	13.8	48.09	4	Bay Area	Contra Costa	Aug NQC	Market
PG&E	KIRKER_7_KELCYN				3.21		Bay Area	Pittsburg	Not modeled	Market
PG&E	LAWRNC_7_SUNYVL				0.17		Bay Area		Not modeled Aug NQC	Market
PG&E	LECEF_1_UNITS	35858	LECEFST1	13.8	111.5 8	1	Bay Area	San Jose, South Bay-Moss Landing		Market
PG&E	LECEF_1_UNITS	35854	LECEFGT1	13.8	46.49	1	Bay Area	San Jose, South Bay-Moss Landing	Aug NQC	Market
PG&E	LECEF_1_UNITS	35855	LECEFGT2	13.8	46.49	1	Bay Area	San Jose, South Bay-Moss Landing	Aug NQC	Market
PG&E	LECEF_1_UNITS	35856	LECEFGT3	13.8	46.49	1	Bay Area	San Jose, South Bay-Moss Landing	Aug NQC	Market
PG&E	LECEF_1_UNITS	35857	LECEFGT4	13.8	46.49	1	Bay Area	San Jose, South Bay-Moss Landing	Aug NQC	Market
PG&E	LMBEPK_2_UNITA1	32173	LAMBGT1	13.8	47.50	1	Bay Area	Contra Costa	Aug NQC	Market
PG&E	LMBEPK_2_UNITA2	32174	GOOSEHGT	13.8	47.60	2	Bay Area	Contra Costa	Aug NQC	Market
PG&E	LMBEPK_2_UNITA3	32175	CREEDGT1	13.8	47.40	3	Bay Area	Contra Costa	Aug NQC	Market
PG&E	LMEC_1_PL1X3	33113	LMECST1	18	243.7 1	1	Bay Area	Pittsburg	Aug NQC	Market
PG&E	LMEC_1_PL1X3	33111	LMECCT2	18	165.4 1	1	Bay Area	Pittsburg	Aug NQC	Market
PG&E	LMEC_1_PL1X3	33112	LMECCT1	18	165.4 1	1	Bay Area	Pittsburg	Aug NQC	Market

Attachment A - List of physical resources by PTO, local area and market ID

PG&E	MARTIN_1_SUNSET				1.22		Bay Area		Not modeled Aug NQC	QF/Selfgen
PG&E	METEC_2_PL1X3	35883	MEC STG1	18	213.1 3	1	Bay Area	San Jose, South Bay-Moss Landing	Aug NQC	Market
PG&E	METEC_2_PL1X3	35881	MEC CTG1	18	178.4 3	1	Bay Area	San Jose, South Bay-Moss Landing	Aug NQC	Market
PG&E	METEC_2_PL1X3	35882	MEC CTG2	18	178.4 3	1	Bay Area	San Jose, South Bay-Moss Landing	Aug NQC	Market
PG&E	MISSIX_1_QF				0.01		Bay Area		Not modeled Aug NQC	QF/Selfgen
PG&E	MLPTAS_7_QFUNTS				0.00		Bay Area	San Jose, South Bay-Moss Landing	Not modeled Aug NQC	QF/Selfgen
PG&E	MOSSLD_1_QF				0.00		Bay Area		Not modeled Aug NQC	Market
PG&E	MOSSLD_2_PSP1	36223	DUKMOSS3	18	183.6 0	1	Bay Area	South Bay-Moss Landing	78% starting 2021	Market
PG&E	MOSSLD_2_PSP1	36221	DUKMOSS1	18	163.2 0	1	Bay Area	South Bay-Moss Landing	78% starting 2021	Market
PG&E	MOSSLD_2_PSP1	36222	DUKMOSS2	18	163.2 0	1	Bay Area	South Bay-Moss Landing	78% starting 2021	Market
PG&E	MOSSLD_2_PSP2	36226	DUKMOSS6	18	183.6 0	1	Bay Area	South Bay-Moss Landing	78% starting 2021	Market
PG&E	MOSSLD_2_PSP2	36224	DUKMOSS4	18	163.2 0	1	Bay Area	South Bay-Moss Landing	78% starting 2021	Market
PG&E	MOSSLD_2_PSP2	36225	DUKMOSS5	18	163.2 0	1	Bay Area	South Bay-Moss Landing	78% starting 2021	Market
PG&E	NEWARK_1_QF				0.05		Bay Area		Not modeled Aug NQC	QF/Selfgen
PG&E	OAK C_1_EBMUD				1.20		Bay Area	Oakland	Not modeled Aug NQC	MUNI
PG&E	OAK C_7_UNIT 1	32901	OAKLND 1	13.8	0.00	1	Bay Area	Oakland	Retired by 2025	Market
PG&E	OAK C_7_UNIT 2	32902	OAKLND 2	13.8	0.00	1	Bay Area	Oakland	Retired by 2025	Market
PG&E	OAK C_7_UNIT 3	32903	OAKLND 3	13.8	0.00	1	Bay Area	Oakland	Retired by 2021	Market
PG&E	OAK L_1_GTG1				0.00		Bay Area	Oakland	Not modeled Energy Only	Market
PG&E	OXMTN_6_LNDFIL	33469	OX_MTN	4.16	1.47	1	Bay Area	Ames		Market
PG&E	OXMTN_6_LNDFIL	33469	OX_MTN	4.16	1.47	2	Bay Area	Ames		Market

Attachment A - List of physical resources by PTO, local area and market ID

PG&E	OXMTN_6_LNDFIL	33469	OX_MTN	4.16	1.47	3	Bay Area	Ames		Market
PG&E	OXMTN_6_LNDFIL	33469	OX_MTN	4.16	1.47	4	Bay Area	Ames		Market
PG&E	OXMTN_6_LNDFIL	33469	OX_MTN	4.16	1.47	5	Bay Area	Ames		Market
PG&E	OXMTN_6_LNDFIL	33469	OX_MTN	4.16	1.47	6	Bay Area	Ames		Market
PG&E	OXMTN_6_LNDFIL	33469	OX_MTN	4.16	1.47	7	Bay Area	Ames		Market
PG&E	PALALT_7_COBUG				4.50		Bay Area		Not modeled	MUNI
PG&E	RICHMN_1_CHVSR2				2.30		Bay Area		Not modeled Aug NQC	Solar
PG&E	RICHMN_1_SOLAR				0.54		Bay Area		Not modeled Aug NQC	Solar
PG&E	RICHMN_7_BAYENV				2.00		Bay Area		Not modeled Aug NQC	Market
PG&E	RUSCTY_2_UNITS	35306	RUSELST1	15	237.0 9	3	Bay Area	Ames	No NQC - Pmax	Market
PG&E	RUSCTY_2_UNITS	35304	RUSELCT1	15	180.1 5	1	Bay Area	Ames	No NQC - Pmax	Market
PG&E	RUSCTY_2_UNITS	35305	RUSELCT2	15	180.1 5	2	Bay Area	Ames	No NQC - Pmax	Market
PG&E	RVRVEW_1_UNITA1	33178	RVEC_GEN	13.8	47.60	1	Bay Area	Contra Costa	Aug NQC	Market
PG&E	SHELRF_1_UNITS	33142	SHELL 2	12.4 7	10.91	1	Bay Area	Pittsburg	Aug NQC	Net Seller
PG&E	SHELRF_1_UNITS	33143	SHELL 3	12.4 7	10.91	1	Bay Area	Pittsburg	Aug NQC	Net Seller
PG&E	SHELRF_1_UNITS	33141	SHELL 1	12.4 7	5.88	1	Bay Area	Pittsburg	Aug NQC	Net Seller
PG&E	SRINTL_6_UNIT	33468	SRI INTL	9.11	0.78	1	Bay Area		Aug NQC	QF/Selfgen
PG&E	STAUFF_1_UNIT	33139	STAUFER	9.11	0.01	1	Bay Area		Aug NQC	QF/Selfgen
PG&E	STOILS_1_UNITS	32921	CHEVGEN1	13.8	2.09	1	Bay Area	Pittsburg	Aug NQC	Market
PG&E	STOILS_1_UNITS	32922	CHEVGEN2	13.8	2.09	1	Bay Area	Pittsburg	Aug NQC	Market
PG&E	STOILS_1_UNITS	32923	CHEVGEN3	13.8	0.97	3	Bay Area	Pittsburg	Aug NQC	Market
PG&E	SWIFT_1_NAS	35623	SWIFT	21	3.00	BT	Bay Area	San Jose, South Bay-Moss Landing		Battery
PG&E	TIDWTR_2_UNITS	33151	FOSTER W	12.4 7	4.05	1	Bay Area	Pittsburg	Aug NQC	Net Seller
PG&E	TIDWTR_2_UNITS	33151	FOSTER W	12.4 7	4.05	2	Bay Area	Pittsburg	Aug NQC	Net Seller
PG&E	TIDWTR_2_UNITS	33151	FOSTER W	12.4 7	3.08	3	Bay Area	Pittsburg	Aug NQC	Net Seller
PG&E	UNCHEM_1_UNIT	32920	UNION CH	9.11	13.10	1	Bay Area	Pittsburg	Aug NQC	QF/Selfgen
PG&E	UNOCAL_1_UNITS	32910	UNOCAL	12	0.02	1	Bay Area	Pittsburg	Aug NQC	QF/Selfgen

Attachment A - List of physical resources by PTO, local area and market ID

PG&E	UNOCAL_1_UNITS	32910	UNOCAL	12	0.02	2	Bay Area	Pittsburg	Aug NQC	QF/Selfgen
PG&E	UNOCAL_1_UNITS	32910	UNOCAL	12	0.02	3	Bay Area	Pittsburg	Aug NQC	QF/Selfgen
PG&E	USWNRD_2_LABWD1				1.89		Bay Area	Contra Costa	Aug NQC	Wind
PG&E	USWNRD_2_SMUD	36557 4	SOLANO2W		18.24	2	Bay Area	Contra Costa	Aug NQC	Wind
PG&E	USWNRD_2_SMUD	36556 6	SOLANO1W		3.22	1	Bay Area	Contra Costa	Aug NQC	Wind
PG&E	USWNRD_2_SMUD2	36560 0	SOLANO3W		26.84	3	Bay Area	Contra Costa	Aug NQC	Wind
PG&E	USWPJR_2_UNITS	39233	GRNRDG	0.69	16.42	1	Bay Area	Contra Costa	Aug NQC	Wind
PG&E	WNDMAS_2_UNIT 1	33170	WINDMSTR	9.11	7.98	1	Bay Area	Contra Costa	Aug NQC	Wind
PG&E	ZOND_6_UNIT	35316	ZOND SYS	9.11	3.59	1	Bay Area	Contra Costa	Aug NQC	Wind
PG&E	ZZ_IBMCTL_1_UNIT 1	35637	IBM-CTLE	115	0.00	1	Bay Area	San Jose, South Bay-Moss Landing	No NQC - hist. data	Market
PG&E	ZZ_IMHOFF_1_UNIT 1	33136	CCCSD	12.4 7	0.00	1	Bay Area	Pittsburg	No NQC - hist. data	QF/Selfgen
PG&E	ZZ_MARKHM_1_CATLST	35863	CATALYST	9.11	0.00	1	Bay Area	San Jose, South Bay-Moss Landing		QF/Selfgen
PG&E	ZZ_NA	35861	SJ-SCL W	4.3	0.00	1	Bay Area	San Jose, South Bay-Moss Landing	No NQC - hist. data	QF/Selfgen
PG&E	ZZ_NA	36209	SLD ENRG	12.4 7	0.00	1	Bay Area	South Bay-Moss Landing		QF/Selfgen
PG&E	ZZ_SEAWST_6_LAPOS	35312	FOREBAYW	22.0 1	0.00	1	Bay Area	Contra Costa	No NQC - est. data	Wind
PG&E	ZZ_USWPFK_6_FRICK	35320	FRICKWND	12	1.90	1	Bay Area	Contra Costa	Aug NQC	Wind
PG&E	ZZ_USWPFK_6_FRICK	35320	FRICKWND	12	0.00	2	Bay Area	Contra Costa	Aug NQC	Wind
PG&E	ZZ_ZANKER_1_UNIT 1	35861	SJ-SCL W	4.3	0.00	RN	Bay Area	San Jose, South Bay-Moss Landing	No NQC - hist. data	QF/Selfgen
PG&E	ZZZ_New Unit	30045	MOSSLAND	500	300.0 0	ES	Bay Area	South Bay-Moss Landing	E-4949	Battery
PG&E	ZZZ_New Unit	30755	MOSSLNSW	230	182.5 0	ES	Bay Area	South Bay-Moss Landing	E-4949	Battery
PG&E	ZZZ_New Unit	35646	MGRN HIL	115	75.00	ES	Bay Area	San Jose, South Bay-Moss Landing	E-4949	Battery
PG&E	ZZZ_New Unit	30522	0354-WD	21	1.83	EW	Bay Area	Contra Costa	No NQC - Pmax	Market
PG&E	ZZZ_New Unit	36554 0	Q1016		0.00	1	Bay Area		Energy Only	Market
PG&E	ZZZ_New Unit	32741	HILLSIDE		0.00	RN	Bay Area		Energy Only	Market

Attachment A - List of physical resources by PTO, local area and market ID

PG&E	ZZZ_New Unit	36559	STANFORD		0.00	RN	Bay Area		Energy Only	Market
PG&E	ZZZ_New Unit	35302	NUMMI-LV	12.56	0.00	RN	Bay Area		Energy Only	Market
PG&E	ZZZ_New Unit	35859	HGST-LV	12.41	0.00	RN	Bay Area		Energy Only	Market
PG&E	ZZZ_New Unit	35307	A100US-L	12.56	0.00	RN	Bay Area		Energy Only	Market
PG&E	ZZZZ_New Unit	32786	OAK C115	115	10.00	ES	Bay Area	Oakland	OCEI	Battery
PG&E	ZZZZ_New Unit	32908	OAK C12	12	2.50	ES	Bay Area	Oakland	OCEI	Battery
PG&E	ZZZZ_New Unit	32788	STTIN L	115	2.50	ES	Bay Area	Oakland	OCEI	Battery
PG&E	ZZZZZ_METCLF_1_QF				0.00		Bay Area		Retired	QF/Selfgen
PG&E	ZZZZZ_USWNRD_2_UNIT S	32168	EXNCO	9.11	0.00	1	Bay Area	Contra Costa	Retired	Wind
PG&E	ZZZZZ_COCOPP_7_UNIT 6	33116	C.COS 6	18	0.00	RT	Bay Area	Contra Costa	Retired	Market
PG&E	ZZZZZ_COCOPP_7_UNIT 7	33117	C.COS 7	18	0.00	RT	Bay Area	Contra Costa	Retired	Market
PG&E	ZZZZZ_CONTAN_1_UNIT T	36856	CCA100	13.8	0.00	1	Bay Area	San Jose, South Bay-Moss Landing	Retired	MUNI
PG&E	ZZZZZ_FLOWD1_6_ALT PP1	35318	FLOWDPTR	9.11	0.00	1	Bay Area	Contra Costa	Retired	Wind
PG&E	ZZZZZ_LFC 51_2_UNIT 1	35310	PPASSWND	21	0.00	1	Bay Area		Retired	Wind
PG&E	ZZZZZ_MOSSLD_7_UNIT 6	36405	MOSSLND6	22	0.00	1	Bay Area	South Bay-Moss Landing	Retired	Market
PG&E	ZZZZZ_MOSSLD_7_UNIT 7	36406	MOSSLND7	22	0.00	1	Bay Area	South Bay-Moss Landing	Retired	Market
PG&E	ZZZZZ_PITTSP_7_UNIT 5	33105	PTSB 5	18	0.00	RT	Bay Area	Pittsburg	Retired	Market
PG&E	ZZZZZ_PITTSP_7_UNIT 6	33106	PTSB 6	18	0.00	RT	Bay Area	Pittsburg	Retired	Market
PG&E	ZZZZZ_PITTSP_7_UNIT 7	30000	PTSB 7	20	0.00	RT	Bay Area	Pittsburg	Retired	Market
PG&E	ZZZZZ_UNTDQF_7_UNITS	33466	UNTED CO	9.11	0.00	1	Bay Area		Retired	QF/Selfgen
PG&E	ADERA_1_SOLAR1	34319	CHWCHLAS	0.48	0.00	1	Fresno	Herndon, Panoche 115 kV, Wilson 115 kV	Energy Only	Solar
PG&E	ADMEST_6_SOLAR	34315	ADAMS_E	12.47	0.00	1	Fresno	Herndon	Energy Only	Solar

Attachment A - List of physical resources by PTO, local area and market ID

PG&E	AGRICO_6_PL3N5	34608	AGRICO	13.8	22.69	3	Fresno	Herndon		Market
PG&E	AGRICO_7_UNIT	34608	AGRICO	13.8	43.13	4	Fresno	Herndon		Market
PG&E	AGRICO_7_UNIT	34608	AGRICO	13.8	7.47	2	Fresno	Herndon		Market
PG&E	AVENAL_6_AVPARK	34265	AVENAL P	12	0.00	1	Fresno	Coalinga	Aug NQC	Solar
PG&E	AVENAL_6_AVSLR1	34691	AVENAL_1	21	0.00	EW	Fresno	Coalinga	Energy Only	Solar
PG&E	AVENAL_6_AVSLR2	34691	AVENAL_1	21	0.00	EW	Fresno	Coalinga	Energy Only	Solar
PG&E	AVENAL_6_SANDDG	34263	SANDDRAG	12	0.00	1	Fresno	Coalinga	Aug NQC	Solar
PG&E	AVENAL_6_SUNCTY	34257	SUNCTY D	12	0.00	1	Fresno	Coalinga	Aug NQC	Solar
PG&E	BALCHS_7_UNIT 1	34624	BALCH	13.2	31.00	1	Fresno	Herndon	Aug NQC	Market
PG&E	BALCHS_7_UNIT 2	34612	BLCH	13.8	52.50	1	Fresno	Herndon	Aug NQC	Market
PG&E	BALCHS_7_UNIT 3	34614	BLCH	13.8	54.60	1	Fresno	Herndon	Aug NQC	Market
PG&E	CANTUA_1_SOLAR	34349	CANTUA_D	12.4 7	2.70	1	Fresno	Panoche 115 kV	Aug NQC	Solar
PG&E	CANTUA_1_SOLAR	34349	CANTUA_D	12.4 7	2.70	2	Fresno	Panoche 115 kV	Aug NQC	Solar
PG&E	CHEVCO_6_UNIT 1	34652	CHV.COAL	9.11	2.09	1	Fresno	Coalinga, Panoche 115 kV	Aug NQC	QF/Selfgen
PG&E	CHEVCO_6_UNIT 2	34652	CHV.COAL	9.11	0.85	2	Fresno	Coalinga, Panoche 115 kV	Aug NQC	QF/Selfgen
PG&E	CHWCHL_1_BIOMAS	34305	CHWCHLA2	13.8	9.30	1	Fresno	Herndon, Panoche 115 kV, Wilson 115 kV	Aug NQC	Market
PG&E	CHWCHL_1_UNIT	34301	CHOWCOGN	13.8	48.00	1	Fresno	Herndon, Panoche 115 kV, Wilson 115 kV		Market
PG&E	CORCAN_1_SOLAR1	34690	CORCORAN	12.4 7	5.40	FW	Fresno	Herndon, Hanford	Aug NQC	Solar
PG&E	CORCAN_1_SOLAR2	34692	CORCORAN	12.4 7	2.97	FW	Fresno	Herndon, Hanford	Aug NQC	Solar
PG&E	CRESSY_1_PARKER	34140	CRESSEY	115	1.29		Fresno		Not modeled Aug NQC	MUNI
PG&E	CRNEVL_6_CRNVA	34634	CRANEVLY	12	0.00	1	Fresno	Borden	Aug NQC	Market
PG&E	CRNEVL_6_SJQN 2	34631	SJ2GEN	9.11	0.01	1	Fresno	Borden	Aug NQC	Market
PG&E	CRNEVL_6_SJQN 3	34633	SJ3GEN	9.11	0.00	1	Fresno	Borden	Aug NQC	Market
PG&E	CURTIS_1_CANLCK				0.00		Fresno		Not modeled Aug NQC	Market
PG&E	CURTIS_1_FARFLD				0.47		Fresno		Not modeled Aug NQC	Market
PG&E	DAIRLD_1_MD1SL1				0.00		Fresno		Energy Only	Solar
PG&E	DAIRLD_1_MD2BM1				0.00		Fresno		Energy Only	Market

Attachment A - List of physical resources by PTO, local area and market ID

PG&E	DINUBA_6_UNIT	34648	DINUBA E	13.8	0.00	1	Fresno	Herndon, Reedley	Mothballed	Market
PG&E	EEKTMN_6_SOLAR1	34629	KETTLEMN	0.8	0.00	1	Fresno		Energy Only	Solar
PG&E	ELCAP_1_SOLAR				0.00		Fresno		Not Modeled Aug NQC	Solar
PG&E	ELNIDP_6_BIOMAS	34330	ELNIDO	13.8	9.59	1	Fresno	Panoche 115 kV, Wilson 115 kV	Aug NQC	Market
PG&E	EXCHEC_7_UNIT 1	34306	EXCHQUER	13.8	90.72	1	Fresno	Panoche 115 kV, Wilson 115 kV	Aug NQC	MUNI
PG&E	EXCLSG_1_SOLAR	34623	Q678	0.5	16.20	1	Fresno	Panoche 115 kV	Aug NQC	Solar
PG&E	FRESHW_1_SOLAR1	34699	Q529	0.38 5	0.00	1	Fresno	Herndon	Energy Only	Solar
PG&E	FRIANT_6_UNITS	34636	FRIANTDM	6.6	8.56	2	Fresno	Borden	Aug NQC	Net Seller
PG&E	FRIANT_6_UNITS	34636	FRIANTDM	6.6	4.57	3	Fresno	Borden	Aug NQC	Net Seller
PG&E	FRIANT_6_UNITS	34636	FRIANTDM	6.6	1.21	4	Fresno	Borden	Aug NQC	Net Seller
PG&E	GIFENS_6_BUGSL1	34644	Q679	0.55	5.40	1	Fresno		Aug NQC	Solar
PG&E	GIFFEN_6_SOLAR	34467	GIFFEN_DIST	12.4 7	2.70	1	Fresno	Herndon	Aug NQC	Solar
PG&E	GIFFEN_6_SOLAR1				0.00	1	Fresno	Herndon	Energy Only	Solar
PG&E	GUERNS_6_SOLAR	34463	GUERNSEY_ D2	12.4 7	2.70	5	Fresno		Aug NQC	Solar
PG&E	GUERNS_6_SOLAR	34461	GUERNSEY_ D1	12.4 7	2.70	8	Fresno		Aug NQC	Solar
PG&E	GWFPWR_1_UNITS	34431	GWF_HEP1	13.8	45.30	1	Fresno	Herndon, Hanford		Market
PG&E	GWFPWR_1_UNITS	34433	GWF_HEP2	13.8	45.30	1	Fresno	Herndon, Hanford		Market
PG&E	HAASPH_7_PL1X2	34610	HAAS	13.8	72.00	1	Fresno	Herndon	Aug NQC	Market
PG&E	HAASPH_7_PL1X2	34610	HAAS	13.8	72.00	2	Fresno	Herndon	Aug NQC	Market
PG&E	HELMPG_7_UNIT 1	34600	HELMS	18	407.0 0	1	Fresno		Aug NQC	Market
PG&E	HELMPG_7_UNIT 2	34602	HELMS	18	407.0 0	2	Fresno		Aug NQC	Market
PG&E	HELMPG_7_UNIT 3	34604	HELMS	18	404.0 0	3	Fresno		Aug NQC	Market
PG&E	HENRTA_6_SOLAR1				0.00		Fresno		Not modeled Aug NQC	Solar
PG&E	HENRTA_6_SOLAR2				0.00		Fresno		Not modeled Energy Only	Solar
PG&E	HENRTA_6_UNITA1	34539	GWF_GT1	13.8	44.99	1	Fresno			Market
PG&E	HENRTA_6_UNITA2	34541	GWF_GT2	13.8	44.89	1	Fresno			Market
PG&E	HENRTS_1_SOLAR	34617	Q581	0.38	27.00	1	Fresno	Herndon	Aug NQC	Solar

Attachment A - List of physical resources by PTO, local area and market ID

PG&E	HURON_6_SOLAR	34557	HURON_DI	12.4 7	2.70	1	Fresno	Coalinga, Panoche 115 kV	Aug NQC	Solar
PG&E	HURON_6_SOLAR	34557	HURON_DI	12.4 7	2.70	2	Fresno	Coalinga, Panoche 115 kV	Aug NQC	Solar
PG&E	JAYNE_6_WLSLR	34639	WESTLNDS	0.48	0.00	1	Fresno	Coalinga	Energy Only	Solar
PG&E	KANSAS_6_SOLAR	34666	KANSASS_S	12.4 7	0.00	F	Fresno		Energy Only	Solar
PG&E	KERKH1_7_UNIT 1	34344	KERCK1-1	6.6	13.00	1	Fresno	Herndon, Wilson 115 kV	Aug NQC	Market
PG&E	KERKH1_7_UNIT 3	34345	KERCK1-3	6.6	12.80	3	Fresno	Herndon, Wilson 115 kV	Aug NQC	Market
PG&E	KERKH2_7_UNIT 1	34308	KERCKHOF	13.8	153.9 0	1	Fresno	Herndon, Wilson 115 kV	Aug NQC	Market
PG&E	KERMAN_6_SOLAR1				0.00		Fresno		Not modeled Energy Only	Solar
PG&E	KERMAN_6_SOLAR2				0.00		Fresno		Not modeled Energy Only	Solar
PG&E	KINGCO_1_KINGBR	34642	KINGSBUR	9.11	34.50	1	Fresno	Herndon, Hanford	Aug NQC	Net Seller
PG&E	KINGRV_7_UNIT 1	34616	KINGSRIV	13.8	51.20	1	Fresno	Herndon, Reedley	Aug NQC	Market
PG&E	KNGBRG_1_KBSLR1				0.00		Fresno		Not modeled Energy Only	Solar
PG&E	KNGBRG_1_KBSLR2				0.00		Fresno		Not modeled Energy Only	Solar
PG&E	KNTSTH_6_SOLAR	34694	KENT_S	0.8	0.00	1	Fresno		Energy Only	Solar
PG&E	LEPRFD_1_KANSAS	34680	KANSAS	12.4 7	5.40	1	Fresno	Herndon, Hanford	Aug NQC	Solar
PG&E	MALAGA_1_PL1X2	34671	KRCDPCT1	13.8	48.00	1	Fresno	Herndon		Market
PG&E	MALAGA_1_PL1X2	34672	KRCDPCT2	13.8	48.00	1	Fresno	Herndon		Market
PG&E	MCCALL_1_QF	34219	MCCALL 4	12.4 7	0.65	QF	Fresno	Herndon	Aug NQC	QF/Selfgen
PG&E	MCSWAN_6_UNITS	34320	MCSWAIN	9.11	9.60	1	Fresno	Panoche 115 kV, Wilson 115 kV	Aug NQC	MUNI
PG&E	MENBIO_6_RENEW1	34339	CALRENEW	12.5	1.35	1	Fresno	Herndon, Panoche 115 kV, Wilson 115 kV	Aug NQC	Net Seller
PG&E	MERCED_1_SOLAR1				0.00		Fresno		Not modeled Energy Only	Solar
PG&E	MERCED_1_SOLAR2				0.00		Fresno		Not modeled Energy Only	Solar

Attachment A - List of physical resources by PTO, local area and market ID

PG&E	MERCFL_6_UNIT	34322	MERCEDFL	9.11	3.36	1	Fresno	Panoche 115 kV, Wilson 115 kV	Aug NQC	Market
PG&E	MNDOTA_1_SOLAR1	34313	NORTHSTA	0.2	16.20	1	Fresno	Panoche 115 kV, Wilson 115 kV	Aug NQC	Solar
PG&E	MNDOTA_1_SOLAR2				0.00		Fresno		Not modeled Energy Only	Solar
PG&E	MSTANG_2_SOLAR	34683	Q643W	0.8	8.10	1	Fresno		Aug NQC	Solar
PG&E	MSTANG_2_SOLAR3	34683	Q643W	0.8	10.80	1	Fresno		Aug NQC	Solar
PG&E	MSTANG_2_SOLAR4	34683	Q643W	0.8	8.10	1	Fresno		Aug NQC	Solar
PG&E	ONLLPP_6_UNITS	34316	ONEILPMP	9.11	12.12	1	Fresno		Aug NQC	MUNI
PG&E	OROLOM_1_SOLAR1	34689	ORO LOMA_3	12.4 7	0.00	EW	Fresno	Panoche 115 kV	Energy Only	Solar
PG&E	OROLOM_1_SOLAR2	34689	ORO LOMA_3	12.4 7	0.00	EW	Fresno	Panoche 115 kV	Energy Only	Solar
PG&E	ORTGA_6_ME1SL1				0.00		Fresno		Not modeled Energy Only	Solar
PG&E	PAIGES_6_SOLAR	34653	Q526	0.55	0.00	1	Fresno	Coalinga, Panoche 115 kV	Energy Only	Solar
PG&E	PINFLT_7_UNITS	38720	PINEFLAT	13.8	32.63	1	Fresno	Herndon	Aug NQC	MUNI
PG&E	PINFLT_7_UNITS	38720	PINEFLAT	13.8	32.63	2	Fresno	Herndon	Aug NQC	MUNI
PG&E	PINFLT_7_UNITS	38720	PINEFLAT	13.8	32.63	3	Fresno	Herndon	Aug NQC	MUNI
PG&E	PNCHPP_1_PL1X2	34328	STARGT1	13.8	54.18	1	Fresno	Panoche 115 kV		Market
PG&E	PNCHPP_1_PL1X2	34329	STARGT2	13.8	54.18	2	Fresno	Panoche 115 kV		Market
PG&E	PNOCHE_1_PL1X2	34142	WHD_PAN2	13.8	49.97	1	Fresno	Herndon, Panoche 115 kV		Market
PG&E	PNOCHE_1_UNITA1	34186	DG_PAN1	13.8	52.01	1	Fresno	Panoche 115 kV		Market
PG&E	REEDLY_6_SOLAR				0.00		Fresno	Herndon, Reedley	Not modeled Energy Only	Solar
PG&E	S_RITA_6_SOLAR1				0.00		Fresno		Not modeled Energy Only	Solar
PG&E	SCHNDR_1_FIVPTS	34353	SCHINDLER_ D	12.4 7	2.70	1	Fresno	Coalinga, Panoche 115 kV	Aug NQC	Solar
PG&E	SCHNDR_1_FIVPTS	34353	SCHINDLER_ D	12.4 7	1.35	2	Fresno	Coalinga, Panoche 115 kV	Aug NQC	Solar
PG&E	SCHNDR_1_OS2BM2				0.00		Fresno	Coalinga	Energy Only	Market
PG&E	SCHNDR_1_WSTSDE	34353	SCHINDLER_ D	12.4 7	2.70	3	Fresno	Coalinga, Panoche 115 kV	Aug NQC	Solar
PG&E	SCHNDR_1_WSTSDE	34353	SCHINDLER_ D	12.4 7	1.35	4	Fresno	Coalinga, Panoche 115 kV	Aug NQC	Solar
PG&E	SGREGY_6_SANGER	34646	SANGERCO	13.8	38.77	1	Fresno	Herndon	Aug NQC	Market

Attachment A - List of physical resources by PTO, local area and market ID

PG&E	SGREGY_6_SANGER	34646	SANGERCO	13.8	9.31	2	Fresno	Herndon	Aug NQC	Market
PG&E	STOREY_2_MDRCH2	34253	BORDEN D	12.4 7	0.28		Fresno		Not modeled Aug NQC	Market
PG&E	STOREY_2_MDRCH3	34253	BORDEN D	12.4 7	0.19		Fresno		Not modeled Aug NQC	Market
PG&E	STOREY_2_MDRCH4	34253	BORDEN D	12.4 7	0.20		Fresno		Not modeled Aug NQC	Market
PG&E	STOREY_7_MDRCHW	34209	STOREY D	12.4 7	0.82	1	Fresno		Aug NQC	Net Seller
PG&E	STROUD_6_SOLAR	34563	STROUD_D	12.4 7	2.70	1	Fresno	Herndon	Aug NQC	Solar
PG&E	STROUD_6_SOLAR	34563	STROUD_D	12.4 7	2.70	2	Fresno	Herndon	Aug NQC	Solar
PG&E	STROUD_6_WWHSR1				0.00		Fresno	Herndon	Energy Only	Solar
PG&E	SUMWHT_6_SWSSR1				5.00		Fresno		Aug NQC	Solar
PG&E	TRNQL8_2_AMASR1	36551 4	Q1032G1	0.55	5.40	1	Fresno		Aug NQC	Solar
PG&E	TRNQL8_2_AZUSR1	36551 7	Q1032G2	0.55	5.40	2	Fresno		Aug NQC	Solar
PG&E	TRNQL8_2_ROJSR1	36552 0	Q1032G3	0.55	8.10	3	Fresno		Aug NQC	Solar
PG&E	TRNQL8_2_VERSR1	36552 0	Q1032G3	0.55	0.00	3	Fresno		Aug NQC	Solar
PG&E	TRNQLT_2_SOLAR	34340	Q643X	0.8	54.00	1	Fresno		Aug NQC	Solar
PG&E	ULTPFR_1_UNIT 1	34640	ULTR.PWR	9.11	24.07	1	Fresno	Herndon	Aug NQC	Market
PG&E	VEGA_6_SOLAR1	34314	VEGA	34.5	0.00	1	Fresno		Energy Only	Solar
PG&E	WAUKNA_1_SOLAR	34696	CORCORANP V_S	21	5.40	1	Fresno	Herndon, Hanford	Aug NQC	Solar
PG&E	WAUKNA_1_SOLAR2	34677	Q558	21	5.33	1	Fresno	Herndon, Hanford	No NQC - Pmax	Solar
PG&E	WFRESN_1_SOLAR				0.00		Fresno		Not modeled Energy Only	Solar
PG&E	WHITNY_6_SOLAR	34673	Q532	0.55	0.00	1	Fresno	Coalinga, Panoche 115 kV	Energy Only	Solar
PG&E	WISHON_6_UNITS	34658	WISHON	2.3	4.51	1	Fresno	Borden	Aug NQC	Market
PG&E	WISHON_6_UNITS	34658	WISHON	2.3	4.51	2	Fresno	Borden	Aug NQC	Market
PG&E	WISHON_6_UNITS	34658	WISHON	2.3	4.51	3	Fresno	Borden	Aug NQC	Market
PG&E	WISHON_6_UNITS	34658	WISHON	2.3	4.51	4	Fresno	Borden	Aug NQC	Market
PG&E	WISHON_6_UNITS	34658	WISHON	2.3	0.36	SJ	Fresno	Borden	Aug NQC	Market
PG&E	WOODWR_1_HYDRO				0.00		Fresno		Not modeled Energy Only	Market

Attachment A - List of physical resources by PTO, local area and market ID

PG&E	WRGHTP_7_AMENGY	34207	WRIGHT D	12.4 7	0.53	QF	Fresno		Aug NQC	QF/Selfgen
PG&E	ZZ_BORDEN_2_QF	34253	BORDEN D	12.4 7	1.30	QF	Fresno		No NQC - hist. data	Net Seller
PG&E	ZZ_BULLRD_7_SAGNES	34213	BULLD 12	12.4 7	0.06	1	Fresno	Herndon	Aug NQC	QF/Selfgen
PG&E	ZZ_JRWOOD_1_UNIT 1	34332	JRWCOGEN	9.11	0.00	1	Fresno			QF/Selfgen
PG&E	ZZ_KERKH1_7_UNIT 2	34343	KERCK1-2	6.6	8.50	2	Fresno	Herndon, Wilson 115 kV	No NQC - hist. data	Market
PG&E	ZZ_NA	34485	FRESNOWW	12.5	0.10	2	Fresno		No NQC - hist. data	QF/Selfgen
PG&E	ZZ_NA	34485	FRESNOWW	12.5	0.00	1	Fresno		No NQC - hist. data	QF/Selfgen
PG&E	ZZ_NA	34485	FRESNOWW	12.5	0.00	3	Fresno		No NQC - hist. data	QF/Selfgen
PG&E	ZZ_New Unit	34651	JACALITO-LV	0.55	1.22	RN	Fresno		No NQC - Pmax	Market
PG&E	ZZZ_New Unit	36569 7	Q1158B	0.36	300.0 0	1	Fresno		No NQC - est. data	Battery
PG&E	ZZZ_New Unit	36552 4	Q1036SPV	0.36	41.42	1	Fresno		No NQC - est. data	Solar
PG&E	ZZZ_New Unit	34688	Q272	0.36	33.21	1	Fresno		No NQC - est. data	Solar
PG&E	ZZZ_New Unit	36567 5	Q1128-5S	0.36	13.50	1	Fresno	Panoche 115 kV, Wilson 115 kV	No NQC - est. data	Solar
PG&E	ZZZ_New Unit	36567 3	Q1128-4S	0.36	13.50	1	Fresno	Panoche 115 kV, Wilson 115 kV	No NQC - est. data	Solar
PG&E	ZZZ_New Unit	34335	Q723	0.31 5	13.50	1	Fresno	Borden	No NQC - est. data	Solar
PG&E	ZZZ_New Unit	36560 4	Q1028Q10	0.36	5.40	1	Fresno	Panoche 115 kV, Wilson 115 kV	No NQC - est. data	Solar
PG&E	ZZZ_New Unit	36566 3	Q1127SPV	0.36	5.40	1	Fresno	Panoche 115 kV, Wilson 115 kV	No NQC - est. data	Solar
PG&E	ZZZ_New Unit	36550 4	Q632BSPV	0.55	5.00	1	Fresno		No NQC - est. data	Solar
PG&E	ZZZ_New Unit	34649	Q965SPV	0.36	3.65	1	Fresno	Herndon	No NQC - est. data	Solar
PG&E	ZZZ_New Unit	36569 4	Q1158S	0.36	0.00	1	Fresno		No NQC - est. data	Solar

Attachment A - List of physical resources by PTO, local area and market ID

PG&E	ZZZ_New Unit	34603	JGBSWLT	12.4 7	0.00	ST	Fresno	Herndon	Energy Only	Market
PG&E	ZZZZ_CAPMAD_1_UNIT 1	34179	MADERA_G	13.8	0.00	RT	Fresno		Retired	Market
PG&E	ZZZZ_COLGA1_6_SHEL LW	34654	COLNGAGN	9.11	0.00	1	Fresno	Coalinga	Retired	Net Seller
PG&E	ZZZZ_GATES_6_PL1X2	34553	WHD_GAT2	13.8	0.00	RT	Fresno	Coalinga	Retired	Market
PG&E	ZZZZ_INTTRB_6_UNIT	34342	INT.TURB	9.11	0.00	1	Fresno		Aug NQC	Market
PG&E	ZZZZ_MENBIO_6_UNIT	34334	BIO PWR	9.11	0.00	1	Fresno	Panoche 115 kV, Wilson 115 kV	Retired	QF/Selfgen
PG&E	BRDGLV_7_BAKER				0.00		Humboldt		Not modeled Aug NQC	Net Seller
PG&E	FAIRHV_6_UNIT	31150	FAIRHAVN	13.8	12.65	1	Humboldt		Aug NQC	Net Seller
PG&E	FTSWRD_6_TRFORK				0.15		Humboldt		Not modeled Aug NQC	Market
PG&E	FTSWRD_7_QFUNTS				0.00		Humboldt		Not modeled Aug NQC	QF/Selfgen
PG&E	GRSCRK_6_BGCKWW				0.00		Humboldt		Not modeled Aug NQC	Market
PG&E	HUMBPP_1_UNITS3	31180	HUMB_G1	13.8	16.69	3	Humboldt			Market
PG&E	HUMBPP_1_UNITS3	31180	HUMB_G1	13.8	16.32	1	Humboldt			Market
PG&E	HUMBPP_1_UNITS3	31180	HUMB_G1	13.8	16.22	4	Humboldt			Market
PG&E	HUMBPP_1_UNITS3	31180	HUMB_G1	13.8	15.85	2	Humboldt			Market
PG&E	HUMBPP_6_UNITS	31182	HUMB_G3	13.8	16.62	8	Humboldt			Market
PG&E	HUMBPP_6_UNITS	31181	HUMB_G2	13.8	16.33	6	Humboldt			Market
PG&E	HUMBPP_6_UNITS	31182	HUMB_G3	13.8	16.33	9	Humboldt			Market
PG&E	HUMBPP_6_UNITS	31181	HUMB_G2	13.8	16.24	7	Humboldt			Market
PG&E	HUMBPP_6_UNITS	31181	HUMB_G2	13.8	16.14	5	Humboldt			Market
PG&E	HUMBPP_6_UNITS	31182	HUMB_G3	13.8	15.95	10	Humboldt			Market
PG&E	HUMBSB_1_QF				0.00		Humboldt		Not modeled Aug NQC	QF/Selfgen
PG&E	KEKAWK_6_UNIT	31166	KEKAWAK	9.1	0.00	1	Humboldt		Aug NQC	Net Seller
PG&E	LAPAC_6_UNIT	31158	LP SAMOA	12.5	0.00	1	Humboldt			Market
PG&E	LOWGAP_1_SUPHR				0.00		Humboldt		Not modeled Aug NQC	Market
PG&E	PACLUM_6_UNIT	31152	PAC.LUMB	13.8	5.82	1	Humboldt		Aug NQC	Net Seller
PG&E	PACLUM_6_UNIT	31152	PAC.LUMB	13.8	5.82	2	Humboldt		Aug NQC	Net Seller
PG&E	PACLUM_6_UNIT	31153	PAC.LUMB	2.4	3.49	3	Humboldt		Aug NQC	Net Seller

Attachment A - List of physical resources by PTO, local area and market ID

PG&E	ZZZZ_BULKE_6_BLUEL K	31156	BLUELKPP	12.5	0.00	1	Humboldt		Retired	Market
PG&E	7STDRD_1_SOLAR1	35065	7STNDRD_1	21	5.40	FW	Kern	South Kern PP, Westpark, Kern Oil	Aug NQC	Solar
PG&E	ADOBEE_1_SOLAR	35021	Q622B	34.5	5.40	1	Kern	South Kern PP	Aug NQC	Solar
PG&E	BDGRCK_1_UNITS	35029	BADGERCK	13.8	40.20	1	Kern	South Kern PP	Aug NQC	Net Seller
PG&E	BEARMT_1_UNIT	35066	PSE-BEAR	13.8	44.00	1	Kern	South Kern PP, Westpark	Aug NQC	Net Seller
PG&E	BKRFLD_2_SOLAR1				0.37		Kern	South Kern PP	Not modeled Aug NQC	Solar
PG&E	DEXZEL_1_UNIT	35024	DEXEL +	13.8	17.78	1	Kern	South Kern PP, Westpark, Kern Oil	Aug NQC	Net Seller
PG&E	DISCOV_1_CHEVRN	35062	DISCOVERY	13.8	2.58	1	Kern	South Kern PP, Westpark, Kern Oil	Aug NQC	QF/Selfgen
PG&E	DOUBLC_1_UNITS	35023	DOUBLE C	13.8	49.50	1	Kern	South Kern PP	Aug NQC	Net Seller
PG&E	KERNFT_1_UNITS	35026	KERNFRNT	9.11	48.60	1	Kern	South Kern PP	Aug NQC	Net Seller
PG&E	LAMONT_1_SOLAR1	35019	REGULUS	0.4	16.20	1	Kern	South Kern PP, Kern PWR-Tevis	Aug NQC	Solar
PG&E	LAMONT_1_SOLAR2	35092	Q744G4	0.38	5.40	1	Kern	South Kern PP, Kern PWR-Tevis	Aug NQC	Solar
PG&E	LAMONT_1_SOLAR3	35087	Q744G3	0.4	4.05	3	Kern	South Kern PP, Kern PWR-Tevis	Aug NQC	Solar
PG&E	LAMONT_1_SOLAR4	35059	Q744G2	0.4	21.38	2	Kern	South Kern PP, Kern PWR-Tevis	Aug NQC	Solar
PG&E	LAMONT_1_SOLAR5	35054	Q744G1	0.4	4.50	1	Kern	South Kern PP, Kern PWR-Tevis	Aug NQC	Solar
PG&E	LIVOAK_1_UNIT 1	35058	PSE-LVOK	9.1	42.50	1	Kern	South Kern PP, Westpark, Kern Oil	Aug NQC	Net Seller
PG&E	MAGUND_1_BKISR1				0.27		Kern	South Kern PP, Westpark, Kern Oil	Not modeled Aug NQC	Solar
PG&E	MAGUND_1_BKSSR2				1.42		Kern	South Kern PP, Westpark, Kern Oil	Not modeled Aug NQC	Solar
PG&E	MTNPOS_1_UNIT	35036	MT POSO	13.8	34.35	1	Kern	South Kern PP, Westpark, Kern Oil	Aug NQC	Net Seller

Attachment A - List of physical resources by PTO, local area and market ID

PG&E	OLDRIV_6_BIOGAS				1.69		Kern	South Kern PP, Kern 70 kV	Not modeled Aug NQC	Market
PG&E	OLDRIV_6_CESDBM				0.90		Kern	South Kern PP, Kern 70 kV	Not modeled Aug NQC	Market
PG&E	OLDRIV_6_LKVBM1				0.91		Kern	South Kern PP, Kern 70 kV	Not modeled Aug NQC	Market
PG&E	OLDRV1_6_SOLAR	35091	OLD_RVR1	12.5	5.40	1	Kern	South Kern PP, Kern 70 kV	Aug NQC	Solar
PG&E	SIERRA_1_UNITS	35027	HISIERRA	9.11	49.57	1	Kern	South Kern PP	Aug NQC	Market
PG&E	SKERN_6_SOLAR1	35089	S_KERN	0.48	5.40	1	Kern	South Kern PP, Kern 70 kV	Aug NQC	Solar
PG&E	SKERN_6_SOLAR2	36556 3	Q885	0.36	2.70	1	Kern	South Kern PP, Kern 70 kV	Aug NQC	Solar
PG&E	VEDDER_1_SEKERN	35046	SEKR	9.11	2.19	1	Kern	South Kern PP, Westpark, Kern Oil	Aug NQC	QF/Selfgen
PG&E	ZZZZZ_KRNCNY_6_UNIT	35018	KERNCNYN	11	0.00	1	Kern	South Kern PP, Kern 70 kV	Aug NQC	Market
PG&E	ZZZZZ_OILDAL_1_UNIT 1	35028	OILDALE	9.11	0.00	RT	Kern	South Kern PP, Westpark, Kern Oil	Retired	Net Seller
PG&E	ZZZZZ_RIOBRV_6_UNIT 1	35020	RIOBRAVO	9.1	0.00	1	Kern	South Kern PP, Kern 70 kV	Aug NQC	Market
PG&E	ZZZZZ_ULTOGL_1_POSO	35035	ULTR PWR	9.11	0.00	1	Kern	South Kern PP, Westpark, Kern Oil	Retired	QF/Selfgen
PG&E	ADLIN_1_UNITS	31435	GEO.ENGY	9.1	8.00	1	NCNB	Eagle Rock, Fulton		Market
PG&E	ADLIN_1_UNITS	31435	GEO.ENGY	9.1	8.00	2	NCNB	Eagle Rock, Fulton		Market
PG&E	CLOVDL_1_SOLAR				0.41		NCNB	Eagle Rock, Fulton	Not modeled Aug NQC	Solar
PG&E	CSTOGA_6_LNDFIL				0.00		NCNB	Fulton	Not modeled Energy Only	Market
PG&E	FULTON_1_QF				0.06		NCNB	Fulton	Not modeled Aug NQC	QF/Selfgen
PG&E	GEYS11_7_UNIT11	31412	GEYSER11	13.8	68.00	1	NCNB	Eagle Rock, Fulton		Market
PG&E	GEYS12_7_UNIT12	31414	GEYSER12	13.8	50.00	1	NCNB	Fulton		Market
PG&E	GEYS13_7_UNIT13	31416	GEYSER13	13.8	56.00	1	NCNB			Market
PG&E	GEYS14_7_UNIT14	31418	GEYSER14	13.8	50.00	1	NCNB	Fulton		Market

Attachment A - List of physical resources by PTO, local area and market ID

PG&E	GEYS16_7_UNIT16	31420	GEYSER16	13.8	49.00	1	NCNB	Fulton		Market
PG&E	GEYS17_2_BOTRCK				0.00	1	NCNB	Fulton		Market
PG&E	GEYS17_7_UNIT17	31422	GEYSER17	13.8	56.00	1	NCNB	Fulton		Market
PG&E	GEYS18_7_UNIT18	31424	GEYSER18	13.8	45.00	1	NCNB			Market
PG&E	GEYS20_7_UNIT20	31426	GEYSER20	13.8	40.00	1	NCNB			Market
PG&E	GYS5X6_7_UNITS	31406	GEYSR5-6	13.8	42.50	1	NCNB	Eagle Rock, Fulton		Market
PG&E	GYS5X6_7_UNITS	31406	GEYSR5-6	13.8	42.50	2	NCNB	Eagle Rock, Fulton		Market
PG&E	GYS7X8_7_UNITS	31408	GEYSER78	13.8	38.00	1	NCNB	Eagle Rock, Fulton		Market
PG&E	GYS7X8_7_UNITS	31408	GEYSER78	13.8	38.00	2	NCNB	Eagle Rock, Fulton		Market
PG&E	GYSRVL_7_WSPRNG				1.48		NCNB	Fulton	Not modeled Aug NQC	QF/Selfgen
PG&E	HILAND_7_YOLOWD				0.00		NCNB	Eagle Rock, Fulton	Not Modeled. Energy Only	Market
PG&E	IGNACO_1_QF				0.01		NCNB		Not modeled Aug NQC	QF/Selfgen
PG&E	INDVLY_1_UNITS	31436	INDIAN V	9.1	0.79	1	NCNB	Eagle Rock, Fulton	Aug NQC	Net Seller
PG&E	MONTPH_7_UNITS	32700	MONTICLO	9.1	3.11	1	NCNB	Fulton	Aug NQC	Market
PG&E	MONTPH_7_UNITS	32700	MONTICLO	9.1	3.11	2	NCNB	Fulton	Aug NQC	Market
PG&E	MONTPH_7_UNITS	32700	MONTICLO	9.1	0.93	3	NCNB	Fulton	Aug NQC	Market
PG&E	NCPA_7_GP1UN1	38106	NCPA1GY1	13.8	31.00	1	NCNB		Aug NQC	MUNI
PG&E	NCPA_7_GP1UN2	38108	NCPA1GY2	13.8	28.00	1	NCNB		Aug NQC	MUNI
PG&E	NCPA_7_GP2UN3	38110	NCPA2GY1	13.8	0.00	1	NCNB	Fulton	Aug NQC	MUNI
PG&E	NCPA_7_GP2UN4	38112	NCPA2GY2	13.8	52.73	1	NCNB	Fulton	Aug NQC	MUNI
PG&E	NOVATO_6_LNDFL				3.56		NCNB		Not modeled Aug NQC	Market
PG&E	POTTER_6_UNITS	31433	POTTRVLY	2.4	1.32	1	NCNB	Eagle Rock, Fulton	Aug NQC	Market
PG&E	POTTER_6_UNITS	31433	POTTRVLY	2.4	0.60	3	NCNB	Eagle Rock, Fulton	Aug NQC	Market
PG&E	POTTER_6_UNITS	31433	POTTRVLY	2.4	0.60	4	NCNB	Eagle Rock, Fulton	Aug NQC	Market
PG&E	POTTER_7_VECINO				0.01		NCNB	Eagle Rock, Fulton	Not modeled Aug NQC	QF/Selfgen
PG&E	SANTFG_7_UNITS	31400	SANTA FE	13.8	31.50	1	NCNB			Market
PG&E	SANTFG_7_UNITS	31400	SANTA FE	13.8	31.50	2	NCNB			Market

Attachment A - List of physical resources by PTO, local area and market ID

PG&E	SMUDGO_7_UNIT 1	31430	SMUDGE01	13.8	47.00	1	NCNB			Market
PG&E	SNMALF_6_UNITS	31446	SONMA LF	9.1	3.12	1	NCNB	Fulton	Aug NQC	QF/Selfgen
PG&E	UKIAH_7_LAKEMN	38020	CITY UKH	115	1.21	2	NCNB	Eagle Rock, Fulton	Aug NQC	MUNI
PG&E	UKIAH_7_LAKEMN	38020	CITY UKH	115	0.49	1	NCNB	Eagle Rock, Fulton	Aug NQC	MUNI
PG&E	ZZZZZ_BEARCN_2_UNIT S	31402	BEAR CAN	13.8	0.00	1	NCNB	Fulton	Retired	Market
PG&E	ZZZZZ_BEARCN_2_UNIT S	31402	BEAR CAN	13.8	0.00	2	NCNB	Fulton	Retired	Market
PG&E	ZZZZZ_WDFRDF_2_UNIT S	31404	WEST FOR	13.8	0.00	1	NCNB	Fulton		Market
PG&E	ZZZZZ_WDFRDF_2_UNIT S	31404	WEST FOR	13.8	0.00	2	NCNB	Fulton		Market
PG&E	ZZZZZZ_GEYS17_2_BOT RCK	31421	BOTTLERK	13.8	0.00	1	NCNB	Fulton	Retired	Market
PG&E	ALLGNY_6_HYDRO1				0.03		Sierra		Not modeled Aug NQC	Market
PG&E	APLHIL_1_SLABCK				0.00	1	Sierra	South of Rio Oso, South of Palermo	Not modeled Energy Only	Market
PG&E	BANGOR_6_HYDRO				1.00		Sierra		Not modeled Aug NQC	Market
PG&E	BELDEN_7_UNIT 1	31784	BELDEN	13.8	119.00	1	Sierra	South of Palermo	Aug NQC	Market
PG&E	BIOMAS_1_UNIT 1	32156	WOODLAND	9.11	24.31	1	Sierra	Drum-Rio Oso, South of Palermo	Aug NQC	Net Seller
PG&E	BNNIEN_7_ALTAPH	32376	BONNIE N	60	0.68		Sierra	Placer, Gold Hill-Drum, Drum-Rio Oso, South of Rio Oso, South of Palermo	Not modeled Aug NQC	Market
PG&E	BOGUE_1_UNITA1	32451	FREC	13.8	47.60	1	Sierra	Bogue, Drum-Rio Oso	Aug NQC	Market
PG&E	BOWMN_6_HYDRO	32480	BOWMAN	9.11	2.54	1	Sierra	Drum-Rio Oso, South of Palermo	Aug NQC	MUNI
PG&E	BUCKCK_2_HYDRO				0.04		Sierra	South of Palermo	Not modeled Aug NQC	Market
PG&E	BUCKCK_7_OAKFLT				1.30		Sierra	South of Palermo	Not modeled Aug NQC	Market
PG&E	BUCKCK_7_PL1X2	31820	BCKS CRK	11	30.63	1	Sierra	South of Palermo	Aug NQC	Market

Attachment A - List of physical resources by PTO, local area and market ID

PG&E	BUCKCK_7_PL1X2	31820	BCKS CRK	11	26.62	2	Sierra	South of Palermo	Aug NQC	Market
PG&E	CAMPFW_7_FARWST	32470	CMP.FARW	9.11	2.90	1	Sierra		Aug NQC	MUNI
PG&E	CHICPK_7_UNIT 1	32462	CHI.PARK	11.5	42.00	1	Sierra	Placer, Gold Hill-Drum, Drum-Rio Oso, South of Rio Oso, South of Palermo	Aug NQC	MUNI
PG&E	COLGAT_7_UNIT 1	32450	COLGATE1	13.8	161.65	1	Sierra		Aug NQC	MUNI
PG&E	COLGAT_7_UNIT 2	32452	COLGATE2	13.8	161.68	1	Sierra		Aug NQC	MUNI
PG&E	CRESTA_7_PL1X2	31812	CRESTA	11.5	35.54	2	Sierra	South of Palermo	Aug NQC	Market
PG&E	CRESTA_7_PL1X2	31812	CRESTA	11.5	34.86	1	Sierra	South of Palermo	Aug NQC	Market
PG&E	DAVIS_1_SOLAR1				0.00		Sierra	Drum-Rio Oso, South of Palermo	Not modeled Aug NQC	Solar
PG&E	DAVIS_1_SOLAR2				0.00		Sierra	Drum-Rio Oso, South of Palermo	Not modeled Aug NQC	Solar
PG&E	DAVIS_7_MNMETH				1.76		Sierra	Drum-Rio Oso, South of Palermo	Not modeled Aug NQC	Market
PG&E	DEADCK_1_UNIT	31862	DEADWOOD	9.11	0.00	1	Sierra	Drum-Rio Oso	Aug NQC	MUNI
PG&E	DEERCR_6_UNIT 1	32474	DEER CRK	9.11	2.98	1	Sierra	Drum-Rio Oso, South of Palermo	Aug NQC	Market
PG&E	DRUM_7_PL1X2	32504	DRUM 1-2	6.6	13.00	1	Sierra	Drum-Rio Oso, South of Palermo	Aug NQC	Market
PG&E	DRUM_7_PL1X2	32504	DRUM 1-2	6.6	13.00	2	Sierra	Drum-Rio Oso, South of Palermo	Aug NQC	Market
PG&E	DRUM_7_PL3X4	32506	DRUM 3-4	6.6	15.64	2	Sierra	Drum-Rio Oso, South of Palermo	Aug NQC	Market
PG&E	DRUM_7_PL3X4	32506	DRUM 3-4	6.6	13.26	1	Sierra	Drum-Rio Oso, South of Palermo	Aug NQC	Market
PG&E	DRUM_7_UNIT 5	32454	DRUM 5	13.8	50.00	1	Sierra	Drum-Rio Oso, South of Palermo	Aug NQC	Market
PG&E	DUTCH1_7_UNIT 1	32464	DTCHFLT1	11	22.00	1	Sierra	Placer, Gold Hill-Drum, Drum-Rio Oso, South of Rio Oso, South of Palermo	Aug NQC	Market
PG&E	DUTCH2_7_UNIT 1	32502	DTCHFLT2	6.9	26.00	1	Sierra	Drum-Rio Oso, South of Palermo	Aug NQC	MUNI

Attachment A - List of physical resources by PTO, local area and market ID

PG&E	ELDORO_7_UNIT 1	32513	ELDRADO1	21.6	11.00	1	Sierra	Gold Hill-Drum, South of Rio Oso, South of Palermo		Market
PG&E	ELDORO_7_UNIT 2	32514	ELDRADO2	21.6	11.00	1	Sierra	Gold Hill-Drum, South of Rio Oso, South of Palermo		Market
PG&E	FMEADO_6_HELLHL	32486	HELLHOLE	9.11	0.43	1	Sierra	South of Rio Oso, South of Palermo	Aug NQC	MUNI
PG&E	FMEADO_7_UNIT	32508	FRNCH MD	4.2	16.00	1	Sierra	South of Rio Oso, South of Palermo	Aug NQC	MUNI
PG&E	FORBST_7_UNIT 1	31814	FORBSTWN	11.5	37.50	1	Sierra	Drum-Rio Oso	Aug NQC	MUNI
PG&E	GRIDLY_6_SOLAR	38054	GRIDLEY	60	0.00	1	Sierra	Pease	Energy Only	Solar
PG&E	GRNLF2_1_UNIT	32492	GRNLEAF2	13.8	38.99	1	Sierra	Pease, Drum-Rio Oso	Aug NQC	QF/Selfgen
PG&E	HALSEY_6_UNIT	32478	HALSEY F	9.11	13.50	1	Sierra	Placer, Gold Hill- Drum, Drum-Rio Oso, South of Rio Oso, South of Palermo	Aug NQC	Market
PG&E	HAYPRS_6_QFUNTS	32488	HAYPRES+	9.11	0.05	2	Sierra	Drum-Rio Oso, South of Palermo	Aug NQC	QF/Selfgen
PG&E	HAYPRS_6_QFUNTS	32488	HAYPRES+	9.11	0.04	1	Sierra	Drum-Rio Oso, South of Palermo	Aug NQC	QF/Selfgen
PG&E	HIGGNS_1_COMBIE				0.22		Sierra	Drum-Rio Oso, South of Rio Oso, South of Palermo	Not modeled Aug NQC	Market
PG&E	HIGGNS_7_QFUNTS				0.24		Sierra	Drum-Rio Oso, South of Rio Oso, South of Palermo	Not modeled Aug NQC	QF/Selfgen
PG&E	KELYRG_6_UNIT	31834	KELLYRDG	9.11	11.00	1	Sierra	Drum-Rio Oso	Aug NQC	MUNI
PG&E	LIVEOK_6_SOLAR				0.14		Sierra	Pease	Not modeled Aug NQC	Solar
PG&E	LODIEC_2_PL1X2	38123	LODI CT1	18	199.0 3	1	Sierra	South of Rio Oso, South of Palermo		MUNI
PG&E	LODIEC_2_PL1X2	38124	LODI ST1	18	103.5 5	1	Sierra	South of Rio Oso, South of Palermo		MUNI
PG&E	MDFKRL_2_PROJECT	32458	RALSTON	13.8	82.13	1	Sierra	South of Rio Oso, South of Palermo	Aug NQC	MUNI
PG&E	MDFKRL_2_PROJECT	32456	MIDLFORK	13.8	63.94	1	Sierra	South of Rio Oso, South of Palermo	Aug NQC	MUNI

Attachment A - List of physical resources by PTO, local area and market ID

PG&E	MDFKRL_2_PROJECT	32456	MIDLFORK	13.8	63.94	2	Sierra	South of Rio Oso, South of Palermo	Aug NQC	MUNI
PG&E	NAROW1_2_UNIT	32466	NARROWS1	9.1	12.00	1	Sierra		Aug NQC	Market
PG&E	NAROW2_2_UNIT	32468	NARROWS2	9.1	28.51	1	Sierra		Aug NQC	MUNI
PG&E	NWCSTL_7_UNIT 1	32460	NEWCASTLE	13.2	0.51	1	Sierra	Placer, Gold Hill- Drum, Drum-Rio Oso, South of Rio Oso, South of Palermo	Aug NQC	Market
PG&E	OROVIL_6_UNIT	31888	OROVILLE	9.11	7.50	1	Sierra	Drum-Rio Oso	Aug NQC	Market
PG&E	OXBOW_6_DRUM	32484	OXBOW F	9.11	3.62	1	Sierra	Drum-Rio Oso, South of Palermo	Aug NQC	MUNI
PG&E	PLACVL_1_CHILIB	32510	CHILIBAR	4.2	8.40	1	Sierra	Gold Hill-Drum, South of Rio Oso, South of Palermo	Aug NQC	Market
PG&E	PLACVL_1_RCKCRE				1.20		Sierra	South of Rio Oso, South of Palermo	Not modeled Aug NQC	Market
PG&E	PLSNTG_7_LNCLND	32408	PLSNT GR	60	3.09		Sierra	Drum-Rio Oso, South of Rio Oso, South of Palermo	Not modeled Aug NQC	Market
PG&E	POEPH_7_UNIT 1	31790	POE 1	13.8	60.00	1	Sierra	South of Palermo	Aug NQC	Market
PG&E	POEPH_7_UNIT 2	31792	POE 2	13.8	60.00	1	Sierra	South of Palermo	Aug NQC	Market
PG&E	RCKCRK_7_UNIT 1	31786	ROCK CK1	13.8	57.00	1	Sierra	South of Palermo	Aug NQC	Market
PG&E	RCKCRK_7_UNIT 2	31788	ROCK CK2	13.8	56.90	1	Sierra	South of Palermo	Aug NQC	Market
PG&E	RIOOSO_1_QF				1.15		Sierra	Drum-Rio Oso, South of Palermo	Not modeled Aug NQC	QF/Selfgen
PG&E	ROLLIN_6_UNIT	32476	ROLLINSF	9.11	13.50	1	Sierra	Drum-Rio Oso, South of Palermo	Aug NQC	MUNI
PG&E	SLYCRK_1_UNIT 1	31832	SLY.CR.	9.11	13.00	1	Sierra	Drum-Rio Oso	Aug NQC	MUNI
PG&E	SPAULD_6_UNIT 3	32472	SPAULDG	9.11	1.59	3	Sierra	Drum-Rio Oso, South of Palermo	Aug NQC	Market
PG&E	SPAULD_6_UNIT12	32472	SPAULDG	9.11	7.00	1	Sierra	Drum-Rio Oso, South of Palermo	Aug NQC	Market
PG&E	SPAULD_6_UNIT12	32472	SPAULDG	9.11	4.40	2	Sierra	Drum-Rio Oso, South of Palermo	Aug NQC	Market
PG&E	SPI LI_2_UNIT 1	32498	SPILINCF	12.5	9.93	1	Sierra	Drum-Rio Oso, South of Rio Oso, South of Palermo	Aug NQC	Net Seller
PG&E	STIGCT_2_LODI	38114	Stig CC	13.8	49.50	1	Sierra	South of Rio Oso, South of Palermo		MUNI

Attachment A - List of physical resources by PTO, local area and market ID

PG&E	ULTRCK_2_UNIT	32500	ULTR RCK	9.11	22.83	1	Sierra	Drum-Rio Oso, South of Rio Oso, South of Palermo	Aug NQC	Market
PG&E	WDLEAF_7_UNIT 1	31794	WOODLEAF	13.8	60.00	1	Sierra	Drum-Rio Oso	Aug NQC	MUNI
PG&E	WHEATL_6_LNDFIL	32350	WHEATLND	60	3.55		Sierra		Not modeled Aug NQC	Market
PG&E	WISE_1_UNIT 1	32512	WISE	12	14.50	1	Sierra	Placer, Gold Hill- Drum, Drum-Rio Oso, South of Rio Oso, South of Palermo	Aug NQC	Market
PG&E	WISE_1_UNIT 2	32512	WISE	12	3.20	1	Sierra	Placer, Gold Hill- Drum, Drum-Rio Oso, South of Rio Oso, South of Palermo	Aug NQC	Market
PG&E	YUBACT_1_SUNSWT	32494	YUBA CTY	9.11	49.97	1	Sierra	Pease, Drum-Rio Oso	Aug NQC	Net Seller
PG&E	YUBACT_6_UNITA1	32496	YCEC	13.8	47.60	1	Sierra	Pease, Drum-Rio Oso		Market
PG&E	ZZ_NA	32162	RIV.DLTA	9.11	0.00	1	Sierra	Drum-Rio Oso, South of Palermo	No NQC - hist. data	QF/Selfgen
PG&E	ZZ_UCDAVS_1_UNIT	32166	UC DAVIS	9.11	0.00	RN	Sierra	Drum-Rio Oso, South of Palermo	No NQC - hist. data	QF/Selfgen
PG&E	ZZZ_New Unit	36593 6	Q653FSPV	0.48	2.46	1	Sierra	Drum-Rio Oso, South of Palermo	No NQC - est. data	Solar
PG&E	ZZZ_New Unit	36594 0	Q653FSPV	0.48	2.46	2	Sierra	Drum-Rio Oso, South of Palermo	No NQC - est. data	Solar
PG&E	ZZZ_New Unit	36593 8	Q653FC6B	0.48	0.00	2	Sierra	Drum-Rio Oso, South of Palermo	No NQC - est. data	Battery
PG&E	ZZZZ_GOLDHL_1_QF				0.00		Sierra	South of Rio Oso, South of Palermo	Not modeled	QF/Selfgen
PG&E	ZZZZ_GRNLF1_1_UNITS	32490	GRNLEAF1	13.8	0.00	1	Sierra	Bogue, Drum-Rio Oso	Retired	Market
PG&E	ZZZZ_GRNLF1_1_UNITS	32491	GRNLEAF1	13.8	0.00	2	Sierra	Bogue, Drum-Rio Oso	Retired	Market
PG&E	ZZZZ_KANAKA_1_UNIT				0.00		Sierra	Drum-Rio Oso	Retired	MUNI
PG&E	ZZZZ_PACORO_6_UNIT	31890	PO POWER	9.11	0.00	1	Sierra	Drum-Rio Oso	Retired	QF/Selfgen

Attachment A - List of physical resources by PTO, local area and market ID

PG&E	ZZZZ_PACORO_6_UNIT	31890	PO POWER	9.11	0.00	2	Sierra	Drum-Rio Oso	Retired	QF/Selfgen
PG&E	BEARDS_7_UNIT 1	34074	BEARDSLY	6.9	8.36	1	Stockton	Tesla-Bellota, Stanislaus	Aug NQC	MUNI
PG&E	CAMCHE_1_PL1X3	33850	CAMANCHE	4.2	0.92	1	Stockton	Tesla-Bellota	Aug NQC	MUNI
PG&E	CAMCHE_1_PL1X3	33850	CAMANCHE	4.2	0.92	2	Stockton	Tesla-Bellota	Aug NQC	MUNI
PG&E	CAMCHE_1_PL1X3	33850	CAMANCHE	4.2	0.92	3	Stockton	Tesla-Bellota	Aug NQC	MUNI
PG&E	CRWCK_1_SOLAR1	34051	Q539	34.5	0.00	1	Stockton	Tesla-Bellota	Energy Only	Solar
PG&E	DONNLS_7_UNIT	34058	DONNELLS	13.8	72.00	1	Stockton	Tesla-Bellota, Stanislaus	Aug NQC	MUNI
PG&E	FROGTN_1_UTICAA				1.40		Stockton	Tesla-Bellota, Stanislaus	Not Modeled Aug NQC	Market
PG&E	FROGTN_1_UTICAM				2.37		Stockton	Tesla-Bellota, Stanislaus	Not Modeled Aug NQC	Market
PG&E	LOCKFD_1_BEARCK				0.41		Stockton	Tesla-Bellota	Not Modeled Aug NQC	Solar
PG&E	LOCKFD_1_KSOLAR				0.27		Stockton	Tesla-Bellota	Not Modeled Aug NQC	Solar
PG&E	LODI25_2_UNIT 1	38120	LODI25CT	9.11	23.80	1	Stockton	Lockeford		MUNI
PG&E	MANTEC_1_ML1SR1				0.00		Stockton	Tesla-Bellota	Not modeled Energy Only	Solar
PG&E	PEORIA_1_SOLAR				0.41		Stockton	Tesla-Bellota, Stanislaus	Not modeled Aug NQC	Solar
PG&E	PHOENX_1_UNIT				0.84		Stockton	Tesla-Bellota, Stanislaus	Not modeled Aug NQC	Market
PG&E	SCHLTE_1_PL1X3	33811	GWFTRCY3	13.8	138.1 1	1	Stockton	Tesla-Bellota		Market
PG&E	SCHLTE_1_PL1X3	33805	GWFTRCY1	13.8	85.70	1	Stockton	Tesla-Bellota		Market
PG&E	SCHLTE_1_PL1X3	33807	GWFTRCY2	13.8	85.70	1	Stockton	Tesla-Bellota		Market
PG&E	SMPRIP_1_SMPSON	33810	SP CMPNY	13.8	46.05	1	Stockton	Tesla-Bellota	Aug NQC	Market
PG&E	SNDBAR_7_UNIT 1	34060	SANDBAR	13.8	12.88	1	Stockton	Tesla-Bellota, Stanislaus	Aug NQC	MUNI
PG&E	SPIFBD_1_PL1X2	34055	SPISONORA	13.8	5.67	1	Stockton	Tesla-Bellota, Stanislaus	Aug NQC	Market
PG&E	SPRGAP_1_UNIT 1	34078	SPRNG GP	6	0.01	1	Stockton	Tesla-Bellota, Stanislaus	Aug NQC	Market
PG&E	STANIS_7_UNIT 1	34062	STANISLS	13.8	91.00	1	Stockton	Tesla-Bellota, Stanislaus	Aug NQC	Market
PG&E	STNRES_1_UNIT	34056	STNSLSRP	13.8	18.26	1	Stockton	Tesla-Bellota	Aug NQC	Net Seller
PG&E	TULLCK_7_UNITS	34076	TULLOCH	6.9	7.41	2	Stockton	Tesla-Bellota	Aug NQC	MUNI

Attachment A - List of physical resources by PTO, local area and market ID

PG&E	TULLCK_7_UNITS	34076	TULLOCH	6.9	6.58	1	Stockton	Tesla-Bellota	Aug NQC	MUNI
PG&E	TULLCK_7_UNITS	34076	TULLOCH	6.9	4.86	3	Stockton	Tesla-Bellota	Aug NQC	MUNI
PG&E	ULTPCH_1_UNIT 1	34050	CH.STN.	13.8	16.19	1	Stockton	Tesla-Bellota, Stanislaus	Aug NQC	Market
PG&E	VLYHOM_7_SSID				0.65		Stockton	Tesla-Bellota, Stanislaus	Not modeled Aug NQC	MUNI
PG&E	ZZZ_New Unit	36568 4	Q1103		10.80	1	Stockton	Tesla-Bellota	No NQC - est. data	Solar
PG&E	ZZZ_New Unit	34053	Q539		0.00	1	Stockton	Tesla-Bellota	Energy Only	Solar
PG&E	ZZZ_New Unit	36555 6	SAFEWAYB		0.00	RN	Stockton	Tesla-Bellota	Energy Only	Market
PG&E	ZZZZ_FROGTN_7_UTIC A				0.00		Stockton	Tesla-Bellota, Stanislaus	Not modeled Energy Only	Market
PG&E	ZZZZ_STOKCG_1_UNIT 1	33814	INGREDION	12.5	0.00	RN	Stockton	Tesla-Bellota	Retired	QF/Selfgen
PG&E	ZZZZZ_NA	33830	GEN.MILL	9.11	0.00	1	Stockton	Lockeford	Retired	QF/Selfgen
PG&E	ZZZZZZ_SANJOA_1_UNI T 1	33808	SJ COGEN	13.8	0.00	1	Stockton	Tesla-Bellota	Retired	QF/Selfgen
PG&E	ZZZZZZ_THMENG_1_UN IT 1	33806	TH.E.DV.	13.8	0.00	1	Stockton	Tesla-Bellota	Retired	Net Seller
SCE	ACACIA_6_SOLAR	29878	ACACIA_G	0.48	5.40	EQ	BC/Ventura		Aug NQC	Solar
SCE	ALAMO_6_UNIT	25653	ALAMO SC	13.8	11.36	1	BC/Ventura		Aug NQC	MUNI
SCE	BGSKYN_2_AS2SR1	29774	ANTLOP2_G1	0.42	28.35	EQ	BC/Ventura		Aug NQC	Solar
SCE	BGSKYN_2_ASPSR2				27.00		BC/Ventura		Aug NQC	Solar
SCE	BGSKYN_2_BS3SR3				5.40		BC/Ventura		Aug NQC	Solar
SCE	BIGCRK_2_EXESWD	24317	MAMOTH1G	13.8	92.02	1	BC/Ventura	Rector, Vestal	Aug NQC	Market
SCE	BIGCRK_2_EXESWD	24318	MAMOTH2G	13.8	92.02	2	BC/Ventura	Rector, Vestal	Aug NQC	Market
SCE	BIGCRK_2_EXESWD	24308	B CRK2-1	13.8	51.18	2	BC/Ventura	Rector, Vestal	Aug NQC	Market
SCE	BIGCRK_2_EXESWD	24308	B CRK2-1	13.8	49.99	1	BC/Ventura	Rector, Vestal	Aug NQC	Market
SCE	BIGCRK_2_EXESWD	24314	B CRK 4	11.5	49.80	42	BC/Ventura	Rector, Vestal	Aug NQC	Market
SCE	BIGCRK_2_EXESWD	24314	B CRK 4	11.5	49.60	41	BC/Ventura	Rector, Vestal	Aug NQC	Market
SCE	BIGCRK_2_EXESWD	24315	B CRK 8	13.8	43.30	82	BC/Ventura	Rector, Vestal	Aug NQC	Market
SCE	BIGCRK_2_EXESWD	24313	B CRK3-3	13.8	35.92	5	BC/Ventura	Rector, Vestal	Aug NQC	Market
SCE	BIGCRK_2_EXESWD	24312	B CRK3-2	13.8	35.43	4	BC/Ventura	Rector, Vestal	Aug NQC	Market
SCE	BIGCRK_2_EXESWD	24311	B CRK3-1	13.8	34.44	1	BC/Ventura	Rector, Vestal	Aug NQC	Market
SCE	BIGCRK_2_EXESWD	24312	B CRK3-2	13.8	34.44	3	BC/Ventura	Rector, Vestal	Aug NQC	Market
SCE	BIGCRK_2_EXESWD	24311	B CRK3-1	13.8	33.46	2	BC/Ventura	Rector, Vestal	Aug NQC	Market
SCE	BIGCRK_2_EXESWD	24307	B CRK1-2	13.8	30.71	4	BC/Ventura	Rector, Vestal	Aug NQC	Market
SCE	BIGCRK_2_EXESWD	24315	B CRK 8	13.8	24.01	81	BC/Ventura	Rector, Vestal	Aug NQC	Market

Attachment A - List of physical resources by PTO, local area and market ID

SCE	BIGCRK_2_EXESWD	24306	B CRK1-1	7.2	21.26	2	BC/Ventura	Rector, Vestal	Aug NQC	Market
SCE	BIGCRK_2_EXESWD	24307	B CRK1-2	13.8	21.26	3	BC/Ventura	Rector, Vestal	Aug NQC	Market
SCE	BIGCRK_2_EXESWD	24306	B CRK1-1	7.2	19.58	1	BC/Ventura	Rector, Vestal	Aug NQC	Market
SCE	BIGCRK_2_EXESWD	24309	B CRK2-2	7.2	19.39	4	BC/Ventura	Rector, Vestal	Aug NQC	Market
SCE	BIGCRK_2_EXESWD	24309	B CRK2-2	7.2	18.40	3	BC/Ventura	Rector, Vestal	Aug NQC	Market
SCE	BIGCRK_2_EXESWD	24310	B CRK2-3	7.2	18.21	6	BC/Ventura	Rector, Vestal	Aug NQC	Market
SCE	BIGCRK_2_EXESWD	24310	B CRK2-3	7.2	16.73	5	BC/Ventura	Rector, Vestal	Aug NQC	Market
SCE	BIGCRK_2_EXESWD	24323	PORTAL	4.8	9.45	1	BC/Ventura	Rector, Vestal	Aug NQC	Market
SCE	BIGCRK_7_DAM7				0.00		BC/Ventura	Rector, Vestal	Not modeled Energy Only	Market
SCE	BIGCRK_7_MAMRES				0.00		BC/Ventura	Rector, Vestal	Not modeled Energy Only	Market
SCE	BIGSKY_2_BSKSR6	29734	BSKY G BC	0.42	5.40	1	BC/Ventura		Aug NQC	Solar
SCE	BIGSKY_2_BSKSR7	29737	BSKY G WABS	0.42	5.40	1	BC/Ventura		Aug NQC	Solar
SCE	BIGSKY_2_BSKSR8	29740	BSKY G ABSR	0.38	5.40	1	BC/Ventura		Aug NQC	Solar
SCE	BIGSKY_2_SOLAR1	29704	BSKY G SMR	0.42	5.40	1	BC/Ventura		Aug NQC	Solar
SCE	BIGSKY_2_SOLAR2	29744	BSKY_G_ESC	0.42	34.41	1	BC/Ventura		Aug NQC	Solar
SCE	BIGSKY_2_SOLAR3	29725	BSKY_G_BD	0.42	5.40	1	BC/Ventura		Aug NQC	Solar
SCE	BIGSKY_2_SOLAR4	29701	BSKY_G_BA	0.42	17.26	1	BC/Ventura		Aug NQC	Solar
SCE	BIGSKY_2_SOLAR5	29731	BSKY_G_BB	0.42	1.35	1	BC/Ventura		Aug NQC	Solar
SCE	BIGSKY_2_SOLAR6	29728	BSKY_G_SOL V	0.42	22.95	1	BC/Ventura		Aug NQC	Solar
SCE	BIGSKY_2_SOLAR7	29731	BSKY_G_ADS R	0.42	13.50	1	BC/Ventura		Aug NQC	Solar
SCE	CEDUCR_2_SOLAR1	25049	DUCOR1	0.38 5	0.00	EQ	BC/Ventura	Vestal	Energy Only	Solar
SCE	CEDUCR_2_SOLAR2	25052	DUCOR2	0.38 5	0.00	EQ	BC/Ventura	Vestal	Energy Only	Solar
SCE	CEDUCR_2_SOLAR3	25055	DUCOR3	0.38 5	0.00	EQ	BC/Ventura	Vestal	Energy Only	Solar
SCE	CEDUCR_2_SOLAR4	25058	DUCOR4	0.38 5	0.00	EQ	BC/Ventura	Vestal	Energy Only	Solar
SCE	DELSUR_6_BSOLAR	24411	DELSUR_DIS T	66	0.81	1	BC/Ventura		Aug NQC	Solar
SCE	DELSUR_6_CREST	24411	DELSUR_DIS T	66	0.00		BC/Ventura		Not modeled Energy Only	Market
SCE	DELSUR_6_DRYFRB	24411	DELSUR_DIS T	66	1.35	1	BC/Ventura		Aug NQC	Market

Attachment A - List of physical resources by PTO, local area and market ID

SCE	DELSUR_6_SOLAR1	24411	DELSUR_DIST	66	1.76	2	BC/Ventura		Aug NQC	Solar
SCE	DELSUR_6_SOLAR4	24411	DELSUR_DIST	66	0.00		BC/Ventura		Not modeled Energy Only	Solar
SCE	DELSUR_6_SOLAR5	24411	DELSUR_DIST	66	0.00		BC/Ventura		Not modeled Energy Only	Solar
SCE	EASTWD_7_UNIT	24319	EASTWOOD	13.8	199.00	1	BC/Ventura	Rector, Vestal		Market
SCE	EDMONS_2_NSPIN	25605	EDMON1AP	14.4	16.86	1	BC/Ventura		Pumps	MUNI
SCE	EDMONS_2_NSPIN	25606	EDMON2AP	14.4	16.86	2	BC/Ventura		Pumps	MUNI
SCE	EDMONS_2_NSPIN	25607	EDMON3AP	14.4	16.86	3	BC/Ventura		Pumps	MUNI
SCE	EDMONS_2_NSPIN	25607	EDMON3AP	14.4	16.86	4	BC/Ventura		Pumps	MUNI
SCE	EDMONS_2_NSPIN	25608	EDMON4AP	14.4	16.86	5	BC/Ventura		Pumps	MUNI
SCE	EDMONS_2_NSPIN	25608	EDMON4AP	14.4	16.86	6	BC/Ventura		Pumps	MUNI
SCE	EDMONS_2_NSPIN	25609	EDMON5AP	14.4	16.86	7	BC/Ventura		Pumps	MUNI
SCE	EDMONS_2_NSPIN	25609	EDMON5AP	14.4	16.86	8	BC/Ventura		Pumps	MUNI
SCE	EDMONS_2_NSPIN	25610	EDMON6AP	14.4	16.86	9	BC/Ventura		Pumps	MUNI
SCE	EDMONS_2_NSPIN	25610	EDMON6AP	14.4	16.86	10	BC/Ventura		Pumps	MUNI
SCE	EDMONS_2_NSPIN	25611	EDMON7AP	14.4	16.85	11	BC/Ventura		Pumps	MUNI
SCE	EDMONS_2_NSPIN	25611	EDMON7AP	14.4	16.85	12	BC/Ventura		Pumps	MUNI
SCE	EDMONS_2_NSPIN	25612	EDMON8AP	14.4	16.85	13	BC/Ventura		Pumps	MUNI
SCE	EDMONS_2_NSPIN	25612	EDMON8AP	14.4	16.85	14	BC/Ventura		Pumps	MUNI
SCE	GLDFGR_6_SOLAR1	25079	PRIDE B G	0.64	5.40	1	BC/Ventura		Aug NQC	Solar
SCE	GLDFGR_6_SOLAR2	25169	PRIDE C G	0.64	3.08	1	BC/Ventura		Aug NQC	Solar
SCE	GLOW_6_SOLAR	29896	APPINV	0.42	0.00	EQ	BC/Ventura		Energy Only	Solar
SCE	GOLETA_2_QF	25335	GOLETA_DIST	66	0.04	S1	BC/Ventura	S.Clara, Moorpark, Goleta	Aug NQC	QF/Selfgen
SCE	GOLETA_6_ELLWOD	29004	ELLWOOD	13.8	0.00	1	BC/Ventura	S.Clara, Moorpark, Goleta		Market
SCE	GOLETA_6_EXGEN	24362	EXGEN2	13.8	0.00	G1	BC/Ventura	S.Clara, Moorpark, Goleta	Aug NQC - Currently out of service	QF/Selfgen
SCE	GOLETA_6_EXGEN	24326	EXGEN1	13.8	0.00	S1	BC/Ventura	S.Clara, Moorpark, Goleta	Aug NQC - Currently out of service	QF/Selfgen
SCE	GOLETA_6_GAVOTA	25335	GOLETA_DIST	66	0.00	S1	BC/Ventura	S.Clara, Moorpark, Goleta	Aug NQC	Market

Attachment A - List of physical resources by PTO, local area and market ID

SCE	GOLETA_6_TAJIGS	25335	GOLETA_DIST	66	2.84	S1	BC/Ventura	S.Clara, Moorpark, Goleta	Aug NQC	Market
SCE	LEBECS_2_UNITS	29053	PSTRIAS1	18	173.86	S1	BC/Ventura		Aug NQC	Market
SCE	LEBECS_2_UNITS	29051	PSTRIAG1	18	168.90	G1	BC/Ventura		Aug NQC	Market
SCE	LEBECS_2_UNITS	29052	PSTRIAG2	18	168.90	G2	BC/Ventura		Aug NQC	Market
SCE	LEBECS_2_UNITS	29054	PSTRIAG3	18	168.90	G3	BC/Ventura		Aug NQC	Market
SCE	LEBECS_2_UNITS	29055	PSTRIAS2	18	84.45	S2	BC/Ventura		Aug NQC	Market
SCE	LITLRK_6_GBCSR1	24419	LTLRCK_DIST	66	0.81	AS	BC/Ventura		Aug NQC	Solar
SCE	LITLRK_6_SEPV01	24419	LTLRCK_DIST	66	0.00	AS	BC/Ventura		Energy Only	Market
SCE	LITLRK_6_SOLAR1	24419	LTLRCK_DIST	66	1.35	AS	BC/Ventura		Aug NQC	Solar
SCE	LITLRK_6_SOLAR2	24419	LTLRCK_DIST	66	0.54	AS	BC/Ventura		Aug NQC	Solar
SCE	LITLRK_6_SOLAR3	24419	LTLRCK_DIST	66	0.54	AS	BC/Ventura		Aug NQC	Solar
SCE	LITLRK_6_SOLAR4	24419	LTLRCK_DIST	66	0.81	AS	BC/Ventura		Aug NQC	Solar
SCE	LNCSTR_6_CREST				0.00		BC/Ventura		Not modeled Energy Only	Market
SCE	MNDALY_6_MCGRTH	29306	MCGPKGEN	13.8	47.20	1	BC/Ventura	S.Clara, Moorpark		Market
SCE	MOORPK_2_CALABS	25081	WDT251	13.8	4.57	EQ	BC/Ventura	Moorpark	Aug NQC	Market
SCE	MOORPK_6_QF				0.80		BC/Ventura	Moorpark	Not modeled Aug NQC	Market
SCE	NEENCH_6_SOLAR	29900	ALPINE_G	0.48	17.82	EQ	BC/Ventura		Aug NQC	Solar
SCE	OASIS_6_CREST				0.00		BC/Ventura		Not modeled Energy Only	Market
SCE	OASIS_6_GBDSR4	24421	OASIS_DIST	66	0.81	1	BC/Ventura		Aug NQC	Solar
SCE	OASIS_6_SOLAR1	25095	SOLARISG2	0.2	0.00	EQ	BC/Ventura		Energy Only	Solar
SCE	OASIS_6_SOLAR2	25075	SOLARISG	0.2	5.40	EQ	BC/Ventura		Aug NQC	Solar
SCE	OASIS_6_SOLAR3				0.00		BC/Ventura		Not modeled Energy Only	Solar
SCE	OMAR_2_UNIT 1	24102	OMAR 1G	13.8	70.30	1	BC/Ventura			Net Seller
SCE	OMAR_2_UNIT 2	24103	OMAR 2G	13.8	71.24	2	BC/Ventura			Net Seller
SCE	OMAR_2_UNIT 3	24104	OMAR 3G	13.8	74.03	3	BC/Ventura			Net Seller

Attachment A - List of physical resources by PTO, local area and market ID

SCE	OMAR_2_UNIT 4	24105	OMAR 4G	13.8	81.44	4	BC/Ventura			Net Seller
SCE	ORMOND_7_UNIT 1	24107	ORMOND1G	26	0.00	1	BC/Ventura	Moorpark	Retired by 2025	Market
SCE	ORMOND_7_UNIT 2	24108	ORMOND2G	26	0.00	2	BC/Ventura	Moorpark	Retired by 2025	Market
SCE	OSO_6_NSPIN	25614	OSO A P	13.2	2.25	1	BC/Ventura		Pumps	MUNI
SCE	OSO_6_NSPIN	25614	OSO A P	13.2	2.25	2	BC/Ventura		Pumps	MUNI
SCE	OSO_6_NSPIN	25614	OSO A P	13.2	2.25	3	BC/Ventura		Pumps	MUNI
SCE	OSO_6_NSPIN	25614	OSO A P	13.2	2.25	4	BC/Ventura		Pumps	MUNI
SCE	OSO_6_NSPIN	25615	OSO B P	13.2	2.25	5	BC/Ventura		Pumps	MUNI
SCE	OSO_6_NSPIN	25615	OSO B P	13.2	2.25	6	BC/Ventura		Pumps	MUNI
SCE	OSO_6_NSPIN	25615	OSO B P	13.2	2.25	7	BC/Ventura		Pumps	MUNI
SCE	OSO_6_NSPIN	25615	OSO B P	13.2	2.25	8	BC/Ventura		Pumps	MUNI
SCE	PLAINV_6_BSOLAR	29917	SSOLAR)GR WKS	0.8	0.00	1	BC/Ventura		Energy Only	Solar
SCE	PLAINV_6_DSOLAR	29914	WADR_PV	0.42	2.70	1	BC/Ventura		Aug NQC	Solar
SCE	PLAINV_6_NLRSR1	29921	NLR_INVTR	0.42	0.00	1	BC/Ventura		Aug NQC	Solar
SCE	PLAINV_6_SOLAR3	25089	CNTRL ANT G	0.42	0.00	1	BC/Ventura		Energy Only	Solar
SCE	PLAINV_6_SOLARC	25086	SIRA SOLAR G	0.8	0.00	1	BC/Ventura		Energy Only	Solar
SCE	PMDLET_6_SOLAR1				2.70		BC/Ventura		Not modeled Aug NQC	Solar
SCE	RECTOR_2_CREST	25333	RECTOR_DIS T	66	0.00	S1	BC/Ventura	Rector, Vestal	Aug NQC	Market
SCE	RECTOR_2_KAWEAH	25333	RECTOR_DIS T	66	1.74	S2	BC/Ventura	Rector, Vestal	Aug NQC	Market
SCE	RECTOR_2_KAWH 1	24370	KAWGEN	13.8	0.52	1	BC/Ventura	Rector, Vestal	Aug NQC	Market
SCE	RECTOR_2_QF	25333	RECTOR_DIS T	66	3.94	S1	BC/Ventura	Rector, Vestal	Aug NQC	QF/Selfgen
SCE	RECTOR_2_TFDBM1				0.00		BC/Ventura	Rector, Vestal	Energy Only	Market
SCE	RECTOR_7_TULARE	25333	RECTOR_DIS T	66	0.00	S1	BC/Ventura	Rector, Vestal	Aug NQC	Market
SCE	REDMAN_2_SOLAR	24425	REDMAN_DIS T	66	1.01	AS	BC/Ventura		Aug NQC	Solar
SCE	REDMAN_6_AVSSR1				0.81		BC/Ventura		Aug NQC	Solar
SCE	ROSMND_6_SOLAR	24434	ROSAMOND_ DIS	66	0.81	AS	BC/Ventura		Aug NQC	Solar
SCE	RSMSLR_6_SOLAR1	29984	DAWNGEN	0.8	5.40	EQ	BC/Ventura		Aug NQC	Solar

Attachment A - List of physical resources by PTO, local area and market ID

SCE	RSMSLR_6_SOLAR2	29888	TWILGHTG	0.8	5.40	EQ	BC/Ventura		Aug NQC	Solar
SCE	SAUGUS_6_CREST				0.00		BC/Ventura		Energy Only	Market
SCE	SAUGUS_6_MWDFTH	25336	SAUGUS_MW D	66	5.40	S1	BC/Ventura		Aug NQC	MUNI
SCE	SAUGUS_6_QF	24135	SAUGUS	66	0.70		BC/Ventura		Not modeled Aug NQC	QF/Selfgen
SCE	SAUGUS_7_CHIQCN	24135	SAUGUS	66	5.63		BC/Ventura		Not modeled Aug NQC	Market
SCE	SAUGUS_7_LOPEZ	24135	SAUGUS	66	5.34		BC/Ventura		Not modeled Aug NQC	QF/Selfgen
SCE	SHUTLE_6_CREST	24426	SHUTTLE_DIS T	66	0.00	AS	BC/Ventura		Energy Only	Market
SCE	SNCLRA_2_HOWLNG	25080	SANTACLAR_D IS	13.8	8.72	EQ	BC/Ventura	S.Clara, Moorpark	Aug NQC	Market
SCE	SNCLRA_2_SPRHYD	25080	SANTACLAR_D IS	13.8	0.18	EQ	BC/Ventura	S.Clara, Moorpark	Aug NQC	Market
SCE	SNCLRA_2_UNIT	29952	CAMGEN	13.8	27.50	D1	BC/Ventura	S.Clara, Moorpark	Aug NQC	Market
SCE	SNCLRA_2_UNIT1	24159	WILLAMET	3.8	15.63	D1	BC/Ventura	S.Clara, Moorpark	Aug NQC	Market
SCE	SNCLRA_6_OXGEN	24110	OXGEN	13.8	35.38	D1	BC/Ventura	S.Clara, Moorpark	Aug NQC	QF/Selfgen
SCE	SNCLRA_6_PROCGN	24119	PROCGEN	13.8	45.47	D1	BC/Ventura	S.Clara, Moorpark	Aug NQC	QF/Selfgen
SCE	SNCLRA_6_QF	25080	SANTACLAR_D IS	13.8	0.00	EQ	BC/Ventura	S.Clara, Moorpark	Aug NQC	QF/Selfgen
SCE	SPRGVL_2_CREST	25334	SPRNGVL_DI ST	66	0.00	S1	BC/Ventura	Rector, Vestal	Energy Only	Market
SCE	SPRGVL_2_QF	25334	SPRNGVL_DI ST	66	0.18	S1	BC/Ventura	Rector, Vestal	Aug NQC	QF/Selfgen
SCE	SPRGVL_2_TULE	25334	SPRNGVL_DI ST	66	0.00	S2	BC/Ventura	Rector, Vestal	Aug NQC	Market
SCE	SPRGVL_2_TULESC	25334	SPRNGVL_DI ST	66	0.00	S1	BC/Ventura	Rector, Vestal	Aug NQC	Market
SCE	SUNSHN_2_LNDFL	29954	WDT273	13.6 6	3.17	1	BC/Ventura		Aug NQC	Market
SCE	SUNSHN_2_LNDFL	29954	WDT273	13.6 6	3.17	2	BC/Ventura		Aug NQC	Market
SCE	SUNSHN_2_LNDFL	29954	WDT273	13.6 6	3.17	3	BC/Ventura		Aug NQC	Market
SCE	SUNSHN_2_LNDFL	29954	WDT273	13.6 6	3.17	4	BC/Ventura		Aug NQC	Market
SCE	SUNSHN_2_LNDFL	29954	WDT273	13.6 6	3.17	5	BC/Ventura		Aug NQC	Market

Attachment A - List of physical resources by PTO, local area and market ID

SCE	SYCAMR_2_UNIT 1	24143	SYCCYN1G	13.8	77.41	1	BC/Ventura		Aug NQC	Net Seller
SCE	SYCAMR_2_UNIT 2	24144	SYCCYN2G	13.8	80.00	2	BC/Ventura		Aug NQC	Net Seller
SCE	SYCAMR_2_UNIT 3	24145	SYCCYN3G	13.8	80.00	3	BC/Ventura		Aug NQC	Net Seller
SCE	SYCAMR_2_UNIT 4	24146	SYCCYN4G	13.8	80.00	4	BC/Ventura		Aug NQC	Net Seller
SCE	TENGEN_2_PL1X2	24148	TENNGEN1	13.8	18.80	D1	BC/Ventura		Aug NQC	Net Seller
SCE	TENGEN_2_PL1X2	24149	TENNGEN2	13.8	18.80	D2	BC/Ventura		Aug NQC	Net Seller
SCE	VESTAL_2_KERN	24372	KR 3-1	11	6.50	1	BC/Ventura	Vestal	Aug NQC	QF/Selfgen
SCE	VESTAL_2_KERN	24373	KR 3-2	11	6.13	2	BC/Ventura	Vestal	Aug NQC	QF/Selfgen
SCE	VESTAL_2_RTS042				0.00		BC/Ventura	Vestal	Not modeled Energy Only	Market
SCE	VESTAL_2_SOLAR1	25064	TULRESLR_1	0.39	5.40	1	BC/Ventura	Vestal	Aug NQC	Solar
SCE	VESTAL_2_SOLAR2	25065	TULRESLR_2	0.39	3.78	1	BC/Ventura	Vestal	Aug NQC	Solar
SCE	VESTAL_2_UNIT1				4.03		BC/Ventura	Vestal	Not modeled Aug NQC	Market
SCE	VESTAL_2_WELLHD	24116	WELLGEN	13.8	49.00	1	BC/Ventura	Vestal		Market
SCE	VESTAL_6_QF	29008	LAKEGEN	13.8	5.49	1	BC/Ventura	Vestal	Aug NQC	QF/Selfgen
SCE	WARNE_2_UNIT	25651	WARNE1	13.8	20.79	1	BC/Ventura		Aug NQC	MUNI
SCE	WARNE_2_UNIT	25652	WARNE2	13.8	20.79	2	BC/Ventura		Aug NQC	MUNI
SCE	ZZ_NA	24340	CHARMIN	13.8	2.80	1	BC/Ventura	S.Clara, Moorpark	No NQC - hist. data	QF/Selfgen
SCE	ZZZ_New Unit	29792	ANTLP2_BE_ B1	0.48	208.8 0	EQ	BC/Ventura		No NQC - Pmax	Battery
SCE	ZZZ_New Unit	29528	TOT827_ES	0.48	120.0 0	1	BC/Ventura		No NQC - Pmax	Battery
SCE	ZZZ_New Unit	29824	WDT1519_G	0.48	100.0 0	1	BC/Ventura	S.Clara, Moorpark	No NQC - Pmax	Battery
SCE	ZZZ_New Unit	99739	GOLETA-DIST	66	30.00	S2	BC/Ventura	S.Clara, Moorpark, Goleta	No NQC - Pmax	Battery
SCE	ZZZ_New Unit	29830	WDT1454_G2	0.48	20.00	1	BC/Ventura	S.Clara, Moorpark	No NQC - Pmax	Battery
SCE	ZZZ_New Unit	29826	WDT1454_G1	0.38	20.00	1	BC/Ventura	S.Clara, Moorpark	No NQC - Pmax	Battery
SCE	ZZZ_New Unit	29347	WDT1517_G1	0.36	20.00	1	BC/Ventura		No NQC - Pmax	Battery
SCE	ZZZ_New Unit	99740	S.CLARA- DIST	66	11.00	S2	BC/Ventura	S.Clara, Moorpark	No NQC - Pmax	Battery
SCE	ZZZZZ_APPGEN_6_UNIT 1	24009	APPGEN1G	13.8	0.00	1	BC/Ventura		Retired	Market

Attachment A - List of physical resources by PTO, local area and market ID

SCE	ZZZZ_APPGEN_6_UNIT 1	24010	APPGEN2G	13.8	0.00	2	BC/Ventura		Retired	Market
SCE	ZZZZ_APPGEN_6_UNIT 1	24361	APPGEN3G	13.8	0.00	3	BC/Ventura		Retired	Market
SCE	ZZZZ_MNDALY_7_UNIT 1	24089	MANDLY1G	13.8	0.00	1	BC/Ventura	S.Clara, Moorpark	Retired	Market
SCE	ZZZZ_MNDALY_7_UNIT 2	24090	MANDLY2G	13.8	0.00	2	BC/Ventura	S.Clara, Moorpark	Retired	Market
SCE	ZZZZ_MNDALY_7_UNIT 3	24222	MANDLY3G	16	0.00	3	BC/Ventura	S.Clara, Moorpark	Retired	Market
SCE	ZZZZ_MOORPK_7_UNIT A1	24098	MOORPARK	66	0.00		BC/Ventura	Moorpark	Retired	Market
SCE	ZZZZ_PANDOL_6_UNIT	24113	PANDOL	13.8	0.00	1	BC/Ventura	Vestal	Retired	Market
SCE	ZZZZ_PANDOL_6_UNIT	24113	PANDOL	13.8	0.00	2	BC/Ventura	Vestal	Retired	Market
SCE	ZZZZ_SAUGUS_2_TOLA ND	24135	SAUGUS	66	0.00		BC/Ventura		Retired	Market
SCE	ZZZZ_SAUGUS_6_PTCH GN	24118	PITCHGEN	13.8	0.00	D1	BC/Ventura		Retired	MUNI
SCE	ZZZZ_VESTAL_6_ULTR GN	24150	ULTRAGEN	13.8	0.00	1	BC/Ventura	Vestal	Retired	QF/Selfgen
SCE	ALAMIT_2_PL1X3	24577	ALMT STG	18	251.6 6	S1	LA Basin	Western		Market
SCE	ALAMIT_2_PL1X3	24575	ALMT CTG1	18	211.5 2	G1	LA Basin	Western		Market
SCE	ALAMIT_2_PL1X3	24576	ALMT CTG2	18	211.5 2	G2	LA Basin	Western		Market
SCE	ALAMIT_7_UNIT 3	24003	ALAMT3 G	18	0.00	3	LA Basin	Western	Retired by 2025	Market
SCE	ALAMIT_7_UNIT 4	24004	ALAMT4 G	18	0.00	4	LA Basin	Western	Retired by 2025	Market
SCE	ALAMIT_7_UNIT 5	24005	ALAMT5 G	20	0.00	5	LA Basin	Western	Retired by 2025	Market
SCE	ALTWD_1_QF	25635	ALTWIND	115	3.82	Q1	LA Basin	Eastern, Valley- Devers	Aug NQC	QF/Selfgen
SCE	ALTWD_1_QF	25635	ALTWIND	115	3.82	Q2	LA Basin	Eastern, Valley- Devers	Aug NQC	QF/Selfgen
SCE	ANAHM_2_CANYN1	25211	CanyonGT 1	13.8	49.40	1	LA Basin	Western		MUNI
SCE	ANAHM_2_CANYN2	25212	CanyonGT 2	13.8	48.00	2	LA Basin	Western		MUNI

Attachment A - List of physical resources by PTO, local area and market ID

SCE	ANAHM_2_CANYN3	25213	CanyonGT 3	13.8	48.00	3	LA Basin	Western		MUNI
SCE	ANAHM_2_CANYN4	25214	CanyonGT 4	13.8	49.40	4	LA Basin	Western		MUNI
SCE	ANAHM_7_CT	25208	DowlingCTG	13.8	40.64	1	LA Basin	Western	Aug NQC	MUNI
SCE	ARCOGN_2_UNITS	24011	ARCO 1G	13.8	51.98	1	LA Basin	Western	Aug NQC	Net Seller
SCE	ARCOGN_2_UNITS	24012	ARCO 2G	13.8	51.98	2	LA Basin	Western	Aug NQC	Net Seller
SCE	ARCOGN_2_UNITS	24013	ARCO 3G	13.8	51.98	3	LA Basin	Western	Aug NQC	Net Seller
SCE	ARCOGN_2_UNITS	24014	ARCO 4G	13.8	51.98	4	LA Basin	Western	Aug NQC	Net Seller
SCE	ARCOGN_2_UNITS	24163	ARCO 5G	13.8	25.99	5	LA Basin	Western	Aug NQC	Net Seller
SCE	ARCOGN_2_UNITS	24164	ARCO 6G	13.8	25.99	6	LA Basin	Western	Aug NQC	Net Seller
SCE	BARRE_2_QF	24016	BARRE	230	0.00		LA Basin	Western	Not modeled	QF/Selfgen
SCE	BARRE_6_PEAKEK	29309	BARPKGEN	13.8	47.00	1	LA Basin	Western		Market
SCE	BLAST_1_WIND	24839	BLAST	115	10.29	1	LA Basin	Eastern, Valley-Devers	Aug NQC	Wind
SCE	BUCKWD_1_NPALM1	25634	BUCKWIND	115	0.65		LA Basin	Eastern, Valley-Devers	Not modeled Aug NQC	Wind
SCE	BUCKWD_1_QF	25634	BUCKWIND	115	3.47	QF	LA Basin	Eastern, Valley-Devers	Aug NQC	QF/Selfgen
SCE	BUCKWD_7_WINTCV	25634	BUCKWIND	115	0.28	W5	LA Basin	Eastern, Valley-Devers	Aug NQC	Wind
SCE	CABZON_1_WINDA1	29290	CABAZON	33	8.61	1	LA Basin	Eastern, Valley-Devers	Aug NQC	Wind
SCE	CAPWD_1_QF	25633	CAPWIND	115	4.11	QF	LA Basin	Eastern, Valley-Devers	Aug NQC	QF/Selfgen
SCE	CENTER_2_RHONDO	24203	CENTER S	66	1.91		LA Basin	Western	Not modeled	QF/Selfgen
SCE	CENTER_2_SOLAR1				0.00		LA Basin	Western	Not modeled Energy Only	Solar
SCE	CENTER_2_TECNG1				0.00		LA Basin	Western	Not modeled Energy Only	Market
SCE	CENTER_6_PEAKEK	29308	CTRPKGEN	13.8	47.11	1	LA Basin	Western		Market
SCE	CENTRY_6_PL1X4	25302	CLTNCTRY	13.8	36.00	1	LA Basin	Eastern	Aug NQC	MUNI
SCE	CHEVMN_2_UNITS	24022	CHEVGEN1	13.8	3.77	1	LA Basin	Western, El Nido	Aug NQC	Net Seller
SCE	CHEVMN_2_UNITS	24023	CHEVGEN2	13.8	3.77	2	LA Basin	Western, El Nido	Aug NQC	Net Seller
SCE	CHINO_2_APEBT1	25180	WDT1250BES S_	0.48	20.00	1	LA Basin	Eastern	Aug NQC	Battery
SCE	CHINO_2_JURUPA				0.00		LA Basin	Eastern	Not modeled Energy Only	Market
SCE	CHINO_2_QF				0.00		LA Basin	Eastern	Not modeled Aug NQC	QF/Selfgen

Attachment A - List of physical resources by PTO, local area and market ID

SCE	CHINO_2_SASOLR				0.00		LA Basin	Eastern	Not modeled Energy Only	Solar
SCE	CHINO_2_SOLAR				0.27		LA Basin	Eastern	Not modeled	Solar
SCE	CHINO_2_SOLAR2				0.00		LA Basin	Eastern	Not modeled Energy Only	Solar
SCE	CHINO_6_CIMGEN	24026	CIMGEN	13.8	26.00	D1	LA Basin	Eastern	Aug NQC	QF/Selfgen
SCE	CHINO_7_MILIKN	24024	CHINO	66	1.19		LA Basin	Eastern	Not modeled Aug NQC	Market
SCE	COLTON_6_AGUAM1	25303	CLTNAGUA	13.8	43.00	1	LA Basin	Eastern	Aug NQC	MUNI
SCE	CORONS_2_SOLAR				0.00		LA Basin	Eastern	Not modeled Energy Only	Solar
SCE	CORONS_6_CLRWTR	29338	CLRWTRCT	13.8	20.72	G1	LA Basin	Eastern		MUNI
SCE	CORONS_6_CLRWTR	29340	CLRWTRST	13.8	7.28	S1	LA Basin	Eastern		MUNI
SCE	DELAMO_2_SOLAR1				0.41		LA Basin	Western	Not modeled Aug NQC	Solar
SCE	DELAMO_2_SOLAR2				0.47		LA Basin	Western	Not modeled Aug NQC	Solar
SCE	DELAMO_2_SOLAR3				0.34		LA Basin	Western	Not modeled Aug NQC	Solar
SCE	DELAMO_2_SOLAR4				0.35		LA Basin	Western	Not modeled Aug NQC	Solar
SCE	DELAMO_2_SOLAR5				0.27		LA Basin	Western	Not modeled Aug NQC	Solar
SCE	DELAMO_2_SOLAR6				0.54		LA Basin	Western	Not modeled Aug NQC	Solar
SCE	DELAMO_2_SOLRC1				0.00		LA Basin	Western	Not modeled Energy Only	Solar
SCE	DELAMO_2_SOLRD				0.00		LA Basin	Western	Not modeled Energy Only	Solar
SCE	DEVERS_1_QF	25639	SEAWIND	115	0.92	QF	LA Basin	Eastern, Valley- Devers	Aug NQC	QF/Selfgen
SCE	DEVERS_1_QF	25632	TERAWND	115	0.76	QF	LA Basin	Eastern, Valley- Devers	Aug NQC	QF/Selfgen
SCE	DEVERS_1_SEPV05				0.00		LA Basin	Eastern, Valley- Devers	Not modeled Energy Only	Market
SCE	DEVERS_1_SOLAR				0.00		LA Basin	Eastern, Valley- Devers	Not modeled Energy Only	Solar
SCE	DEVERS_1_SOLAR1				0.00		LA Basin	Eastern, Valley- Devers	Not modeled Energy Only	Solar

Attachment A - List of physical resources by PTO, local area and market ID

SCE	DEVERS_1_SOLAR2				0.00		LA Basin	Eastern, Valley-Devers	Not modeled Energy Only	Solar
SCE	DEVERS_2_CS2SR4				0.00		LA Basin	Eastern, Valley-Devers	Not modeled Energy Only	Solar
SCE	DEVERS_2_DHSPG2				0.00		LA Basin	Eastern, Valley-Devers	Not modeled Energy Only	Market
SCE	DMDVLY_1_UNITS	25425	ESRP P2	6.9	3.00	8	LA Basin	Eastern	Aug NQC	QF/Selfgen
SCE	DREWS_6_PL1X4	25301	CLTNDREW	13.8	36.00	1	LA Basin	Eastern	Aug NQC	MUNI
SCE	DVLCYN_1_UNITS	25603	DVLCYN3G	13.8	36.95	3	LA Basin	Eastern	Aug NQC	MUNI
SCE	DVLCYN_1_UNITS	25604	DVLCYN4G	13.8	36.95	4	LA Basin	Eastern	Aug NQC	MUNI
SCE	DVLCYN_1_UNITS	25648	DVLCYN1G	13.8	27.72	1	LA Basin	Eastern	Aug NQC	MUNI
SCE	DVLCYN_1_UNITS	25649	DVLCYN2G	13.8	27.72	2	LA Basin	Eastern	Aug NQC	MUNI
SCE	ELLIS_2_QF	24325	ORCOGEN	13.8	0.06	1	LA Basin	Western	Aug NQC	QF/Selfgen
SCE	ELSEGN_2_UN1011	29904	ELSEG5GT	16.5	131.50	5	LA Basin	Western, El Nido	Aug NQC	Market
SCE	ELSEGN_2_UN1011	29903	ELSEG6ST	13.8	131.50	6	LA Basin	Western, El Nido	Aug NQC	Market
SCE	ELSEGN_2_UN2021	29902	ELSEG7GT	16.5	131.84	7	LA Basin	Western, El Nido	Aug NQC	Market
SCE	ELSEGN_2_UN2021	29901	ELSEG8ST	13.8	131.84	8	LA Basin	Western, El Nido	Aug NQC	Market
SCE	ETIWND_2_CHMPNE				0.00		LA Basin	Eastern	Not modeled Energy Only	Market
SCE	ETIWND_2_FONTNA	24055	ETIWANDA	66	0.21		LA Basin	Eastern	Not modeled Aug NQC	QF/Selfgen
SCE	ETIWND_2_RTS010	24055	ETIWANDA	66	0.41		LA Basin	Eastern	Not modeled Aug NQC	Market
SCE	ETIWND_2_RTS015	24055	ETIWANDA	66	0.81		LA Basin	Eastern	Not modeled Aug NQC	Market
SCE	ETIWND_2_RTS017	24055	ETIWANDA	66	0.95		LA Basin	Eastern	Not modeled Aug NQC	Market
SCE	ETIWND_2_RTS018	24055	ETIWANDA	66	0.41		LA Basin	Eastern	Not modeled Aug NQC	Market
SCE	ETIWND_2_RTS023	24055	ETIWANDA	66	0.68		LA Basin	Eastern	Not modeled Aug NQC	Market
SCE	ETIWND_2_RTS026	24055	ETIWANDA	66	1.62		LA Basin	Eastern	Not modeled Aug NQC	Market
SCE	ETIWND_2_RTS027	24055	ETIWANDA	66	0.54		LA Basin	Eastern	Not modeled Aug NQC	Market

Attachment A - List of physical resources by PTO, local area and market ID

SCE	ETIWND_2_SOLAR1				0.00		LA Basin	Eastern	Not modeled Energy Only	Solar
SCE	ETIWND_2_SOLAR2				0.00		LA Basin	Eastern	Not modeled Energy Only	Solar
SCE	ETIWND_2_SOLAR5				0.00		LA Basin	Eastern	Not modeled Energy Only	Solar
SCE	ETIWND_2_UNIT1	24071	INLAND	13.8	10.34	1	LA Basin	Eastern	Aug NQC	QF/Selfgen
SCE	ETIWND_6_GRPLND	29305	ETWPKGEN	13.8	47.39	1	LA Basin	Eastern		Market
SCE	ETIWND_6_MWDETI	25422	ETI MWDG	13.8	16.70	1	LA Basin	Eastern	Aug NQC	Market
SCE	GARNET_1_SOLAR	24815	GARNET	115	0.00		LA Basin	Eastern, Valley- Devers	Not modeled Energy Only	Solar
SCE	GARNET_1_SOLAR2	24815	GARNET	115	1.08		LA Basin	Eastern, Valley- Devers	Not modeled Aug NQC	Solar
SCE	GARNET_1_UNITS	24815	GARNET	115	1.63	G1	LA Basin	Eastern, Valley- Devers	Aug NQC	Market
SCE	GARNET_1_UNITS	24815	GARNET	115	1.28	G3	LA Basin	Eastern, Valley- Devers	Aug NQC	Market
SCE	GARNET_1_UNITS	24815	GARNET	115	0.56	G2	LA Basin	Eastern, Valley- Devers	Aug NQC	Market
SCE	GARNET_1_WIND	24815	GARNET	115	1.37		LA Basin	Eastern, Valley- Devers	Not modeled Aug NQC	Wind
SCE	GARNET_1_WINDS	24815	GARNET	115	4.73	W2	LA Basin	Eastern, Valley- Devers	Aug NQC	Wind
SCE	GARNET_1_WT3WIND	24815	GARNET	115	0.00	W3	LA Basin	Eastern, Valley- Devers	Aug NQC	Market
SCE	GARNET_2_DIFWD1	24815	GARNET	115	1.65		LA Basin	Eastern, Valley- Devers	Aug NQC	Market
SCE	GARNET_2_HYDRO	24815	GARNET	115	0.76	QF	LA Basin	Eastern, Valley- Devers	Aug NQC	Market
SCE	GARNET_2_WIND1	24815	GARNET	115	2.35		LA Basin	Eastern, Valley- Devers	Not modeled Aug NQC	Wind
SCE	GARNET_2_WIND2	24815	GARNET	115	2.46		LA Basin	Eastern, Valley- Devers	Not modeled Aug NQC	Wind
SCE	GARNET_2_WIND3	24815	GARNET	115	2.65		LA Basin	Eastern, Valley- Devers	Not modeled Aug NQC	Wind
SCE	GARNET_2_WIND4	24815	GARNET	115	2.06		LA Basin	Eastern, Valley- Devers	Not modeled Aug NQC	Wind
SCE	GARNET_2_WIND5	24815	GARNET	115	0.63		LA Basin	Eastern, Valley- Devers	Not modeled Aug NQC	Wind

Attachment A - List of physical resources by PTO, local area and market ID

SCE	GARNET_2_WPMWD6	24815	GARNET	115	1.25		LA Basin	Eastern, Valley-Devers	Not modeled Aug NQC	Wind
SCE	GLNARM_2_UNIT 5	29013	GLENARM5_CT	13.8	50.00	CT	LA Basin	Western		MUNI
SCE	GLNARM_2_UNIT 5	29014	GLENARM5_ST	13.8	15.00	ST	LA Basin	Western		MUNI
SCE	GLNARM_7_UNIT 1	29005	PASADNA1	13.8	22.07	1	LA Basin	Western		MUNI
SCE	GLNARM_7_UNIT 2	29006	PASADNA2	13.8	22.30	1	LA Basin	Western		MUNI
SCE	GLNARM_7_UNIT 3	25042	PASADNA3	13.8	44.83	1	LA Basin	Western		MUNI
SCE	GLNARM_7_UNIT 4	25043	PASADNA4	13.8	42.42	1	LA Basin	Western		MUNI
SCE	HARBGN_7_UNITS	24062	HARBOR G	13.8	76.27	1	LA Basin	Western		Market
SCE	HARBGN_7_UNITS	24062	HARBOR G	13.8	11.86	HP	LA Basin	Western		Market
SCE	HARBGN_7_UNITS	25510	HARBORG4	4.16	11.86	LP	LA Basin	Western		Market
SCE	HINSON_6_CARBG	24020	CARBGEN1	13.8	14.43	1	LA Basin	Western	Aug NQC	Market
SCE	HINSON_6_CARBG	24328	CARBGEN2	13.8	14.43	1	LA Basin	Western	Aug NQC	Market
SCE	HINSON_6_LBECH1	24170	LBEACH12	13.8	65.00	1	LA Basin	Western		Market
SCE	HINSON_6_LBECH2	24170	LBEACH12	13.8	65.00	2	LA Basin	Western		Market
SCE	HINSON_6_LBECH3	24171	LBEACH34	13.8	65.00	3	LA Basin	Western		Market
SCE	HINSON_6_LBECH4	24171	LBEACH34	13.8	65.00	4	LA Basin	Western		Market
SCE	HINSON_6_SERRGN	24139	SERRFGEN	13.8	34.00	D1	LA Basin	Western	Aug NQC	Market
SCE	HNTGBH_2_PL1X3	24581	HUNTBCH CTG2	18	211.23	G2	LA Basin	Western		Market
SCE	HNTGBH_2_PL1X3	24582	HUNTBCH STG	18	251.34	S1	LA Basin	Western		Market
SCE	HNTGBH_2_PL1X3	24580	HUNTBCH CTG1	18	211.23	G1	LA Basin	Western		Market
SCE	HNTGBH_7_UNIT 2	24067	HUNT2 G	13.8	0.00	2	LA Basin	Western	Retired by 2025	Market
SCE	INDIGO_1_UNIT 1	29190	WINTECX2	13.8	42.00	1	LA Basin	Eastern, Valley-Devers		Market
SCE	INDIGO_1_UNIT 2	29191	WINTECX1	13.8	42.00	1	LA Basin	Eastern, Valley-Devers		Market
SCE	INDIGO_1_UNIT 3	29180	WINTEC8	13.8	42.00	1	LA Basin	Eastern, Valley-Devers		Market
SCE	LACIEN_2_VENICE	24337	VENICE	13.8	3.00	1	LA Basin	Western, El Nido	Aug NQC	MUNI
SCE	LAGBEL_6_QF	29951	REFUSE	13.8	0.35	D1	LA Basin	Western	Aug NQC	QF/Selfgen
SCE	LGHTHP_6_ICEGEN	24070	ICEGEN	13.8	48.00	1	LA Basin	Western	Aug NQC	QF/Selfgen
SCE	MESAS_2_QF	24209	MESA CAL	66	0.00		LA Basin	Western	Not modeled Aug NQC	QF/Selfgen

Attachment A - List of physical resources by PTO, local area and market ID

SCE	MIRLOM_2_CORONA				0.00		LA Basin	Eastern	Not modeled Aug NQC	QF/Selfgen
SCE	MIRLOM_2_LNDFL				0.81		LA Basin	Eastern	Not modeled Aug NQC	Market
SCE	MIRLOM_2_MLBBTA	25185	WDT1425_G1	0.48	10.00	1	LA Basin	Eastern	Aug NQC	Battery
SCE	MIRLOM_2_MLBBTB	25186	WDT1426_G2	0.48	10.00	1	LA Basin	Eastern	Aug NQC	Battery
SCE	MIRLOM_2_ONTARO				1.49		LA Basin	Eastern	Not modeled Aug NQC	Market
SCE	MIRLOM_2_RTS032				0.41		LA Basin	Eastern	Not modeled Aug NQC	Market
SCE	MIRLOM_2_RTS033				0.27		LA Basin	Eastern	Not modeled Aug NQC	Market
SCE	MIRLOM_2_TEMESC				0.00		LA Basin	Eastern	Not modeled Aug NQC	QF/Selfgen
SCE	MIRLOM_6_PEAKER	29307	MRLPKGEN	13.8	46.00	1	LA Basin	Eastern		Market
SCE	MIRLOM_7_MWDLKM	24210	MIRALOMA	66	1.80		LA Basin	Eastern	Not modeled Aug NQC	MUNI
SCE	MOJAVE_1_SIPHON	25657	MJVSPHN1	13.8	3.20	1	LA Basin	Eastern	Aug NQC	Market
SCE	MOJAVE_1_SIPHON	25658	MJVSPHN1	13.8	3.20	2	LA Basin	Eastern	Aug NQC	Market
SCE	MOJAVE_1_SIPHON	25659	MJVSPHN1	13.8	3.20	3	LA Basin	Eastern	Aug NQC	Market
SCE	MTWIND_1_UNIT 1	29060	MOUNTWND	115	9.32	S1	LA Basin	Eastern, Valley- Devers	Aug NQC	Wind
SCE	MTWIND_1_UNIT 2	29060	MOUNTWND	115	4.66	S2	LA Basin	Eastern, Valley- Devers	Aug NQC	Wind
SCE	MTWIND_1_UNIT 3	29060	MOUNTWND	115	4.71	S3	LA Basin	Eastern, Valley- Devers	Aug NQC	Wind
SCE	OLINDA_2_COYCRK	24211	OLINDA	66	3.13		LA Basin	Western	Not modeled	QF/Selfgen
SCE	OLINDA_2_LNDFL2	29011	BREAPWR2	13.8	7.16	S1	LA Basin	Western	Aug NQC	Market
SCE	OLINDA_2_LNDFL2	29011	BREAPWR2	13.8	4.00	C1	LA Basin	Western	Aug NQC	Market
SCE	OLINDA_2_LNDFL2	29011	BREAPWR2	13.8	4.00	C2	LA Basin	Western	Aug NQC	Market
SCE	OLINDA_2_LNDFL2	29011	BREAPWR2	13.8	4.00	C3	LA Basin	Western	Aug NQC	Market
SCE	OLINDA_2_LNDFL2	29011	BREAPWR2	13.8	4.00	C4	LA Basin	Western	Aug NQC	Market
SCE	OLINDA_2_QF	24211	OLINDA	66	0.00		LA Basin	Western	Not modeled Aug NQC	QF/Selfgen
SCE	OLINDA_7_BLKSNL	24211	OLINDA	66	0.36		LA Basin	Western	Not modeled Aug NQC	Market
SCE	OLINDA_7_LNDFIL	24211	OLINDA	66	0.00		LA Basin	Western	Not modeled Aug NQC	QF/Selfgen

Attachment A - List of physical resources by PTO, local area and market ID

SCE	PADUA_2_ONTARO	24111	PADUA	66	0.35		LA Basin	Eastern	Not modeled Aug NQC	QF/Selfgen
SCE	PADUA_2_SOLAR1	24111	PADUA	66	0.00		LA Basin	Eastern	Not modeled Energy Only	Solar
SCE	PADUA_6_MWSDSM	24111	PADUA	66	2.60		LA Basin	Eastern	Not modeled Aug NQC	MUNI
SCE	PADUA_6_QF	24111	PADUA	66	0.39		LA Basin	Eastern	Not modeled Aug NQC	QF/Selfgen
SCE	PADUA_7_SDIMAS	24111	PADUA	66	1.05		LA Basin	Eastern	Not modeled Aug NQC	Market
SCE	PANSEA_1_PANARO	25640	PANAERO	115	6.30	QF	LA Basin	Eastern, Valley-Devers	Aug NQC	Wind
SCE	PWEST_1_UNIT	24815	GARNET	115	0.44	PC	LA Basin	Western	Aug NQC	Market
SCE	REDOND_7_UNIT 5	24121	REDON5 G	18	0.00	5	LA Basin	Western	Retired by 2025	Market
SCE	REDOND_7_UNIT 6	24122	REDON6 G	18	0.00	6	LA Basin	Western	Retired by 2025	Market
SCE	REDOND_7_UNIT 8	24124	REDON8 G	20	0.00	8	LA Basin	Western	Retired by 2025	Market
SCE	RENWD_1_QF	25636	RENWIND	115	1.33	Q1	LA Basin	Eastern, Valley-Devers	Aug NQC	QF/Selfgen
SCE	RENWD_1_QF	25636	RENWIND	115	1.32	Q2	LA Basin	Eastern, Valley-Devers	Aug NQC	QF/Selfgen
SCE	RVSIDE_2_RERCU3	24299	RERC2G3	13.8	49.00	1	LA Basin	Eastern		MUNI
SCE	RVSIDE_2_RERCU4	24300	RERC2G4	13.8	49.00	1	LA Basin	Eastern		MUNI
SCE	RVSIDE_6_RERCU1	24242	RERC1G	13.8	48.35	1	LA Basin	Eastern		MUNI
SCE	RVSIDE_6_RERCU2	24243	RERC2G	13.8	48.50	1	LA Basin	Eastern		MUNI
SCE	RVSIDE_6_SOLAR1	24244	SPRINGEN	13.8	2.03		LA Basin	Eastern	Not modeled Aug NQC	Solar
SCE	RVSIDE_6_SPRING	24244	SPRINGEN	13.8	36.00	1	LA Basin	Eastern		Market
SCE	SANITR_6_UNITS	24324	SANIGEN	13.8	0.84	D1	LA Basin	Eastern	Aug NQC	QF/Selfgen
SCE	SANTGO_2_LNDFL1	24341	COYGEN	13.8	18.65	1	LA Basin	Western	Aug NQC	Market
SCE	SANTGO_2_MABBT1	25192	WDT1406_G	0.48	2.00	1	LA Basin	Western	Aug NQC	Battery
SCE	SANWD_1_QF	25646	SANWIND	115	3.26	Q1	LA Basin	Eastern, Valley-Devers	Aug NQC	Wind
SCE	SANWD_1_QF	25646	SANWIND	115	3.26	Q2	LA Basin	Eastern, Valley-Devers	Aug NQC	Wind
SCE	SBERDO_2_PSP3	24923	MNTV-ST1	18	257.8 2	1	LA Basin	Eastern, West of Devers		Market

Attachment A - List of physical resources by PTO, local area and market ID

SCE	SBERDO_2_PSP3	24921	MNTV-CT1	18	148.59	1	LA Basin	Eastern, West of Devers		Market
SCE	SBERDO_2_PSP3	24922	MNTV-CT2	18	148.59	1	LA Basin	Eastern, West of Devers		Market
SCE	SBERDO_2_PSP4	24926	MNTV-ST2	18	257.82	1	LA Basin	Eastern, West of Devers		Market
SCE	SBERDO_2_PSP4	24924	MNTV-CT3	18	148.59	1	LA Basin	Eastern, West of Devers		Market
SCE	SBERDO_2_PSP4	24925	MNTV-CT4	18	148.59	1	LA Basin	Eastern, West of Devers		Market
SCE	SBERDO_2_QF	24214	SANBRDNO	66	0.14		LA Basin	Eastern, West of Devers	Not modeled Aug NQC	QF/Selfgen
SCE	SBERDO_2_REDLND	24214	SANBRDNO	66	0.54		LA Basin	Eastern, West of Devers	Not modeled Aug NQC	Market
SCE	SBERDO_2_RTS005	24214	SANBRDNO	66	0.68		LA Basin	Eastern, West of Devers	Not modeled Aug NQC	Market
SCE	SBERDO_2_RTS007	24214	SANBRDNO	66	0.68		LA Basin	Eastern, West of Devers	Not modeled Aug NQC	Market
SCE	SBERDO_2_RTS011	24214	SANBRDNO	66	0.95		LA Basin	Eastern, West of Devers	Not modeled Aug NQC	Market
SCE	SBERDO_2_RTS013	24214	SANBRDNO	66	0.95		LA Basin	Eastern, West of Devers	Not modeled Aug NQC	Market
SCE	SBERDO_2_RTS016	24214	SANBRDNO	66	0.41		LA Basin	Eastern, West of Devers	Not modeled Aug NQC	Market
SCE	SBERDO_2_RTS048	24214	SANBRDNO	66	0.00		LA Basin	Eastern, West of Devers	Not modeled Energy Only	Market
SCE	SBERDO_2_SNTANA	24214	SANBRDNO	66	0.30		LA Basin	Eastern, West of Devers	Not modeled Aug NQC	QF/Selfgen
SCE	SBERDO_6_MILLCK	24214	SANBRDNO	66	1.09		LA Basin	Eastern, West of Devers	Not modeled Aug NQC	QF/Selfgen
SCE	SENTNL_2_CTG1	29101	SENTINEL_G1	13.8	103.76	1	LA Basin	Eastern, Valley-Devers		Market
SCE	SENTNL_2_CTG2	29102	SENTINEL_G2	13.8	95.34	1	LA Basin	Eastern, Valley-Devers		Market
SCE	SENTNL_2_CTG3	29103	SENTINEL_G3	13.8	96.85	1	LA Basin	Eastern, Valley-Devers		Market
SCE	SENTNL_2_CTG4	29104	SENTINEL_G4	13.8	102.47	1	LA Basin	Eastern, Valley-Devers		Market
SCE	SENTNL_2_CTG5	29105	SENTINEL_G5	13.8	103.81	1	LA Basin	Eastern, Valley-Devers		Market

Attachment A - List of physical resources by PTO, local area and market ID

SCE	SENTNL_2_C TG6	29106	SENTINEL_G6	13.8	100.9 9	1	LA Basin	Eastern, Valley-Devers		Market
SCE	SENTNL_2_C TG7	29107	SENTINEL_G7	13.8	97.06	1	LA Basin	Eastern, Valley-Devers		Market
SCE	SENTNL_2_C TG8	29108	SENTINEL_G8	13.8	101.8 0	1	LA Basin	Eastern, Valley-Devers		Market
SCE	TIFFNY_1_DILLON	29021	WINTEC6	115	9.45	1	LA Basin	Eastern, Valley-Devers	Aug NQC	Wind
SCE	TRNSWD_1_QF	25637	TRANWIND	115	8.18	QF	LA Basin	Eastern, Valley-Devers	Aug NQC	Wind
SCE	TULEWD_1_TULWD1				26.80		LA Basin	Eastern, Valley-Devers	Not modeled Aug NQC	Wind
SCE	VALLEY_5_PERRIS	24160	VALLEYSC	115	7.94		LA Basin	Eastern, Valley, Valley-Devers	Not modeled Aug NQC	QF/Selfgen
SCE	VALLEY_5_REDMTN	24160	VALLEYSC	115	3.80		LA Basin	Eastern, Valley, Valley-Devers	Not modeled Aug NQC	QF/Selfgen
SCE	VALLEY_5_RTS044	24160	VALLEYSC	115	2.16		LA Basin	Eastern, Valley, Valley-Devers	Not modeled Aug NQC	Market
SCE	VALLEY_5_SOLAR1	24160	VALLEYSC	115	0.00		LA Basin	Eastern, Valley, Valley-Devers	Not modeled Energy Only	Solar
SCE	VALLEY_5_SOLAR2	25082	WDT786	34.5	5.40	EQ	LA Basin	Eastern, Valley, Valley-Devers	Aug NQC	Solar
SCE	VENWD_1_WIND1	25645	VENWIND	115	1.98	Q1	LA Basin	Eastern, Valley-Devers	Aug NQC	QF/Selfgen
SCE	VENWD_1_WIND2	25645	VENWIND	115	3.37	Q2	LA Basin	Eastern, Valley-Devers	Aug NQC	QF/Selfgen
SCE	VENWD_1_WIND3	25645	VENWIND	115	4.00	EU	LA Basin	Eastern, Valley-Devers	Aug NQC	QF/Selfgen
SCE	VERNON_6_GONZL1	24342	FEDGEN	13.8	5.75	1	LA Basin	Western		MUNI
SCE	VERNON_6_GONZL2	24342	FEDGEN	13.8	5.75	1	LA Basin	Western		MUNI
SCE	VERNON_6_MALBRG	24241	MALBRG3G	13.8	49.26	S3	LA Basin	Western		MUNI
SCE	VERNON_6_MALBRG	24239	MALBRG1G	13.8	42.37	C1	LA Basin	Western		MUNI
SCE	VERNON_6_MALBRG	24240	MALBRG2G	13.8	42.37	C2	LA Basin	Western		MUNI
SCE	VILLPK_2_VALLYV	24216	VILLA PK	66	4.10	DG	LA Basin	Western	Aug NQC	QF/Selfgen
SCE	VILLPK_6_MWDYOR	24216	VILLA PK	66	3.60		LA Basin	Western	Not modeled Aug NQC	MUNI
SCE	VISTA_2_RIALTO	24901	VSTA	230	0.27		LA Basin	Eastern	Not modeled	Market
SCE	VISTA_2_RTS028	24901	VSTA	230	0.95		LA Basin	Eastern	Not modeled Aug NQC	Market

Attachment A - List of physical resources by PTO, local area and market ID

SCE	VISTA_6_QF	24902	VSTA	66	0.10		LA Basin	Eastern	Not modeled Aug NQC	QF/Selfgen
SCE	WALCRK_2_CTG1	29201	WALCRKG1	13.8	96.43	1	LA Basin	Western		Market
SCE	WALCRK_2_CTG2	29202	WALCRKG2	13.8	96.91	1	LA Basin	Western		Market
SCE	WALCRK_2_CTG3	29203	WALCRKG3	13.8	96.65	1	LA Basin	Western		Market
SCE	WALCRK_2_CTG4	29204	WALCRKG4	13.8	96.49	1	LA Basin	Western		Market
SCE	WALCRK_2_CTG5	29205	WALCRKG5	13.8	96.65	1	LA Basin	Western		Market
SCE	WALNUT_2_SOLAR				0.00		LA Basin	Western	Not modeled Energy Only	Solar
SCE	WALNUT_6_HILLGEN	24063	HILLGEN	13.8	32.97	D1	LA Basin	Western	Aug NQC	Net Seller
SCE	WALNUT_7_WCOVST	24157	WALNUT	66	5.37		LA Basin	Western	Not modeled Aug NQC	Market
SCE	WHTWTR_1_WINDA1	29061	WHITEWTR	33	12.92	1	LA Basin	Eastern, Valley- Devers	Aug NQC	Wind
SCE	ZZ_ARCOGN_2_UNITS	24018	BRIGEN	13.8	0.00	1	LA Basin	Western	No NQC - hist. data	Net Seller
SCE	ZZ_HINSON_6_QF	24064	HINSON	66	0.00	1	LA Basin	Western	No NQC - hist. data	QF/Selfgen
SCE	ZZ_LAFRES_6_QF	24332	PALOGEN	13.8	0.00	D1	LA Basin	Western, El Nido	No NQC - hist. data	QF/Selfgen
SCE	ZZ_MOBGEN_6_UNIT 1	24094	MOBGEN	13.8	0.00	1	LA Basin	Western, El Nido	No NQC - hist. data	QF/Selfgen
SCE	ZZ_NA	24327	THUMSGEN	13.8	0.00	1	LA Basin	Western	No NQC - hist. data	QF/Selfgen
SCE	ZZ_NA	24329	MOBGEN2	13.8	0.00	1	LA Basin	Western, El Nido	No NQC - hist. data	QF/Selfgen
SCE	ZZ_NA	24330	OUTFALL1	13.8	0.00	1	LA Basin	Western, El Nido	No NQC - hist. data	QF/Selfgen
SCE	ZZ_NA	24331	OUTFALL2	13.8	0.00	1	LA Basin	Western, El Nido	No NQC - hist. data	QF/Selfgen
SCE	ZZ_NA	29260	ALTAMSA4	115	0.00	1	LA Basin	Eastern, Valley- Devers	No NQC - hist. data	Wind
SCE	ZZZ_New	69808 2	ALMITOS B1A	0.42	50.00	1	LA Basin	Western	No NQC - Pmax	Market
SCE	ZZZ_New	69808 3	ALMITOS B12	0.42	50.00	1	LA Basin	Western	No NQC - Pmax	Market
SCE	ZZZ_New	97624	WH_STN_1	13.8	49.00	1	LA Basin	Western	No NQC - Pmax	Market
SCE	ZZZ_New	97625	WH_STN_2	13.8	49.00	1	LA Basin	Western	No NQC - Pmax	Market

Attachment A - List of physical resources by PTO, local area and market ID

SCE	ZZZZ_ALAMIT_7_UNIT 1	24001	ALAMT1 G	18	0.00	1	LA Basin	Western	Retired	Market
SCE	ZZZZ_ALAMIT_7_UNIT 2	24002	ALAMT2 G	18	0.00	2	LA Basin	Western	Retired	Market
SCE	ZZZZ_ALAMIT_7_UNIT 6	24161	ALAMT6 G	20	0.00	6	LA Basin	Western	Retired	Market
SCE	ZZZZ_BRDWAY_7_UNIT 3	29007	BRODWYSC	13.8	0.00		LA Basin	Western	Retired	MUNI
SCE	ZZZZ_CENTER_2_QF	29953	SIGGEN	13.8	0.00	D1	LA Basin	Western	Retired	QF/Selfgen
SCE	ZZZZ_CHINO_6_SMPPA P	24140	SIMPSON	13.8	0.00	D1	LA Basin	Eastern	Retired	QF/Selfgen
SCE	ZZZZ_ETIWND_7_MIDVLY	24055	ETIWANDA	66	0.00		LA Basin	Eastern	Retired	QF/Selfgen
SCE	ZZZZ_ETIWND_7_UNIT 3	24052	MTNVIST3	18	0.00	3	LA Basin	Eastern	Retired	Market
SCE	ZZZZ_ETIWND_7_UNIT 4	24053	MTNVIST4	18	0.00	4	LA Basin	Eastern	Retired	Market
SCE	ZZZZ_HNTGBH_7_UNIT 1	24066	HUNT1 G	13.8	0.00	1	LA Basin	Western	Retired	Market
SCE	ZZZZ_INLDEM_5_UNIT 1	29041	IIEC-G1	19.5	0.00	1	LA Basin	Eastern, Valley, Valley-Devers	Retired	Market
SCE	ZZZZ_INLDEM_5_UNIT 2	29042	IIEC-G2	19.5	0.00	1	LA Basin	Eastern, Valley, Valley-Devers	Retired	Market
SCE	ZZZZ_LAGBEL_2_STG1				0.00		LA Basin	Western	Retired	Market
SCE	ZZZZ_MIRLOM_6_DELGEN	29339	DELGEN	13.8	0.00	1	LA Basin	Eastern	Retired	QF/Selfgen
SCE	ZZZZ_REDOND_7_UNIT 7	24123	REDON7 G	20	0.00	7	LA Basin	Western	Retired	Market
SCE	ZZZZ_RHONDO_2_QF	24213	RIOHONDO	66	0.00	DG	LA Basin	Western	Retired	QF/Selfgen
SCE	ZZZZ_RHONDO_6_PUENTE	24213	RIOHONDO	66	0.00		LA Basin	Western	Retired	Net Seller
SCE	ZZZZ_VALLEY_7_BADLAND	24160	VALLEYSC	115	0.00		LA Basin	Eastern, Valley, Valley-Devers	Retired	Market
SCE	ZZZZ_VALLEY_7_UNITA 1	24160	VALLEYSC	115	0.00		LA Basin	Eastern, Valley, Valley-Devers	Retired	Market
SCE	ZZZZ_WALNUT_7_WCOVCT	24157	WALNUT	66	0.00		LA Basin	Western	Retired	Market
SCE	ZZZZ_ELSEGN_7_UNIT 4	24048	ELSEG4 G	18	0.00	4	LA Basin	Western, El Nido	Retired	Market

Attachment A - List of physical resources by PTO, local area and market ID

SDG&E	BORDER_6_UNITA1	22149	CALPK_BD	13.8	51.25	1	SD-IV	San Diego, Border		Market
SDG&E	BREGGO_6_DEGRSL	22085	BORREGO	12.5	1.70	DG	SD-IV	San Diego	Aug NQC	Solar
SDG&E	BREGGO_6_SOLAR	22082	BR GEN1	0.21	7.02	1	SD-IV	San Diego	Aug NQC	Solar
SDG&E	CARLS1_2_CARCT1	22783	EA5 REPOWER1	13.8	105.50	1	SD-IV	San Diego	Aug NQC	Market
SDG&E	CARLS1_2_CARCT1	22784	EA5 REPOWER2	13.8	105.50	1	SD-IV	San Diego	Aug NQC	Market
SDG&E	CARLS1_2_CARCT1	22786	EA5 REPOWER4	13.8	105.50	1	SD-IV	San Diego	Aug NQC	Market
SDG&E	CARLS1_2_CARCT1	22788	EA5 REPOWER3	13.8	105.50	1	SD-IV	San Diego	Aug NQC	Market
SDG&E	CARLS2_1_CARCT1	22787	EA5 REPOWER5	13.8	105.50	1	SD-IV	San Diego	Aug NQC	Market
SDG&E	CCRITA_7_RPPCHF	22124	CHCARITA	138	3.60	1	SD-IV	San Diego	Aug NQC	Market
SDG&E	CHILLS_1_SYCENG	22120	CARLTNHS	138	0.62	1	SD-IV	San Diego	Aug NQC	QF/Selfgen
SDG&E	CHILLS_7_UNITA1	22120	CARLTNHS	138	1.52	2	SD-IV	San Diego	Aug NQC	QF/Selfgen
SDG&E	CNTNLA_2_SOLAR1	23463	DW GEN3&4	0.33	33.75	1	SD-IV		Aug NQC	Solar
SDG&E	CNTNLA_2_SOLAR2	23463	DW GEN3&4	0.33	0.00	2	SD-IV		Energy Only	Solar
SDG&E	CPSTNO_7_PRMADS	22112	CAPSTRNO	138	5.71	1	SD-IV	San Diego	Aug NQC	Market
SDG&E	CPVERD_2_SOLAR	23309	IV GEN3 G1	0.31	20.85	G1	SD-IV		Aug NQC	Solar
SDG&E	CPVERD_2_SOLAR	23301	IV GEN3 G2	0.31	16.68	G2	SD-IV		Aug NQC	Solar
SDG&E	CRELMN_6_RAMON1	22152	CREELMAN	69	0.54	DG	SD-IV	San Diego	Aug NQC	Solar
SDG&E	CRELMN_6_RAMON2	22152	CREELMAN	69	1.35	DG	SD-IV	San Diego	Aug NQC	Solar
SDG&E	CRELMN_6_RAMSR3				0.93		SD-IV	San Diego	Not modeled Aug NQC	Solar
SDG&E	CRSTWD_6_KUMYAY	22915	KUMEYAAY	0.69	10.50	1	SD-IV	San Diego	Aug NQC	Wind
SDG&E	CSLR4S_2_SOLAR	23298	DW GEN1 G1	0.315	17.55	G1	SD-IV		Aug NQC	Solar
SDG&E	CSLR4S_2_SOLAR	23299	DW GEN1 G2	0.315	17.55	G2	SD-IV		Aug NQC	Solar
SDG&E	ELCAJN_6_EB1BT1	22208	EL CAJON	69	7.50	1	SD-IV	San Diego, El Cajon		Battery
SDG&E	ELCAJN_6_LM6K	23320	EC GEN2	13.8	48.10	1	SD-IV	San Diego, El Cajon		Market
SDG&E	ELCAJN_6_UNITA1	22150	EC GEN1	13.8	45.42	1	SD-IV	San Diego, El Cajon		Market
SDG&E	ENERSJ_2_WIND	23100	ECO GEN1 G1	0.69	32.57	G1	SD-IV		Aug NQC	Wind
SDG&E	ESCND0_6_EB1BT1	22256	ESCNDIDO	69	10.00	1	SD-IV	San Diego		Battery
SDG&E	ESCND0_6_EB2BT2	22256	ESCNDIDO	69	10.00	1	SD-IV	San Diego		Battery

Attachment A - List of physical resources by PTO, local area and market ID

SDG&E	ESCND0_6_EB3BT3	22256	ESCNDIDO	69	10.00	1	SD-IV	San Diego		Battery
SDG&E	ESCND0_6_PL1X2	22257	ESGEN	13.8	48.71	1	SD-IV	San Diego		Market
SDG&E	ESCND0_6_UNITB1	22153	CALPK_ES	13.8	48.04	1	SD-IV	San Diego		Market
SDG&E	ESCO_6_GLMQF	22332	GOALLINE	69	36.41	1	SD-IV	San Diego	Aug NQC	Net Seller
SDG&E	IVSLRP_2_SOLAR1	23440	DW GEN2 G1	0.36	54.00	1	SD-IV		Aug NQC	Solar
SDG&E	IWEST_2_SOLAR1	23155	DU GEN1 G1	0.2	21.91	G1	SD-IV		Aug NQC	Solar
SDG&E	IWEST_2_SOLAR1	23156	DU GEN1 G2	0.2	18.59	G2	SD-IV		Aug NQC	Solar
SDG&E	JACMSR_1_JACSR1	23352	ECO GEN2	0.55	5.40	1	SD-IV		Aug NQC	Solar
SDG&E	LAKHDG_6_UNIT 1	22625	LKHODG1	13.8	20.00	1	SD-IV	San Diego		Market
SDG&E	LAKHDG_6_UNIT 2	22626	LKHODG2	13.8	20.00	2	SD-IV	San Diego		Market
SDG&E	LARKSP_6_UNIT 1	22074	LRKSPBD1	13.8	46.00	1	SD-IV	San Diego, Border		Market
SDG&E	LARKSP_6_UNIT 2	22075	LRKSPBD2	13.8	46.00	1	SD-IV	San Diego, Border		Market
SDG&E	LAROA1_2_UNITA1	20187	LRP-U1	16	0.00	1	SD-IV		Connect to CENACE/CF E grid for the summer – not available for ISO BAA RA purpose	Market
SDG&E	LAROA2_2_UNITA1	22997	INTBCT	16	176.81	1	SD-IV			Market
SDG&E	LAROA2_2_UNITA1	22996	INTBST	18	145.19	1	SD-IV			Market
SDG&E	LILIAC_6_SOLAR	22404	LILIAC	69	0.81	DG	SD-IV	San Diego		Solar
SDG&E	MRGT_6_MEF2	22487	MEF_MR2	13.8	44.00	1	SD-IV	San Diego		Market
SDG&E	MRGT_6_MMAREF	22486	MEF_MR1	13.8	45.00	1	SD-IV	San Diego		Market
SDG&E	MSHGTS_6_MMARLF	22448	MESAHGTS	69	4.03	1	SD-IV	San Diego	Aug NQC	Market
SDG&E	MSSION_2_QF	22496	MISSION	69	0.70	1	SD-IV	San Diego	Aug NQC	Market
SDG&E	MURRAY_6_UNIT	22532	MURRAY	69	0.00		SD-IV	San Diego	Not modeled Energy Only	Market
SDG&E	OCTILO_5_WIND	23314	OCO GEN G1	0.69	27.83	G1	SD-IV		Aug NQC	Wind
SDG&E	OCTILO_5_WIND	23318	OCO GEN G2	0.69	27.83	G2	SD-IV		Aug NQC	Wind
SDG&E	OGROVE_6_PL1X2	22628	PA GEN1	13.8	48.00	1	SD-IV	San Diego		Market
SDG&E	OGROVE_6_PL1X2	22629	PA GEN2	13.8	48.00	1	SD-IV	San Diego		Market
SDG&E	OTAY_6_PL1X2	22617	OYGEN	13.8	35.50	1	SD-IV	San Diego		Market
SDG&E	OTMESA_2_PL1X3	22607	OTAYMST1	16	272.27	1	SD-IV	San Diego		Market
SDG&E	OTMESA_2_PL1X3	22606	OTAYMGT2	18	166.17	1	SD-IV	San Diego		Market

Attachment A - List of physical resources by PTO, local area and market ID

SDG&E	OTMESA_2_PL1X3	22605	OTAYMGT1	18	165.16	1	SD-IV	San Diego		Market
SDG&E	PALOMR_2_PL1X3	22265	PEN_ST	18	225.24	1	SD-IV	San Diego		Market
SDG&E	PALOMR_2_PL1X3	22262	PEN_CT1	18	170.18	1	SD-IV	San Diego		Market
SDG&E	PALOMR_2_PL1X3	22263	PEN_CT2	18	170.18	1	SD-IV	San Diego		Market
SDG&E	PIOPIC_2_CTG1	23162	PIO PICO CT1	13.8	111.30	1	SD-IV	San Diego	No NQC - Pmax	Market
SDG&E	PIOPIC_2_CTG2	23163	PIO PICO CT2	13.8	112.70	1	SD-IV	San Diego	No NQC - Pmax	Market
SDG&E	PIOPIC_2_CTG3	23164	PIO PICO CT3	13.8	112.00	1	SD-IV	San Diego	No NQC - Pmax	Market
SDG&E	PRCTVY_1_MIGBT1				0.00		SD-IV	San Diego	Aug NQC	Battery
SDG&E	SAMPSN_6_KELCO1	22704	SAMPSON	12.5	0.85	1	SD-IV	San Diego	Aug NQC	Net Seller
SDG&E	SLRMS3_2_SRMSR1	23442	DW GEN2 G3A	0.6	40.50	1	SD-IV		Aug NQC	Solar
SDG&E	SLRMS3_2_SRMSR1	23443	DW GEN2 G3B	0.6	27.00	1	SD-IV		Aug NQC	Solar
SDG&E	SMRCOS_6_LNDFIL	22724	SANMRCOS	69	1.50	1	SD-IV	San Diego	Aug NQC	Market
SDG&E	TERMEX_2_PL1X3	22981	TDM STG	21	280.13	1	SD-IV			Market
SDG&E	TERMEX_2_PL1X3	22982	TDM CTG2	18	156.44	1	SD-IV			Market
SDG&E	TERMEX_2_PL1X3	22983	TDM CTG3	18	156.44	1	SD-IV			Market
SDG&E	VLCNTR_6_VCCLR	22870	VALCNTR	69	0.63	DG	SD-IV	San Diego	Aug NQC	Solar
SDG&E	VLCNTR_6_VCCLR1	22870	VALCNTR	69	0.68	DG	SD-IV	San Diego	Aug NQC	Solar
SDG&E	VLCNTR_6_VCCLR2	22870	VALCNTR	69	1.35	DG	SD-IV	San Diego	Aug NQC	Solar
SDG&E	VSTAES_6_VESBT1	23541	ME GEN 1_BS1	0.64	5.50	1	SD-IV	San Diego	No NQC - est. data	Battery
SDG&E	VSTAES_6_VESBT1	23216	ME GEN 1_BS2	0.48	5.50	1	SD-IV	San Diego	No NQC - est. data	Battery
SDG&E	WISTRA_2_WRSSR1	23287	Q429_G1	0.31	27.00	1	SD-IV		Aug NQC	Solar
SDG&E	ZZ_NA	22916	PFC-AVC	0.6	0.00	1	SD-IV	San Diego	No NQC - hist. data	QF/Selfgen
SDG&E	ZZZ_New Unit	23710	Q1170_BESS	0.48	62.50	1	SD-IV	San Diego	No NQC - Pmax	Battery
SDG&E	ZZZ_New Unit	23441	DW GEN6	0.42	40.58	1	SD-IV		No NQC - est. data	Solar

Attachment A - List of physical resources by PTO, local area and market ID

SDG&E	ZZZ_New Unit	22020	AVOCADO	69	40.00	S2	SD-IV	San Diego	No NQC - Pmax	Battery
SDG&E	ZZZ_New Unit	23544	Q1169_BESS1	0.4	35.00	C8	SD-IV	San Diego	No NQC - Pmax	Battery
SDG&E	ZZZ_New Unit	23519	Q1169_BESS2	0.4	35.00	C8	SD-IV	San Diego	No NQC - Pmax	Battery
SDG&E	ZZZ_New Unit	23412	Q1434_G	0.64	30.00	1	SD-IV	San Diego	No NQC - Pmax	Battery
SDG&E	ZZZ_New Unit	22942	BUE GEN 1_G1	0.69	11.60	G1	SD-IV		No NQC - est. data	Wind
SDG&E	ZZZ_New Unit	22945	BUE GEN 1_G2	0.69	11.60	G2	SD-IV		No NQC - est. data	Wind
SDG&E	ZZZ_New Unit	22947	BUE GEN 1_G3	0.69	11.60	G3	SD-IV		No NQC - est. data	Wind
SDG&E	ZZZ_New Unit	22256	ESCNDIDO	69	6.50	S2	SD-IV	San Diego	No NQC - Pmax	Battery
SDG&E	ZZZ_New Unit	22112	CAPSTRNO	138	5.90	1	SD-IV	San Diego	No NQC - Pmax	Battery
SDG&E	ZZZ_New Unit	22112	CAPSTRNO	138	4.00	S2	SD-IV	San Diego	No NQC - Pmax	Battery
SDG&E	ZZZ_New Unit	23597	Q1175_BESS	0.48	0.00	1	SD-IV		Energy Only	Battery
SDG&E	ZZZ_New Unit	22404	LILAC	69	0.00	S2	SD-IV	San Diego	Energy Only	Battery
SDG&E	ZZZ_New Unit	22512	MONSRATE	69	0.00	S2	SD-IV	San Diego	Energy Only	Battery
SDG&E	ZZZZ_New Unit	23421	Q1531_BESS1	0.55	116.50	11	SD-IV		No NQC - Pmax	Battery
SDG&E	ZZZZ_New Unit	23425	Q1531_BESS2	0.55	116.50	11	SD-IV		No NQC - Pmax	Battery
SDG&E	ZZZZ_New Unit	23429	Q1531_BESS3	0.55	116.50	11	SD-IV		No NQC - Pmax	Battery
SDG&E	ZZZZ_New Unit	23398	Q1166_G	0.41	55.68	1	SD-IV		No NQC - 87%Pmax	Battery
SDG&E	ZZZZ_New Unit	22484	MIRAMAR1	69	30.00	S2	SD-IV	San Diego	No NQC - Pmax	Battery
SDG&E	ZZZZ_New Unit	23231	Q1432_G	0.39	8.10	1	SD-IV	San Diego	No NQC - est. data	Solar
SDG&E	ZZZZ_New Unit	22970	Q1532_GEN	0.6	5.40	1	SD-IV	San Diego	No NQC - est. data	Solar
SDG&E	ZZZZ_New Unit	23585	Q838_G1	0.6	4.32	1	SD-IV		No NQC - est. data	Solar

Attachment A - List of physical resources by PTO, local area and market ID

SDG&E	ZZZZ_New Unit	23586	Q838_G2	0.6	4.32	1	SD-IV		No NQC - est. data	Solar
SDG&E	ZZZZ_New Unit	22949	BUE GEN 1_G4	0.69	0.00	1	SD-IV		Energy Only	Wind
SDG&E	ZZZZZ_CBRLLO_6_PLST P1	22092	CABRILLO	69	0.00	1	SD-IV	San Diego	Aug NQC	Market
SDG&E	ZZZZZ_DIVSON_6_NSQF	22172	DIVISION	69	0.00	1	SD-IV	San Diego	Retired	QF/Selfgen
SDG&E	ZZZZZ_ELCAJN_7_GT1	22212	ELCAJNGT	12.5	0.00	1	SD-IV	San Diego, El Cajon	Retired	Market
SDG&E	ZZZZZ_ENCINA_7_EA1	22233	ENCINA 1	14.4	0.00	1	SD-IV	San Diego	Retired	Market
SDG&E	ZZZZZ_ENCINA_7_EA2	22234	ENCINA 2	14.4	0.00	1	SD-IV	San Diego	Retired by 2019	Market
SDG&E	ZZZZZ_ENCINA_7_EA3	22236	ENCINA 3	14.4	0.00	1	SD-IV	San Diego	Retired by 2019	Market
SDG&E	ZZZZZ_ENCINA_7_EA4	22240	ENCINA 4	22	0.00	1	SD-IV	San Diego	Retired by 2019	Market
SDG&E	ZZZZZ_ENCINA_7_EA5	22244	ENCINA 5	24	0.00	1	SD-IV	San Diego	Retired by 2019	Market
SDG&E	ZZZZZ_ENCINA_7_GT1	22248	ENCINAGT	12.5	0.00	1	SD-IV	San Diego	Retired by 2019	Market
SDG&E	ZZZZZ_KEARNY_7_KY2	22373	KEARN2AB	12.5	0.00	1	SD-IV	San Diego	Retired	Market
SDG&E	ZZZZZ_KEARNY_7_KY2	22374	KEARN2CD	12.5	0.00	1	SD-IV	San Diego	Retired	Market
SDG&E	ZZZZZ_KEARNY_7_KY2	22373	KEARN2AB	12.5	0.00	2	SD-IV	San Diego	Retired	Market
SDG&E	ZZZZZ_KEARNY_7_KY2	22374	KEARN2CD	12.5	0.00	2	SD-IV	San Diego	Retired	Market
SDG&E	ZZZZZ_KEARNY_7_KY3	22375	KEARN3AB	12.5	0.00	1	SD-IV	San Diego	Retired	Market
SDG&E	ZZZZZ_KEARNY_7_KY3	22376	KEARN3CD	12.5	0.00	1	SD-IV	San Diego	Retired	Market
SDG&E	ZZZZZ_KEARNY_7_KY3	22375	KEARN3AB	12.5	0.00	2	SD-IV	San Diego	Retired	Market
SDG&E	ZZZZZ_KEARNY_7_KY3	22376	KEARN3CD	12.5	0.00	2	SD-IV	San Diego	Retired	Market
SDG&E	ZZZZZ_MRGT_7_UNITS	22488	MIRAMRGT	12.5	0.00	1	SD-IV	San Diego	Retired	Market

Attachment A - List of physical resources by PTO, local area and market ID

SDG&E	ZZZZ_MRGT_7_UNITS	22488	MIRAMRGT	12.5	0.00	2	SD-IV	San Diego	Retired	Market
SDG&E	ZZZZ_NIMTG_6_NIQF	22576	NOISLMTR	69	0.00	1	SD-IV	San Diego	Retired	QF/Selfgen
SDG&E	ZZZZ_OTAY_6_LNDFL5	22604	OTAY	69	0.00		SD-IV	San Diego	Retired	Market
SDG&E	ZZZZ_OTAY_6_LNDFL6	22604	OTAY	69	0.00		SD-IV	San Diego	Retired	Market
SDG&E	ZZZZ_OTAY_6_UNITB1	22604	OTAY	69	0.00	1	SD-IV	San Diego	Retired	Market
SDG&E	ZZZZ_OTAY_7_UNITC1	22604	OTAY	69	0.00	3	SD-IV	San Diego	Aug NQC	QF/Selfgen
SDG&E	ZZZZ_PTLOMA_6_NTCCGN	22660	POINTLMA	69	0.00	2	SD-IV	San Diego	Retired	QF/Selfgen
SDG&E	ZZZZ_PTLOMA_6_NTCQF	22660	POINTLMA	69	0.00	1	SD-IV	San Diego	Retired	QF/Selfgen

o

Attachment B – Effectiveness factors for procurement guidance

Table - Eagle Rock.

Effectiveness factors to the Eagle Rock-Cortina 115 kV line:

Gen Bus	Gen Name	Gen ID	Eff Fctr (%)
31406	GEYSR5-6	1	36
31406	GEYSR5-6	2	36
31408	GEYSER78	1	36
31408	GEYSER78	2	36
31412	GEYSER11	1	37
31435	GEO.ENGY	1	35
31435	GEO.ENGY	2	35
31433	POTTRVLY	1	34
31433	POTTRVLY	3	34
31433	POTTRVLY	4	34
38020	CITY UKH	1	32
38020	CITY UKH	2	32

Table - Fulton

Effectiveness factors to the Lakeville-Petaluma-Cotati 60 kV line:

Gen Bus	Gen Name	Gen ID	Eff Fctr (%)
31466	SONMA LF	1	52
31422	GEYSER17	1	12
31404	WEST FOR	1	12
31404	WEST FOR	2	12
31414	GEYSER12	1	12
31418	GEYSER14	1	12
31420	GEYSER16	1	12
31402	BEAR CAN	1	12
31402	BEAR CAN	2	12

Attachment B - Effectiveness factors for procurement guidance

Gen Bus	Gen Name	Gen ID	Eff Fctr (%)
38110	NCPA2GY1	1	12
38112	NCPA2GY2	1	12
32700	MONTICLO	1	10
32700	MONTICLO	2	10
32700	MONTICLO	3	10
31435	GEO.ENGY	1	6
31435	GEO.ENGY	2	6
31408	GEYSER78	1	6
31408	GEYSER78	2	6
31412	GEYSER11	1	6
31406	GEYSR5-6	1	6
31406	GEYSR5-6	2	6

Table - Lakeville

Effectiveness factors to the Vaca Dixon-Lakeville 230 kV line:

Gen Bus	Gen Name	Gen ID	Eff Fctr (%)
31400	SANTA FE	2	38
31430	SMUDGE01	1	38
31400	SANTA FE	1	38
31416	GEYSER13	1	38
31424	GEYSER18	1	38
31426	GEYSER20	1	38
38106	NCPA1GY1	1	38
38108	NCPA1GY2	1	38
31421	BOTTLERK	1	36
31404	WEST FOR	2	36
31402	BEAR CAN	1	36
31402	BEAR CAN	2	36
31404	WEST FOR	1	36
31414	GEYSER12	1	36
31418	GEYSER14	1	36
31420	GEYSER16	1	36

Attachment B - Effectiveness factors for procurement guidance

Gen Bus	Gen Name	Gen ID	Eff Fctr (%)
31422	GEYSER17	1	36
38110	NCPA2GY1	1	36
38112	NCPA2GY2	1	36
31446	SONMA LF	1	36
32700	MONTICLO	1	31
32700	MONTICLO	2	31
32700	MONTICLO	3	31
31406	GEYSR5-6	1	18
31406	GEYSR5-6	2	18
31405	RPSP1014	1	18
31408	GEYSER78	1	18
31408	GEYSER78	2	18
31412	GEYSER11	1	18
31435	GEO.ENGY	1	18
31435	GEO.ENGY	2	18
31433	POTTRVLY	1	15
31433	POTTRVLY	2	15
31433	POTTRVLY	3	15
38020	CITY UKH	1	15
38020	CITY UKH	2	15

Table – Rio Oso

Effectiveness factors to the Rio Oso-Atlantic 230 kV line:

Gen Bus	Gen Name	Gen ID	Eff Fctr. (%)
32498	SPILINCF	1	49
32500	ULTR RCK	1	49
32456	MIDLFORK	1	33
32456	MIDLFORK	2	33
32458	RALSTON	1	33

Attachment B - Effectiveness factors for procurement guidance

32513	ELDRADO1	1	32
32514	ELDRADO2	1	32
32510	CHILIBAR	1	32
32486	HELLHOLE	1	31
32508	FRNCH MD	1	30
32460	NEWCASTLE	1	26
32478	HALSEY F	1	24
32512	WISE	1	24
38114	Stig CC	1	14
38123	Q267CT	1	14
38124	Q267ST	1	14
32462	CHI.PARK	1	8
32464	DTCHFLT1	1	4

Table – South of Table Mountain

Effectiveness factors to the Caribou-Palermo 115 kV line:

Gen Bus	Gen Name	Gen ID	Eff Fctr. (%)
31814	FORBSTWN	1	7
31794	WOODLEAF	1	7
31832	SLY.CR.	1	7
31862	DEADWOOD	1	7
31890	PO POWER	1	6
31890	PO POWER	2	6
31888	OROVILLE	1	6
31834	KELLYRDG	1	6
32450	COLGATE1	1	4

Attachment B - Effectiveness factors for procurement guidance

Gen Bus	Gen Name	Gen ID	Eff Fctr. (%)
32466	NARROWS1	1	4
32468	NARROWS2	1	4
32452	COLGATE2	1	4
32470	CMP.FARW	1	4
32451	FREC	1	4
32490	GRNLEAF1	1	4
32490	GRNLEAF1	2	4
32496	YCEC	1	4
32494	YUBA CTY	1	4
32492	GRNLEAF2	1	4
32498	SPILINCF	1	2
31788	ROCK CK2	1	2
31812	CRESTA	1	2
31812	CRESTA	2	2
31820	BCKS CRK	1	2
31820	BCKS CRK	2	2
31786	ROCK CK1	1	2
31790	POE 1	1	2
31792	POE 2	1	2
31784	BELDEN	1	2
32500	ULTR RCK	1	2
32156	WOODLAND	1	2
32510	CHILIBAR	1	2
32513	ELDRADO1	1	2
32514	ELDRADO2	1	2
32478	HALSEY F	1	2
32460	NEWCASTLE	1	1

Attachment B - Effectiveness factors for procurement guidance

Gen Bus	Gen Name	Gen ID	Eff Fctr. (%)
32458	RALSTON	1	1
32512	WISE	1	1
32456	MIDLFORK	1	1
32456	MIDLFORK	2	1
32486	HELLHOLE	1	1
32508	FRNCH MD	1	1
32162	RIV.DLTA	1	1
32502	DTCHFLT2	1	1
32462	CHI.PARK	1	1
32464	DTCHFLT1	1	1
32454	DRUM 5	1	1
32476	ROLLINSF	1	1
32484	OXBOW F	1	1
32474	DEER CRK	1	1
32504	DRUM 1-2	1	1
32504	DRUM 1-2	2	1
32506	DRUM 3-4	1	1
32506	DRUM 3-4	2	1
32166	UC DAVIS	1	1
32472	SPAULDG	1	1
32472	SPAULDG	2	1
32472	SPAULDG	3	1
32480	BOWMAN	1	1
32488	HAYPRES+	1	1
32488	HAYPRES+	2	1
38124	LODI ST1	1	1
38123	LODI CT1	1	1

Attachment B - Effectiveness factors for procurement guidance

Gen Bus	Gen Name	Gen ID	Eff Fctr. (%)
38114	STIG CC	1	1

Table – San Jose

Effectiveness factors to the Newark-NRS 115 kV line:

Gen Bus	Gen Name	Gen ID	Eff Fctr (%)
36895	Gia200	1	25
36858	Gia100	1	25
36859	Laf300	2	23
36859	Laf300	1	23
36863	DVRaGT1	1	23
36864	DVRbGt2	1	23
36865	DVRaST3	1	23
35854	LECEFGT1	1	19
35855	LECEFGT2	1	19
35856	LECEFGT3	1	19
35857	LECEFGT4	1	19
35858	LECEFST1	1	19
35860	OLS-AGNE	1	19
35863	CATALYST	1	12

Table – South Bay-Moss Landing

Effectiveness factors to the Moss Landing-Las Aguillas 230 kV line:

Gen Bus	Gen Name	Gen ID	Eff Fctr. (%)
36209	SLD ENRG	1	20
36221	DUKMOSS1	1	20
36222	DUKMOSS2	1	20
36223	DUKMOSS3	1	20
36224	DUKMOSS4	1	20

Attachment B - Effectiveness factors for procurement guidance

36225	DUKMOSS5	1	20
36226	DUKMOSS6	1	20
36405	MOSSLND6	1	17
36406	MOSSLND7	1	17
35881	MEC CTG1	1	13
35882	MEC CTG2	1	13
35883	MEC STG1	1	13
35850	GLRY COG	1	12
35850	GLRY COG	2	12
35851	GROYPKR1	1	12
35852	GROYPKR2	1	12
35853	GROYPKR3	1	12
35623	SWIFT	BT	10
35863	CATALYST	1	10
36863	DVRaGT1	1	8
36864	DVRbGt2	1	8
36865	DVRaST3	1	8
36859	Laf300	2	8
36859	Laf300	1	8
36858	Gia100	1	7
36895	Gia200	1	7
35854	LECEFGT1	1	7
35855	LECEFGT2	1	7
35856	LECEFGT3	1	7
35857	LECEFGT4	1	7

Attachment B - Effectiveness factors for procurement guidance

35858	LECEFST1	1	7
35860	OLS-AGNE	1	7

Table – Ames/Pittsburg/Oakland

Effectiveness factors to the Ames-Ravenswood #1 115 kV line:

Gen Bus	Gen Name	Gen ID	Eff Fctr. (%)
35304	RUSELCT1	1	10
35305	RUSELCT2	2	10
35306	RUSELST1	3	10
33469	OX_MTN	1	10
33469	OX_MTN	2	10
33469	OX_MTN	3	10
33469	OX_MTN	4	10
33469	OX_MTN	5	10
33469	OX_MTN	6	10
33469	OX_MTN	7	10
33107	DEC STG1	1	3
33108	DEC CTG1	1	3
33109	DEC CTG2	1	3
33110	DEC CTG3	1	3
33102	COLUMBIA	1	3
33111	LMECCT2	1	3
33112	LMECCT1	1	3
33113	LMECST1	1	3
33151	FOSTER W	1	2

Attachment B - Effectiveness factors for procurement guidance

33151	FOSTER W	2	2
33151	FOSTER W	3	2
33136	CCCSD	1	2
33141	SHELL 1	1	2
33142	SHELL 2	1	2
33143	SHELL 3	1	2
32900	CRCKTCOG	1	2
32910	UNOCAL	1	2
32910	UNOCAL	2	2
32910	UNOCAL	3	2
32920	UNION CH	1	2
32921	ChevGen1	1	2
32922	ChevGen2	1	2
32923	ChevGen3	3	2
32741	HILLSIDE_12	1	2
32901	OAKLND 1	1	1
32902	OAKLND 2	2	1
32903	OAKLND 3	3	1
38118	ALMDACT1	1	1
38119	ALMDACT2	1	1

Effectiveness factors to the Moraga-C Claremont #2 115 kV line:

Gen Bus	Gen Name	Gen ID	Eff Fctr. (%)
32741	HILLSIDE_12	1	15
32921	ChevGen1	1	15

Attachment B - Effectiveness factors for procurement guidance

32922	ChevGen2	1	15
32923	ChevGen3	3	15
32920	UNION CH	1	14
32910	UNOCAL	1	13
32910	UNOCAL	2	13
32910	UNOCAL	3	13
32901	OAKLND 1	1	10
32902	OAKLND 2	2	10
32903	OAKLND 3	3	10
38118	ALMDACT1	1	10
38119	ALMDACT2	1	10
33141	SHELL 1	1	9
33142	SHELL 2	1	9
33143	SHELL 3	1	9
33136	CCCSD	1	8
32900	CRCKTCOG	1	7
33151	FOSTER W	1	6
33151	FOSTER W	2	6
33151	FOSTER W	3	6
33102	COLUMBIA	1	3
33111	LMECCT2	1	3
33112	LMECCT1	1	3
33113	LMECST1	1	3
33107	DEC STG1	1	3
33108	DEC CTG1	1	3

Attachment B - Effectiveness factors for procurement guidance

33109	DEC CTG2	1	3
33110	DEC CTG3	1	3

Table – Herndon

Effectiveness factors to the Herndon-Manchester 115 kV line:

Gen Bus	Gen Name	Gen ID	Eff Fctr. (%)
34624	BALCH 1	1	22
34616	KINGSRIV	1	21
34648	DINUBA E	1	20
34671	KRCDPCT1	1	19
34672	KRCDPCT2	1	19
34308	KERCKHOF	1	17
34343	KERCK1-2	2	17
34344	KERCK1-1	1	17
34345	KERCK1-3	3	17
34603	JGBSWLT	ST	15
34677	Q558	1	15
34690	CORCORAN_3	FW	15
34692	CORCORAN_4	FW	15
34696	CORCORANPV_S	1	15
34699	Q529	1	15
34610	HAAS	1	13
34610	HAAS	2	13
34612	BLCH 2-2	1	13
34614	BLCH 2-3	1	13

Attachment B - Effectiveness factors for procurement guidance

34431	GWF_HEP1	1	8
34433	GWF_HEP2	1	8
34617	Q581	1	5
34649	Q965	1	5
34680	KANSAS	1	5
34467	GIFFEN_DIST	1	4
34563	STROUD_DIST	2	4
34563	STROUD_DIST	1	4
34608	AGRICO	2	4
34608	AGRICO	3	4
34608	AGRICO	4	4
34644	Q679	1	4
36550	Q632BC1	1	4

Table – LA Basin

Effectiveness factors to the Mesa – Laguna Bell #1 230 kV line:

Gen Bus	Gen Name	Gen ID	Eff Fctr. (%)
29951	REFUSE	D1	35
24239	MALBRG1G	C1	34
24240	MALBRG1G	C2	34
24241	MALBRG1G	S3	34
29903	ELSEG6ST	6	27
29904	ELSEG5GT	5	27
29902	ELSEG7ST	7	27
29901	ELSEG8GT	8	27

Attachment B - Effectiveness factors for procurement guidance

24337	VENICE	1	26
24094	MOBGEN1	1	26
24329	MOBGEN2	1	26
24332	PALOGEN	D1	26
24011	ARCO 1G	1	23
24012	ARCO 2G	2	23
24013	ARCO 3G	3	23
24014	ARCO 4G	4	23
24163	ARCO 5G	5	23
24164	ARCO 6G	6	23
24062	HARBOR G	1	23
24062	HARBOR G	HP	23
25510	HARBORG4	LP	23
24327	THUMSGEN	1	23
24020	CARBGEN1	1	23
24328	CARBGEN2	1	23
24139	SERRFGEN	D1	23
24070	ICEGEN	1	22
24001	ALAMT1 G	1	18
24002	ALAMT2 G	2	18
24003	ALAMT3 G	3	18
24004	ALAMT4 G	4	18
24005	ALAMT5 G	5	18
24161	ALAMT6 G	6	18
90000	ALMT-GT1	X1	18

Attachment B - Effectiveness factors for procurement guidance

90001	ALMT-GT2	X2	18
90002	ALMT-ST1	X3	18
29308	CTRPKGEN	1	18
29953	SIGGEN	D1	18
29309	BARPKGEN	1	13
29201	WALCRKG1	1	12
29202	WALCRKG2	1	12
29203	WALCRKG3	1	12
29204	WALCRKG4	1	12
29205	WALCRKG5	1	12
29011	BREAPWR2	C1	12
29011	BREAPWR2	C2	12
29011	BREAPWR2	C3	12
29011	BREAPWR2	C4	12
29011	BREAPWR2	S1	12
24325	ORCOGEN	I	12
24341	COYGEN	I	11
25192	WDT1406_G	I	11
25208	DowlingCTG	1	10
25211	CanyonGT 1	1	10
25212	CanyonGT 2	2	10
25213	CanyonGT 3	3	10
25214	CanyonGT 4	4	10
24216	VILLA PK	DG	9

Attachment B - Effectiveness factors for procurement guidance

Table – Rector

Effectiveness factors to the Rector-Vestal 230 kV line:

Gen Bus	Gen Name	Gen ID	MW Eff Fctr (%)
24370	KAWGEN	1	51
24306	B CRK1-1	1	45
24306	B CRK1-1	2	45
24307	B CRK1-2	3	45
24307	B CRK1-2	4	45
24319	EASTWOOD	1	45
24323	PORTAL	1	45
24308	B CRK2-1	1	45
24308	B CRK2-1	2	45
24309	B CRK2-2	3	45
24309	B CRK2-2	4	45
24310	B CRK2-3	5	45
24310	B CRK2-3	6	45
24315	B CRK 8	81	45
24315	B CRK 8	82	45
24311	B CRK3-1	1	45
24311	B CRK3-1	2	45
24312	B CRK3-2	3	45
24312	B CRK3-2	4	45
24313	B CRK3-3	5	45
24317	MAMOTH1G	1	45
24318	MAMOTH2G	2	45
24314	B CRK 4	41	43
24314	B CRK 4	42	43

Attachment B - Effectiveness factors for procurement guidance

Table – San Diego

Effectiveness factors to the Imperial Valley – El Centro 230 kV line (i.e., the “S” line):

Gen Bus	Gen Name	Gen ID	Eff Fctr. (%)
22982	TDM CTG2	1	25
22983	TDM CTG3	1	25
22981	TDM STG	1	25
22997	INTBCT	1	25
22996	INTBST	1	25
23440	DW GEN2 G1	1	25
23298	DW GEN1 G1	G1	25
23156	DU GEN1 G2	G2	25
23299	DW GEN1 G2	G2	25
23155	DU GEN1 G1	G1	25
23441	DW GEN2 G2	1	25
23442	DW GEN2 G3A	1	25
23443	DW GEN2 G3B	1	25
23314	OCO GEN G1	G1	23
23318	OCO GEN G2	G2	23
23100	ECO GEN1 G	G1	22
23352	ECO GEN2 G	1	21
22605	OTAYMGT1	1	18
22606	OTAYMGT2	1	18
22607	OTAYMST1	1	18
23162	PIO PICO CT1	1	18
23163	PIO PICO CT2	1	18

Attachment B - Effectiveness factors for procurement guidance

23164	PIO PICO CT3	1	18
22915	KUMEYAAY	1	17
23320	EC GEN2	1	17
22150	EC GEN1	1	17
22617	OY GEN	1	17
22604	OTAY	1	17
22604	OTAY	3	17
22172	DIVISION	1	17
22576	NOISLMTR	1	17
22704	SAMPSON	1	17
22092	CABRILLO	1	17
22074	LRKSPBD1	1	17
22075	LRKSPBD2	1	17
22660	POINTLMA	1	17
22660	POINTLMA	2	17
22149	CALPK_BD	1	17
22448	MESAHGTS	1	16
22120	CARLTNHS	1	16
22120	CARLTNHS	2	16
22496	MISSION	1	16
22486	MEF MR1	1	16
22124	CHCARITA	1	16
22487	MEF MR2	1	16
22625	LkHodG1	1	16
22626	LkHodG2	2	16

Attachment B - Effectiveness factors for procurement guidance

22332	GOALLINE	1	15
22262	PEN_CT1	1	15
22153	CALPK_ES	1	15
22786	EA GEN1 U6	1	15
22787	EA GEN1 U7	1	15
22783	EA GEN1 U8	1	15
22784	EA GEN1 U9	1	15
22789	EA GEN1 U10	1	15
22257	ES GEN	1	15
22263	PEN_CT2	1	15
22265	PEN_ST	1	15
22724	SANMRCOS	1	15
22628	PA GEN1	1	14
22629	PA GEN2	1	14
22082	BR GEN1	1	14
22112	CAPSTRNO	1	12