

2029 LOCAL CAPACITY TECHNICAL STUDY

FINAL REPORT AND STUDY RESULTS

Intentionally left blank

Executive Summary

This Report documents the results and recommendations of the 2029 Long-Term Local Capacity Technical (LCT) Study. The LCT Study assumptions, processes, and criteria were discussed and recommended through the 2025 Local Capacity Technical Study Criteria, Methodology and Assumptions Stakeholder Meeting held on October 30, 2023. On balance, the assumptions, processes, and criteria used for the 2029 Long-Term LCT Study mirror those used in the 2007-2024 LCT Studies.

The load forecast used in this study is based on the final adopted California Energy Demand 2023-2040 Forecast developed by the CEC; namely the CED 2023 Local Reliability LSE and BAA tables: <https://efiling.energy.ca.gov/GetDocument.aspx?tn=254424>.

To aide procurement, this LCT study provides load profiles and transmission capacity information that shows the effectiveness of local resources in meeting temporal local reliability needs.

Overall, the capacity needed for LCR has decreased by about 1364 MW or about 5.8% from 2028 to 2029.

The LCR needs have decreased in the following areas: Stockton and San Diego/Imperial Valley due to load forecast decrease, North Coast/North Bay, Bay Area and Fresno due to new transmissison projects, Kern and LA Basin due to load forecast decrease and new transmission projects.

The LCR needs have increased in the following areas: Humboldt and Big Creek/Ventura due to load forecast increase, Sierra due to load forecast increase and the flow-through nature of the area.

The narrative for each Local Capacity Area lists important new projects included in the base cases as well as a description of reason for changes between the 2028 and 2029 LCT study results.

The 2028 and 2029 total LCR needs are provided below for comparison:

2029 Local Capacity Needs

Local Area Name	Qualifying Capacity				Capacity Available at Peak	2029 LCR Need Category C
	QF/ Muni (MW)	Non-Solar (MW)	Solar (MW)	Total (MW)	Total (MW)	Capacity Needed
Humboldt	0	175	0	175	175	173
North Coast/ North Bay	136	849	0	985	985	650
Sierra	1221	704	0	1925	1925	1885*
Stockton	101	655	7	763	756	763*
Greater Bay	604	7781	4	8389	8385	6259
Greater Fresno	229	2839	199	3267	3068	2512*
Kern	9	397	43	449	406	241
Big Creek/ Ventura	399	3702	249	4350	4350	1329
LA Basin	1157	9129	10	10296	10296	5076
San Diego/ Imperial Valley	3	5637	169	5809	5809	3121
Total	3859	31868	681	36408	36155	22009

2028 Local Capacity Needs

Local Area Name	Qualifying Capacity				Capacity Available at Peak	2028 LCR Need Category C
	QF/ Muni (MW)	Non-Solar (MW)	Solar (MW)	Total (MW)	Total (MW)	Capacity Needed
Humboldt	0	176	0	176	176	148
North Coast/ North Bay	137	852	0	989	989	891
Sierra	1197	686	0	1883	1883	1415*
Stockton	106	659	7	772	765	772*
Greater Bay	617	7327	4	7948	7944	6261
Greater Fresno	206	2740	181	3127	2946	2728*
Kern	10	374	43	427	384	427
Big Creek/ Ventura	406	3446	265	4117	4117	1216
LA Basin	1179	7164	10	8353	8353	5940
San Diego/ Imperial Valley	2	5204	182	5388	5206	3575
Total	3860	28628	692	33180	32763	23373

* Details about magnitude of deficiencies can be found in the applicable section below. Resource deficient sub-area implies that in order to comply with the criteria, at summer peak, load may be shed immediately after the first contingency.

Intentionally left blank

Table of Contents

Executive Summary.....	1
1 Overview of the Study: Inputs, Outputs and Options.....	6
1.1 Objectives.....	6
1.2 Key Study Assumptions.....	6
1.2.1 Inputs, Assumptions and Methodology	6
1.3 Grid Reliability.....	8
1.4 Application of N-1, N-1-1, and N-2 Criteria.....	8
1.5 Performance Criteria.....	9
1.5.1 Performance Criteria.....	9
1.5.2 CAISO Statutory Obligation Regarding Safe Operation.....	10
2 Assumption Details: How the Study was Conducted.....	14
2.1 System Planning Criteria.....	14
2.1.1 Power Flow Assessment.....	17
2.1.2 Post Transient Load Flow Assessment.....	18
2.1.3 Stability Assessment.....	18
2.2 Load Forecast.....	18
2.2.1 System Forecast.....	18
2.2.2 Base Case Load Development Method	18
2.3 Power Flow Program Used in the LCR analysis.....	20
2.4 Estimate of Battery Storage Needs due to Charging Constraints	20
3 Locational Capacity Requirement Study Results.....	22
3.1 Summary of Study Results.....	22
3.2 Summary of Results by Local Area.....	25
3.2.1 Humboldt Area	25
3.2.2 North Coast / North Bay Area.....	28
3.2.3 Sierra Area.....	36
3.2.4 Stockton Area.....	43
3.2.5 Greater Bay Area.....	50
3.2.6 Greater Fresno Area.....	66
3.2.7 Kern Area.....	83
3.2.8 Big Creek/Ventura Area	92
3.2.9 LA Basin Area	100
3.2.10 San Diego-Imperial Valley Area	110
3.2.11 Valley Electric Area.....	118
Attachment A - List of physical resources accounted for in the 2025 and 2029 Local Capacity Technical studies	119
Attachment B – Effectiveness factors for procurement guidance.....	120

Intentionally left blank

1 Overview of the Study: Inputs, Outputs and Options

1.1 Objectives

The intent of the 2029 Long-Term LCT Study is to identify specific areas within the CAISO Balancing Authority Area that have limited import capability and determine the minimum generation capacity (MW) necessary to mitigate the local reliability problems in those areas, as was the objective of all previous Local Capacity Technical Studies.

To aide procurement, this LCT study provides load profiles and transmission capacity information that shows the effectiveness of local resources in meeting temporal local reliability needs.

1.2 Key Study Assumptions

1.2.1 Inputs, Assumptions and Methodology

The inputs, assumptions and methodology were discussed and agreed to by stakeholders at the 2025 LCT Study Criteria, Methodology and Assumptions Stakeholder Meeting held on October 30, 2023. They are similar to those used and incorporated in previous LCT studies. The following table sets forth a summary of the approved inputs and methodology that have been used in this 2029 Long-Term LCT Study:

Table 1.2-1 Summary Table of Inputs and Methodology Used in this LCT Study:

Issue	How Incorporated into this LCT Study:
Input Assumptions:	
Transmission System Configuration	The existing transmission system has been modeled, including all projects operational on or before June 1, of the study year and all other feasible operational solutions brought forth by the PTOs and as agreed to by the CAISO.
Generation Modeled	The existing generation resources has been modeled and also includes all projects that will be on-line and commercial on or before June 1, of the study year
Load Forecast	Uses a 1-in-10 year summer peak load forecast
Methodology:	

Maximize Import Capability	Import capability into the load pocket has been maximized, thus minimizing the generation required in the load pocket to meet applicable reliability requirements.
QF/Nuclear/State/Federal Units	Regulatory Must-take and similarly situated units like QF/Nuclear/State/Federal resources have been modeled on-line at qualifying capacity output values for purposes of this LCT Study.
Maintaining Path Flows	Path flows have been maintained below all established path ratings into the load pockets, including the 500 kV. For clarification, given the existing transmission system configuration, the only 500 kV path that flows directly into a load pocket and will, therefore, be considered in this LCT Study is the South of Lugo transfer path flowing into the LA Basin.
Performance Criteria:	
All Performance Levels, including incorporation of PTO operational solutions	This LCT Study is being published based on the most stringent of all mandatory reliability standards. In addition, the CAISO will incorporate all new projects and other feasible and CAISO-approved operational solutions brought forth by the PTOs that can be operational on or before June 1, of the study year. Any such solutions that can reduce the need for procurement to meet the mandatory standards will be incorporated into the LCT Study.
Load Pocket:	
Fixed Boundary, including limited reference to published effectiveness factors	This LCT Study has been produced based on load pockets defined by a fixed boundary. The CAISO only publishes effectiveness factors where they are useful in facilitating procurement where excess capacity exists within a load pocket.

Further details regarding the 2029 Long-Term LCT Study methodology and assumptions are provided in Section III, below.

1.3 Grid Reliability

Service reliability builds from grid reliability because grid reliability is reflected in the Reliability Standards of the North American Electric Reliability Council (NERC) and the Western Electricity Coordinating Council (“WECC”) Regional Criteria (collectively “Reliability Standards”). The Reliability Standards apply to the interconnected electric system in the United States and are intended to address the reality that within an integrated network, whatever one Balancing Authority Area does can affect the reliability of other Balancing Authority Areas. Consistent with the mandatory nature of the Reliability Standards, the CAISO is under a statutory obligation to ensure efficient use and reliable operation of the transmission grid consistent with achievement of the Reliability Standards.¹ The CAISO is further under an obligation, pursuant to its FERC-approved Transmission Control Agreement, to secure compliance with all “Applicable Reliability Criteria.” Applicable Reliability Criteria consists of the Reliability Standards as well as reliability criteria adopted by the CAISO (Grid Planning Standards).

The Reliability Standards define reliability on interconnected electric systems using the terms “adequacy” and “security.” “Adequacy” is the ability of the electric systems to supply the aggregate electrical demand and energy requirements of their customers at all times, taking into account physical characteristics of the transmission system such as transmission ratings and scheduled and reasonably expected unscheduled outages of system elements. “Security” is the ability of the electric systems to withstand sudden disturbances such as electric short circuits or unanticipated loss of system elements. The Reliability Standards are organized by Performance Categories. Certain categories require that the grid operator not only ensure that grid integrity is maintained under certain adverse system conditions (e.g., security), but also that all customers continue to receive electric supply to meet demand (e.g., adequacy). In that case, grid reliability and service reliability would overlap. But there are other levels of performance where security can be maintained without ensuring adequacy.

1.4 Application of N-1, N-1-1, and N-2 Criteria

The CAISO will maintain the system in a safe operating mode at all times. This obligation translates into respecting the Reliability Criteria at all times, for example during normal operating conditions (N-0) the CAISO must protect for all single contingencies (N-1) and common mode (N-2) double line outages. Also, after a single contingency, the CAISO must re-adjust the system to support the loss of the next most stringent contingency. This is referred to as the N-1-1 condition.

The N-1-1 vs N-2 terminology was introduced only as a temporal differentiation between two existing NERC Category P6 and P7 events. N-1-1 represents NERC Category C6 (“category P1 contingency, manual system adjustment, followed by another category P1 contingency”). The N-2 represents NERC Category P7 (“any two circuits of a multiple circuit tower line”) as well as WECC-S2 (for 500 kV only) (“any two circuits in the same right-of-way”) with no manual system adjustment between the two contingencies.

¹ Pub. Utilities Code § 345

1.5 Performance Criteria

As set forth on the Summary Table of Inputs and Methodology, this LCR Report is based on the most stringent mandatory standard (NERC, WECC or CAISO). The CAISO tests the electric system in regards to thermal overloads as well as dynamic and reactive margin compliance with the existing standards.

1.5.1 Performance Criteria

Category P0, P1 & P3 system performance requires that all thermal and voltage limits must be within their “Applicable Rating,” which, in this case, are the emergency ratings as generally determined by the PTO or facility owner. Applicable Rating includes a temporal element such that emergency ratings can only be maintained for certain duration. Under this category, load cannot be shed in order to assure the Applicable Ratings are met however there is no guarantee that facilities are returned to within normal ratings or to a state where it is safe to continue to operate the system in a reliable manner such that the next element out will not cause a violation of the Applicable Ratings.

The NERC Planning Standards require system operators to “look forward” to make sure they safely prepare for the “next” N-1 following the loss of the “first” N-1 (stay within Applicable Ratings after the “next” N-1). This is commonly referred to as N-1-1. Because it is assumed that some time exists between the “first” and “next” element losses, operating personnel may make any reasonable and feasible adjustments to the system to prepare for the loss of the second element, including, operating procedures, dispatching generation, moving load from one substation to another to reduce equipment loading, dispatching operating personnel to specific station locations to manually adjust load from the substation site, or installing a “Special Protection Scheme” that would remove pre-identified load from service upon the loss of the “next” element.² All Category P2, P4, P5, P6, P7 and extreme event requirements in this report refer to situations when in real time (N-0) or after the first contingency (N-1) the system requires additional readjustment in order to prepare for the next worst contingency. In this time frame, load drop is not allowed per existing planning criteria.

Generally, Category P2, P4, P5, P6, P7 and extreme event describes system performance that is expected following the loss of two or more system elements. This loss of two elements is generally expected to happen simultaneously, referred to as N-2. It should be noted that once the “next” element is lost after the first contingency, as discussed above under the Performance Criteria P1, the event is effectively a Category P6 or N-1-1 scenario. As noted above, depending on system design and expected system impacts, the **planned and controlled** interruption of

² A Special Protection Scheme is typically proposed as an operational solution that does not require additional generation and permits operators to effectively prepare for the next event as well as ensure security should the next event occur. However, these systems have their own risks, which limit the extent to which they could be deployed as a solution for grid reliability augmentation. While they provide the value of protecting against the next event without the need for pre-contingency load shedding, they add points of potential failure to the transmission network. This increases the potential for load interruptions because sometimes these systems will operate when not required and other times they will not operate when needed.

supply to customers (load shedding), the removal from service of certain generators and curtailment of exports may be utilized to maintain grid “security.”

1.5.2 CAISO Statutory Obligation Regarding Safe Operation

The ISO must maintain the system in a safe operating mode at all times. This obligation translates into respecting the Reliability Criteria at all times. For example, during normal operating conditions (8760 hours per year), the ISO must protect for all single contingencies (P1, P2) and multiple contingencies (P4, P5) as well as common mode double line outages (P7). As a further example, after a single contingency, the ISO must readjust the system in order to be able to support the loss of the next most stringent contingency (P3, P6 and P1+P7 resulting in potential voltage collapse or dynamic instability).

Figure 1.5-1 Temporal graph of LCR Category P0-P7

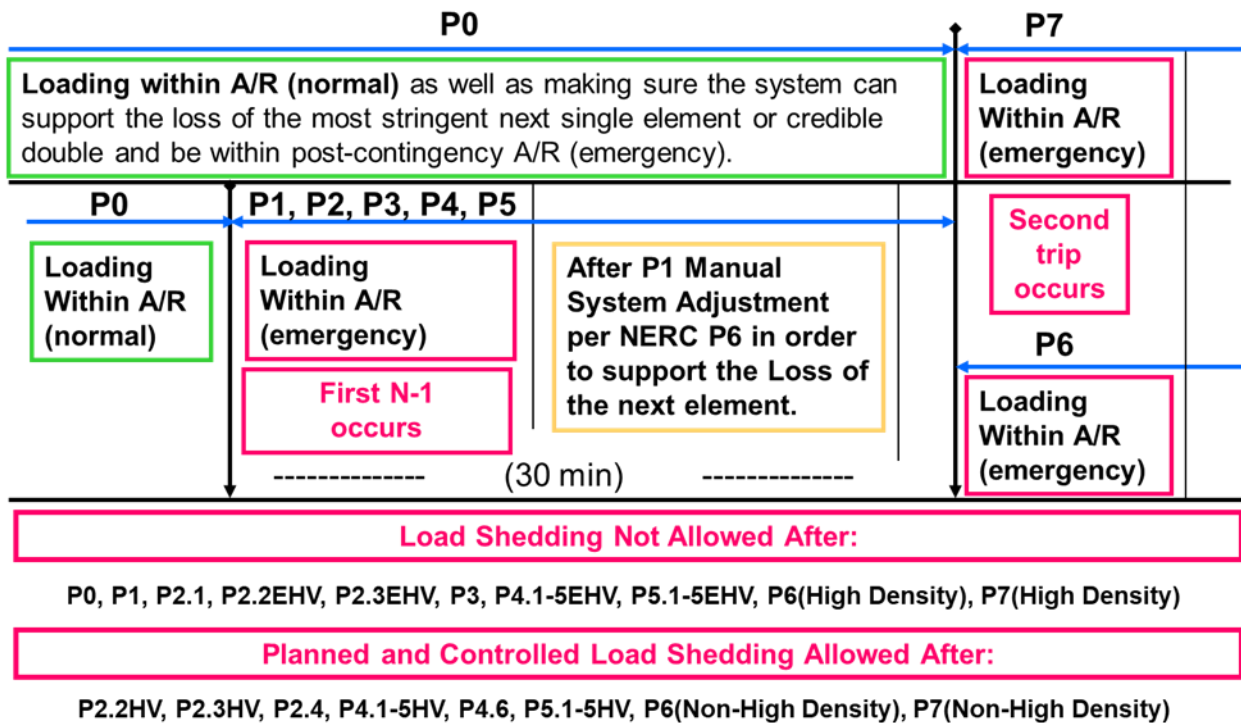

The following definitions guide the CAISO’s interpretation of the Reliability Criteria governing safe mode operation and are used in this LCT Study:

Applicable Rating:

This represents the equipment rating that will be used under certain contingency conditions.

Normal rating is to be used under normal conditions.

Long-term emergency ratings, if available, will be used in all emergency conditions as long as “system readjustment” is provided in the amount of time given (specific to each element) to reduce the flow to within the normal ratings. If not available, the normal rating is to be used.

Short-term emergency ratings, if available, can be used as long as “system readjustment” is provided in the “short-time” available in order to reduce the flow to within the long-term emergency ratings where the element can be kept for another length of time (specific to each element) before the flow needs to be reduced the below the normal ratings. If not available long-term emergency rating should be used.

Temperature-adjusted ratings shall not be used because this is a year-ahead study, not a real-time tool, and as such the worst-case scenario must be covered. In case temperature-adjusted ratings are the only ratings available then the minimum rating (highest temperature) given the study conditions shall be used.

CAISO Transmission Register is the only official keeper of all existing ratings mentioned above.

Ratings for future projects provided by PTO and agreed upon by the CAISO shall be used.

Other short-term ratings not included in the CAISO Transmission Register may be used as long as they are engineered, studied and enforced through clear operating procedures that can be followed by real-time operators.

Path Ratings need to be maintained within their limits in order to assure that proper capacity is available in order to operate the system in real-time in a safe operating zone.

Controlled load drop:

This is achieved with the use of a Special Protection Scheme.

Planned load drop:

This is achieved when the most limiting equipment has short-term emergency ratings AND the operators have an operating procedure that clearly describes the actions that need to be taken in order to shed load.

Special Protection Scheme:

All known SPS shall be assumed. New SPS must be verified and approved by the CAISO and must comply with the new SPS guideline described in the CAISO Planning Standards.

System Readjustment:

This represents the actions taken by operators in order to bring the system within a safe operating zone after any given contingency in the system.

Actions that can be taken as system readjustment after a Category P1, P2.1, P2.2(EHV), P2.3(EHV), P3, P4.1-5(EHV), P5.1-5(EHV), P6(high density area)&P7(high density area) contingency:

1. System configuration change – based on validated and approved operating procedures
2. Generation re-dispatch

- a. Decrease generation (up to 1150 MW) – limit given by single contingency SPS as part of the ISO Grid Planning standards (ISO SPS3)
- b. Increase generation – this generation will become part of the LCR need

Actions, which shall not be taken as system readjustment after a Category P1, P2.1, P2.2(EHV), P2.3(EHV), P3, P4.1-5(EHV), P5.1-5(EHV), P6(high density area)&P7(high density area) contingency:

1. Load drop – based on the intent of the ISO/WECC and NERC criteria for category P1 contingencies.

An objective of the planning process is to minimize the likelihood and magnitude of Non-Consequential Load Loss following Contingency events. NERC and ISO Planning standards mandate that no load shedding should be done immediately after a Category P1, P2.1, P2.2(EHV), P2.3(EHV), P3, P4.1-5(EHV), P5.1-5(EHV), P6(high density area)&P7(high density area) contingency. The system should be planned with no load shedding regardless of when it may occur (immediately or within 15-30 minutes after the first contingency). It follows that load shedding may not be utilized as part of the system readjustment period – in order to protect for the next most limiting contingency. Therefore, if there are available resources in the local area, such resources should be used during the manual adjustment period (and included in the LCR need) before resorting to shedding firm load.

Firm load shedding is allowed in a planned and controlled manner after the first contingency in P2.2(HV), P2.3(HV), P2.4, P4.1-5(HV), P4.6, P5.1-5(HV) and after the second contingency in P6(non-high density area), P7(non-high density area) & P1 system adjusted followed by P7 category events.

This interpretation tends to guarantee that firm load shedding is used to address Category P1, P2.1, P2.2(EHV), P2.3(EHV), P3, P4.1-5(EHV), P5.1-5(EHV), P6(high density area)&P7(high density area) conditions only under the limited circumstances where no other resource or validated operational measure is available. A contrary interpretation would constitute a departure from existing practice and degrade current service expectations by increasing load's exposure to service interruptions.

Time allowed for manual readjustment:

Tariff Section 40.3.1.1, requires the CAISO, in performing the Local Capacity Technical Study, to apply the following reliability criterion:

Time Allowed for Manual Adjustment: This is the amount of time required for the Operator to take all actions necessary to prepare the system for the next Contingency. The time should not be more than thirty (30) minutes.

The CAISO Planning Standards also impose this manual readjustment requirement. As a parameter of the Local Capacity Technical Study, the CAISO must assume that as the system operator the CAISO will have sufficient time to:

- (1) make an informed assessment of system conditions after a contingency has occurred;
- (2) identify available resources and make prudent decisions about the most effective system redispatch;
- (3) manually readjust the system within safe operating limits after a first contingency to be prepared for the next contingency; and
- (4) allow sufficient time for resources to ramp and respond according to the operator's redispatch instructions. This all must be accomplished within 30 minutes.

Local capacity resources can meet this requirement by either (1) responding with sufficient speed, allowing the operator the necessary time to assess and redispatch resources to effectively reposition the system within 30 minutes after the first contingency, or (2) have sufficient energy available for frequent dispatch on a pre-contingency basis to ensure the operator can meet minimum online commitment constraints or reposition the system within 30 minutes after the first contingency occurs. Accordingly, when evaluating resources that satisfy the requirements of the CAISO Local Capacity Technical Study, the CAISO assumes that local capacity resources need to be available in no longer than 20 minutes so the CAISO and demand response providers have a reasonable opportunity to perform their respective and necessary tasks and enable the CAISO to reposition the system within the 30 minutes in accordance with applicable reliability criteria.

2 Assumption Details: How the Study was Conducted

2.1 System Planning Criteria

The following table provides a comparison of system planning criteria, based on the NERC performance standards, used in the study:

Table 2.1-1: Criteria Comparison for Bulk Electric System contingencies

Contingency Component(s)	Mandatory Reliability Standards	Old Local Capacity Criteria	Local Capacity Criteria
<u>P0 – No Contingencies</u>	X	X	X
<u>P1 – Single Contingency</u>			
1. Generator (G-1)	X	X ¹	X ¹
2. Transmission Circuit (L-1)	X	X ¹	X ¹
3. Transformer (T-1)	X	X ^{1,2}	X ¹
4. Shunt Device	X		X ¹
5. Single Pole (dc) Line	X	X ¹	X ¹
<u>P2 – Single contingency</u>			
1. Opening a line section w/o a fault	X		X
2. Bus Section fault	X		X
3. Internal Breaker fault (non-Bus-tie Breaker)	X		X
4. Internal Breaker fault (Bus-tie Breaker)	X		X
<u>P3 – Multiple Contingency – G-1 + system adjustment and:</u>			
1. Generator (G-1)	X	X	X
2. Transmission Circuit (L-1)	X	X	X
3. Transformer (T-1)	X	X ²	X
4. Shunt Device	X		X
5. Single Pole (dc) Line	X	X	X
<u>P4 – Multiple Contingency - Fault plus stuck breaker</u>			
1. Generator (G-1)	X		X
2. Transmission Circuit (L-1)	X		X
3. Transformer (T-1)	X		X
4. Shunt Device	X		X
5. Bus section	X		X
6. Bus-tie breaker	X		X
<u>P5 – Multiple Contingency – Relay failure (delayed clearing)</u>			
1. Generator (G-1)	X		X
2. Transmission Circuit (L-1)	X		X
3. Transformer (T-1)	X		X
4. Shunt Device	X		X
5. Bus section	X		X

<u>P6 – Multiple Contingency – P1.2-P1.5 system adjustment and:</u>			
1. Transmission Circuit (L-1)	X	x	X
2. Transformer (T-1)	X	x	X
3. Shunt Device	X		X
4. Bus section	X		X
<u>P7 – Multiple Contingency - Fault plus stuck breaker</u>			
1. Two circuits on common structure (L-2)	X	X	X
2. Bipolar DC line	X	X	X
<u>Extreme event – loss of two or more elements</u>			
Two generators (Common Mode) G-2	X ⁴	X	X ⁴
Any P1.1-P1.3 & P1.5 system readjusted (Common Mode) L-2	X ⁴	X ³	X ⁵
All other extreme combinations.	X ⁴		X ⁴
¹ System must be able to readjust to a safe operating zone in order to be able to support the loss of the next contingency. ² A thermal or voltage criterion violation resulting from a transformer outage may not be cause for a local area reliability requirement if the violation is considered marginal (e.g. acceptable loss of facility life or low voltage), otherwise, such a violation will necessitate creation of a requirement. ³ Evaluate for risks and consequence, per NERC standards. No voltage collapse or dynamic instability allowed. ⁴ Evaluate for risks and consequence, per NERC standards. ⁵ Expanded to include any P1 system readjustment followed by any P7 without stuck breaker. For voltage collapse or dynamic instability situations mitigation is required “if there is a risk of cascading” beyond a relatively small predetermined area – less than 250 MW - directly affected by the outage.			

Table 2.1-2: Criteria Comparison for non-Bulk Electric System contingencies

Contingency Component(s)	Mandatory Reliability Standards	Old Local Capacity Criteria	Local Capacity Criteria
<u>P0 – No Contingencies</u>	X	X	X
<u>P1 – Single Contingency</u>			
1. Generator (G-1)	X	X ¹	X
2. Transmission Circuit (L-1)	X	X ¹	X
3. Transformer (T-1)	X	X ^{1,2}	X
4. Shunt Device	X		X
5. Single Pole (dc) Line	X	X ¹	X
<u>P2 – Single contingency</u>			
1. Opening a line section w/o a fault			
2. Bus Section fault			
3. Internal Breaker fault (non-Bus-tie Breaker)			
4. Internal Breaker fault (Bus-tie Breaker)			

<p><u>P3 – Multiple Contingency – G-1 + system adjustment and:</u> 1. Generator (G-1) 2. Transmission Circuit (L-1) 3. Transformer (T-1) 4. Shunt Device 5. Single Pole (dc) Line</p>	<p>X X X X X</p>	<p>X X X² X X</p>	<p>X X X X X</p>
<p><u>P4 – Multiple Contingency - Fault plus stuck breaker</u> 1. Generator (G-1) 2. Transmission Circuit (L-1) 3. Transformer (T-1) 4. Shunt Device 5. Bus section 6. Bus-tie breaker</p>			
<p><u>P5 – Multiple Contingency – Relay failure (delayed clearing)</u> 1. Generator (G-1) 2. Transmission Circuit (L-1) 3. Transformer (T-1) 4. Shunt Device 5. Bus section</p>			
<p><u>P6 – Multiple Contingency – P1.2-P1.5 system adjustment and:</u> 1. Transmission Circuit (L-1) 2. Transformer (T-1) 3. Shunt Device 4. Bus section</p>		<p>x x</p>	
<p><u>P7 – Multiple Contingency - Fault plus stuck breaker</u> 1. Two circuits on common structure (L-2) 2. Bipolar DC line</p>		<p>X X</p>	
<p><u>Extreme event – loss of two or more elements</u> Two generators (Common Mode) G-2 Any P1.1-P1.3 & P1.5 system readjusted (Common Mode) L-2 All other extreme combinations.</p>		<p>X X³</p>	
<p>¹ System must be able to readjust to a safe operating zone in order to be able to support the loss of the next contingency. ² A thermal or voltage criterion violation resulting from a transformer outage may not be cause for a local area reliability requirement if the violation is considered marginal (e.g. acceptable loss of facility life or low voltage), otherwise, such a violation will necessitate creation of a requirement ³ Evaluate for risks and consequence, per NERC standards. No voltage collapse or dynamic instability allowed.</p>			

A significant number of simulations were run to determine the most critical contingencies within each local area. Using power flow, post-transient load flow, and stability assessment tools, the system performance results of all tested contingencies were measured against the system performance requirements defined by the criteria shown in Tables 1 and 2. Where the specific system performance requirements were not met, generation was adjusted until performance

requirements were met for the local area. The adjusted generation constitutes the minimum generation needed in the local area. The following describes how the criteria were tested for the specific type of analysis performed.

2.1.1 Power Flow Assessment:

Table 2.1-3 Power flow criteria

Contingencies	Thermal Criteria ¹	Voltage Criteria ²
P0	Applicable Rating	Applicable Rating
P1 ³	Applicable Rating	Applicable Rating
P2	Applicable Rating	Applicable Rating
P3	Applicable Rating	Applicable Rating
P4	Applicable Rating	Applicable Rating
P5	Applicable Rating	Applicable Rating
P6 ⁴	Applicable Rating	Applicable Rating
P7	Applicable Rating	Applicable Rating
P1 + P7 ⁴	-	No Voltage Collapse

- 1 Applicable Rating – Based on CAISO Transmission Register or facility upgrade plans including established Path ratings.
- 2 Applicable Rating – CAISO Grid Planning Criteria or facility owner criteria as appropriate.
- 3 Following the first contingency (N-1), the generation must be sufficient to allow the operators to bring the system back to within acceptable operating range (voltage and loading) and/or appropriate OTC following the studied outage conditions and be able to safely prepare for the loss of the next most stringent element and be within Applicable Rating after the loss of the second element.
- 4 During normal operation or following the first contingency (N-1), the generation must be sufficient to allow the operators to prepare for the next worst N-1 or common mode N-2 without pre-contingency interruptible or firm load shedding. SPS/RAS/Safety Nets may be utilized to satisfy the criteria after the second N-1 or common mode N-2 except if the problem is of a thermal nature such that short-term ratings could be utilized to provide the operators time to shed either interruptible or firm load.

2.1.2 Post Transient Load Flow Assessment:

Table 2.1-4 Post transient load flow criteria

Contingencies	Reactive Margin Criteria ²
Selected ¹	Applicable Rating

- ¹ If power flow results indicate significant low voltages for a given power flow contingency, simulate that outage using the post transient load flow program. The post-transient assessment will develop appropriate Q/V and/or P/V curves.
- ² Applicable Rating – positive margin based on the higher of imports or load increase by 5% for N-1 contingencies, and 2.5% for N-2 contingencies.

2.1.3 Stability Assessment:

Table 2.1-5 Stability criteria

Contingencies	Stability Criteria ²
Selected ¹	Applicable Rating

- ¹ Base on historical information, engineering judgment and/or if power flow or post transient study results indicate significant low voltages or marginal reactive margin for a given contingency.
- ² Applicable Rating – CAISO Grid Planning Criteria or facility owner criteria as appropriate.

2.2 Load Forecast

2.2.1 System Forecast

The California Energy Commission (CEC) derives the load forecast at the system and Participating Transmission Owner (PTO) levels. This relevant CEC forecast is then distributed across the entire system, down to the local area, division and substation level. The PTOs use an econometric equation to forecast the system load. The predominant parameters affecting the system load are (1) number of households, (2) economic activity (gross metropolitan products, GMP), (3) temperature and (4) increased energy efficiency and distributed generation programs.

2.2.2 Base Case Load Development Method

The method used to develop the load in the base case is a melding process that extracts, adjusts and modifies the information from the system, distribution and municipal utility forecasts. The melding process consists of two parts: Part 1 deals with the PTO load and Part 2 deals with the

municipal utility load. There may be small differences between the methodologies used by each PTO to disaggregate the CEC load forecast to their level of local area as well as bar-bus model.

2.2.2.1 *PTO Loads in Base Case*

The methods used to determine the PTO loads are, for the most part, similar. One part of the method deals with the determination of the division³ loads that would meet the requirements of 1-in-5 or 1-in-10 system or area base cases and the other part deals with the allocation of the division load to the transmission buses.

a. Determination of division loads

The annual division load is determined by summing the previous year division load and the current division load growth. Thus, the key steps are the determination of the initial year division load and the annual load growth. The initial year for the base case development method is based heavily on recorded data. The division load growth in the system base case is determined in two steps. First, the total PTO load growth for the year is determined, as the product of the PTO load and the load growth rate from the system load forecast. Then this total PTO load growth is allocated to the division, based on the relative magnitude of the load growth projected for the divisions by the distribution planners. For example, for the 1-in-10 area base case, the division load growth determined for the system base case is adjusted to the 1-in-10 temperature using the load temperature relation determined from the latest peak load and temperature data of the division.

b. Allocation of division load to transmission bus level

Since the loads in the base case are modeled at the various transmission buses, the division loads developed must be allocated to those buses. The allocation process is different depending on the load types. For the most part, each PTO classifies its loads into four types: conforming, non-conforming, self-generation and generation-plant loads. Since the non-conforming and self-generation loads are assumed to not vary with temperature, their magnitude would be the same in the system or area base cases of the same year. The remaining load (the total division load developed above, less the quantity of non-conforming and self-generation load) is the conforming load. The remaining load is allocated to the transmission buses based on the relative magnitude of the distribution forecast. The summation of all base case loads is generally higher than the load forecast because some load, i.e., self-generation and generation-plant, are behind the meter and must be modeled in the base cases. However, for the most part, metered or aggregated data with telemetry is used to come up with the load forecast.

2.2.2.2 *Municipal Loads in Base Case*

The municipal utility forecasts that have been provided to the CEC and PTOs for the purposes of their base cases were also used for this study.

³ Each PTO divides its territory in a number of smaller area named divisions. These are usually smaller and compact areas that have the same temperature profile.

2.3 Power Flow Program Used in the LCR analysis

The technical studies were conducted using General Electric's Power System Load Flow (GE PSLF) program version 22.0.4.1 and PowerGem's Transmission Adequacy and Reliability Assessment (TARA) program version 2302.1. This GE PSLF program is available directly from GE or through the Western System Electricity Council (WECC) to any member and TARA program is commercially available.

To evaluate Local Capacity Areas, the starting base case was adjusted to reflect the latest generation and transmission projects as well as the one-in-ten-year peak load forecast for each Local Capacity Area as provided to the CAISO by the PTOs.

Electronic contingency files provided by the PTOs were utilized to perform the numerous contingencies required to identify the LCR. These contingency files include remedial action and special protection schemes that are expected to be in operation during the year of study. A CAISO created EPCL (a GE programming language contained within the GE PSLF package) routine and/or TARA software were used to run the combination of contingencies; however, other routines are available from WECC with the GE PSLF package or can be developed by third parties to identify the most limiting combination of contingencies requiring the highest amount of generation within the local area to maintain power flows within applicable ratings.

2.4 Estimate of Battery Storage Needs due to Charging Constraints

Local areas and sub-areas have limited transmission capability and therefore rely on internal resources to be available in order to reliably serve internal load. Battery storage will help serve local load during the discharge cycle, however it will also increase local load during the charging cycle.

Due to recent procurement activities geared toward the acquisition of this type of technology, the CAISO is herein estimating the characteristics (MW, MWh, discharge duration) required from battery storage technology in order to seamlessly integrate in each local area and sub-area.

The CAISO expects that for batteries that displace other local resource adequacy resources, the transmission capability under the most limiting contingency and the other local capacity resources must be sufficient to recharge the batteries in anticipation of the outage continuing through the night and into the next day's peak load period.

For each local area and sub-area, the CAISO has estimated the battery storage characteristics, given their unique load shape, constraints and requirements as well as the energy characteristics of other resources required to meet standards. Due to this fact, the strict addition of the sub-area battery storage characteristics (MW, MWh and duration) may not closely align with the overall local area battery storage characteristic requirements (MW, MWh and duration).

Assumptions

- 1) Total load serving capability includes capability from transmission system and local generation needed for LCR under the worst contingency.

- 2) Storage added replaces existing generation MW for MW. First the batteries will replace as much as possible of existing gas resources, Second if the area and/or sub-area has run out of gas resources to displace then other technologies may be reduced in order to determine the maximum battery charging limit.
- 3) Effectiveness factors are assumed not to be a factor. Battery storage is assumed to be installed at the same sites where resources are displaced or assumed to have the same effectiveness factors.
- 4) Deliverability of incremental storage capacity is not evaluated. It is assumed battery storage will take over deliverability from old resources through repower. Any new battery storage resource needs to go through the generation interconnection process in order to receive deliverability and it is not evaluated in this study. CAISO cannot guaranty that there is enough deliverability available for new resources. New transmission upgrades may be required in order to make such new resources deliverable to the aggregate of load.
- 5) Includes battery storage charging/discharging efficiency of 85%.
- 6) Daily charging required is distributed to all non-discharging hours proportionally using delta between net load and the total load serving capability.
- 7) Energy required for charging, beyond the transmission capability under contingency condition, is produced by other LCR required resources within the local area and sub-area that are available for production during off-peak hours.
- 8) Hydro resources are considered to be available for production during off-peak hours, however these resources are energy limited themselves and based on past availability data they can have severely limited output during off-peak hours especially during late summer peaks under either normal or dry hydro years.
- 9) The study assumes the ability to provide perfect dispatch and the ability to enforce charging requirements for multiple contingency conditions (like N-1-1) in the day ahead time frame while the system is under normal (no contingency) conditions. CAISO software improvements and/or augmentations are required in order to achieve this goal.

Installing battery storage with insufficient characteristics (MW, MWh and duration) will not result in a one for one reduction of the local area or sub-area need for other types of resources. The CAISO expects that the overall RA portfolio provided by all LSEs to account for the uplift, beyond the minimum LCR need, in MWs required from other type of resources for all areas and sub-areas where LSEs have procured battery storage beyond the charging capability or with incorrect characteristics (MW, MWh and duration). If uplift is not provided the CAISO may use its back stop authority to assure that reliability standards are met throughout the day, including off-peak hours.

3 Locational Capacity Requirement Study Results

3.1 Summary of Study Results

LCR is defined as the amount of resource capacity that is needed within a Local Capacity Area to reliably serve the load located within this area. The results of the CAISO's analysis are summarized in the Executive Summary Tables.

Table 3.1-1 2029 Local Capacity Needs vs. Peak Load and Local Area Resources

	2029 Total LCR (MW)	Peak Load (1 in10) (MW)	2029 LCR as % of Peak Load	Total NQC Local Area Resources (MW)	2029 LCR as % of Total NQC
Humboldt	173	223	78%	175	99%
North Coast/North Bay	650	1517	43%	985	66%
Sierra	1885	1978	95%	1925	98%
Stockton	763	923	83%	763	100%
Greater Bay	6259	12333	51%	8389	75%
Greater Fresno	2512	3773	67%	3267	77%
Kern	241	902	27%	434	56%
Big Creek/Ventura	1329	5184	26%	4350	31%
LA Basin	5076	19596	26%	10296	49%
San Diego/Imperial Valley	3121	5046	62%	5809	54%
Total*	22009	51475	43%	36393	60%

Table 3.1-2 2028 Local Capacity Needs vs. Peak Load and Local Area Resources

	2028 Total LCR (MW)	Peak Load (1 in10) (MW)	2028 LCR as % of Peak Load	Total Dependable Local Area Resources (MW)	2028 LCR as % of Total Area Resources
Humboldt	148	182	81%	176	84%
North Coast/North Bay	891	1572	57%	989	90%
Sierra	1415	1843	77%	1883	75%
Stockton	772	949	81%	772	100%
Greater Bay	6261	11757	53%	7948	79%
Greater Fresno	2728	3637	75%	3127	87%
Kern	427	966	44%	427	100%
LA Basin	1216	4720	26%	4117	30%
Big Creek/Ventura	5940	20350	29%	8353	71%
San Diego/Imperial Valley	3575	5221	68%	5388	66%
Total*	23373	51197	46%	33180	70%

* Value shown only illustrative, since each local area peaks at a different time.

Table 3.1-1 and Table 3.1-2 shows how much of the Local Capacity Area load is dependent on local resources and how many local resources must be available in order to serve the load in those Local Capacity Areas in a manner consistent with the Reliability Criteria. These tables also indicate where new transmission projects, new resource additions or demand side management programs would be most useful in order to reduce the dependency on existing, generally older and less efficient local area resources.

The term “Qualifying Capacity” used in this report is the “Net Qualifying Capacity” (“NQC”) posted on the CAISO web site at:

<http://www.caiso.com/planning/Pages/ReliabilityRequirements/Default.aspx>

The NQC list includes the area (if applicable) where each resource is located for units already operational. Neither the NQC list nor this report incorporates Demand Side Management programs and their related NQC. Units scheduled to become operational before June 1 of 2029 have been included in this 2029 Long-Term LCT Study Report and added to the total NQC values for those respective areas (see detail write-up for each area).

Regarding the main tables up front (page 2), the first column, “August Qualifying Capacity,” reflects three sets of resources. The first set is comprised of resources that would normally be expected to be on-line such as Municipal and Regulatory Must-take resources (state, federal, municipal and QFs). The second set is “market” based resources (market, net seller, wind and battery). The third set are solar resources, since they may or may not be available during the actual peak hour for the respective local area. The second column, “Capacity at Peak” identifies how much of the August Qualifying Capacity is expected to be available during the peak time for each particular local area. The third column, “YEAR LCR Need”, sets forth the local capacity requirements, without the deficiencies that must be addressed, necessary to attain a service reliability level required to comply with NERC/WECC/CAISO mandatory reliability standards. Table 3.1-3 includes estimated characteristics (MW, MWh, discharge duration) required from battery storage technology in order to seamlessly integrate in each local area and sub-area. The CAISO expects that for batteries that displace other local resource adequacy resources, the transmission capability under the most limiting contingency and the other local capacity resources must be sufficient to recharge the batteries in anticipation of the outage continuing through the night and into the next day’s peak load period.

Table 3.1-3 2029 Battery Storage Characteristics Limited by Charging Capability

Area/Sub-area	Pmax MW	Energy MWh	Max. # of discharge hours	1 for 1 MW Replacement with 4-hour battery	Replacing mostly	Comment
Humboldt	40	161	8	40	gas	
North Coast/North Bay Overall	470	3574	12	90	geothermal	
Eagle Rock	149	507	9	26	geothermal	
Fulton	320	1860	9	150	geothermal	
Sierra	-	-	-	-	-	Flow through
Placer	30	136	10	28	hydro	

Area/Sub-area	Pmax MW	Energy MWh	Max. # of discharge hours	1 for 1 MW Replacement with 4-hour battery	Replacing mostly	Comment
Pease	-	-	-	-	-	Eliminated
Gold Hill-Drum	-	-	-	-	-	Eliminated
Stockton	-	-	-	-	-	Sum of sub-areas
Lockeford	-	-	-	-	gas	Eliminated
Tesla-Bellota	265	1300	10	215	gas	
Greater Bay Overall	1577	6300	9	1375	gas	
Llagas	100	385	10	24	gas	
San Jose	180	622	9	155	gas	
South Bay-Moss Landing	1146	4577	12	1144	gas	
Oakland	51	204	11	51	distillate	N/A
Greater Fresno Overall	1315	6855	10	980	hydro	
Panoche	119	955	12	55	gas	
Herndon	500	2629	10	350	hydro	
Borden	-	-	-	-	hydro	Eliminated
Hanford	36	180	15	24	gas	
Coalinga	39	263	12	11	solar	
Reedley	50	344	9	11	hydro	
Kern Overall	-	-	-	-	-	N/A
Westpark	33	91	6	12	gas	
Kern Power-Tevis	-	-	-	-	solar	N/A
Kern Oil	100	312	8	21	gas	
South Kern PP	241	1062	8	175	gas	
Big Creek/Ventura Overall	612	4042	12	264	gas	
Vestal	262	1206	12	238	hydro	
Santa Clara	231	1205	11	166	gas	
LA Basin Overall	3596	22903	12	1106	gas	
Eastern	1759	11245	11	452	gas	
Western	1837	11658	12	654	gas	
El Nido	195	1469	11	45	gas	
San Diego/Imperial Valley Overall	1205	6728	11	789	gas	
San Diego	1205	6728	11	789	gas	
El Cajon	-	-	-	-	gas	Eliminated
Border	32	175	8	17	gas	

3.2 Summary of Results by Local Area

Each Local Capacity Area’s overall requirement is determined by also achieving each sub-area requirement. Because these areas are a part of the interconnected electric system, the total for each Local Capacity Area is not simply a summation of the sub-area needs. For example, some sub-areas may overlap and therefore the same units may count for meeting the needs in both sub-areas.

3.2.1 Humboldt Area

3.2.1.1 Area Definition

The transmission tie lines into the area include:

- Bridgeville-Cottonwood 115 kV line #1
- Humboldt-Trinity 115 kV line #1
- Laytonville-Garberville 60 kV line #1
- Trinity-Maple Creek 60 kV line #1

The substations that delineate the Humboldt Area are:

- Bridgeville is in, Low Gap, Wildwood and Cottonwood are out
- Humboldt is in, Trinity is out
- Kekawaka and Garberville are in, Laytonville is out
- Maple Creek is in, Trinity and Ridge Cabin are out

3.2.1.1.1 Humboldt LCR Area Diagram

Figure 3.2-1 Humboldt LCR Area

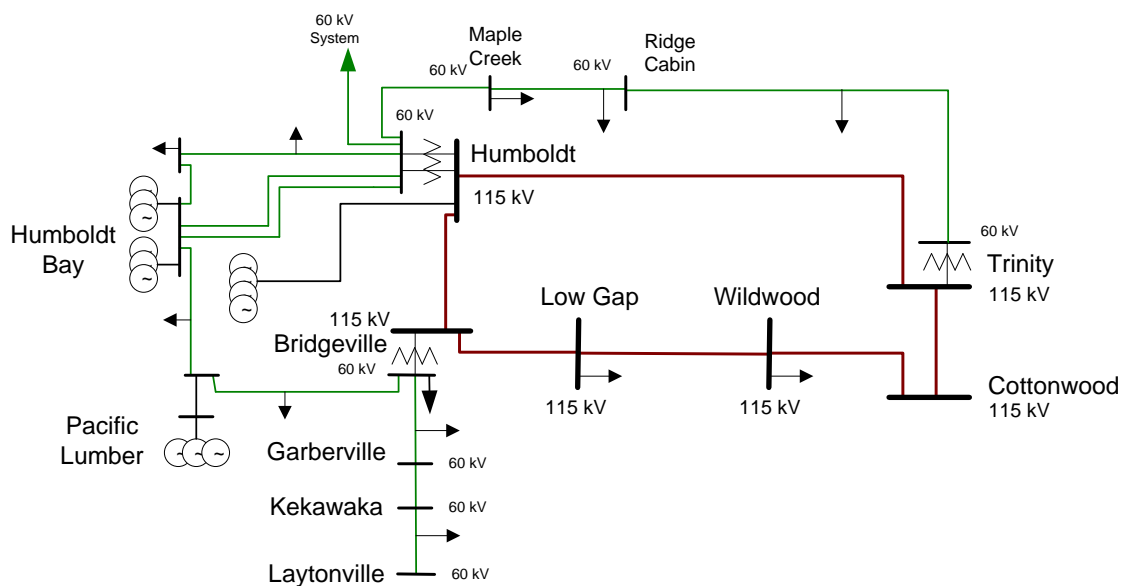

3.2.1.1.2 Humboldt LCR Area Load and Resources

Table 3.2-1 provides the forecasted load and resources. The list of generators within the LCR area are provided in Attachment A.

In year 2029 the estimated time of local area peak is 19:00 PM.

This area does not contain models of solar resources capable of providing resource adequacy.

If required, all non-solar technology type resources are dispatched at NQC.

Table 3.2-1 Humboldt LCR Area 2029 Forecast Load and Resources

Load (MW)		Generation (MW)	Aug NQC	At Peak
Gross Load	214	Market/Net Seller	175	175
AAEE	-2	Battery	0	0
Behind the meter DG	0	MUNI/QF	0	0
Net Load	212	Solar	0	0
Transmission Losses	11	Existing 20-minute Demand Response	0	0
Pumps	0	Mothballed	0	0
Load + Losses + Pumps	223	Total	175	175

3.2.1.1.3 Humboldt LCR Area Hourly Profiles

Figure 3.2-2 illustrates the forecast 2029 profile for the summer peak, winter peak and spring off-peak days for the Humboldt LCR area with the Category P6 transmission capability without resources. Figure 3.2-3 illustrates the forecast 2029 hourly profile for Humboldt LCR area with the Category P6 transmission capability without resources.

Figure 3.2-2 Humboldt 2029 Peak Day Forecast Profiles

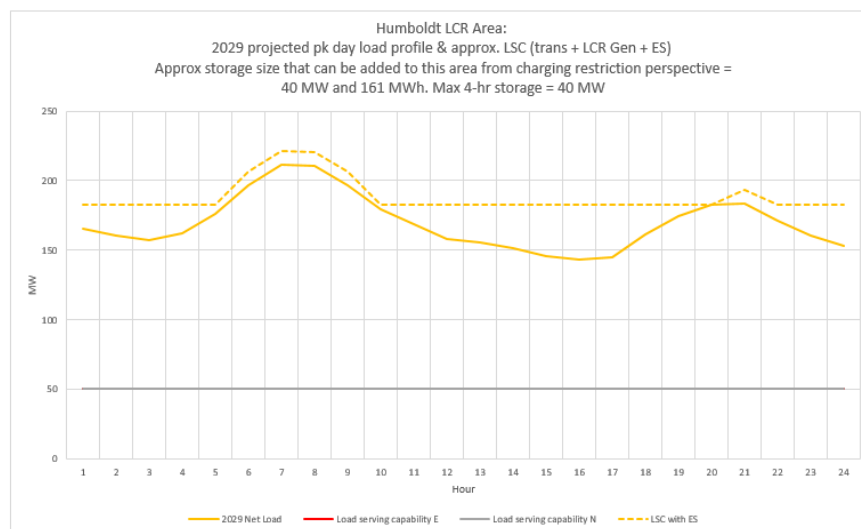
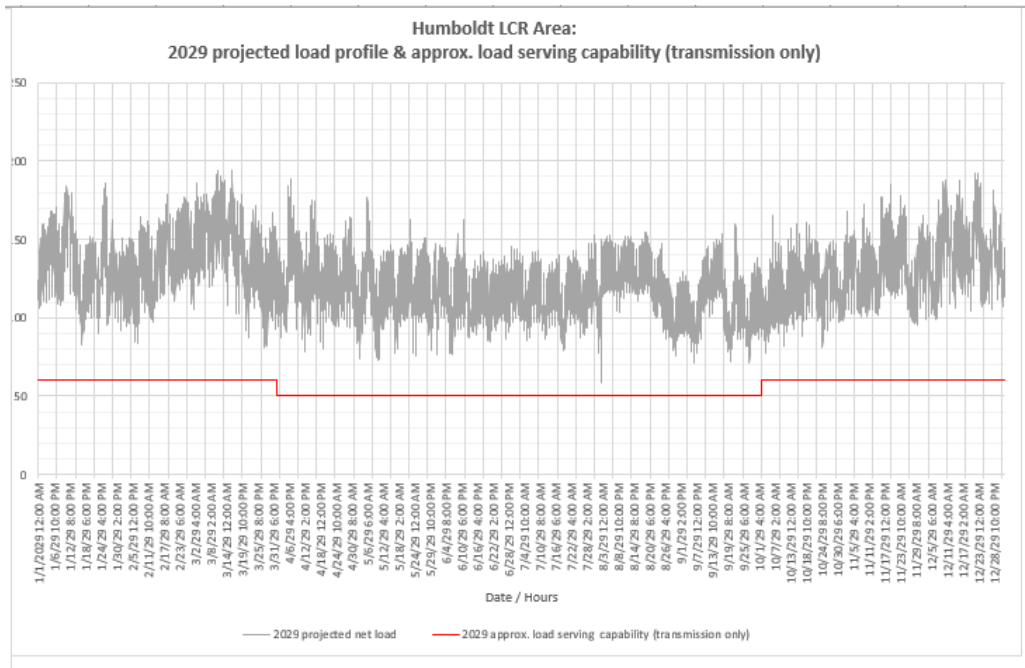

Figure 3.2-3 Humboldt 2029 Forecast Hourly Profile



3.2.1.1.4 Approved transmission projects included in base cases

Maple Creek Reactive Support (rescoped to Willow Creek 60 kV substation)

3.2.1.2 Humboldt Overall LCR Requirement

Table 3.2-2 identifies the area LCR requirements. The LCR requirement for Category P6 contingency is 173 MW.

Table 3.2-2 Humboldt LCR Area Requirements

Year	Limit	Category	Limiting Facility	Contingency	LCR (MW) (Deficiency)
2029	First Limit	P6	Humboldt-Trinity 115 kV	Cottonwood-Bridgeville 115 kV & Humboldt - Humboldt Bay 115 kV	173

3.2.1.2.1 Effectiveness factors

For most helpful procurement information please read procedure 2210Z Effectiveness Factors under 7110 posted at: <http://www.caiso.com/Documents/2210Z.pdf>

3.2.1.2.2 Changes compared to last year's results

Compared with 2028 the load forecast is higher by 41 MW and the LCR has increased by 25 MW.

3.2.2 North Coast / North Bay Area

3.2.2.1 Area Definition

The transmission tie facilities coming into the North Coast/North Bay area are:

- Cortina-Mendocino 115 kV Line
- Cortina-Eagle Rock 115 kV Line
- Willits-Garberville 60 kV line #1
- Vaca Dixon-Lakeville 230 kV line #1
- Tulucaj-Vaca Dixon 230 kV line #1
- Lakeville-Sobrante 230 kV line #1
- Ignacio-Sobrante 230 kV line #1

The substations that delineate the North Coast/North Bay area are:

- Cortina is out, Mendocino and Indian Valley are in
- Cortina is out, Eagle Rock, Highlands and Homestake are in
- Willits and Lytonville are in, Kekawaka and Garberville are out
- Vaca Dixon is out, Lakeville is in
- Tulucaj is in, Vaca Dixon is out
- Lakeville is in, Sobrante is out
- Ignacio is in, Sobrante and Crocket are out

3.2.2.1.1 North Coast and North Bay LCR Area Diagram

Figure 3.2-4 North Coast and North Bay LCR Area

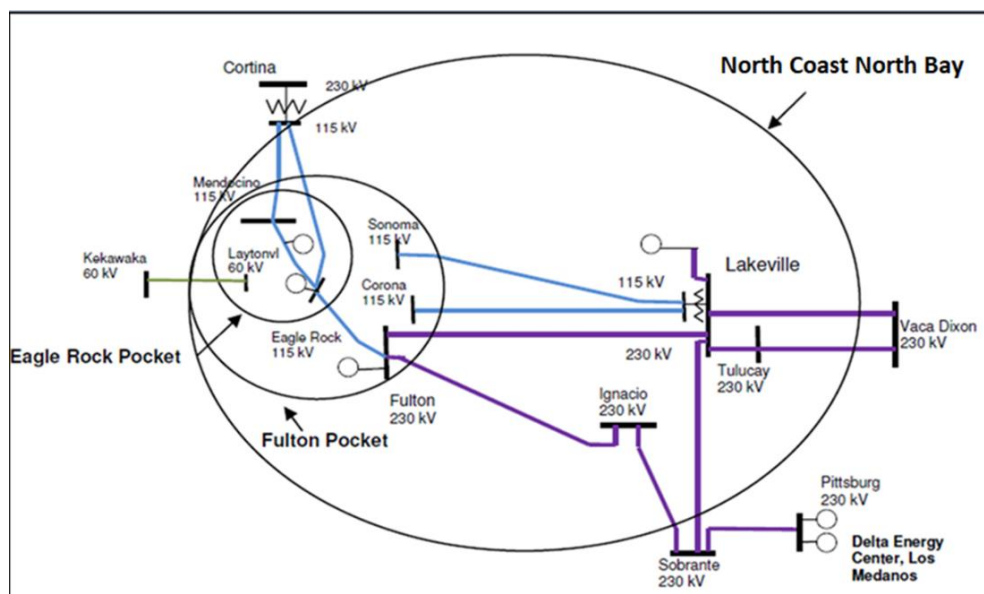

3.2.2.1.2 North Coast and North Bay LCR Area Load and Resources

Table 3.2-3 provides the forecasted load and resources. The list of generators within the LCR area are provided in Attachment A.

In year 2029 the estimated time of local area peak is 18:20 PM.

This area does not contain models of solar resources capable of providing resource adequacy.

If required, all non-solar technology type resources are dispatched at NQC.

Table 3.2-3 North Coast and North Bay LCR Area 2029 Forecast Load and Resources

Load (MW)		Generation (MW)	Aug NQC	At Peak
Gross Load	1567	Market/Net Seller	837	837
AAEE	-24	Battery	0	0
Behind the meter DG	-59	MUNI/QF	136	136
Net Load	1484	Solar	0	0
Transmission Losses	33	Existing 20-minute Demand Response	12	12
Pumps	0	Mothballed	0	0
Load + Losses + Pumps	1517	Total	985	985

3.2.2.1.3 North Coast and North Bay LCR Area Hourly Profiles

The hourly profiles for the North Coast North Bay LCR area is not provided there is no binding LCR for this area in 2029.

3.2.2.1.4 Approved transmission projects modeled in base cases

- Lakeville 60 kV Area Reinforcement
- Clear Lake 60 kV System Reinforcement
- Vaca Dixon-Lakeville 230 kV Corridor Series Compensation
- Tulucay-Napa #2 60 kV Line Capacity Increase
- Santa Rosa 115 kV lines Reconductoring project
- New Collinsville 500 kV Substation

3.2.2.2 Eagle Rock LCR Sub-area

Eagle Rock is a sub-area of the North Coast and North Bay LCR Area.

3.2.2.2.1 Eagle Rock LCR Sub-area Diagram

Figure 3.2-5 Eagle Rock LCR Sub-area

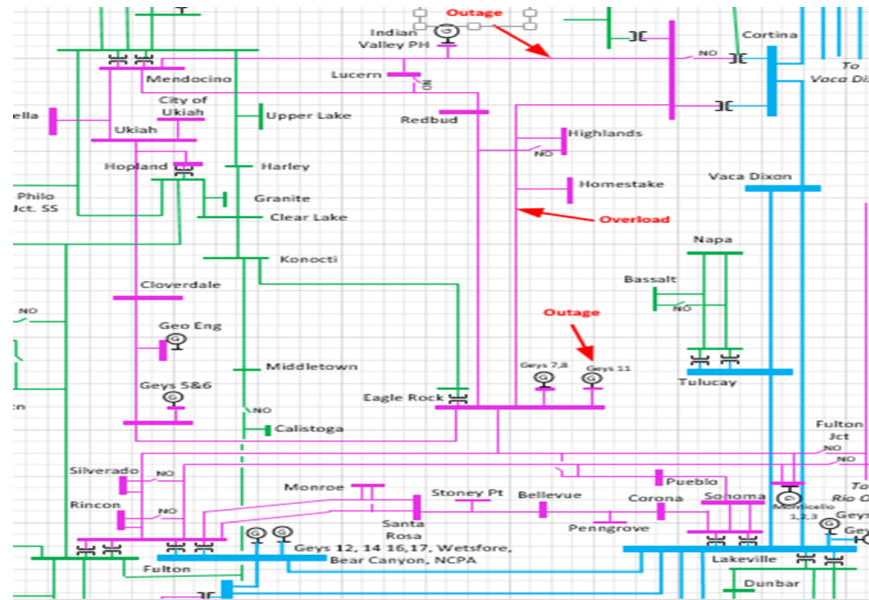

3.2.2.2.2 Eagle Rock LCR sub-area Load and Resources

Table 3.2-4 provides the forecasted load and resources. The list of generators within the LCR sub-area are provided in Attachment A.

Table 3.2-4 Eagle Rock LCR Area 2029 Forecast Load and Resources

Load (MW)		Generation (MW)	Aug NQC	At Peak
Gross Load	246	Market/Net Seller	271	271
AEE	-4	Battery	0	0
Behind the meter DG	-9	MUNI/QF	2	2
Net Load	233	Solar	0	0
Transmission Losses	13	Existing 20-minute Demand Response	0	0
Pumps	0	Mothballed	0	0
Load + Losses + Pumps	246	Total	273	273

3.2.2.2.3 Eagle Rock LCR Sub-area Hourly Profiles

Figure 3.2-6 illustrates the forecast 2029 profile for the peak day for the Eagle Rock LCR sub-area with the Category P3 normal and emergency load serving capabilities without local resources. The chart also includes an estimated amount of energy storage that can be added to this local area from charging restriction perspective. Figure 3.2-7 illustrates the forecast 2029 hourly profile for Eagle Rock LCR sub-area with the Category P3 emergency load serving capability without local resources.

Figure 3.2-6 Eagle Rock LCR Sub-area 2029 Peak Day Forecast Profiles

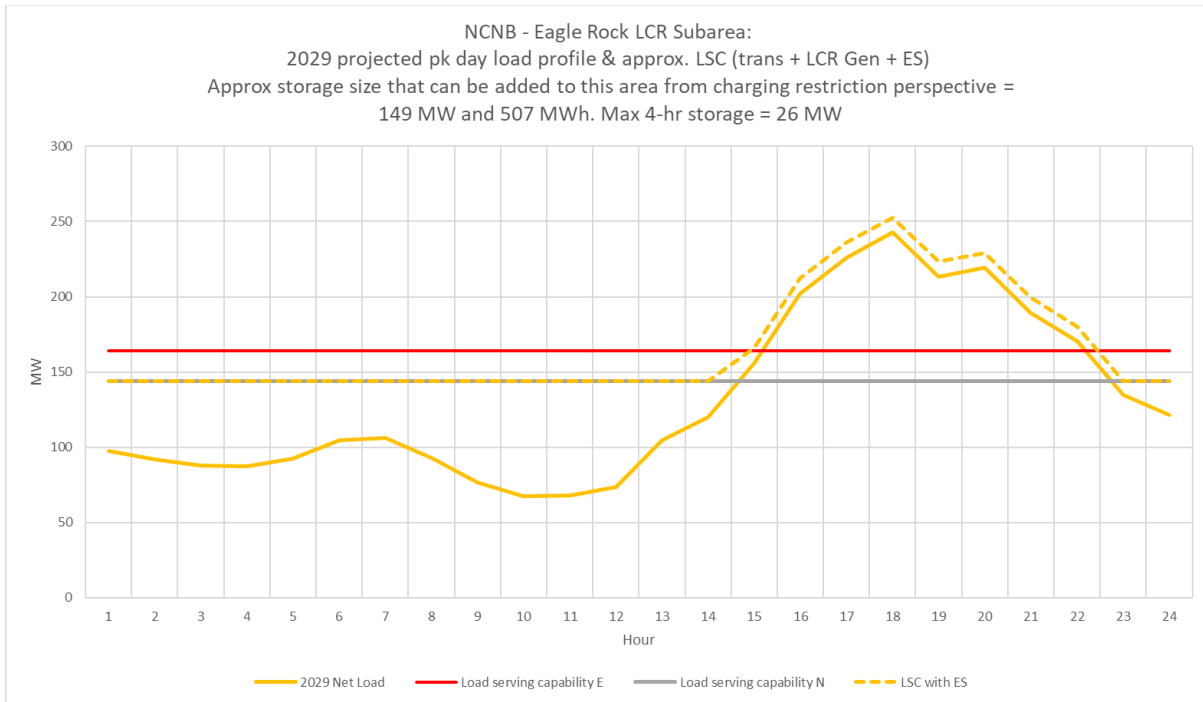
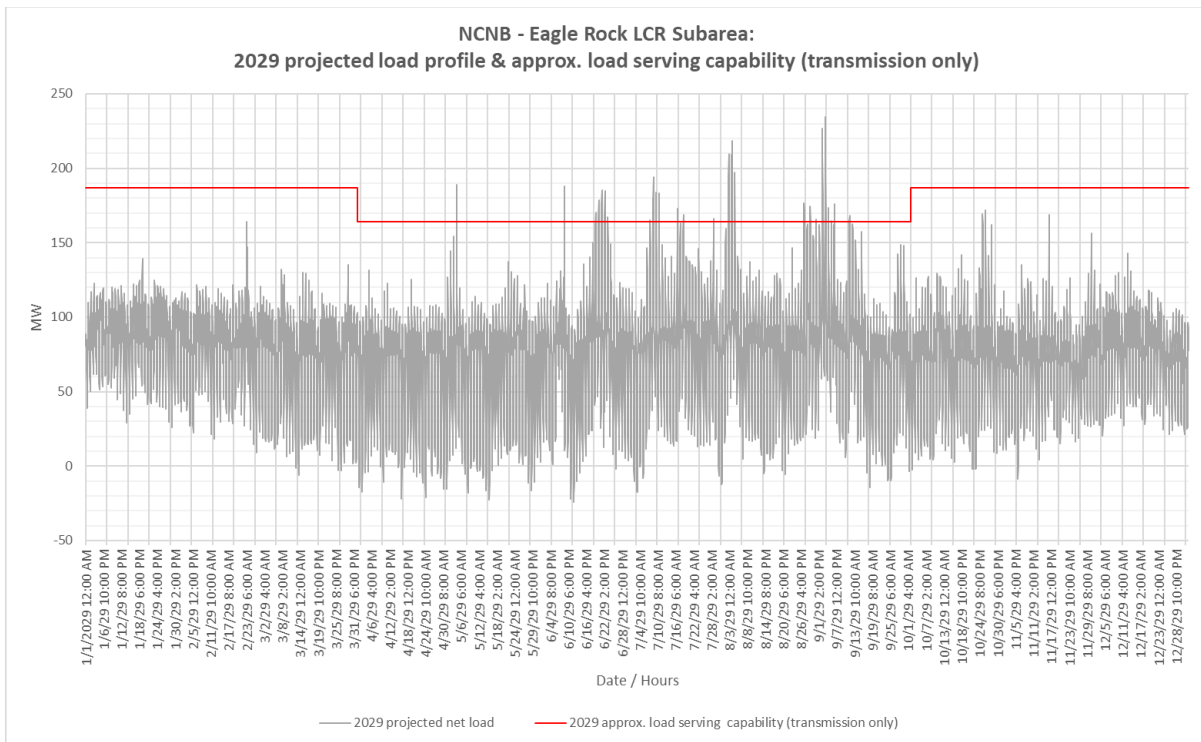

Figure 3.2-7 Eagle Rock LCR Sub-area 2029 Forecast Hourly Profiles



3.2.2.2.4 Eagle Rock LCR Sub-area Requirement

Table 3.2-5 identifies the sub-area LCR requirements. The LCR requirement for Category P3 contingency is 149 MW.

Table 3.2-5 Eagle Rock LCR Sub-area Requirements

Year	Limit	Category	Limiting Facility	Contingency	LCR (MW) (Deficiency)
2029	First Limit	P3	Thermal overload of Eagle Rock-Cortina 115 kV line	Cortina-Mendocino 115 kV with Geyser #11 unit out	149

3.2.2.2.5 Effectiveness factors

Effectiveness factors for generators in the Eagle Rock LCR sub-area are in Attachment B table titled [Eagle Rock](#).

For most helpful procurement information please read procedure 2210Z Effectiveness Factors under 7120 posted at: <http://www.caiso.com/Documents/2210Z.pdf>

3.2.2.3 Fulton Sub-area

Fulton is a sub-area of the North Coast and North Bay LCR Area.

3.2.2.3.1 Fulton LCR Sub-area Diagram

Figure 3.2-8 Fulton LCR Sub-area

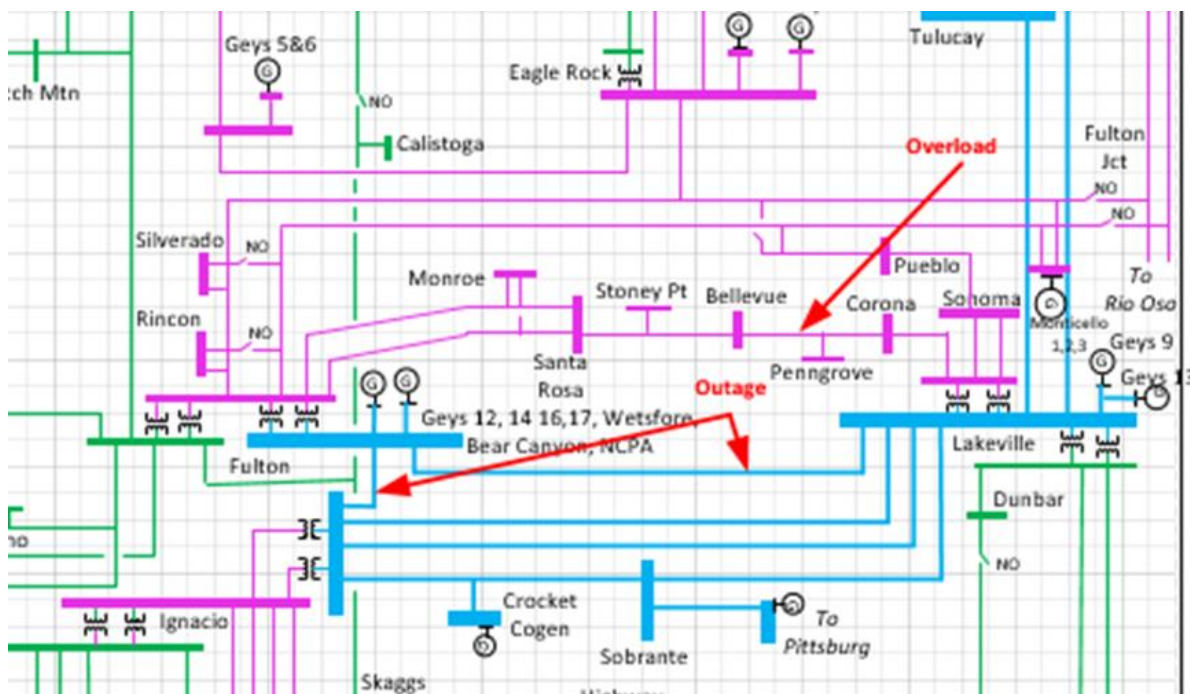

3.2.2.3.2 Fulton LCR Sub-area Load and Resources

Table 3.2-6 provides the forecasted load and resources. The list of generators within the LCR sub-area are provided in Attachment A.

Table 3.2-6 Fulton LCR Area 2029 Forecast Load and Resources

Load (MW)		Generation (MW)	Aug NQC	At Peak
Gross Load	915	Market/Net Seller	537	537
AAEE	-13	Battery	0	0
Behind the meter DG	-34	MUNI/QF	57	57
Net Load	868	Solar	0	0
Transmission Losses	19	Existing 20-minute Demand Response	0	0
Pumps	0	Mothballed	0	0
Load + Losses + Pumps	887	Total	594	594

3.2.2.3.3 Fulton LCR Sub-area Hourly Profiles

Figure 3.2-9 illustrates the forecast 2029 profile for the peak day for the Fulton LCR sub-area with the Category P6 normal and emergency load serving capabilities without local resources. The chart also includes an estimated amount of energy storage that can be added to this local area from charging restriction perspective. Figure 3.2-10 illustrates the forecast 2029 hourly profile for Fulton LCR sub-area with the Category P6 emergency load serving capability without local resources.

Figure 3.2-9 Fulton LCR Sub-area 2029 Peak Day Forecast Profiles

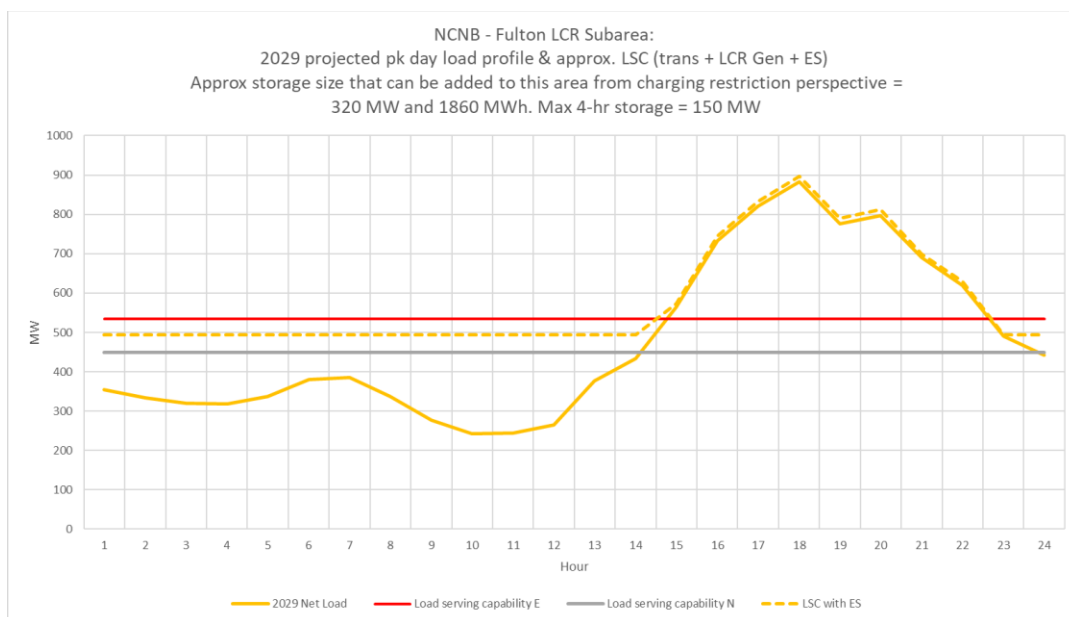
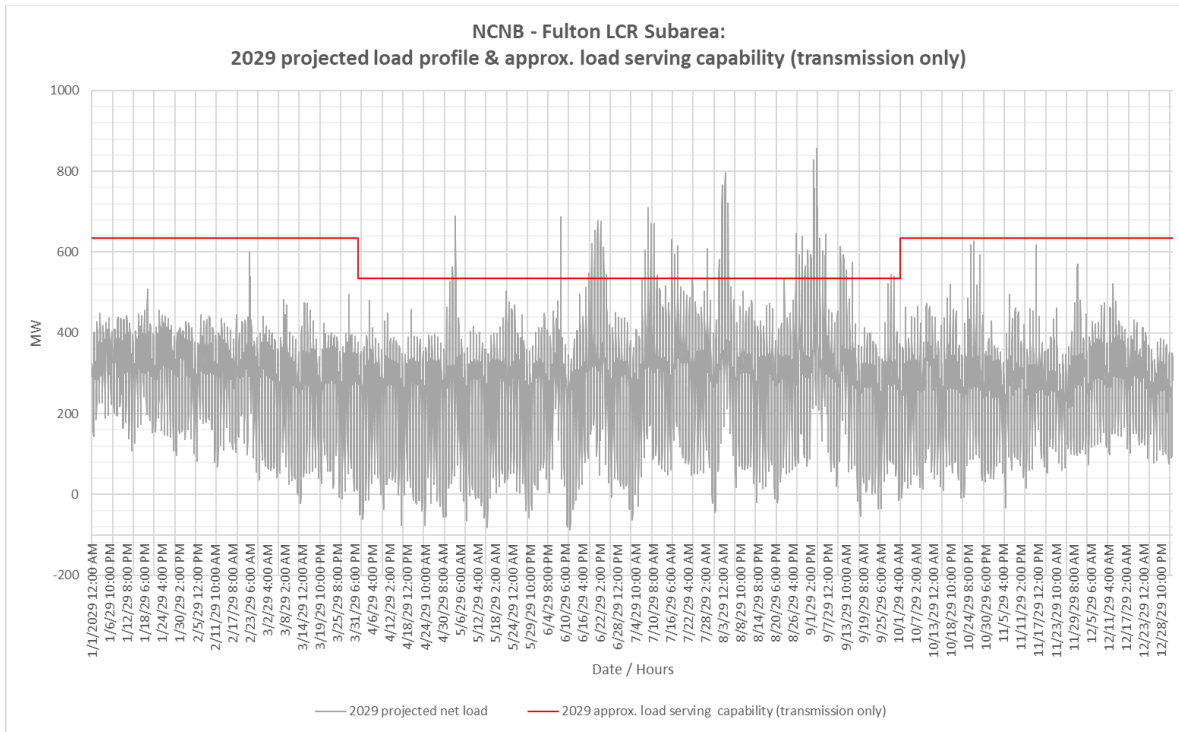

Figure 3.2-10 Fulton LCR Sub-area 2029 Forecast Hourly Profiles



3.2.2.3.4 Fulton LCR Sub-area Requirement

Table 3.2-7 identifies the sub-area LCR requirements. The LCR requirement for Category P6 contingency is 383 MW.

Table 3.2-7 Fulton LCR Sub-area Requirements

Year	Limit	Category	Limiting Facility	Contingency	LCR (MW) (Deficiency)
2029	First Limit	P6	Thermal overload on Eagle Rock-Cortina 115 kV Line	Fulton-Lakeville #1 230 kV & Fulton-Ignacio #1 230 kV	383

3.2.2.3.5 Effectiveness factors

For most helpful procurement information please read procedure 2210Z Effectiveness Factors under 7120 posted at: <http://www.caiso.com/Documents/2210Z.pdf>

3.2.2.4 North Coast and North Bay Overall

Table 3.2-3 provides the forecasted load and resources. The list of generators within the LCR sub-area are provided in Attachment A.

3.2.2.4.2 North Coast and North Bay Overall Requirement

Table 3.2-8 identifies the sub-area LCR requirements. The LCR requirement for Category P6 contingency is 650 MW.

Table 3.2-8 North Coast and North Bay LCR area Requirements

Year	Limit	Category	Limiting Facility	Contingency	LCR (MW) (Deficiency)
2029	First Limit	P6	Thermal overload on Eagle Rock-Cortina 115 kV line	Vaca Dixon-Tulucay 230 kV and Cortina-Mendocino 115 kV lines	650

3.2.2.4.3 Effectiveness factors

For most helpful procurement information please read procedure 2210Z Effectiveness Factors under 7120 posted at: <http://www.caiso.com/Documents/2210Z.pdf>

3.2.2.4.4 Changes compared to last year’s results

Compared to 2028 load forecast went down by 55 MW. The LCR need went down by 241 MW mostly due to new transmission projects.

3.2.3 Sierra Area

3.2.3.1 Area Definition

The transmission tie lines into the Sierra Area are:

- Table Mountain-Rio Oso 230 kV line
- Table Mountain-Palermo 230 kV line
- Table Mt-Pease 60 kV line
- Caribou-Palermo 115 kV line
- Drum-Summit 115 kV line #1
- Drum-Summit 115 kV line #2
- Spaulding-Summit 60 kV line
- Brighton-Bellota 230 kV line
- Rio Oso-Lockeford 230 kV line
- Gold Hill-Eight Mile Road 230 kV line

Lodi-Eight Mile Road 230 kV line

Gold Hill-Lake 230 kV line

The substations that delineate the Sierra Area are:

Table Mountain is out Rio Oso is in

Table Mountain is out Palermo is in

Table Mt is out Pease is in

Caribou is out Palermo is in

Drum is in Summit Metering Station is out

Drum is in Summit Metering Station is out

Spaulding, Tamarak, Summit (PG&E) are in Summit Metering Station s out

Brighton is in Bellota is out

Rio Oso is in Lockeford is out

Gold Hill is in Eight Mile is out

Lodi is in Eight Mile is out

Gold Hill is in Lake is out

3.2.3.1.1 Sierra LCR Area Diagram

Figure 3.2-13 Sierra LCR Area

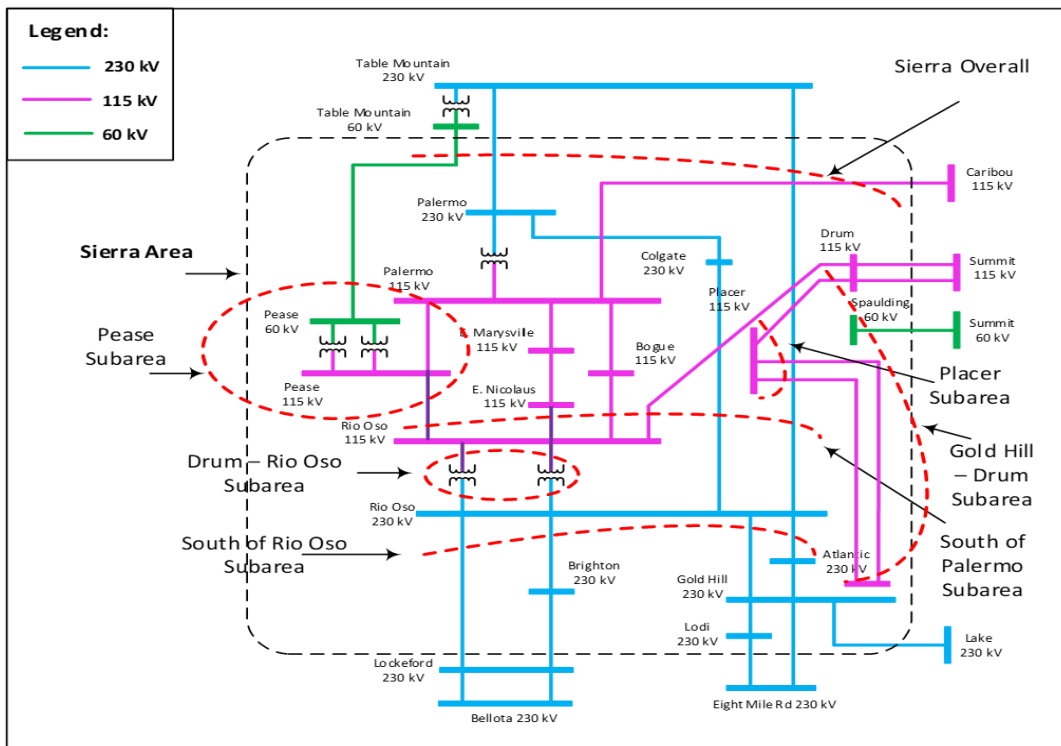

3.2.3.1.2 Sierra LCR Area Load and Resources

Table 3.2-9 provides the forecasted load and resources. The list of generators within the LCR area are provided in Attachment A.

In year 2029 the estimated time of local area peak is 19:00 PM.

At the local area peak time the estimated, ISO metered, solar output is 2.00%.

If required, all non-solar technology type resources are dispatched at NQC.

Table 3.2-9 Sierra LCR Area 2029 Forecast Load and Resources

Load (MW)		Generation (MW)	Aug NQC	At Peak
Gross Load	1939	Market/Net Seller	699	699
AAEE	-32	Battery	5	5
Behind the meter DG	0	MUNI/QF	1221	1221
Net Load	1907	Solar	0	0
Transmission Losses	71	Existing 20-minute Demand Response	0	0
Pumps	0	Mothballed	0	0
Load + Losses + Pumps	1978	Total	1925	1925

3.2.3.1.3 Approved transmission projects modeled:

- Rio Oso 230/115 kV transformer upgrade
- East Marysville 115/60 kV
- Rio Oso Area 230 kV Voltage Support
- Gold Hill 230/115 kV Transformer Addition
- Atlantic 230/60 kV transformer voltage regulator
- Reconductor Rio Oso–SPI Jct–Lincoln 115 kV line

3.2.3.2 Placer Sub-area

Placer is sub-area of the Sierra LCR area.

3.2.3.2.1 Placer LCR Sub-area Diagram

Figure 3.2-14 Placer LCR Sub-area

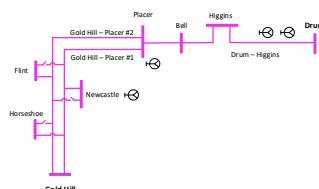

3.2.3.2.2 Placer LCR Sub-area Load and Resources

Table 3.2-10 provides the forecasted load and resources. The list of generators within the LCR sub-area are provided in Attachment A.

Table 3.2-10 Placer LCR Sub-area 2029 Forecast Load and Resources

Load (MW)		Generation (MW)	Aug NQC	At Peak
Gross Load	194	Market/NetSeller	36	36
AAEE	-3	Battery	0	0
Behind the meter DG	0	MUNI/QF	28	28
Net Load	191	Solar	0	0
Transmission Losses	3	Existing 20-minute Demand Response	0	0
Pumps	0	Mothballed	0	0
Load + Losses + Pumps	194	Total	64	64

3.2.3.2.3 Placer LCR Sub-area Hourly Profiles

Figure 3.2-15 illustrates the forecast 2029 profile for the peak day for the Placer LCR sub-area with the Category P6 normal and emergency capabilities without local resources. The chart also includes an estimated amount of energy storage that can be added to this local area from charging restriction perspective. Figure 3.2-16 illustrates the forecast 2029 hourly profile for Placer LCR sub-area with the Category P6 emergency load serving capability without local resources.

Figure 3.2-15 Placer LCR Sub-area 2029 Peak Day Forecast Profiles

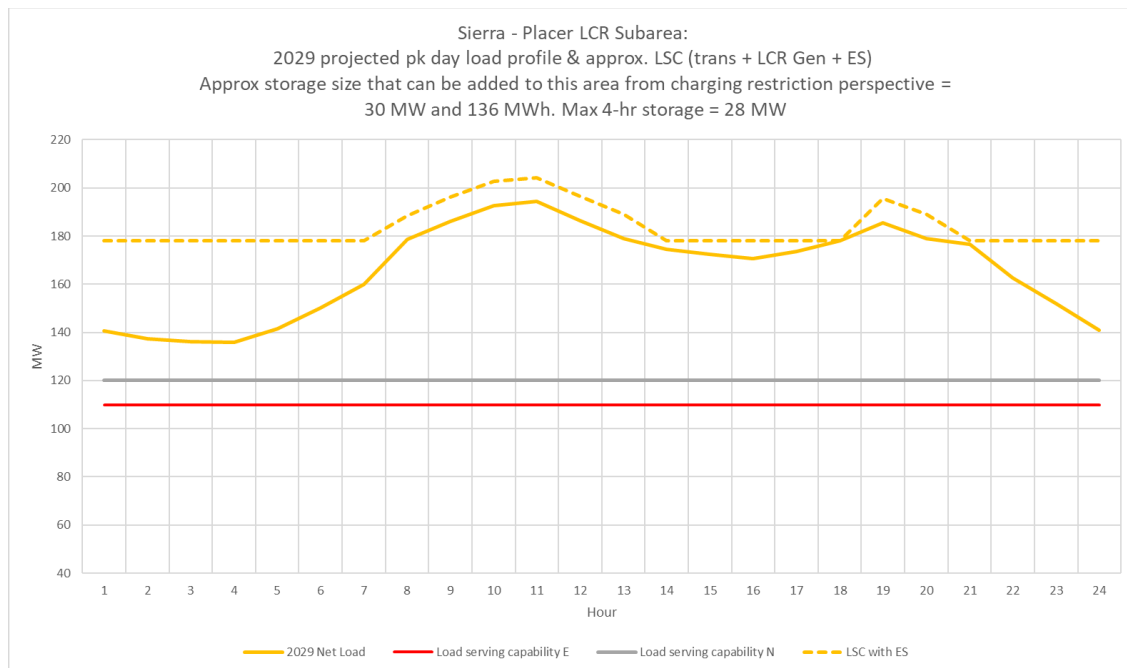
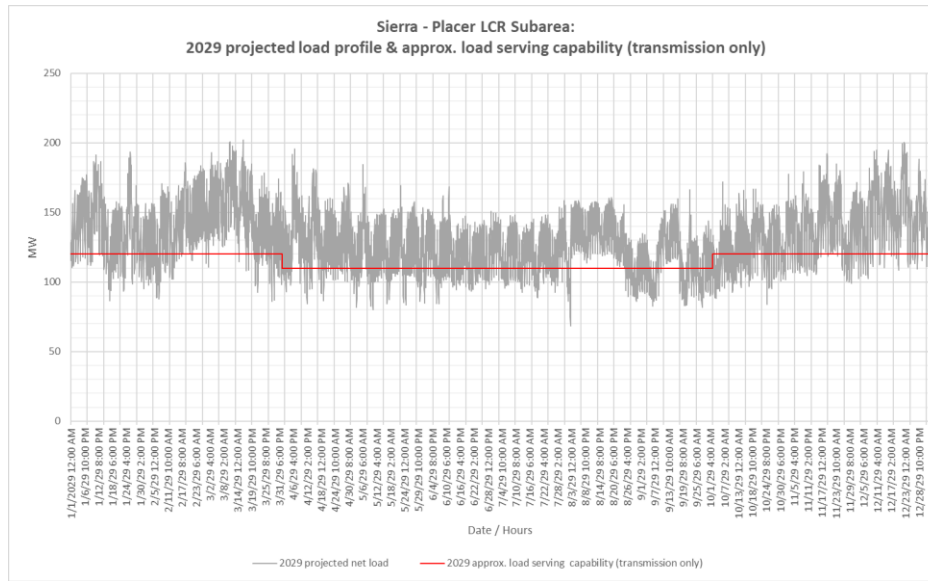

Figure 3.2-16 Placer LCR Sub-area 2029 Forecast Hourly Profiles



3.2.3.2.4 Placer LCR Sub-area Requirement

Table 3.2-11 identifies the sub-area LCR requirements. The LCR requirement for Category P6 contingency is 115 MW including 51 MW of NQC and peak deficiencies.

Table 3.2-11 Placer LCR Sub-area Requirements

Year	Limit	Category	Limiting Facility	Contingency	LCR (MW) (Deficiency)
2029	First Limit	P6	Drum-Higgins 115 kV	Gold Hill-Placer #1 115 kV & Gold Hill-Placer #2 115 kV	115 (51)

3.2.3.2.5 Effectiveness factors

All units within the Placer sub-area have the same effectiveness factor.

For most helpful procurement information please read procedure 2210Z Effectiveness Factors under 7240 posted at: <http://www.caiso.com/Documents/2210Z.pdf>

3.2.3.3 Pease Sub-area

Pease is sub-area of the Sierra LCR area.

Pease sub-area will be eliminated after the implementation of the of East Marysville 115/60 kV Development project.

3.2.3.4 Drum-Rio Oso Sub-area

Drum-Rio Oso is a sub-area of the Sierra LCR area.

Drum-Rio Oso sub-area will be eliminated after the Rio Oso 230/115 kV transformer upgrade transmission project.

3.2.3.5 Gold Hill-Drum Sub-area

Gold Hill-Drum is sub-area of the Sierra LCR Area.

Drum-Rio Oso sub-area will be eliminated after the Gold Hill 230/115 kV Transformer Addition Project.

3.2.3.6 South of Rio Oso Sub-area

South of Rio Oso is a sub-area of the Sierra LCR area.

3.2.3.6.1 South of Rio Oso LCR Sub-area Diagram

Figure 3.2-17 South of Rio Oso LCR Sub-area

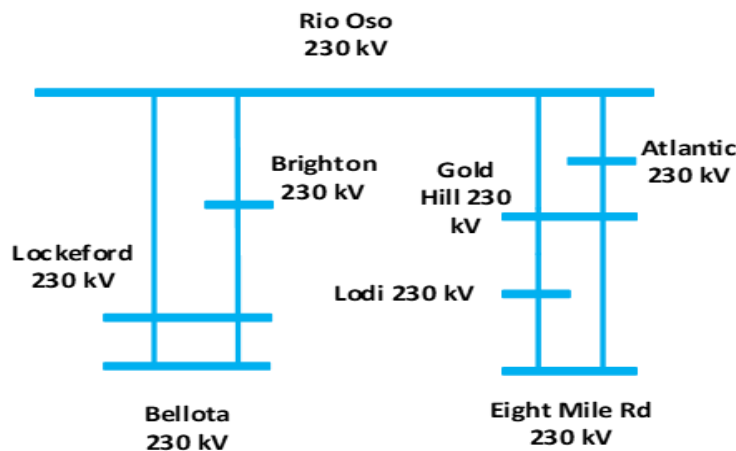

3.2.3.6.2 South of Rio Oso LCR Sub-area Load and Resources

The South of Rio Oso sub-area does not have a defined load pocket with the limits based upon power flow through the area. Table 3.2-12 provides the forecasted resources in the sub-area. The list of generators within the LCR area are provided in Attachment A.

Table 3.2-12 South of Rio Oso LCR Sub-area 2029 Forecast Load and Resources

Load (MW)	Generation (MW)	Aug NQC	At Peak
The South of Rio Oso Sub-area does not have a defined load pocket with the limits based upon power flow through the area.	Market/Net Seller	84	84
	Battery	0	0
	MUNI/QF	606	606
	Solar	0	0
	Existing 20-minute Demand Response	0	0
	Mothballed	0	0
	Total	690	690

3.2.3.6.3 South of Rio Oso LCR Sub-area Hourly Profiles

The South of Rio Oso sub-area does not have a defined load pocket with the limits based upon power flow through the area. As such, no load profile is provided for this sub-area.

3.2.3.6.4 South of Rio Oso LCR Sub-area Requirement

Table 3.2-13 identifies the sub-area LCR requirements. The LCR requirements for Category P6 contingency is 471 MW.

Table 3.2-13 South of Rio Oso LCR Sub-area Requirements

Year	Limit	Category	Limiting Facility	Contingency	LCR (MW) (Deficiency)
2029	First limit	P6	Rio Oso – Atlantic 230 kV	Rio Oso – Gold Hill 230 kV Rio Oso – Brighton 230 kV	471

3.2.3.6.5 Effectiveness factors:

Effectiveness factors for generators in the South of Rio Oso LCR sub-area are in Attachment B table titled [Rio Oso](#).

For other helpful procurement information please read procedure 2210Z Effectiveness Factors under 7230 posted at: <http://www.caiso.com/Documents/2210Z.pdf>

3.2.3.7 South of Palermo Sub-area

South of Palermo sub-area has been eliminated due to the South of Palermo transmission project.

3.2.3.8 Sierra Area Overall

3.2.3.8.1 Sierra LCR Area Hourly Profiles

The Sierra LCR area limits are based upon power flow through the area. As such, no load profile is provided for the area.

3.2.3.8.2 Sierra LCR Area Requirement

Table 3.2-14 identifies the area requirements. The LCR requirement for Category P6 contingency is 1885 MW.

Table 3.2-14 Sierra Area Requirements

Year	Limit	Category	Limiting Facility	Contingency	LCR (MW) (Deficiency)
2029	First limit	P6	Table Mountain – Pease 60 kV	Table Mountain – Palermo 230 kV Table Mountain – Rio Oso 230 kV	1885

3.2.3.8.3 Effectiveness factors:

Effectiveness factors for generators in the Sierra overall area are in Attachment B table titled [Sierra Overall](#).

For other helpful procurement information please read procedure 2210Z Effectiveness Factors under 7230 and 7240 posted at: <http://www.caiso.com/Documents/2210Z.pdf>

3.2.3.8.4 Changes compared to last year's results:

The load forecast went up by 135 MW. The total LCR need has increased by 470 MW mostly due to load forecast increase and due to the flow-through nature of the Sierra area.

3.2.4 Stockton Area

The LCR requirement for the Stockton area is driven by sum of the requirements for the Tesla-Bellota and Lockeford sub-areas.

3.2.4.1 Area Definition

Tesla-Bellota Sub-Area Definition

The transmission facilities that establish the boundary of the Tesla-Bellota sub-area are:

Bellota 230/115 kV Transformer #1

Bellota 230/115 kV Transformer #2

Tesla-Tracy 115 kV Line

Tesla-Salado 115 kV Line

Tesla-Salado-Manteca 115 kV line

Tesla-Schulte #1 115 kV Line

Tesla-Schulte #2 115kV line

The substations that delineate the Tesla-Bellota Sub-area are:

Bellota 230 kV is out Bellota 115 kV is in

Bellota 230 kV is out Bellota 115 kV is in

Tesla is out Tracy is in

Tesla is out Salado is in

Tesla is out Salado and Manteca are in

Tesla is out Schulte is in

Tesla is out Schulte is in

Lockeford Sub-Area Definition

The transmission facilities that establish the boundary of the Lockeford Sub -area are:

- Lockeford-Industrial 60 kV line
- Lockeford-Lodi #1 60 kV line
- Lockeford-Lodi #2 60 kV line
- Lockeford-Lodi #3 60 kV line

The substations that delineate the Lockeford Sub-area are:

- Lockeford is out Industrial is in
- Lockeford is out Lodi is in
- Lockeford is out Lodi is in
- Lockeford is out Lodi is in

3.2.4.1.1 Stockton LCR Area Diagram

The Stockton LCR area is comprised of the individual noncontiguous sub-areas with diagrams provided for each of the sub-areas below.

3.2.4.1.2 Stockton LCR Area Load and Resources

Table 3.2-15 provides the forecast load and resources in the area. The list of generators within the LCR area are provided in Attachment A.

In year 2029 the estimated time of local area peak is 19:10 PM.

At the local area peak time the estimated, ISO metered, solar output is 2.00%.

If required, all non-solar technology type resources are dispatched at NQC.

Table 3.2-15 Stockton LCR Area 2029 Forecast Load and Resources

Load (MW)		Generation (MW)	NQC	At Peak
Gross Load	921	Market/NetSeller	496	496
AAEE	-14	Battery	153	153
Behind the meter DG	0	MUNI/QF	101	101
Net Load	907	Solar	7	0
Transmission Losses	16	Existing 20-minute Demand Response	6	6
Pumps	0	Mothballed	0	0
Load + Losses + Pumps	923	Total	763	756

3.2.4.1.3 Stockton LCR Area Hourly Profiles

The Stockton LCR area is comprised of the individual noncontiguous sub-areas with profiles provided for each of the sub-areas below.

3.2.4.1.4 Approved transmission projects modeled

Lockeford – Lodi Area 230 kV Development Project

Banta 60 kV Bus Voltage Conversion

Vierra 115 kV Looping Project

Kasson – Kasson Junction 1 115 kV Line Section Reconductoring Project

Manteca-Ripon-Riverbank-Melones Area 115 kV Line Reconductoring Project

3.2.4.2 Lockeford Sub-area

Lockeford sub-area will be eliminated due to the implementation of the Lockeford – Lodi Area 230 kV Development project.

3.2.4.3 Stanislaus Sub-area

Stanislaus is a sub-area within the Tesla-Bellota sub-area of the Stockton LCR Area.

3.2.4.3.1 Stanislaus LCR Sub-area Diagram

Figure 3.2-18 Stanislaus LCR Sub-area

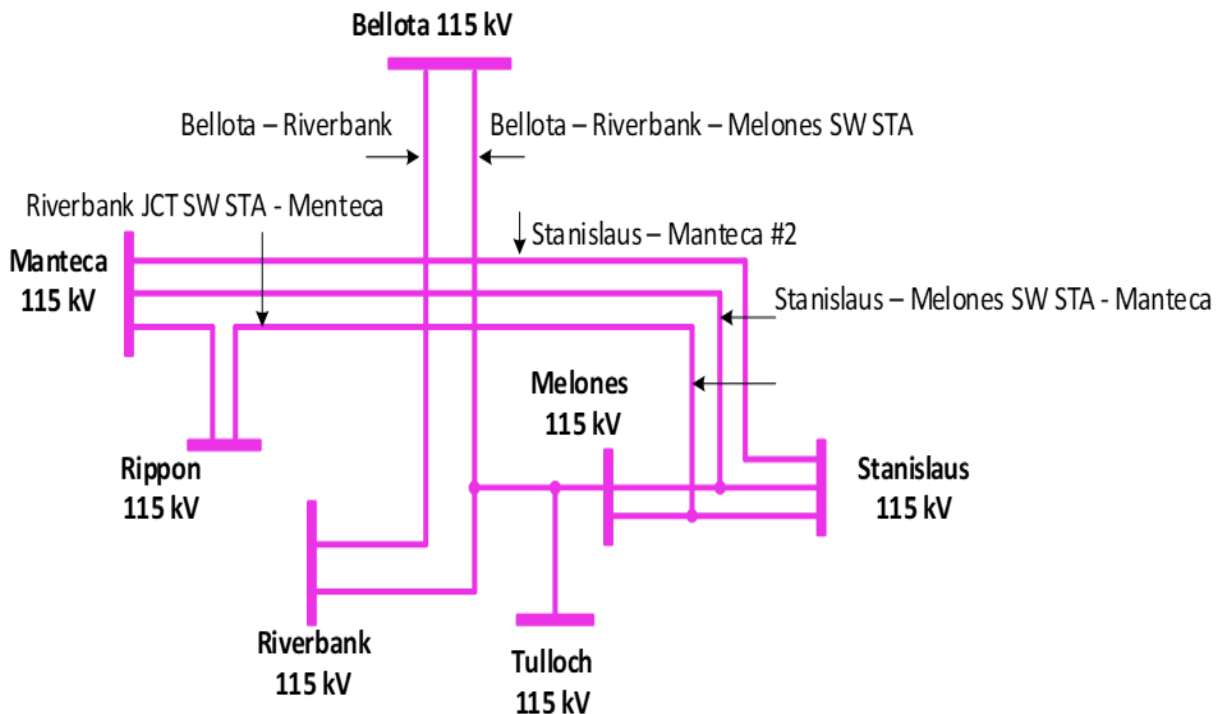

3.2.4.3.2 Stanislaus LCR Sub-area Load and Resources

The Stanislaus sub-area does not has a defined load pocket with the limits based upon power flow through the area. Table 3.2-16 provides the forecasted resources in the sub-area. The list of generators within the LCR sub-area are provided in Attachment A.

Table 3.2-16 Stanislaus LCR Sub-area 2029 Forecast Load and Resources

Load (MW)	Generation (MW)	Aug NQC	At Peak
The Stanislaus Sub-area does not has a defined load pocket with the limits based upon power flow through the area.	Market/Net Seller	94	94
	Battery	132	132
	MUNI/QF	82	82
	Solar	0	0
	Existing 20-minute Demand Response	0	0
	Mothballed	0	0
	Total	308	308

3.2.4.3.3 Stanislaus LCR Sub-area Hourly Profiles

The Stanislaus sub-area does not has a defined load pocket with the limits based upon power flow through the area. As such, no load profile is provided for this sub-area.

3.2.4.3.4 Stanislaus LCR Sub-area Requirement

Table 3.2-17 identifies the sub-area requirements. The LCR requirement for Category P3 contingency is 169 MW.

Table 3.2-17 Stanislaus LCR Sub-area Requirements

Year	Limit	Category	Limiting Facility	Contingency	LCR (MW) (Deficiency)
2029	First limit	P3	Vierra 115 kV – Manteca 115 kV	Bellota-Riverbank-Melones 115 kV and Stanislaus PH	169

3.2.4.3.5 Effectiveness factors:

All units within this sub-area have the same effectiveness factor.

For most helpful procurement information please read procedure 2210Z Effectiveness Factors under 7410 posted at: <http://www.caiso.com/Documents/2210Z.pdf>

3.2.4.4 Tesla-Bellota Sub-area

Tesla-Bellota is a sub-area of the Stockton LCR area.

3.2.4.4.1 Tesla-Bellota LCR Sub-area Diagram

Figure 3.2-19 Tesla-Bellota LCR Sub-area

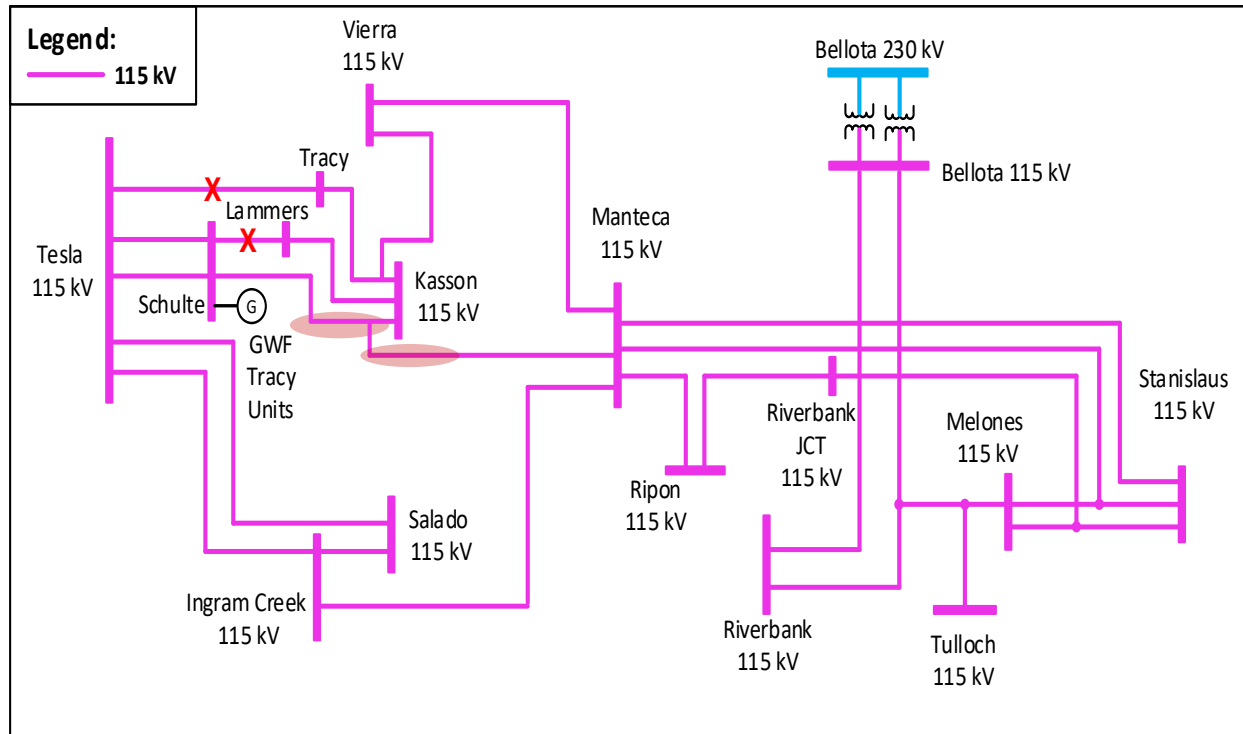

3.2.4.4.2 Tesla Bellota LCR Sub-area Load and Resources

Table 3.2-18 provides the forecasted load and resources. The list of generators within the LCR sub-area are provided in Attachment A.

Table 3.2-18 Tesla-Bellota LCR Sub-area 2029 Forecast Load and Resources

Load (MW)		Generation (MW)		Aug NQC	At Peak
Gross Load	921	Market/Net Seller		496	496
AAEE	-14	Battery		152	152
Behind the meter DG	0	MUNI/QF		101	101
Net Load	907	Solar		7	0
Transmission Losses	16	Existing 20-minute Demand Response		6	6
Pumps	0	Mothballed		0	0
Load + Losses + Pumps	923	Total		763	756

All of the resources needed to meet the Stanislaus sub-area count towards the Tesla-Bellota sub-area LCR need.

3.2.4.4.3 Tesla-Bellota LCR Sub-area Hourly Profiles

Figure 3.2-20 illustrates the forecast 2029 profile for the peak day for the Tesla-Bellota sub-area with the Category P6 normal and emergency load serving capabilities without local resources. The chart also includes an estimated amount of energy storage that can be added to this local area from charging restriction perspective. Figure 3.2-21 illustrates the forecast 2029 hourly profile for Tesla-Bellota sub-area with of the Category P6 emergency load serving capability without local resources.

Figure 3.2-20 Tesla-Bellota LCR Sub-area 2029 Peak Day Forecast Profiles

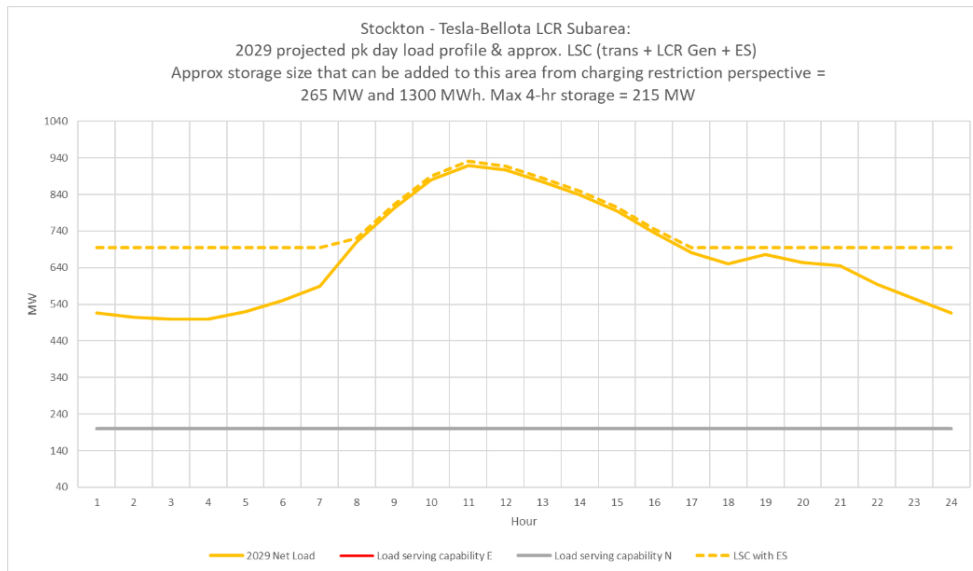
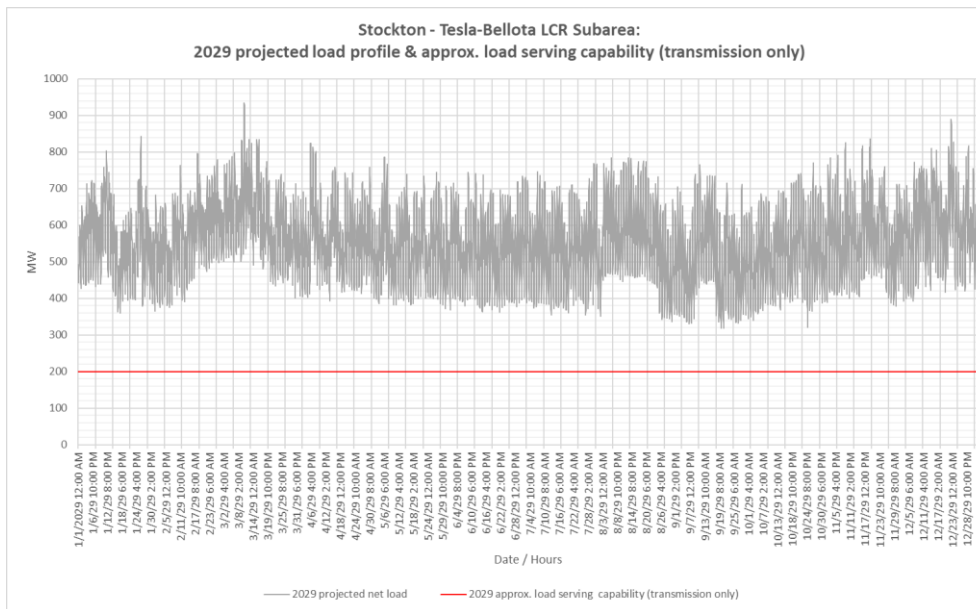

Figure 3.2-21 Tesla-Bellota LCR Sub-area 2029 Forecast Hourly Profile



3.2.4.4.4 Tesla-Bellota LCR Sub-area Requirement

Table 3.2-19 identifies the sub-area LCR requirements. The LCR requirement for Category P6 contingency is 991 MW including a 228 MW of NQC deficiency or 235 MW of at peak deficiency.

Table 3.2-19 Tesla-Bellota LCR Sub-area Requirements

Year	Limit	Category	Limiting Facility	Contingency	LCR (MW) (Deficiency)
2029	First limit	P2-4	Melones – Riverbank-Bellota 115 kV	Tesla 115 kV Bus Section 1D & 2D	690 (59 NQC/ 66 Peak)
2029	First limit	P6	Tesla-Tracy 115 kV	Schulte – Lammers 115 kV & Schulte-Lammers-Manteca 115 kV	655 (228 NQC/ 235 Peak)
Total LCR Need for Tesla – Bellota Sub-area in 2029					991 (228 NQC/ 235 Peak)

3.2.4.4.5 Effectiveness factors:

All units within this sub-area are needed therefore no effectiveness factor is required.

For most helpful procurement information please read procedure 2210Z Effectiveness Factors under 7410 posted at: <http://www.caiso.com/Documents/2210Z.pdf>

3.2.4.5 Stockton Overall

3.2.4.5.1 Stockton LCR Area Overall Requirement

The requirement for this area is driven by the requirement for the Tesla-Bellota and Lockeford sub-areas. Table 3.2-20 identifies the area requirements. The LCR requirement for Category P6 contingency is 991 MW with a 228 MW NQC deficiency or 235 at peak deficiency.

Table 3.2-20 Stockton LCR Sub-area Overall Requirements

Year	Limit	Category	Limiting Facility	Contingency	LCR (MW) (Deficiency)
2029		P6	Stockton Overall		991 (228 NQC/ 235 Peak)

3.2.4.5.2 Changes compared to last year’s study

Overall the load forecast went down by 26 MW, the total LCR need has reduced by 63 MW and the deficiency by 54 MW. The reduction is mainly due to reduced load forecast.

3.2.5 Greater Bay Area

3.2.5.1 *Area Definition:*

The transmission tie lines into the Greater Bay Area are:

Lakeville-Sobrante 230 kV
Ignacio-Sobrante 230 kV
Parkway-Moraga 230 kV
Bahia-Moraga 230 kV
Lambie SW Sta-Vaca Dixon 230 kV
Peabody-Contra Costa P.P. 230 kV
Tesla-Kelso 230 kV
Tesla-Delta Switching Yard 230 kV
Tesla-Pittsburg #1 230 kV
Tesla-Pittsburg #2 230 kV
Tesla-Newark #1 230 kV
Tesla-Newark #2 230 kV
Tesla-Ravenswood 230 kV
Collinsville-Pittsburg #1 230 kV
Collinsville-Pittsburg #2 230 kV
Tesla-Metcalf 500 kV
Moss Landing-Los Banos 500 kV
Moss Landing-Coburn #1 230 kV
Moss Landing-Las Aguilas #2 230 kV
Oakdale TID-Newark #1 115 kV
Oakdale TID-Newark #2 115 kV

The substations that delineate the Greater Bay Area are:

Lakeville is out Sobrante is in
Ignacio is out Sobrante is in
Parkway is out Moraga is in
Bahia is out Moraga is in
Lambie SW Sta is in Vaca Dixon is out
Peabody is out Contra Costa P.P. is in

- Tesla is out Kelso is in
- Tesla is out Delta Switching Yard is in
- Tesla is out Pittsburg is in
- Tesla is out Pittsburg is in
- Tesla is out Newark is in
- Tesla is out Newark is in
- Tesla is out Ravenswood is in
- Tesla is out Metcalf is in
- Los Banos is out Moss Landing is in
- Coburn is out Moss Landing is in
- Las Aguilas is out Moss Landing is in
- Oakdale TID is out Newark is in
- Oakdale TID is out Newark is in

3.2.5.1.1 Greater Bay LCR Area Diagram

Figure 3-22 Greater Bay LCR Area

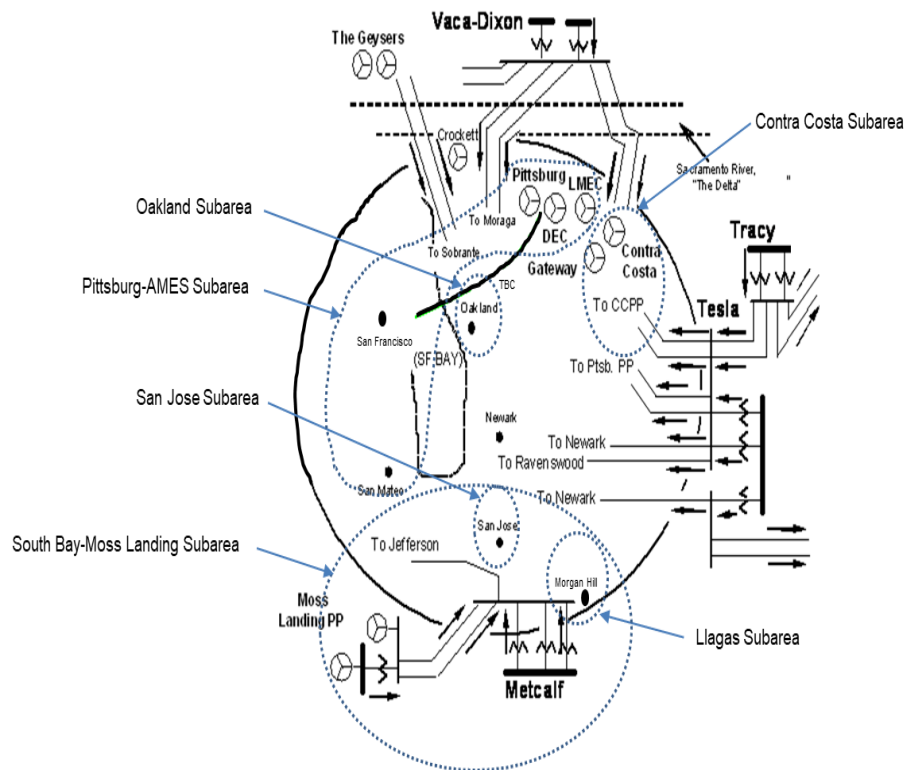

3.2.5.1.2 Greater Bay LCR Area Load and Resources

Table 3.2-21 provides the forecasted load and resources. The list of generators within the LCR area are provided in Attachment A.

In year 2029 the estimated time of local area peak is 17:30 PM.

At the local area peak time the estimated, ISO metered, solar output is 11.02%.

If required, all technology type resources, including solar, are dispatched at NQC.

Table 3.2-21 Greater Bay Area LCR Area 2029 Forecast Load and Resources

Load (MW)		Generation (MW)	Aug NQC	At Peak
Gross Load	12020	Market/Net Seller	6131	6131
AAEE	-144	Wind	248	248
Behind the meter DG	-119	Battery	1337	1337
Net Load	11757	MUNI/QF	604	604
Transmission Losses	312	Existing 20-minute Demand Response	65	65
Pumps	264	Solar	4	0
Load + Losses + Pumps	12333	Total	8389	8385

3.2.5.1.3 Approved transmission projects modeled

- Moraga – Castro Valley 230 kV Line capacity increase
- Vasona – Metcalf 230 kV Line limiting elements removal
- Oakland Clean Energy Initiative Project
- Ravenswood 230/115 kV Transformer #1 Limiting Facility Upgrade
- Newark – Milpitas #1 115 kV Line Limiting Facility Upgrade
- Series Compensation on Los Esteros – Nortech 115 kV Line
- Pittsburg 230/115 kV Transformer Capacity Increase
- Morgan Hill Area Reinforcement
 - Morgan Hill-Green Valley 115 kV line, normally closed
 - Morgan Hill 115 kV bus convert to a BAAH
- Newark 230/115 kV Transformer Bank #7 Circuit Breaker Addition
- San Jose Area HVDC Line (Newark-NRS)
- San Jose Area HVDC Line (Metcalf-San Jose)
- Christie-Sobrante 115 kV Line Reconductor

- New Collinsville 500 kV substation
- South of San Matero capacity increase
- Lone tree – Cayetano – Newark corridor series compensation

3.2.5.2 Llagas Sub-area

Llagas is a sub-area of the Greater Bay LCR area.

3.2.5.2.1 Llagas LCR Sub-area Diagram

Figure 3-23 Llagas LCR Sub-area

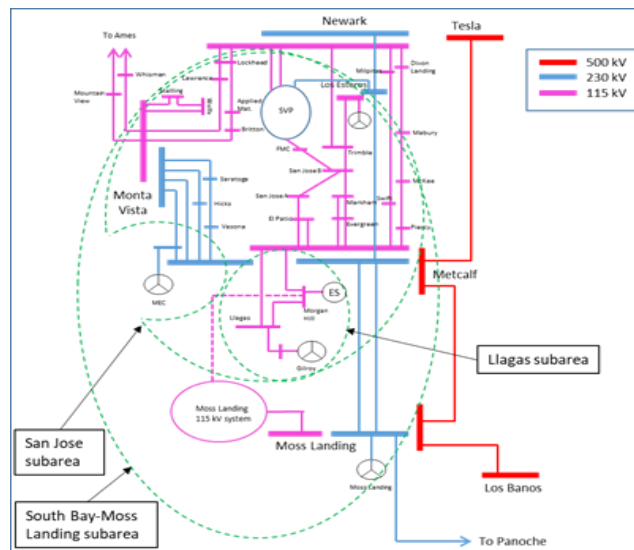

3.2.5.2.2 Llagas LCR Sub-area Load and Resources

Table 3.2-22 provides the forecasted load and resources. The list of generators within the LCR sub-area are provided in Attachment A.

Table 3.2-22 Llagas LCR Sub-area 2029 Forecast Load and Resources

Load (MW)		Generation (MW)		Aug NQC	At Peak
Gross Load	253	Market/Net Seller		256	256
AEE	-3	Battery		20	20
Behind the meter DG	-3	MUNI/QF		0	0
Net Load	248	Solar		0	0
Transmission Losses	1	Existing 20-minute Demand Response		0	0
Pumps	0	Mothballed		0	0
Load + Losses + Pumps	249	Total		276	276

3.2.5.2.3 Llagas LCR Sub-area Hourly Profiles

Figure 3-24 illustrates the forecast 2029 profile for the peak day for the Llagas LCR sub-area with the Category P6 normal and emergency load serving capabilities without local resources. The chart also includes an estimated amount of energy storage that can be added to this local area from charging restriction perspective. Figure 3-25 illustrates the forecast 2029 hourly profile for Llagas LCR sub-area with the Category P6 emergency load serving capability without local resources.

Figure 3-24 Llagas LCR Sub-area 2029 Peak Day Forecast Profiles

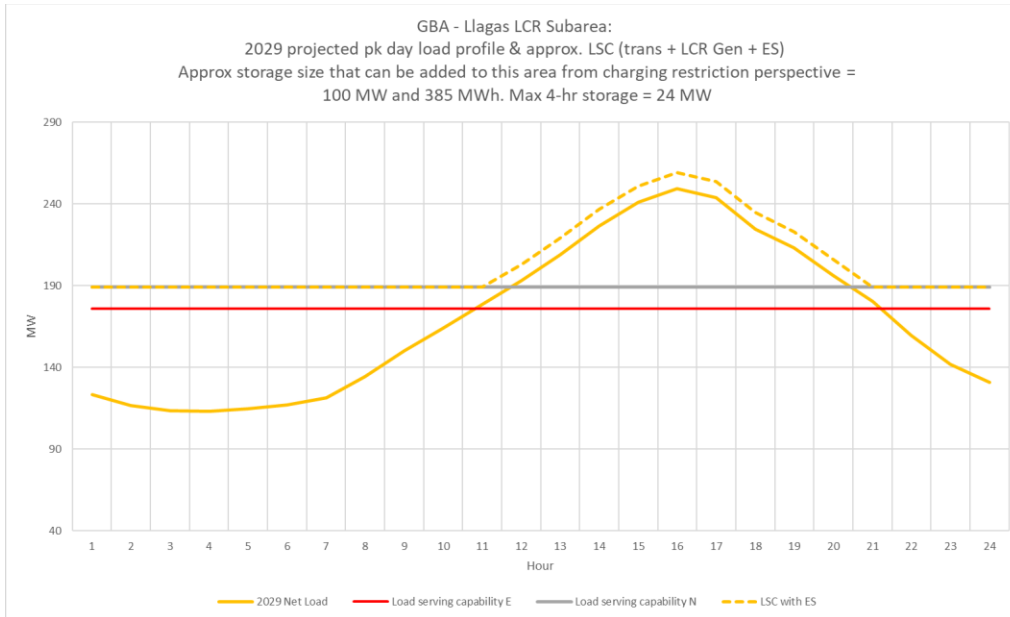
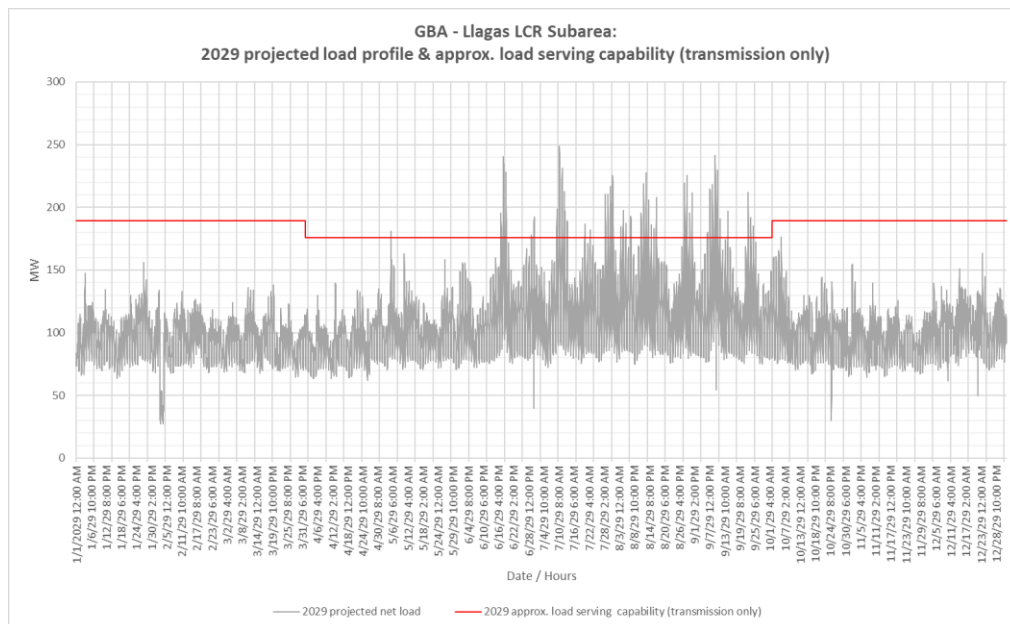

Figure 3-25 Llagas LCR Sub-area 2029 Forecast Hourly Profiles



3.2.5.2.4 Llagas LCR Sub-area Requirement

Table 3.2-23 identifies the sub-area LCR requirements. The LCR requirement for the Category P6 contingency is 131 MW.

Table 3.2-23 Llagas LCR Sub-area Requirements

Year	Limit	Category	Limiting Facility	Contingency	LCR (MW)
2029	First limit	P6	Metcalf-Llagas 115 kV line	Metcalf-Morgan Hill & Morgan Hill-Green Valley 115 kV lines	80

3.2.5.2.5 Effectiveness factors:

All units within this sub-area have the same effectiveness factor.

3.2.5.3 San Jose Sub-area

San Jose is a sub-area of the Greater Bay LCR area.

3.2.5.3.1 San Jose LCR Sub-area Diagram

The San Jose LCR sub-area is identified in Figure 3-23.

3.2.5.3.2 San Jose LCR Sub-area Load and Resources

Table 3.2-24 provides the forecast load and resources in San Jose LCR sub-area. The list of generators within the LCR sub-area are provided in Attachment A.

Table 3.2-24 San Jose LCR Sub-area 2029 Forecast Load and Resources

Load (MW)		Generation (MW)	Aug NQC	At Peak
Gross Load	3259	Market/NetSeller	584	584
AAEE	-34	Battery	95	95
Behind the meter DG	-22	MUNI/QF	197	197
Net Load	3204	Solar	0	0
Transmission Losses	84	Existing 20-minute Demand Response	0	0
Pumps	0	Mothballed	0	0
Load + Losses + Pumps	3288	Total	876	876

3.2.5.3.3 San Jose LCR Sub-area Hourly Profiles

Figure 3-26 illustrates the forecast 2029 profile for the peak day for the San Jose LCR sub-area with the Category P2 normal and emergency load serving capabilities without local resources. The chart also includes an estimated amount of energy storage that can be added to this local

area from charging restriction perspective. Figure 3-27 illustrates the forecast 2029 hourly profile for San Jose LCR sub-area with the Category P2 emergency load serving capability without local resources.

Figure 3-26 San Jose LCR Sub-area 2029 Peak Day Forecast Profiles

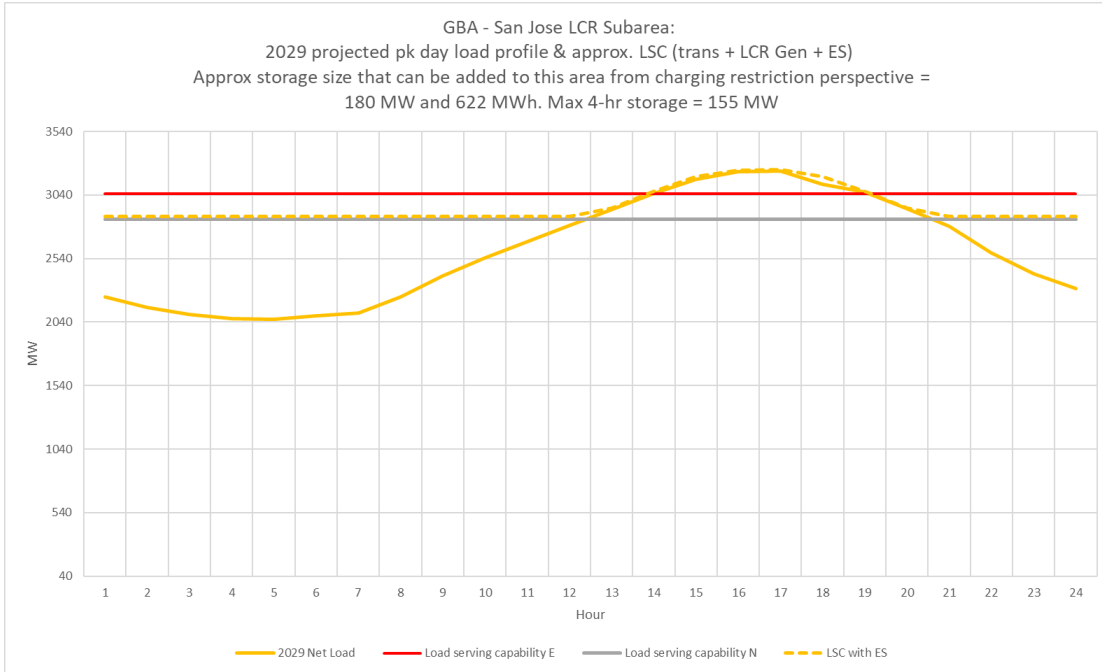
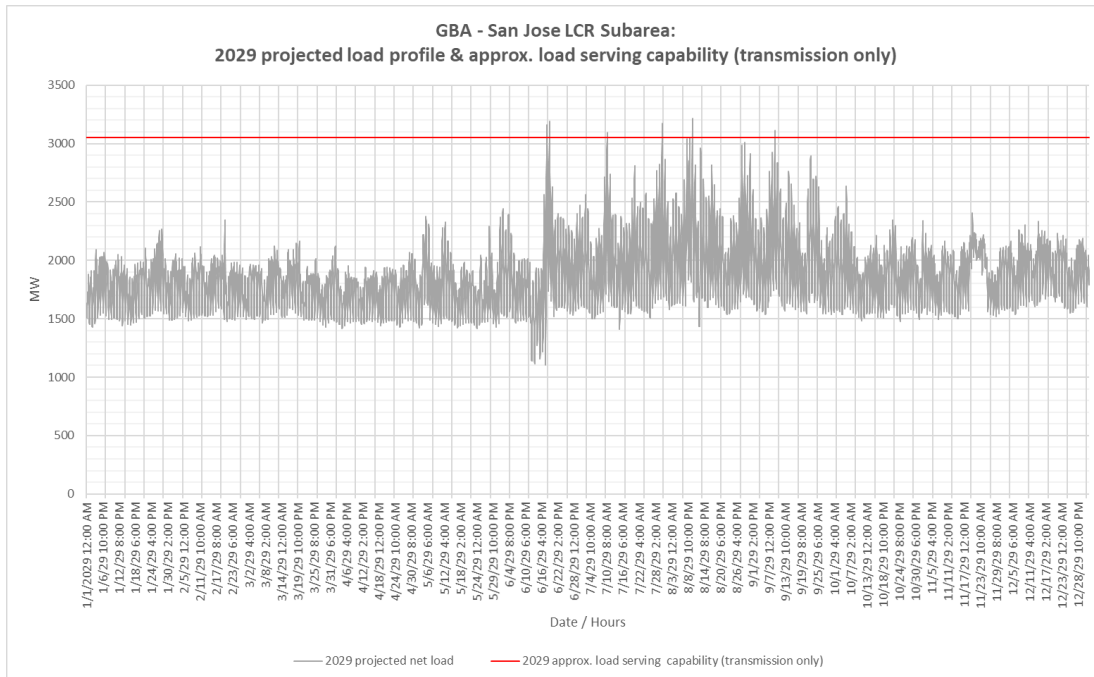

Figure 3-27 San Jose LCR Sub-area 2029 Forecast Hourly Profiles



3.2.5.3.4 San Jose LCR Sub-area Requirement

Table 3.2-25 identifies the sub-area LCR requirements. The LCR requirement for the Category P2 contingency is 183 MW.

Table 3.2-25 San Jose LCR Sub-area Requirements

Year	Limit	Category	Limiting Facility	Contingency	LCR (MW) (Deficiency)
2029	First limit	P2	Metcalf 230/115 kV transformer # 1 or #3	Metcalf 230 kV Bus Section 2D & 2E	183

3.2.5.3.5 Effectiveness factors:

Effectiveness factors for generators in the San Jose LCR sub-area are in Attachment B table titled [San Jose](#).

For other helpful procurement information please read procedure 2210Z Effectiveness Factors under 7320 posted at: <http://www.caiso.com/Documents/2210Z.pdf>

3.2.5.4 South Bay-Moss Landing Sub-area

South Bay-Moss Landing is a sub-area of the Greater Bay LCR area.

3.2.5.4.1 South Bay-Moss Landing LCR Sub-area Diagram

The South Bay-Moss Landing LCR sub-area is identified in Figure 3-23.

3.2.5.4.2 South Bay-Moss Landing LCR Sub-area Load and Resources

Table 3.2-26 provides the forecast load and resources in South Bay-Moss Landing LCR sub-area. The list of generators within the LCR sub-area are provided in Attachment A.

Table 3.2-26 South Bay-Moss Landing LCR Sub-area 2029 Forecast Load and Resources

Load (MW)		Generation (MW)	Aug NQC	At Peak
Gross Load	4886	Market/NetSeller	2201	2201
AAEE	-58	Battery	1038	1038
Behind the meter DG	-47	MUNI/QF	197	197
Net Load	4781	Solar	0	0
Transmission Losses	129	Existing 20-minute Demand Response	0	0
Pumps	0	Mothballed	0	0
Load + Losses + Pumps	4910	Total	3436	3436

3.2.5.4.3 South Bay-Moss Landing LCR Sub-area Hourly Profiles

Figure 3-28 illustrates the forecast 2029 profile for the peak day for the South Bay-Moss Landing LCR sub-area with the Category P6 normal and emergency load serving capabilities without local resources. The chart also includes an estimated amount of energy storage that can be added to this local area from charging restriction perspective. Figure 3-29 illustrates the forecast 2029 hourly profile for South Bay-Moss Landing LCR sub-area with the Category P6 emergency load serving capability without local resources.

Figure 3-28 South Bay-Moss Landing LCR Sub-area 2029 Peak Day Forecast Profiles

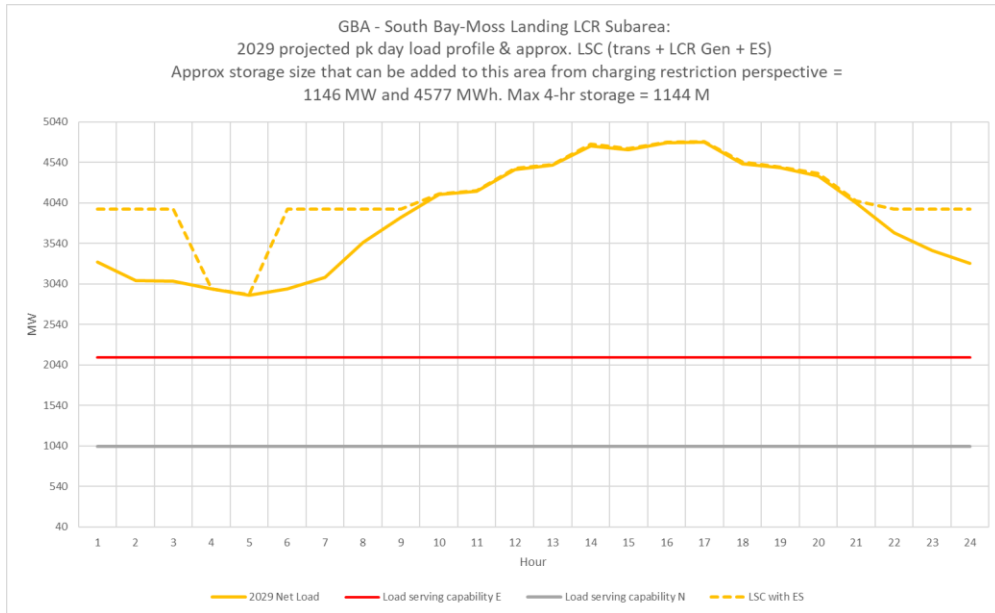
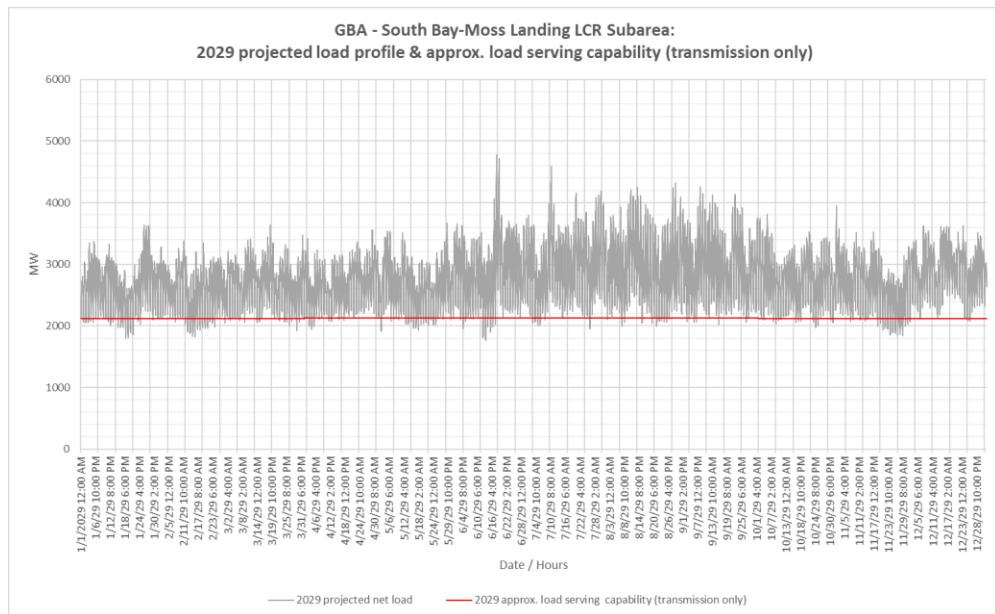

Figure 3-29 South Bay-Moss Landing LCR Sub-area 2029 Forecast Hourly Profiles



3.2.5.4.4 South Bay-Moss Landing LCR Sub- Requirement

Table 3.2-27 identifies the sub-area LCR requirements. The LCR requirement for the Category P6 contingency is 2334 MW.

Table 3.2-27 South Bay-Moss Landing LCR Sub-area Requirements

Year	Limit	Category	Limiting Facility	Contingency	LCR (MW)
2029	First Limit	P6	Moss Landing-Las Aguilas 230 kV line	Tesla-Metcalf 500 kV and Moss Landing-Los Banos 500 kV lines	2334

3.2.5.4.5 Effectiveness factors:

Effectiveness factors for generators in the South Bay-Moss Landing LCR sub-area are in Attachment B table titled [South Bay-Moss Landing](#).

For other helpful procurement information please read procedure 221 0Z Effectiveness Factors under 7320 (T-165Z) posted at: <http://www.caiso.com/Documents/2210Z.pdf>

3.2.5.5 Oakland Sub-area

Oakland is a sub-area of the Greater Bay LCR area.

3.2.5.5.1 Oakland LCR Sub-area Diagram

Figure 3-30 Oakland LCR Sub-area

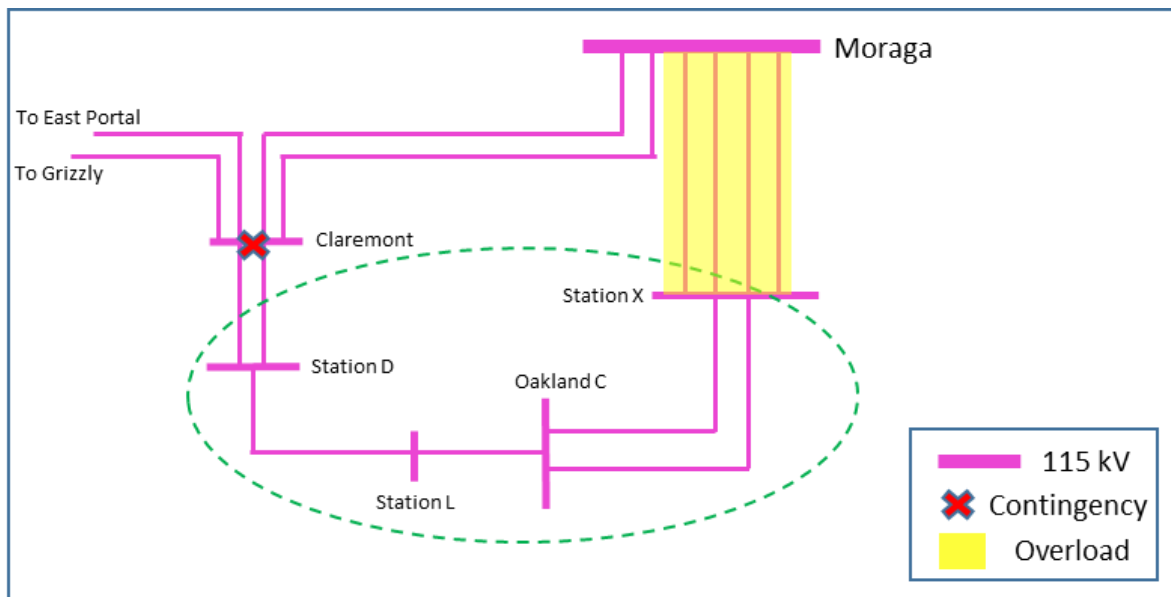

3.2.5.5.2 Oakland LCR Sub-area Load and Resources

Table 3.2-28 provides the forecast load and resources in Oakland LCR sub-area. The list of generators within the LCR sub-area are provided in Attachment A.

Table 3.2-28 Oakland LCR Sub-area 2029 Forecast Load and Resources

Load (MW)		Generation (MW)	Aug NQC	At Peak
Gross Load	441	Market/NetSeller	110	110
AAEE	-5	Battery	0	0
Behind the meter DG	-3	MUNI/QF	49	49
Net Load	433	Solar	0	0
Transmission Losses	1	Existing 20-minute Demand Response	0	0
Pumps	0	Mothball	0	0
Load + Losses + Pumps	434	Total	159	159

3.2.5.5.3 Oakland LCR Sub-area Hourly Profiles

Figure 3-31 illustrates the forecasted 2029 profile for the peak day for the Oakland LCR sub-area with the Category P6 normal and emergency load serving capabilities without local resources. The chart also includes an estimated amount of energy storage that can be added to this local area from charging restriction perspective. Figure 3-32 illustrates the forecast 2029 hourly profile for Oakland LCR sub-area with the Category P6 emergency load serving capability without local resources.

Figure 3-31 Oakland LCR Sub-area 2029 Peak Day Forecast Profiles

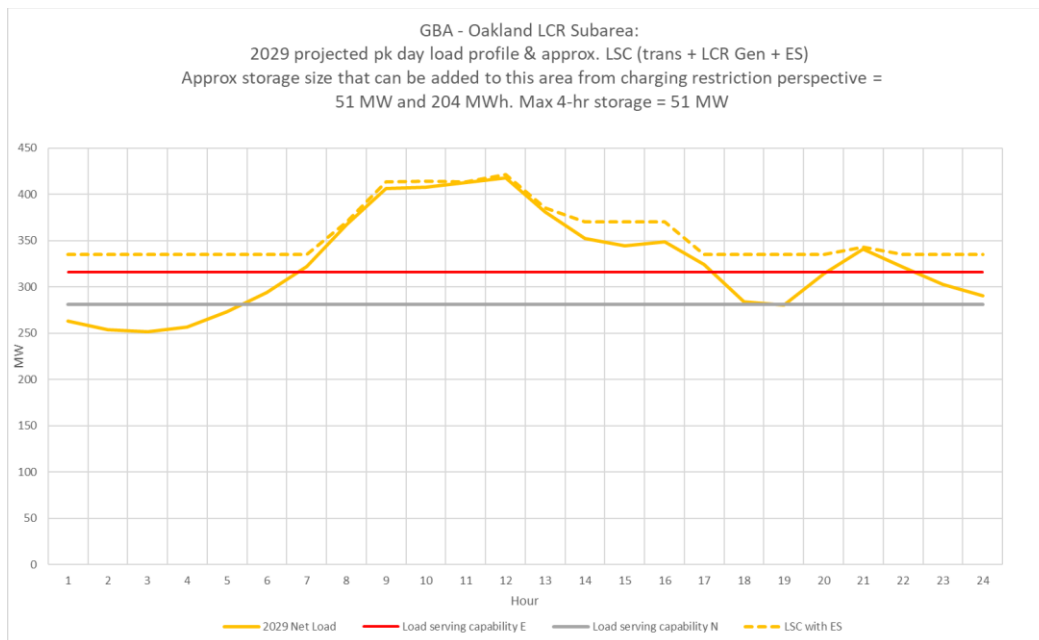
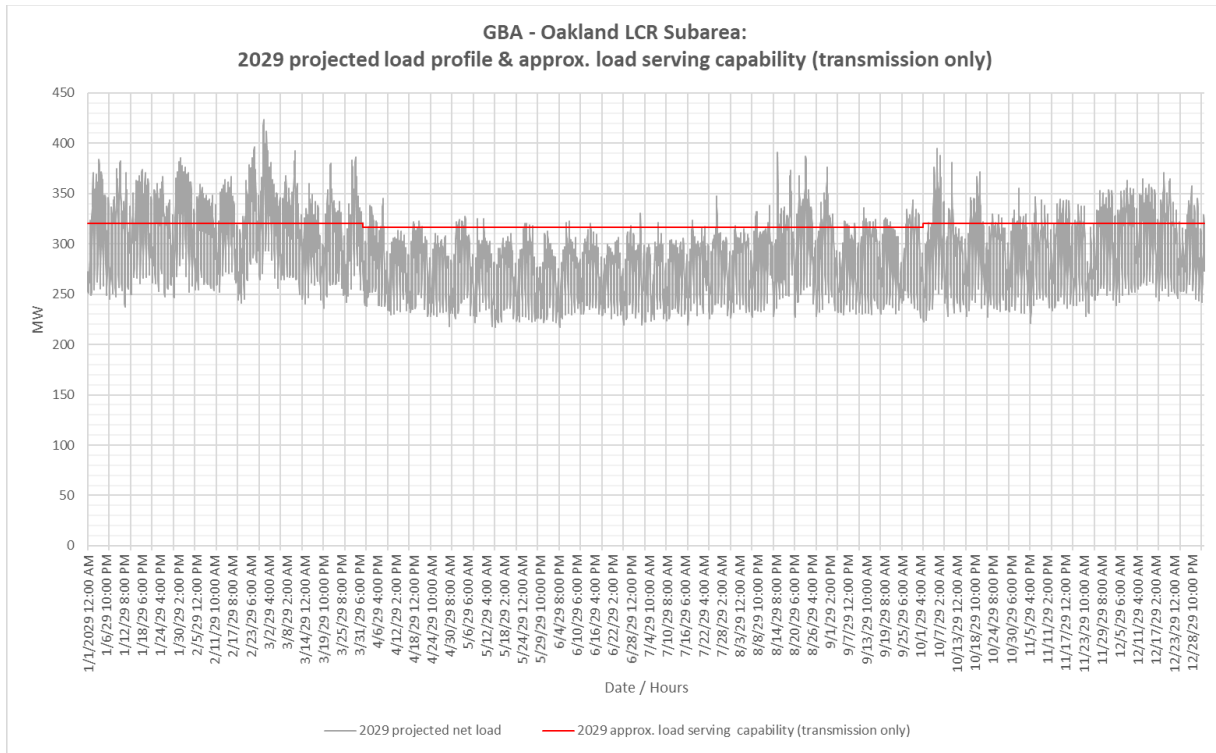

Figure 3-32 Oakland LCR Sub-area 2029 Forecast Hourly Profiles



3.2.5.5.4 Oakland LCR Sub-area Requirement

Table 3.2-29 identifies the sub-area requirements. The LCR requirement for the Category P6 contingency is 103 MW.

Table 3.2-29 Oakland LCR Sub-area Requirements

Year	Limit	Category	Limiting Facility	Contingency	LCR (MW)
2029	First limit	P2	Moraga – Oakland X#1 - #4 115 kV lines	Claremont 115 kV Bus Section 1D & 2D	103

3.2.5.5.5 Effectiveness factors:

All units within the Oakland sub-area have the same effectiveness factor.

For most helpful procurement information please read procedure 2210Z Effectiveness Factors under 7320 posted at: <http://www.caiso.com/Documents/2210Z.pdf>

3.2.5.6 Ames-Pittsburg-Oakland Sub-areas Combined

Ames-Pittsburg-Oakland is a sub-area of the Greater Bay LCR area.

3.2.5.6.1 Ames-Pittsburg-Oakland LCR Sub-area Diagram

Figure 3-33 Ames-Pittsburg-Oakland LCR Sub-area

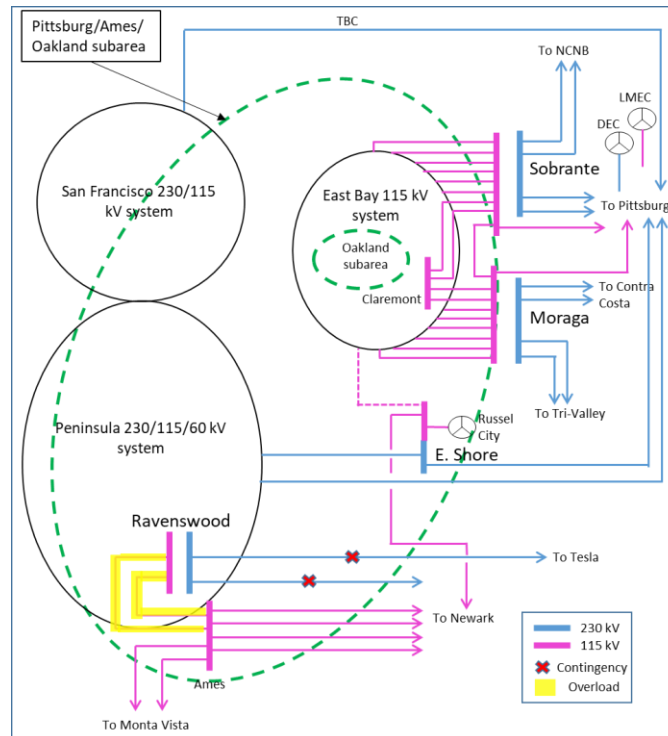

3.2.5.6.2 Ames-Pittsburg-Oakland LCR Sub-area Load and Resources

Table 3.2-30 provides the forecast load and resources in Ames-Pittsburg-Oakland LCR sub-area. The list of generators within the LCR sub-area are provided in Attachment A.

Table 3.2-30 Ames-Pittsburg-Oakland LCR Sub-area 2029 Forecast Load and Resources

Load (MW)	Generation (MW)	Aug NQC	At Peak
The Ames-Pittsburg-Oakland Sub-area does not has a defined load pocket with the limits based upon power flow through the area.	Market/Net Seller	2266	2266
	Battery	200	200
	MUNI/QF	274	274
	Solar	2	0
	Existing 20-minute Demand Response	0	0
	Mothball	0	0
	Total		2742

3.2.5.6.3 Ames-Pittsburg-Oakland LCR Sub-area Hourly Profiles

The Ames-Pittsburg-Oakland Sub-area does not have a defined load pocket with the limits based upon power flow through the area. As such, no load profile is provided for this sub-area.

3.2.5.6.4 Ames-Pittsburg-Oakland LCR Sub-area Requirement

Table 3.2-31 identifies the sub-area LCR requirements. The LCR requirement for the Category P7 or P2 contingency is 1409 MW.

Table 3.2-31 Ames-Pittsburg-Oakland LCR Sub-area Requirements

Year	Limit	Category	Limiting Facility	Contingency	LCR (MW)
2029	First limit	P6	Ames – Ravenswood #1 & #2 115 kV lines	Newark-Ravenswood 230 kV & Tesla-Ravenswood 230 kV lines	1409

3.2.5.6.5 Effectiveness factors:

For other helpful procurement information please read procedure 2210Z Effectiveness Factors under 7320 (T-165Z) posted at: <http://www.caiso.com/Documents/2210Z.pdf>

3.2.5.7 Contra Costa Sub-area

Contra Costa is a sub-area of the Greater Bay LCR area.

3.2.5.7.1 Contra Costa LCR Sub-area Diagram

Figure 3-34 Contra Costa LCR Sub-area

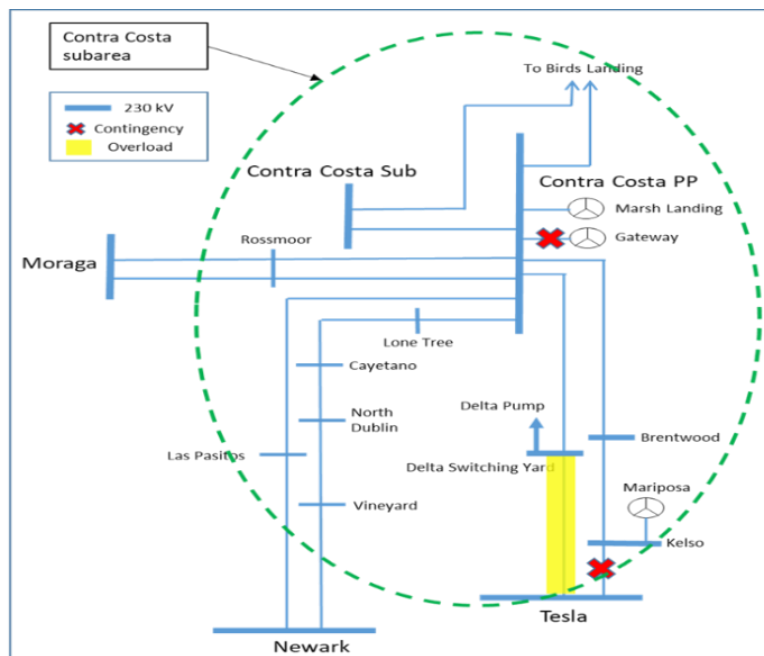

3.2.5.7.2 Contra Costa LCR Sub-area Load and Resources

Table 3.2-32 provides the forecast load and resources in Contra Costa LCR sub-area. The list of generators within the LCR sub-area are provided in Attachment A.

Table 3.2-32 Contra Costa LCR Sub-area 2029 Forecast Load and Resources

Load (MW)	Generation (MW)	Aug NQC	At Peak
The Contra Costa Sub-area does not has a defined load pocket with the limits based upon power flow through the area.	Market, Net Seller, Battery, Solar	1662	1662
	Wind	248	248
	Battery	100	100
	MUNI/QF	127	127
	Existing 20-minute Demand Response	0	0
	Solar	0	0
	Total	2137	2137

3.2.5.7.3 Contra Costa LCR Sub-area Hourly Profiles

The Contra Costa Sub-area does not have a defined load pocket with the limits based upon power flow through the area. As such, no load profile is provided for this sub-area.

3.2.5.7.4 Contra Costa LCR Sub-area Requirement

Table 3.2-33 identifies the sub-area LCR requirements. The LCR requirement for the Category P3 contingency is 438 MW.

Table 3.2-33 Contra Costa LCR Sub-area Requirements

Year	Limit	Category	Limiting Facility	Contingency	LCR (MW)
2029	First limit	P3	Delta Switching Yard-Tesla 230 kV line	Kelso-Tesla 230 kV line and Gateway unit	438

3.2.5.7.5 Effectiveness factors:

For other helpful procurement information please read procedure 2210Z Effectiveness Factors under 7230 (T-165Z) posted at: <http://www.caiso.com/Documents/2210Z.pdf>

3.2.5.8 Bay Area overall

3.2.5.8.1 Bay Area LCR Area Hourly Profiles

Figure 3-35 illustrates the forecast 2029 profile for the peak day for the Bay Area LCR area with the Category P6 normal and emergency load serving capabilities without local resources. The

chart also includes an estimated amount of energy storage that can be added to this local area from charging restriction perspective. Figure 3-36 illustrates the forecast 2029 hourly profile for Bay Area LCR area with the Category P6 emergency load serving capability without local resources.

Figure 3-35 Bay Area LCR Area 2029 Peak Day Forecast Profiles

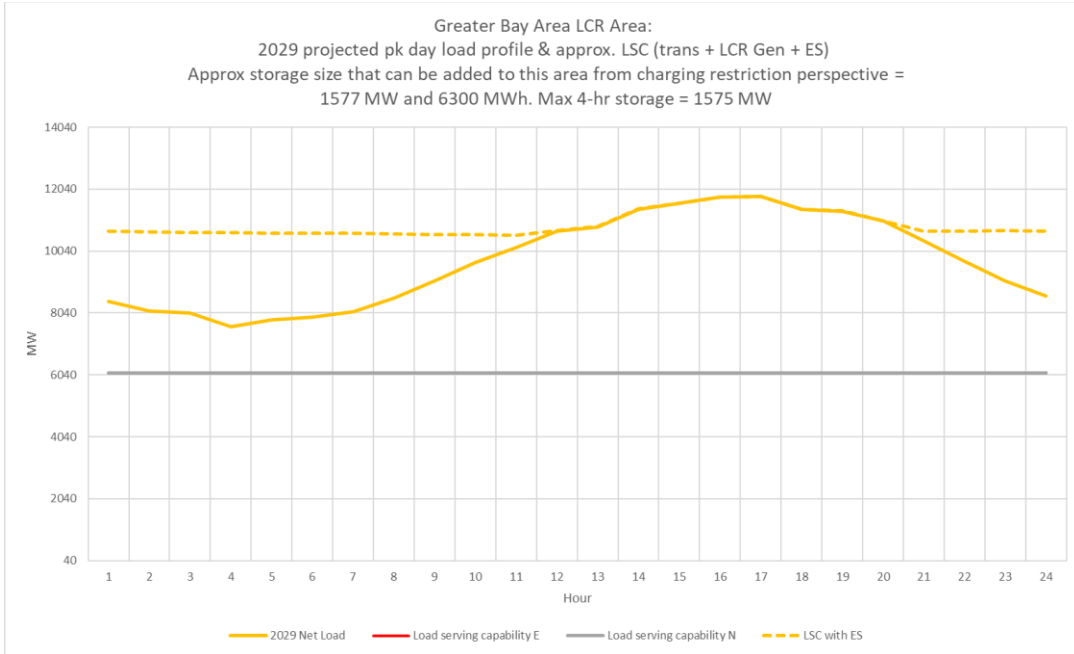
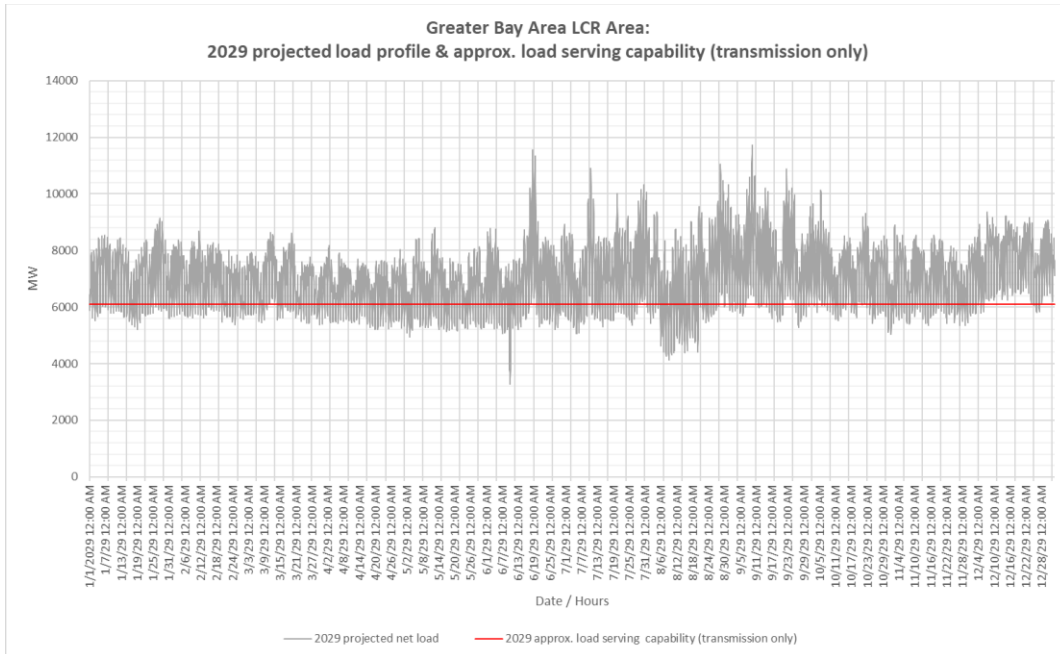

Figure 3-36 Bay Area LCR Area 2029 Forecast Hourly Profiles



3.2.5.8.2 Greater Bay LCR Area Overall Requirement

Table 3.2-34 identifies the area LCR requirements. The LCR requirement for the Category P6 contingency is 6259 MW.

Table 3.2-34 Bay Area LCR Overall area Requirements

Year	Limit	Category	Limiting Facility	Contingency	LCR (MW)
2029	First limit	P6	Moss Landing-Las Aguilas #1 230 kV line	Tesla-Metcalf & Moss Landing-Los Banos 500 kV lines	6259

3.2.5.8.3 Changes compared to last year’s study

Load forecast went up by 576 MW and total LCR need went down by 2 MW, practically the same due to new transmission projects in this area.

3.2.6 Greater Fresno Area

3.2.6.1 Area Definition:

The transmission facilities coming into the Greater Fresno area are:

- Gates-Mustang #1 230 kV
- Gates-Mustang #2 230 kV
- Gates #5 230/70 kV Transformer Bank
- Mercy Spring 230 /70 Bank # 1
- Los Banos #3 230/70 Transformer Bank
- Los Banos #4 230/70 Transformer Bank
- Pole Line 230/70 Transformer Bank
- Warnerville-Wilson 230kV
- Melones-North Merced 230 kV line
- Panoche-Tranquility #1 230 kV
- Panoche-Tranquility #2 230 kV
- Panoche #1 230/115 kV Transformer Bank
- Panoche #2 230/115 kV Transformer Bank
- Corcoran-Smyrna 115kV
- Coalinga #1-San Miguel 70 kV

The substations that delineate the Greater Fresno area are:

- Gates is out Mustang is in
- Gates is out Mustang is in
- Gates 230 is out Gates 70 is in
- Mercy Springs 230 is out Mercy Springs 70 is in
- Los Banos 230 is out Los Banos 70 is in
- Los Banos 230 is out Los Banos 70 is in
- Pole Line 230 is out Pole Line 70 is in
- Warnerville is out Wilson is in
- Melones is out North Merced is in
- Panoche is out Tranquility #1 is in
- Panoche is out Tranquility #2 is in
- Panoche 230 is out Panoche 115 is in
- Panoche 230 is out Panoche 115 is in
- Corcoran is in Smyrna is out
- Coalinga is in San Miguel is out

3.2.6.1.1 Fresno LCR Area Diagram

Figure 3.2-37 Fresno LCR Area

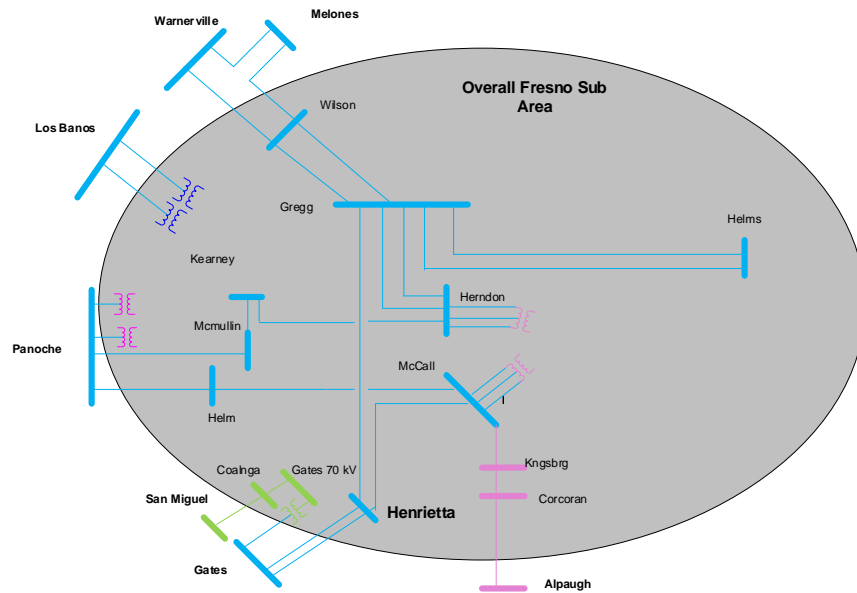

3.2.6.1.2 Fresno LCR Area Load and Resources

Table 3.2-35 provides the forecast load and resources in Fresno LCR Area in 2029. The list of generators within the LCR sub-area are provided in Attachment A.

In year 2029 the estimated time of local area peak is 19:20 PM.

At the local area peak time the estimated, ISO metered, solar output is 0.00%.

If required, all non-solar technology type resources are dispatched at NQC.

Table 3.2-35 Fresno LCR Area 2029 Forecast Load and Resources

Load (MW)		Generation (MW)	Aug NQC	At Peak
Gross Load	3832	Market/NetSeller, Battery	2382	2382
AAEE	-57	Battery/Hybrid	457	457
Behind the meter DG	-150	MUNI/QF	229	229
Net Load	3625	Solar	199	0
Transmission Losses	148	Existing 20-minute Demand Response	0	0
Pumps	0	Mothballed	0	0
Load + Losses + Pumps	3773	Total	3267	3051

3.2.6.1.3 Approved transmission projects modeled

- Wilson 115 kV Area Reinforcement (Jan 2028)
- Oro Loma 70 kV Area Reinforcement (Jan 2027)
- Giffen Line Reconductoring (Completed)
- Borden 230/70 kV Transformer Bank #1 Capacity Increase (April 2026)
- Wilson-Oro Loma 115 kV Line Reconductoring (May 2027)
- Bellota-Warnerville 230 kV Reconductoring (April 2024)
- Herndon-Bullard #1 and #2 115 kV Reconductoring (Dec 2026)
- Coppermine 70 kV Reinforcement Project (May 2027)
- Panoche – Oro Loma 115 kV Line Reconductoring (April 2024)
- Henrietta 230/115 kV Bank 3 Replacement (June 2027)
- Los Banos 70 kV Area Reinforcement (Dec 2028)
- Borden-Storey #1 and #2 230 kV Line Reconductoring (May 2029)

3.2.6.2 Hanford Sub-area

Hanford is a sub-area of the Fresno LCR area.

3.2.6.2.1 Hanford LCR Sub-area Diagram

Figure 3.2-38 Hanford LCR Sub-area

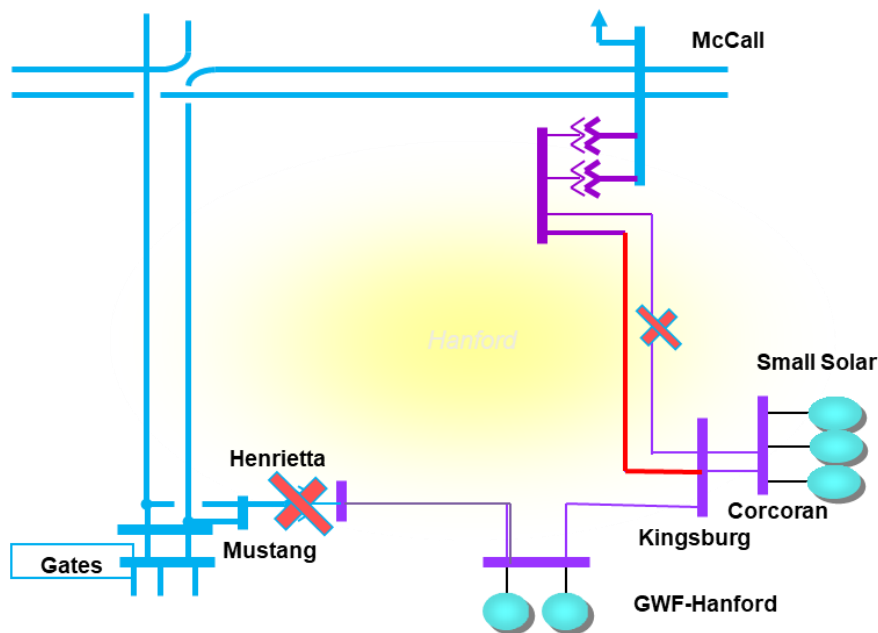

3.2.6.2.2 Hanford LCR Sub-area Load and Resources

Table 3.2-36 provides the forecast load and resources in Hanford LCR sub-area. The list of generators within the LCR sub-area are provided in Attachment A.

Table 3.2-36 Hanford LCR Sub-area 2029 Forecast Load and Resources

Load (MW)		Generation (MW)	Aug NQC	At Peak
Gross Load	228	Market/NetSeller	133	133
AAEE	-3	Battery	0	0
Behind the meter DG	-9	MUNI/QF	0	0
Net Load	216	Solar	28	0
Transmission Losses	7	Existing 20-minute Demand Response	0	0
Pumps	0	Mothballed	0	0
Load + Losses + Pumps	223	Total	161	133

3.2.6.2.3 Hanford LCR Sub-area Hourly Profiles

Figure 3.2-39 illustrates the forecast 2029 profile for the peak day for the Hanford LCR sub-area with the Category P6 normal and emergency load serving capabilities without local resources. The chart also includes an estimated amount of energy storage that can be added to this local area from charging restriction perspective. Figure 3.2-40 illustrates the forecast 2029 hourly

profile for Hanford LCR sub-area with the Category P6 emergency load serving capability without local resources.

Figure 3.2-39 Hanford LCR Sub-area 2029 Peak Day Forecast Profiles

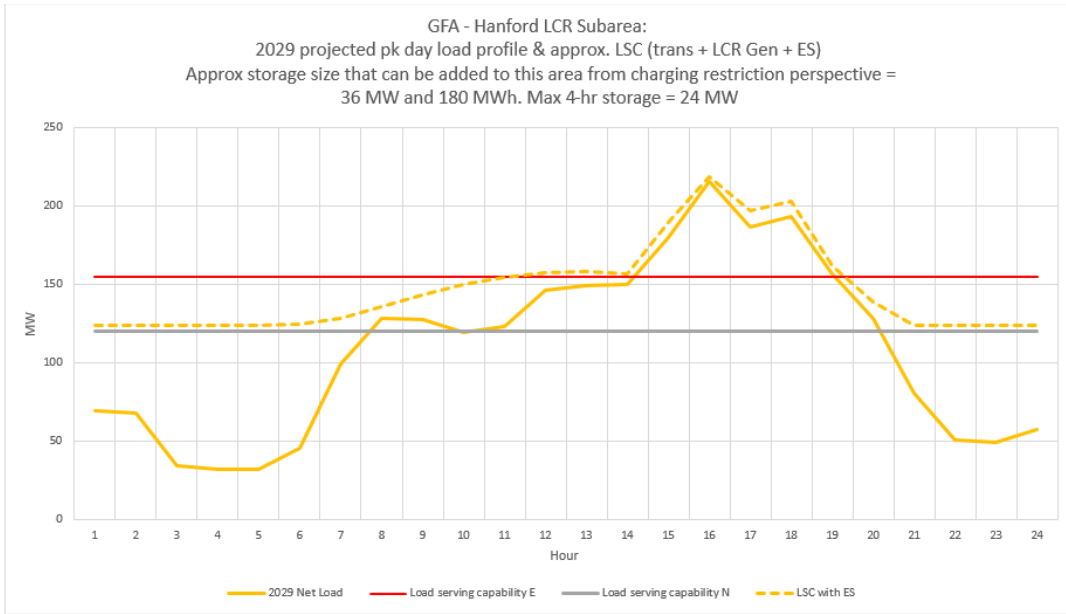
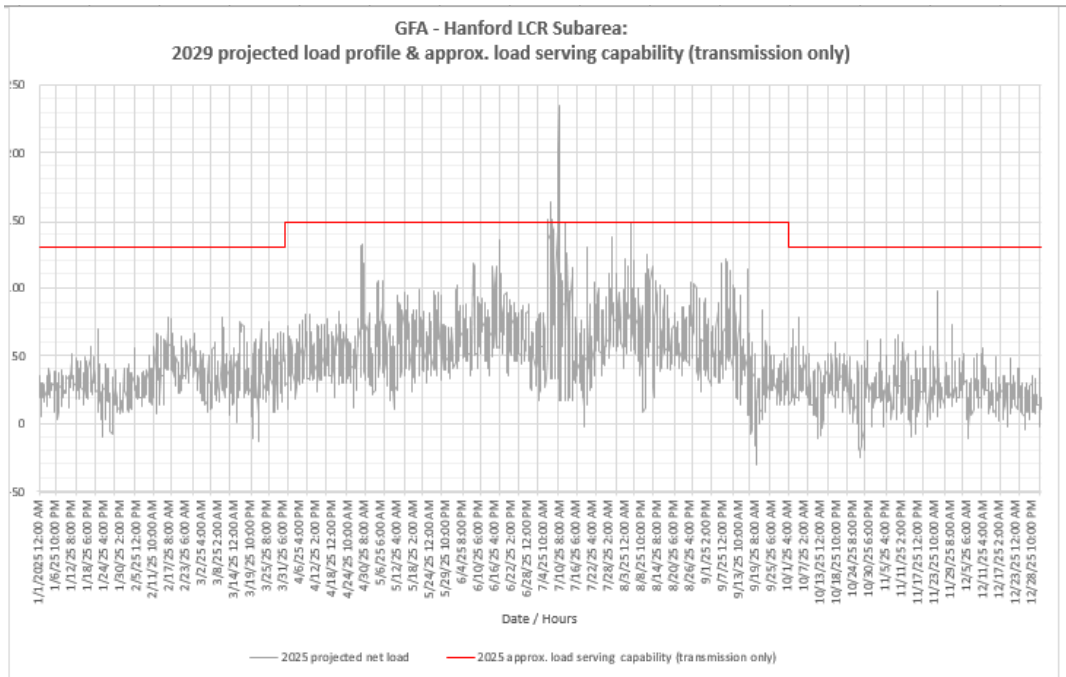

Figure 3.2-40 Hanford LCR Sub-area 2029 Forecast Hourly Profiles



3.2.6.2.4 Hanford LCR Sub-area Requirement

Table 3.2-37 identifies the sub-area requirements. The LCR Requirement for a Category P6 contingency is 36 MW.

Table 3.2-37 Hanford LCR Sub-area Requirements

Year	Limit	Category	Limiting Facility	Contingency	LCR (MW) (Deficiency)
2029	First Limit	P6	Kingsburg-Contadina 115 kV	McCall-Kingsburg #1 115kV line and McCall-Kingsburg #2 115kV line	36

3.2.6.2.5 **Effectiveness factors:**

All units within the Hanford sub-area have the same effectiveness factor.

For most helpful procurement information please read procedure 2210Z Effectiveness Factors under 7430 posted at: <http://www.caiso.com/Documents/2210Z.pdf>

3.2.6.3 **Coalinga Sub-area**

Coalinga is a sub-area of the Fresno LCR area.

3.2.6.3.1 **Coalinga LCR Sub-area Diagram**

Figure 3.2-41 Coalinga LCR Sub-area

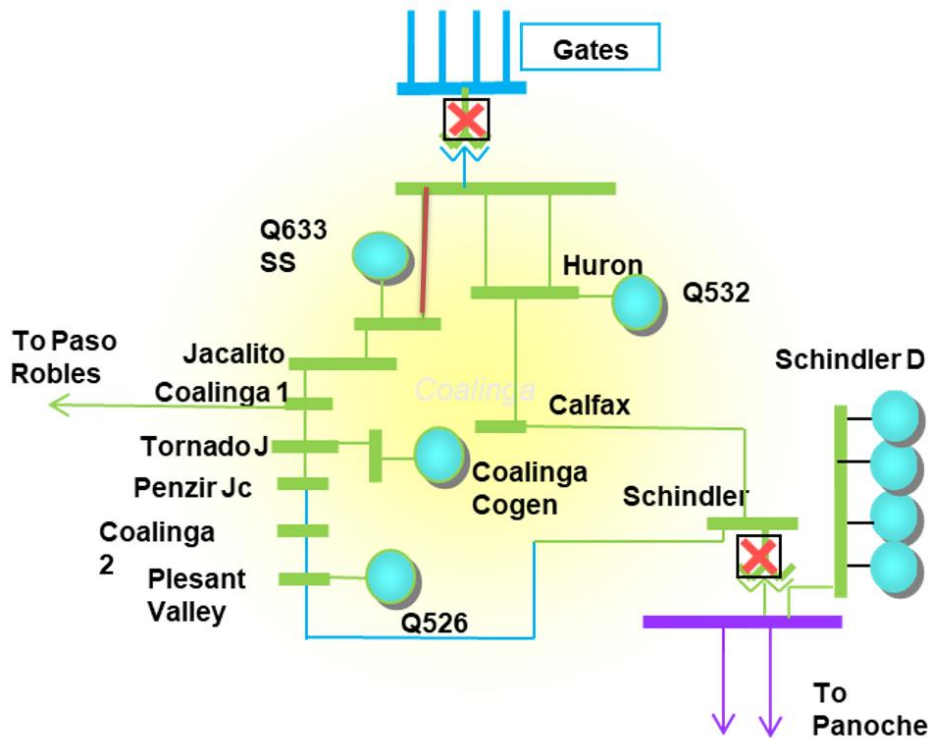

3.2.6.3.2 **Coalinga LCR Sub-area Load and Resources**

Table 3.2-38 provides the forecast load and resources in Coalinga LCR sub-area. The list of generators within the LCR sub-area are provided in Attachment A.

Table 3.2-38 Coalinga LCR Sub-area 2029 Forecast Load and Resources

Load (MW)		Generation (MW)	Aug NQC	At Peak
Gross Load	138	Market/NetSeller	0	0
AAEE	-1	Battery	10	10
Behind the meter DG	-4	MUNI/QF	3	3
Net Load	133	Solar	14	0
Transmission Losses	1	Existing 20-minute Demand Response	0	0
Pumps	0	Mothballed	0	0
Load + Losses + Pumps	134	Total	27	13

3.2.6.3.3 Coalinga LCR Sub-area Hourly Profiles

Figure 3.2-42 illustrates the forecast 2029 profile for the peak day for the Coalinga LCR sub-area with the Category P6 normal and emergency load serving capabilities without local resources. The chart also includes an estimated amount of energy storage that can be added to this local area from charging restriction perspective. Figure 3.2-43 illustrates the forecast 2029 hourly profile for Coalinga LCR sub-area with the Category P6 emergency load serving capability without local resources.

Figure 3.2-42 Coalinga LCR Sub-area 2029 Peak Day Forecast Profiles

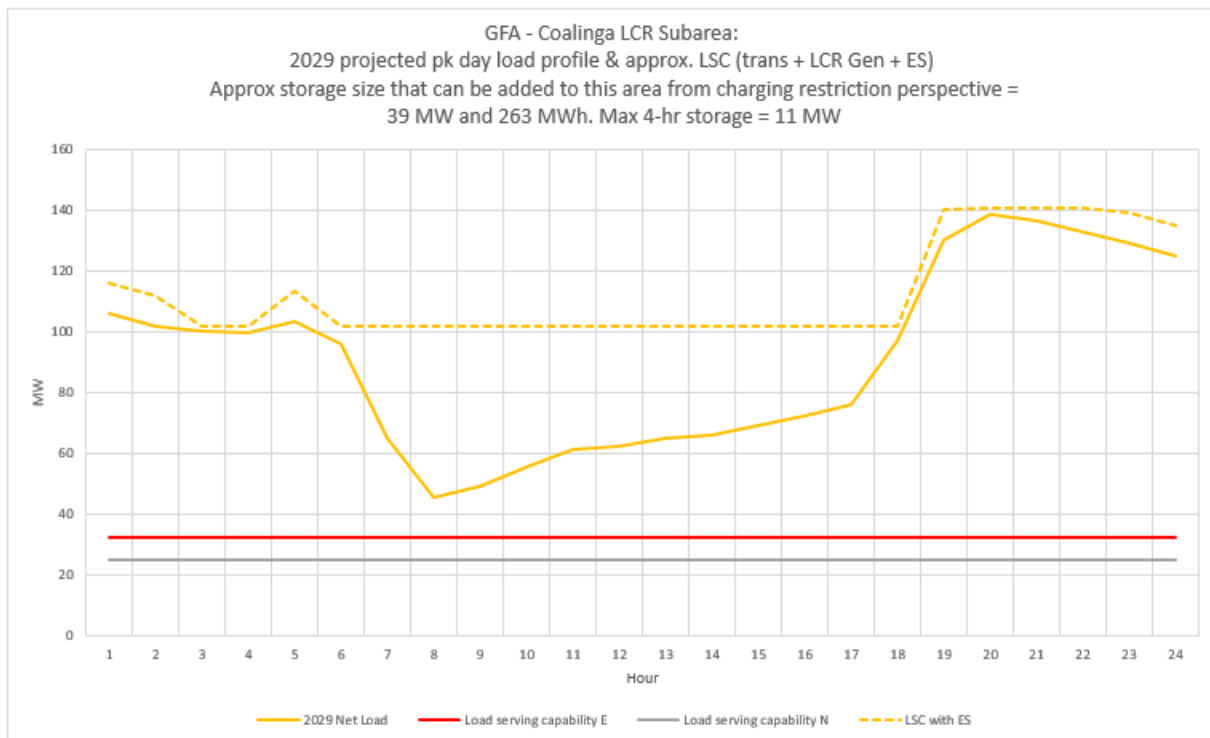
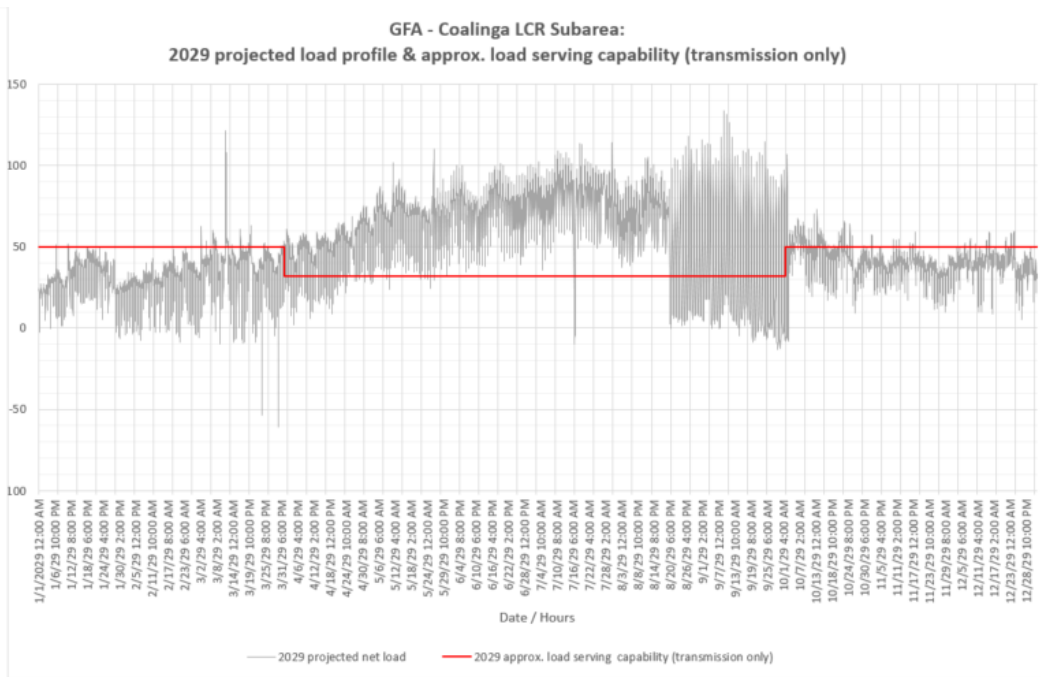

Figure 3.2-43 Coalinga LCR Sub-area 2029 Forecast Hourly Profiles



3.2.6.3.4 Coalinga LCR Sub-area Requirement

Table 3.2-39 identifies the sub-area requirements. The LCR Requirement for a Category P6 contingency is 101 MW including a 88 MW deficiency at peak and 74 MW deficiency for NQC.

Table 3.2-39 Coalinga LCR Sub-area Requirements

Year	Limit	Category	Limiting Facility	Contingency	LCR (MW) (Deficiency)
2029	First Limit	P6	Overload on San-Miguel-Coalinga 70kV Line and Voltage Instability	T-1/T-1: Gates 230/70kV TB #5 and Schindler 115/70 kV TB#1	101 (88 Peak) (74 NQC)

3.2.6.3.5 Effectiveness factors:

All units within the Coalinga sub-area have the same effectiveness factor.

For most helpful procurement information please read procedure 2210Z Effectiveness Factors under 7430 posted at: <http://www.caiso.com/Documents/2210Z.pdf>

3.2.6.4 Borden Sub-area

Borden sub-area has been eliminated due to Borden 230/70kV Transfer Bank #1 Capacity increase project.

3.2.6.5 Reedley Sub-area

Reedley is a sub-area of the Fresno LCR area.

3.2.6.5.1 Reedley LCR Sub-area Diagram

Figure 3.2-44 Reedley LCR Sub-area

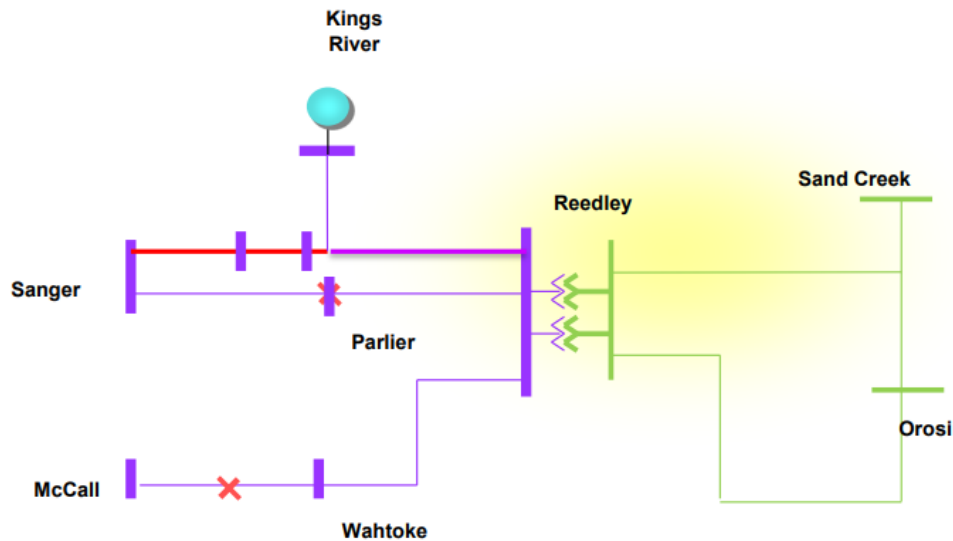

3.2.6.5.2 Reedley LCR Sub-area Load and Resources

Table 3.2-40 provides the forecast load and resources in Reedley LCR sub-area. The list of generators within the LCR sub-area are provided in Attachment A.

Table 3.2-40 Reedley LCR Sub-area 2029 Forecast Load and Resources

Load (MW)		Generation (MW)	Aug NQC	At Peak
Gross Load	253	Market/NetSeller	41	41
AAEE	-4	Battery	0	0
Behind the meter DG	-11	MUNI/QF	0	0
Net Load	238	LTPP Preferred Resources	0	0
Transmission Losses	67	Existing 20-minute Demand Response	0	0
Pumps	0	Mothballed	0	0
Load + Losses + Pumps	305	Total	41	41

3.2.6.5.3 Reedley LCR Sub-area Hourly Profiles

Figure 3.2-45 illustrates the forecast 2029 profile for the peak day for the Reedley LCR sub-area with the Category P6 normal and emergency load serving capabilities without local resources. The chart also includes an estimated amount of energy storage that can be added to this local area from charging restriction perspective. Figure 3.2-46 illustrates the forecast 2029 hourly

profile for Reedley LCR sub-area with the Category P6 emergency load serving capability without local resources.

Figure 3.2-45 Reedley LCR Sub-area 2029 Peak Day Forecast Profiles

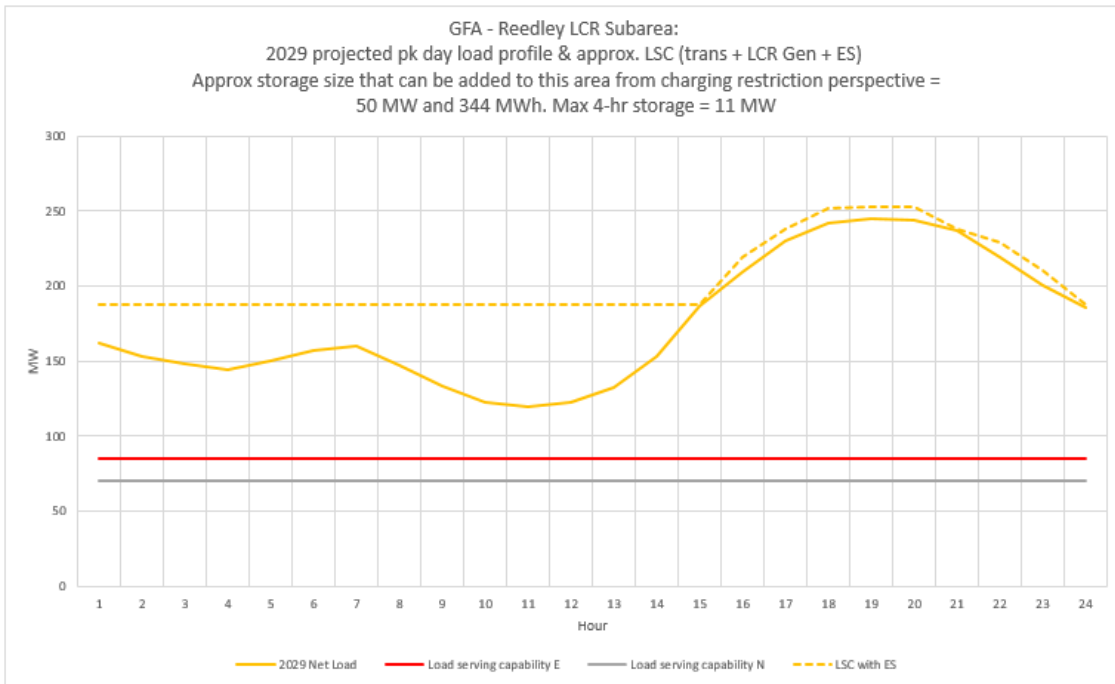
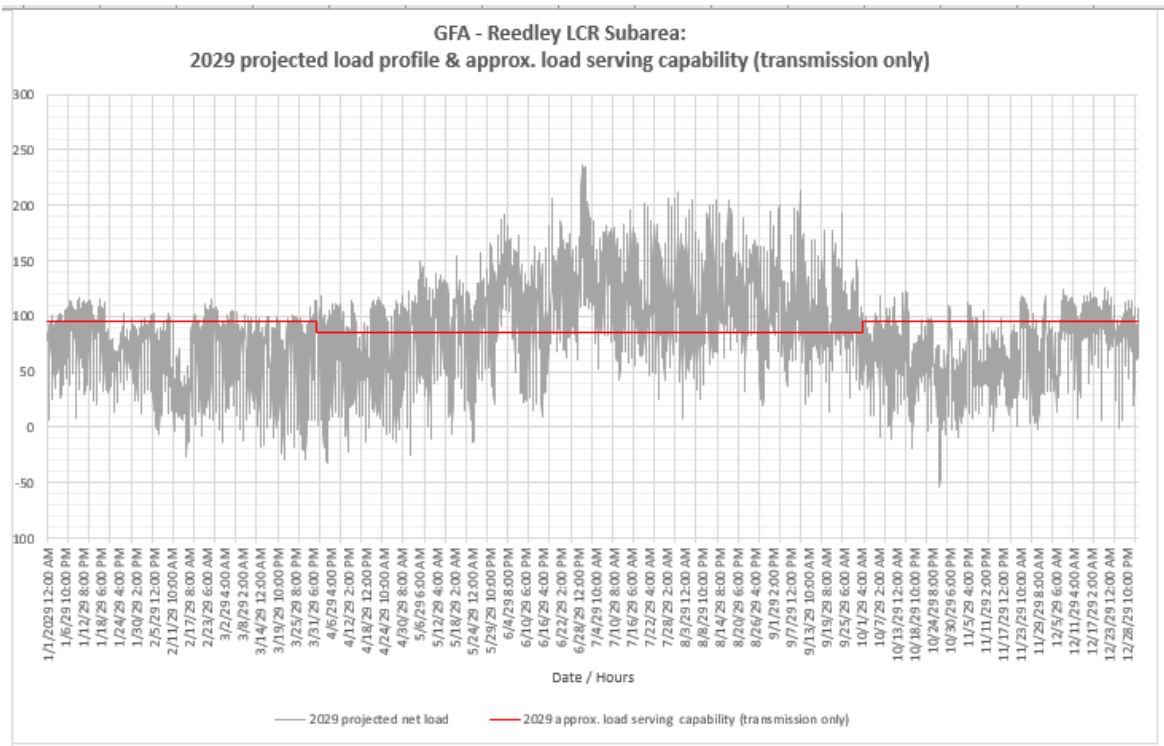

Figure 3.2-46 Reedley LCR Sub-area 2029 Forecast Hourly Profiles



3.2.6.5.4 Reedley LCR Sub-area Requirement

Table 3.2-41 identifies the sub-area requirements. The LCR Requirement for a Category P6 contingency is 165 MW including a 124 MW of deficiency.

Table 3.2-41 Reedley LCR Sub-area Requirements

Year	Limit	Category	Limiting Facility	Contingency	LCR (MW) (Deficiency)
2029	First Limit	P6	Kings River-Sanger-Reedley 115 kV with Wahtoke load online	McCall-Reedley 115 kV & Sanger-Reedley 115 kV	165 (124)

3.2.6.5.5 Effectiveness factors:

All units within the Reedley sub-area have the same effectiveness factor.

For most helpful procurement information please read procedure 2210Z Effectiveness Factors under 7430 posted at: <http://www.caiso.com/Documents/2210Z.pdf>

3.2.6.6 Panoche Sub-area

Panoche is a sub-area of the Fresno LCR area.

3.2.6.6.1 Panoche LCR Sub-area Diagram

Figure 3.2-47 Panoche LCR Sub-area

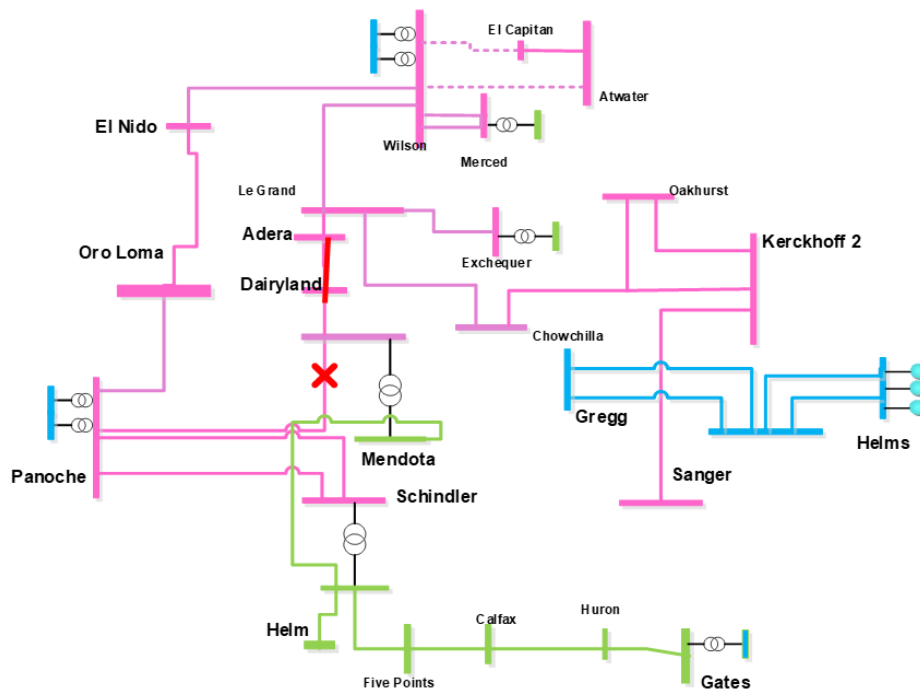

3.2.6.6.2 Panoche LCR Sub-area Load and Resources

Table 3.2-42 provides the forecast load and resources in Panoche LCR sub-area. The list of generators within the LCR sub-area are provided in Attachment A.

Table 3.2-42 Panoche LCR Sub-area 2029 Forecast Load and Resources

Load (MW)		Generation (MW)	Aug NQC	At Peak
Gross Load	504	Market/NetSeller	274	274
AAEE	-6	Battery	0	0
Behind the meter DG	-19	MUNI/QF	107	107
Net Load	479	Solar	43	0
Transmission Losses	15	Existing 20-minute Demand Response	0	0
Pumps	0	Mothballed	0	0
Load + Losses + Pumps	494	Total	424	381

3.2.6.6.3 Panoche LCR Sub-area Hourly Profiles

Figure 3.2-48 illustrates the forecast 2029 profile for the peak day for the Panoche LCR sub-area with the Category P6 normal and emergency load serving capabilities without local resources. The chart also includes an estimated amount of energy storage that can be added to this local area from charging restriction perspective. Figure 3.2-49 illustrates the forecast 2029 hourly profile for Panoche LCR sub-area with the Category P6 emergency load serving capability without local resources.

Figure 3.2-48 Panoche LCR Sub-area 2029 Peak Day Forecast Profiles

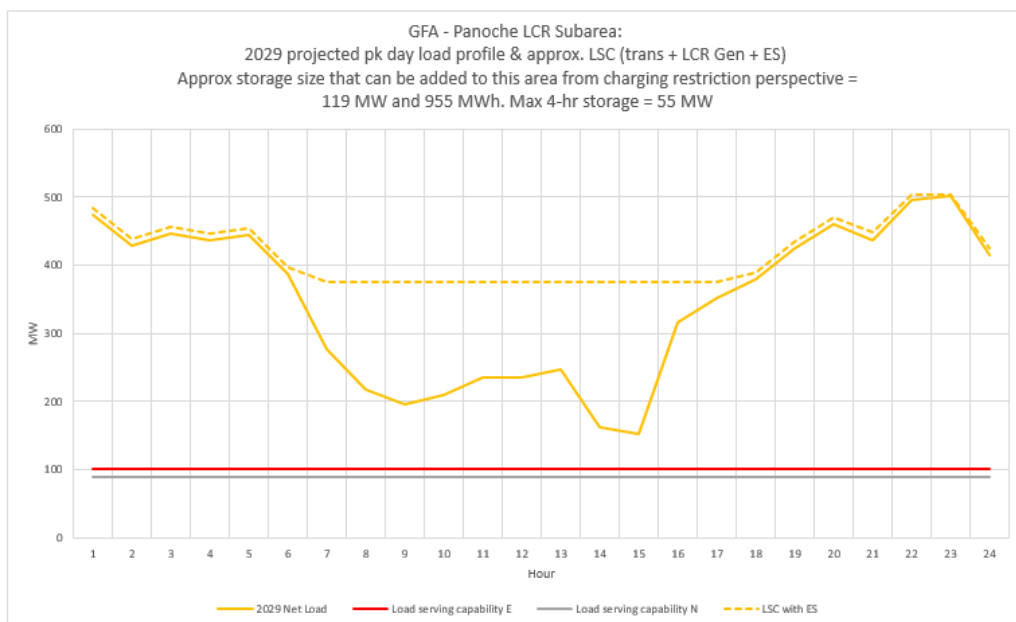
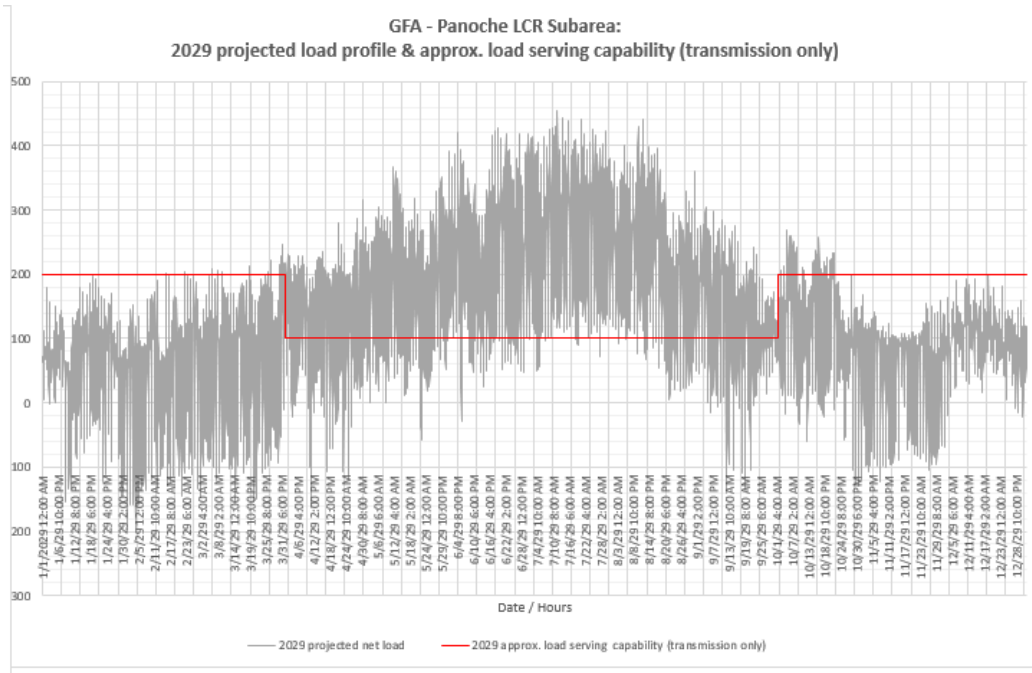

Figure 3.2-49 Panoche LCR Sub-area 2029 Forecast Hourly Profiles



3.2.6.6.4 Panoche LCR Sub-area Requirement

Table 3.2-43 identifies the sub-area LCR requirements. The LCR Requirement for a Category P6 contingency is 404 MW including a 23 MW deficiency at peak.

Table 3.2-43 Panoche LCR Sub-area Requirements

Year	Limit	Category	Limiting Facility	Contingency	LCR (MW) (Deficiency)
2029	First limit	P1	Dairyland-Adera Solar Junction 115 kV line	Panoche –Mendota 115 kV line	404 (23 Peak)

3.2.6.6.5 Effectiveness factors:

For other helpful procurement information please read procedure 2210Z Effectiveness Factors under 7430 posted at: <http://www.caiso.com/Documents/2210Z.pdf>

3.2.6.7 Wilson Sub-area

Wilson sub-area will be eliminated due to the addition of the New Wilson 230/115kV Bank #3 project.

3.2.6.8 Herndon Sub-area

Herndon is a sub-area of the Fresno LCR area.

3.2.6.8.1 Herndon LCR Sub-area Diagram

Figure 3.2-50 Herndon LCR Sub-area

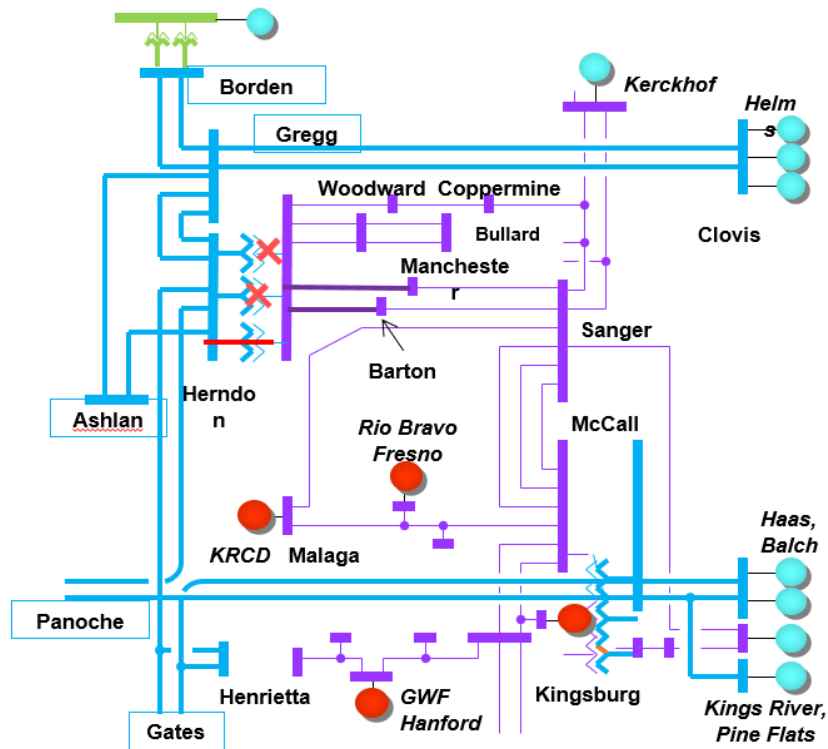

3.2.6.8.2 Herndon LCR Sub-area Load and Resources

Table 3.2-44 provides the forecast load and resources in Herndon LCR sub-area. The list of generators within the LCR sub-area are provided in Attachment A.

Table 3.2-44 Herndon LCR Sub-area 2029 Forecast Load and Resources

Load (MW)		Generation (MW)	Aug NQC	At Peak
Gross Load	1775	Market/NetSeller	864	864
AAEE	-28	Battery	16	16
Behind the meter DG	-71	MUNI/QF	121	121
Net Load	1676	Solar	31	0
Transmission Losses	38	Existing 20-minute Demand Response	0	0
Pumps	0	Mothballed	0	0
Load + Losses + Pumps	1714	Total	1032	1001

3.2.6.8.3 Herndon LCR Sub-area Hourly Profiles

Figure 3.2-51 illustrates the forecast 2029 profile for the peak day for the Herndon LCR sub-area with the Category P6 normal and emergency load serving capabilities without local resources. The chart also includes an estimated amount of energy storage that can be added to this local area from charging restriction perspective. Figure 3.2-52 illustrates the forecast 2029 hourly profile for Herndon LCR sub-area with the Category P6 emergency load serving capability without local resources.

Figure 3.2-51 Herndon LCR Sub-area 2029 Peak Day Forecast Profiles

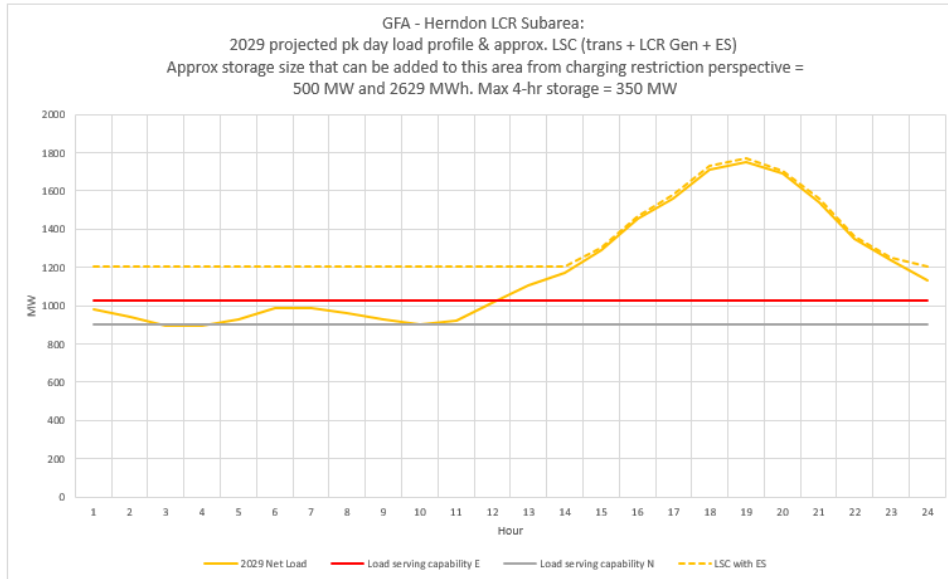
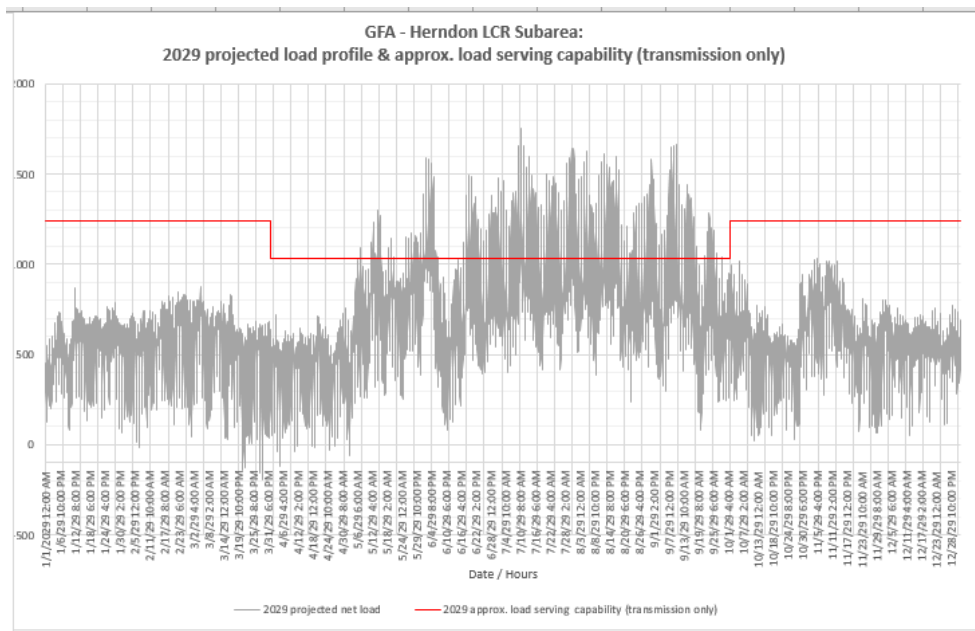

Figure 3.2-52 Herndon LCR Sub-area 2029 Forecast Hourly Profiles



3.2.6.8.4 Herndon LCR Sub-area Requirement

Table 3.2-45 identifies the sub-area LCR requirements. The LCR Requirement for a Category P6 contingency is 803 MW.

Table 3.2-45 Herndon LCR Sub-area Requirements

Year	Limit	Category	Limiting Facility	Contingency	LCR (MW) (Deficiency)
2029	First limit	P6	Herndon #3 230/115kV Transformer Bank	Herndon- 230/115kV Bank 1 and Herndon 230/115kV Bank 2	803

3.2.6.8.5 Effectiveness factors:

For other helpful procurement information please read procedure 2210Z Effectiveness Factors under 7430 posted at: <http://www.caiso.com/Documents/2210Z.pdf>

3.2.6.9 Fresno Overall area

3.2.6.9.1 Fresno LCR area Diagram

Figure 3.2-53 Fresno LCR area

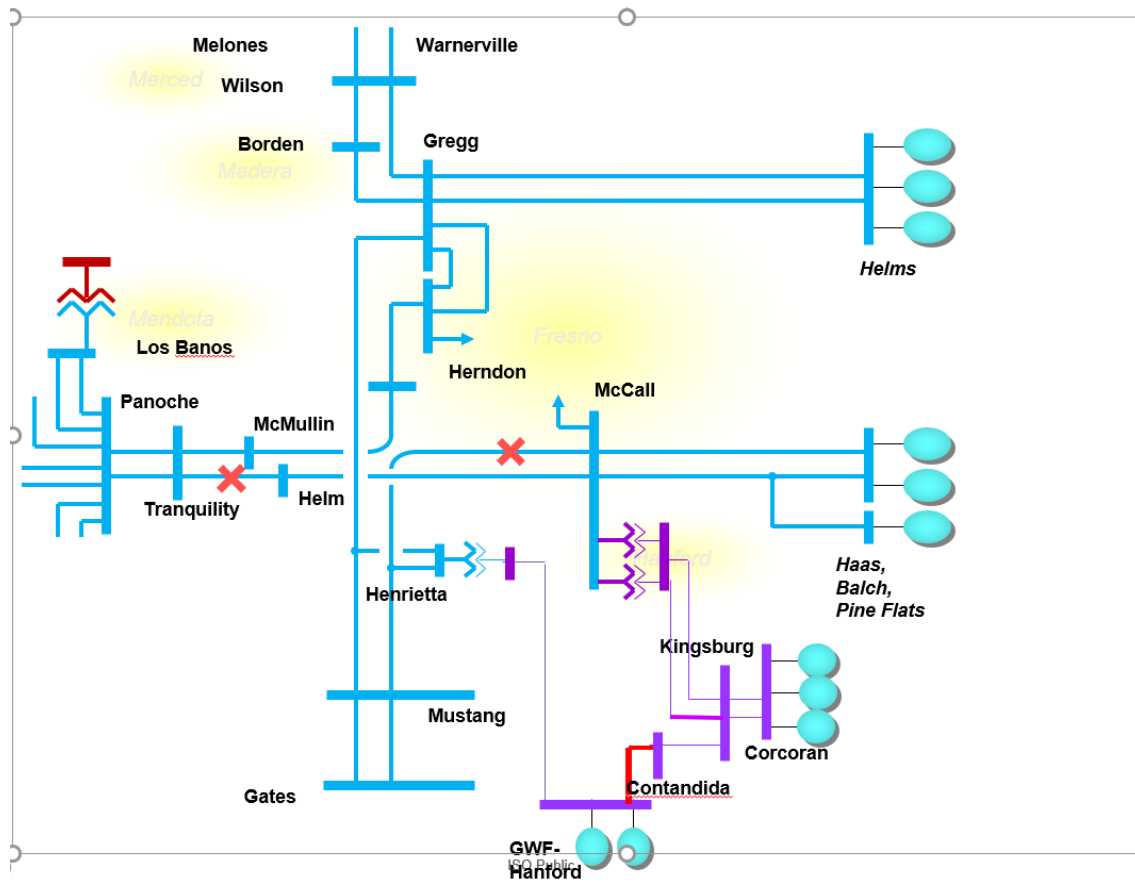

3.2.6.9.2 Fresno Overall LCR area Load and Resources

Table 3.2-35 provides the forecast load and resources in Fresno LCR area. The list of generators within the LCR area are provided in Attachment A.

3.2.6.9.3 Fresno Overall LCR area Hourly Profiles

Figure 3.2-54 illustrates the forecasted 2029 profile for the peak day for the Overall LCR area with the Category P6 normal and emergency load serving capabilities without local resources. The chart also includes an estimated amount of energy storage that can be added to this local area from charging restriction perspective. Figure 3.2-55 illustrates the forecasted 2029 hourly profile for Overall LCR area with the Category P6 emergency load serving capability without local resources.

Figure 3.2-54 Fresno LCR Area 2029 Peak Day Forecast Profiles

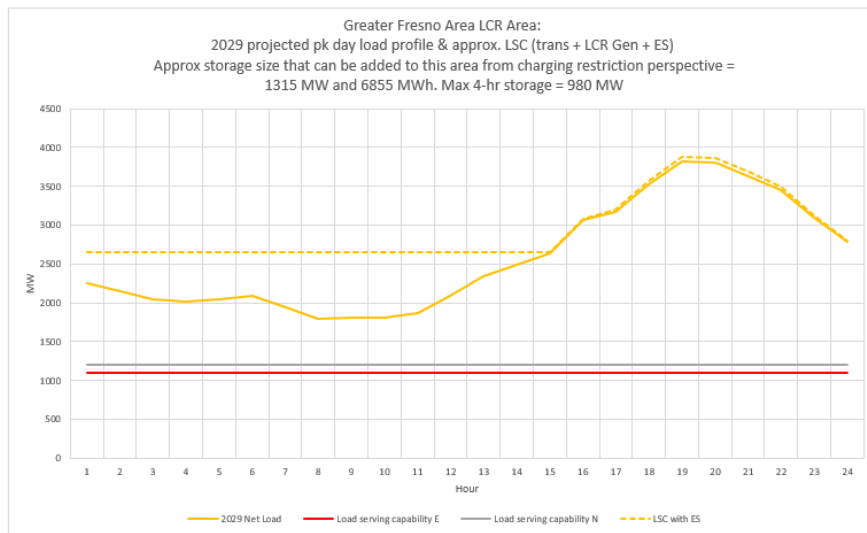
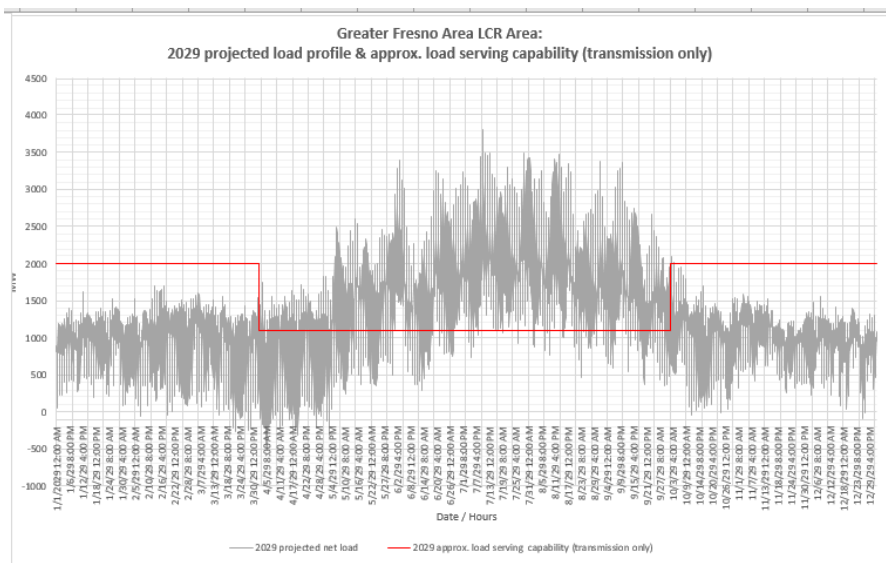

Figure 3.2-55 Fresno LCR Area 2029 Forecast Hourly Profiles



3.2.6.9.4 Fresno Overall LCR Area Requirement

Table 3.2-46 identifies the area LCR requirements. The LCR requirement Category P6 contingency is 2512 MW.

Table 3.2-46 Fresno Overall LCR Area Requirements

Year	Limit	Category	Limiting Facility	Contingency	LCR (MW) (Deficiency)
2029	First limit	P6	Kingsburg-Contadina 115 kV line	Mc Call-Helm 230 kV Line and Henrietta Tap-Mustang 230 kV line	2512

3.2.6.9.5 Effectiveness factors:

For most helpful procurement information please read procedure 2210Z Effectiveness Factors under 7430 posted at: <http://www.caiso.com/Documents/2210Z.pdf>

3.2.6.9.6 Changes compared to last year’s study

Compared with 2028 the load forecast increased by 136 MW and the LCR has reduced by 216 MW, mostly due to new transmission projects.

3.2.7 Kern Area

3.2.7.1 Area Definition:

The transmission facilities coming into the Kern PP sub-area are:

- Midway-Kern PP #1 230 kV Line
- Midway-Kern PP #2 230 kV Line
- Midway-Kern PP #3 230 kV Line
- Midway-Kern PP #4 230 kV Line
- Famoso-Lerdo 115 kV Line (Seasonal Open)
- Adobe Switching Station #1 115 kV Tap (Normal Open)
- Wasco-Famoso 70 kV Line (Seasonal Open)
- Kern-Magunden 70 kV Line (Seasonal Open)
- Copus-Old River 70 kV Line (Seasonal Open)
- Copus-Old River 70 kV Line (Normal Open)

The substations that delineate the Kern-PP sub-area are:

- Midway 230 kV is out and Bakersfield 230 kV is in

- Midway 230 kV is out and Kern PP 230 kV is in
- Midway 230 kV is out and Kern PP 230 kV is in
- Midway 230 kV is out and Kern PP 230 kV is in
- Famoso 115 kV is out and Cawelo 115 kV is in
- Adobe Switching Station 115 kV is out and Wheeler Ridge Junction 115 kV is in
- Wasco 70 kV is out and Mc Farland 70 kV is in
- Magunden 70 kV is out and Bakersfield Junction 70 kV is in
- Copus 70 kV is out and South Kern Solar 70 kV is in
- Lakeview 70 kV is out and San Emidio Junction 70 kV is in

3.2.7.1.1 Kern LCR Area Diagram

Figure 3.2-56 Kern LCR Area

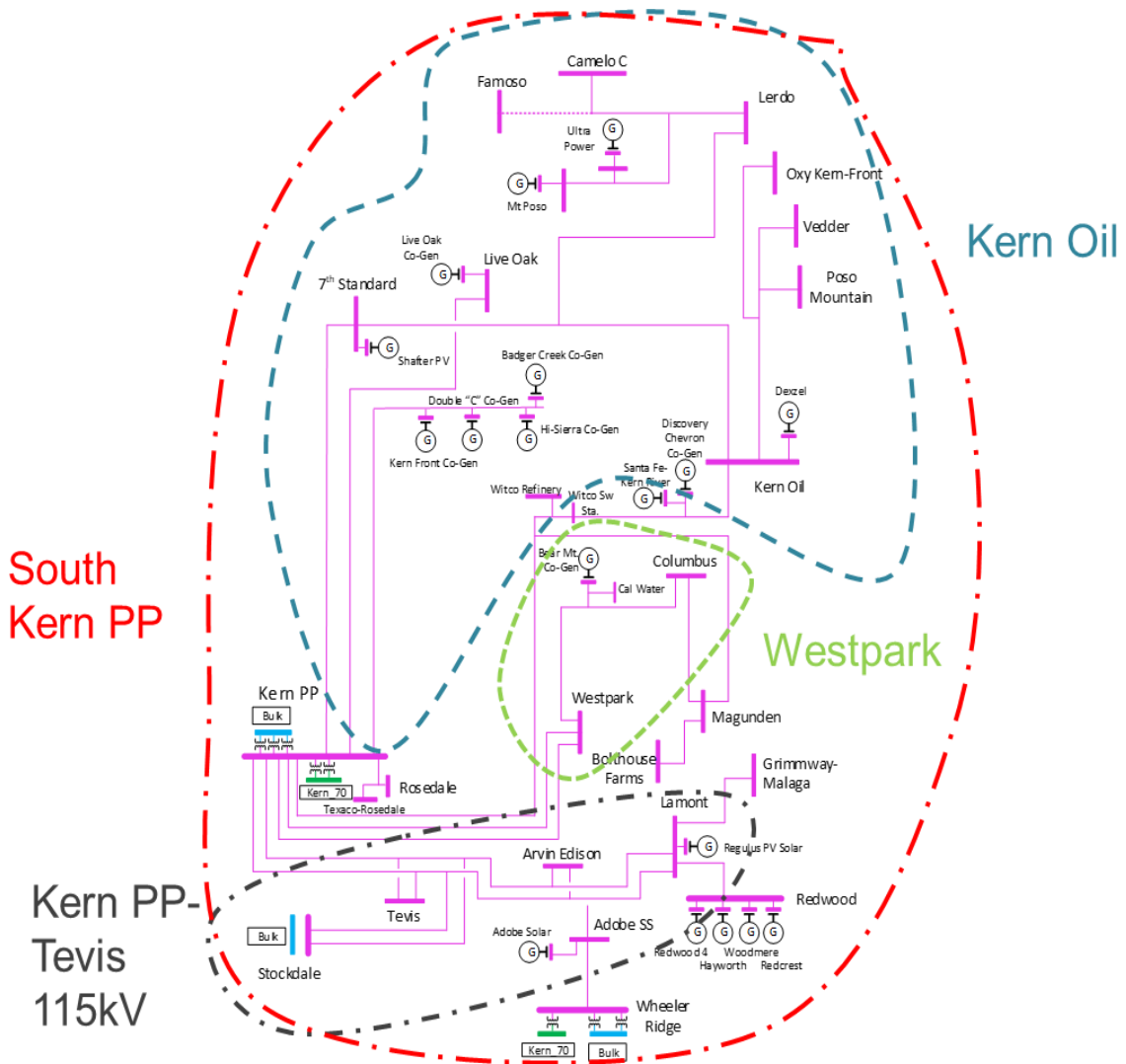

3.2.7.1.2 Kern LCR Area Load and Resources

Table 3.2-47 provides the forecast load and resources in Kern LCR area. The list of generators within the LCR area are provided in Attachment A.

In year 2029 the estimated time of local area peak is 19:20 PM.

At the local area peak time the estimated, ISO metered, solar output is 0.00%.

If required, all non-solar technology type resources are dispatched at NQC.

Table 3.2-47 Kern LCR Area 2029 Forecast Load and Resources

Load (MW)		Generation (MW)	Aug NQC	At Peak
Gross Load	913	Market/Net Seller	368	368
AAEE	-19	Battery	20	20
Behind the meter DG	0	MUNI/QF	9	9
Net Load	894	Solar	43	0
Transmission Losses	8	Existing 20-minute Demand Response	9	9
Pumps	0	Mothballed	0	0
Load + Losses + Pumps	902	Total	449	406

3.2.7.1.3 Approved transmission projects modeled

1. Midway-Temblor 115 kV Line Reconductor & Voltage Support (Oct 2027)
2. Bakersfield Nos. 1 and 2 230 kV Tap Lines Reconductoring (August 2027)
3. Kern PP 115 kV Area Reinforcement (July 2027)

3.2.7.2 Kern Power – Tevis 115 kV Sub-area

Kern Power –Tevis 115 kV is a sub-area of the Kern LCR area.

3.2.7.2.1 Kern Power – Tevis 115 kV LCR Sub-area Diagram

Please see Figure 3.2-56 for Kern Power – Tevis 115 kV sub-area diagram

3.2.7.2.2 Kern Power – Tevis 115 kV LCR Sub-area Requirement

No LCR need was identified for the Kern Power-Tevis sub-area.

3.2.7.3 Westpark Sub-area

Westpark is a sub-area of the Kern LCR area.

3.2.7.3.1 Westpark LCR Sub-area Diagram

Please see Figure 3.2-56 for Westpark sub-area diagram.

3.2.7.3.2 Westpark LCR Sub-area Load and Resources

Table 3.2-48 provides the forecast load and resources in Westpark LCR sub-area. The list of generators within the LCR sub-area are provided in Attachment A.

Table 3.2-48 Westpark LCR Sub-area 2029 Forecast Load and Resources

Load (MW)		Generation (MW)	Aug NQC	At Peak
Gross Load	126	Market, Net Seller	49	49
AAEE	-3	MUNI	0	0
Behind the meter DG	0	QF	0	0
Net Load	123	LTPP Preferred Resources	0	0
Transmission Losses	0	Existing 20-minute Demand Response	0	0
Pumps	0	Mothballed	0	0
Load + Losses + Pumps	123	Total	49	49

3.2.7.3.3 Westpark LCR Sub-area Hourly Profiles

Figure 3.2-57 illustrates the forecast 2029 profile for the summer peak, winter peak and spring off-peak days for the Westpark LCR sub-area with the Category P7 contingency transmission capability without resources. Figure 3.2-58 illustrates the forecast 2029 hourly profile for Westpark LCR sub-area with the Category P7 contingency transmission capability without resources.

Figure 3.2-57 Westpark LCR Sub-area 2029 Peak Day Forecast Profiles

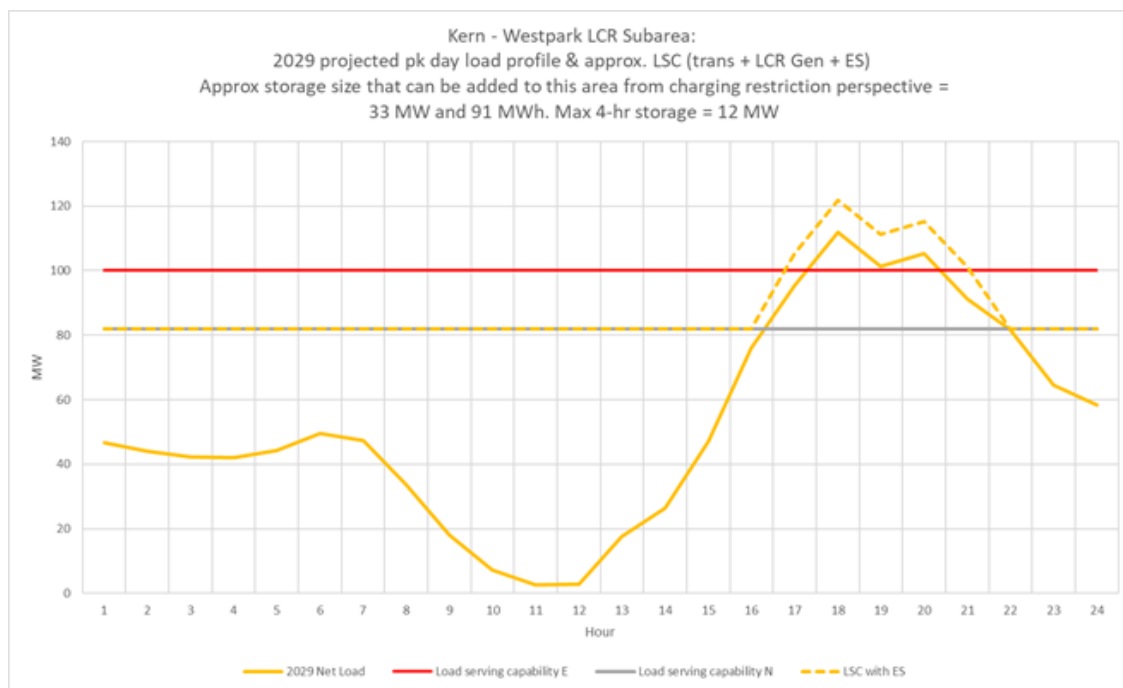
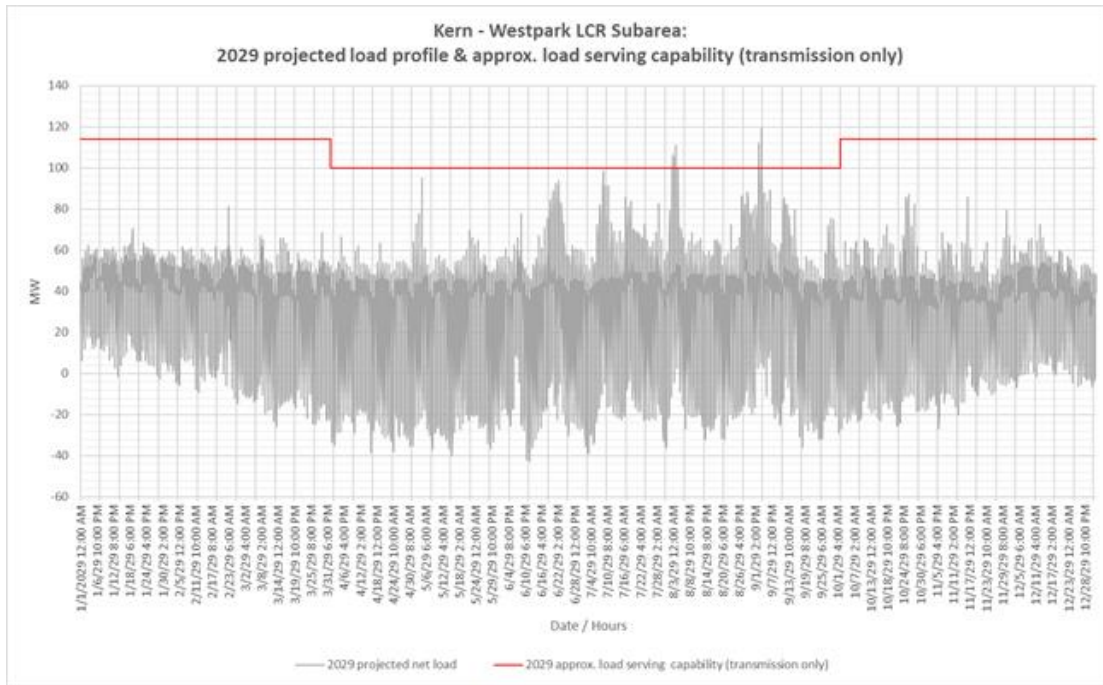

Figure 3.2-58 Westpark LCR Sub-area 2029 Forecast Hourly Profiles



3.2.7.3.4 Westpark LCR Sub-area Requirement

Table 3.2-49 identifies the sub-area LCR requirements. The LCR requirement for Category P7 contingency is 33 MW.

Table 3.2-49 Westpark LCR Sub-area Requirements

Year	Category	Limiting Facility	Contingency	LCR (MW) (Deficiency)
2029	P7	Magunden–Magunden Jct. 115 kV Line	Kern PP-Westpark No. 1 & 2 115 kV Lines	33

3.2.7.3.5 Effectiveness factors:

All units within the Westpark sub-area have the same effectiveness factor.

For most helpful procurement information please read procedure 2210Z Effectiveness Factors under 7450 posted at: <http://www.caiso.com/Documents/2210Z.pdf>

3.2.7.4 Kern Oil Sub-area

Kern Oil is a sub-area of the Kern LCR area.

3.2.7.4.1 Kern Oil LCR Sub-area Diagram

Please see Figure 3.2-56 for Kern Oil sub-area diagram.

3.2.7.4.2 Kern Oil LCR Sub-area Load and Resources

Table 3.2-50 provides the forecast load and resources in Kern Oil LCR sub-area. The list of generators within the LCR sub-area are provided in Attachment A.

Table 3.2-50 Kern Oil LCR Sub-area 2029 Forecast Load and Resources

Load (MW)		Generation (MW)	Aug NQC	At Peak
Gross Load	304	Market/NetSeller	110	110
AAEE	-4	Battery	0	0
Behind the meter DG	0	MUNI/QF	10	10
Net Load	300	Solar	3	0
Transmission Losses	1	Existing 20-minute Demand Response	0	0
Pumps	0	Mothballed	0	0
Load + Losses + Pumps	301	Total	123	120

3.2.7.4.3 Kern Oil LCR Sub-area Hourly Profiles

Figure 3.2-59 illustrates the forecast 2029 profile for the summer peak, winter peak and spring off-peak days for the Kern Oil LCR sub-area with the Category P6 contingency transmission capability without resources. Figure 3.2-60 illustrates the forecast 2029 hourly profile for Kern Oil LCR sub-area with the Category P6 contingency transmission capability without resources.

Figure 3.2-59 Kern Oil LCR Sub-area 2029 Peak Day Forecast Profiles

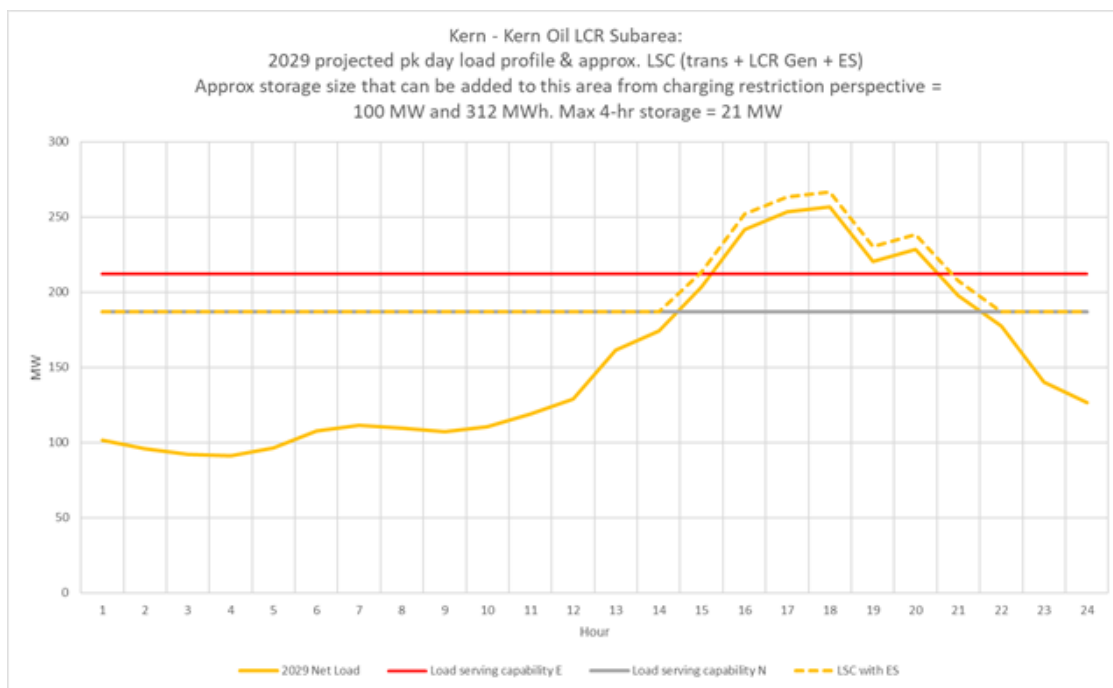
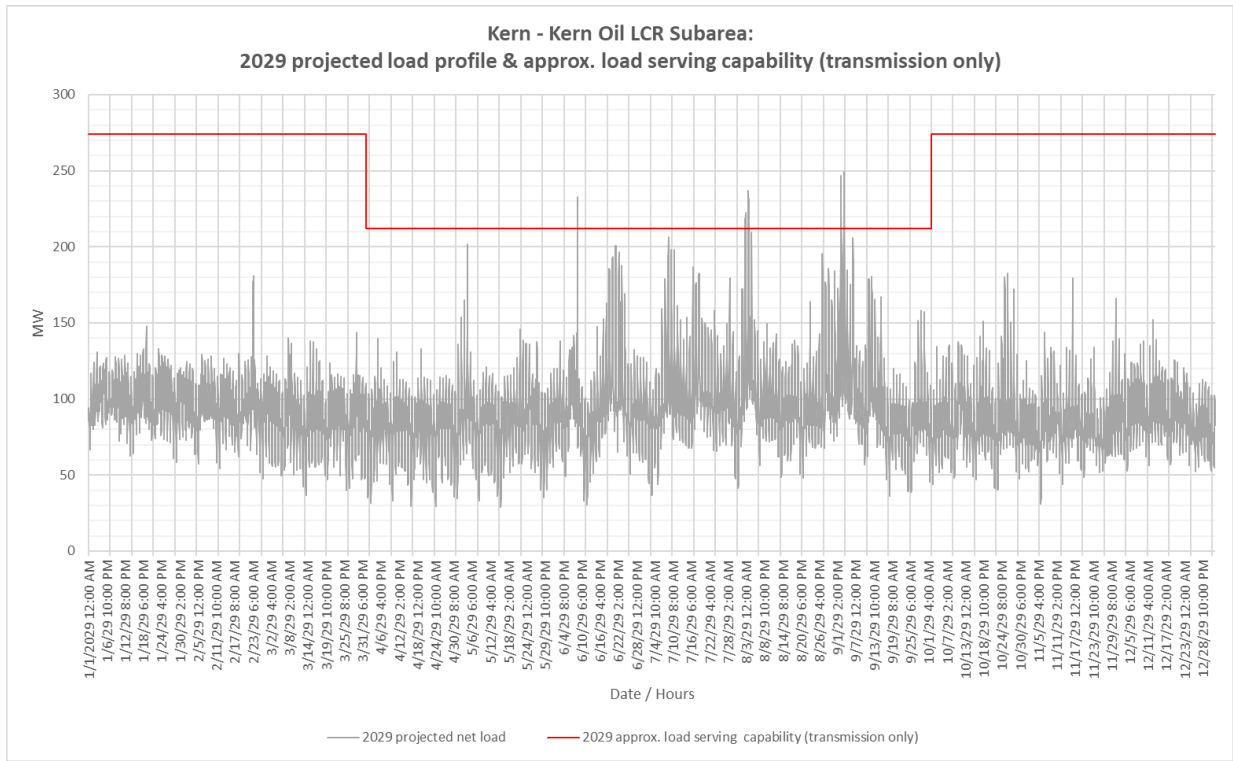

Figure 3.2-60 Kern Oil LCR Sub-area 2029 Forecast Hourly Profiles



3.2.7.4.4 Kern Oil LCR Sub-area Requirement

Table 3.2-51 identifies the sub-area LCR requirements. The LCR requirement for Category P6 contingency LCR requirement is 100 MW.

Table 3.2-51 Kern Oil LCR Sub-area Requirements

Year	Category	Limiting Facility	Contingency-	LCR (MW) (Deficiency)
2029	P6	Kern Oil - Kern Water 115 kV Line	Kern PP-7th Standard 115 kV lines & Kern PP-Live Oak 115 kV Line	100

3.2.7.4.5 Effectiveness factors:

All units within the Kern Oil sub-area have the same effectiveness factor.

For most helpful procurement information please read procedure 2210Z Effectiveness Factors under 7450 posted at: <http://www.caiso.com/Documents/2210Z.pdf>

3.2.7.5 South Kern PP Sub-area

South Kern PP is sub-area of the Kern LCR area.

3.2.7.5.1 South Kern PP LCR Sub-area Diagram

Figure 3.2-61 South Kern PP LCR Sub-area

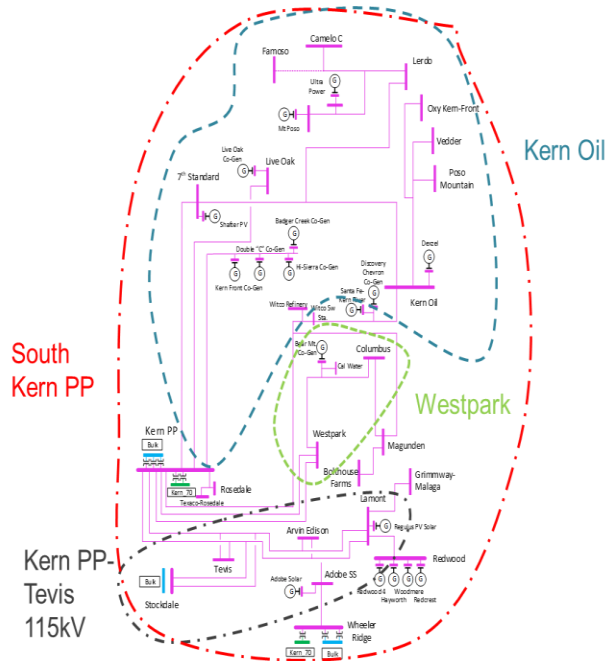

Refer to Table 3.2-47 Kern area Load and Resources table.

3.2.7.5.3 South Kern PP LCR Sub-area Hourly Profiles

Figure 3.2-62 illustrates the forecast 2029 profile for the summer peak, winter peak and spring off-peak days for the South Kern PP LCR sub-area with the Category P6 contingency transmission capability without resources. Figure 3.2-63 illustrates the forecast 2029 hourly profile for South Kern PP LCR sub-area with the Category P6 contingency transmission capability without resources.

Figure 3.2-62 South Kern PP LCR Sub-area 2029 Peak Day Forecast Profiles

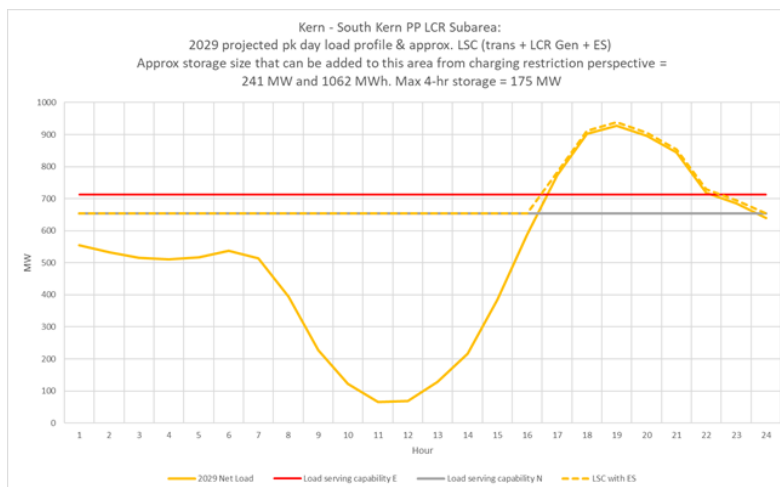
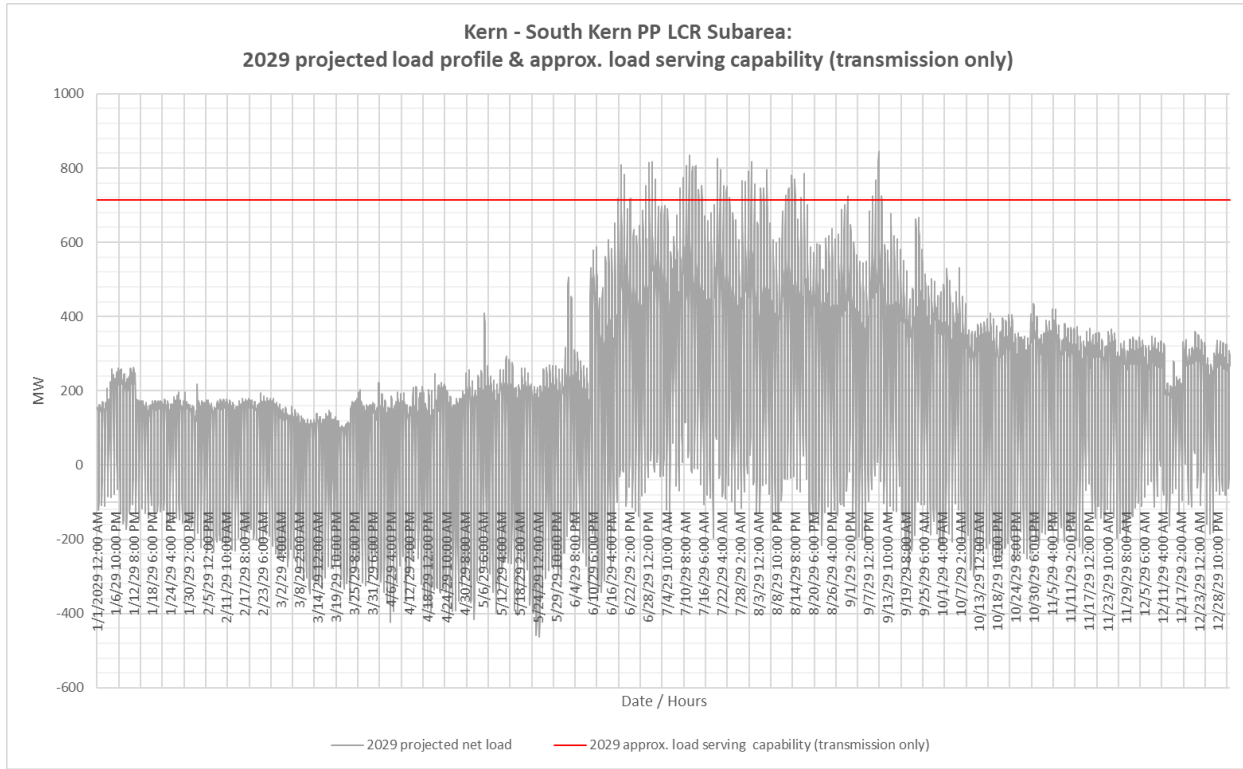

Figure 3.2-63 South Kern Overall LCR Area 2029 Forecast Hourly Profiles



3.2.7.5.4 South Kern PP LCR Sub-area Requirement

Table 3.2-52 identifies the sub-area LCR requirements. The LCR requirement for Category P6 contingency is 241 MW.

Table 3.2-52 South Kern PP LCR Sub-area Requirements

Year	Category	Limiting Facility	Contingency	LCR (MW) (Deficiency)
2029	P6	Kern 230/115 kV T/F # 5	Kern 230/115 kV T/F # 3 & Kern 230/115 kV T/F # 4	241

3.2.7.5.5 Effectiveness factors:

For most helpful procurement information please read procedure 2210Z Effectiveness Factors under 7450 posted at: <http://www.caiso.com/Documents/2210Z.pdf>

3.2.7.6 Kern Area Overall Requirements

3.2.7.6.1 Kern LCR Area Overall Requirement

Table 3.2-53 identifies the limiting facility and contingency that establishes the Kern Area 2029 LCR requirements. The LCR requirement for Category P6 contingency the LCR requirement is 241 MW.

Table 3.2-53 Kern Overall LCR area Requirements

Year	Limit	Category	Limiting Facility	Contingency	LCR (MW) (Deficiency)
2029	N/A	P6	Aggregate of Sub-areas.		241

3.2.7.6.2 Kern Overall LCR Area Hourly Profile

Refer to South Kern PP LCR area profiles.

3.2.7.6.3 Changes compared to last year’s study

Compared with 2028, the load forecast has decreased by 64 MW and the overall Kern resource requirements has decreased by 190 MW plus an additional reduction in deficiency of 133 MW mostly due to load decrease and due to the Kern 115 kV Reinforcement Project.

3.2.8 Big Creek/Ventura Area

3.2.8.1 Area Definition:

The transmission tie lines into the Big Creek/Ventura Area are:

- Antelope #1 500/230 kV Transformer
- Antelope #2 500/230 kV Transformer
- Sylmar - Pardee 230 kV #1 and #2 Lines
- Vincent - Pardee 230 kV #2 Line
- Vincent - Santa Clara 230 kV Line

The substations that delineate the Big Creek/Ventura Area are:

- Antelope 500 kV is out Antelope 230 kV is in
- Antelope 500 kV is out Antelope 230 kV is in
- Sylmar is out Pardee is in
- Vincent is out Pardee is in
- Vincent is out Santa Clara is in

3.2.8.1.1 Big Creek/Ventura LCR Area Diagram

Figure 3.2-64 Big Creek/Ventura LCR Area

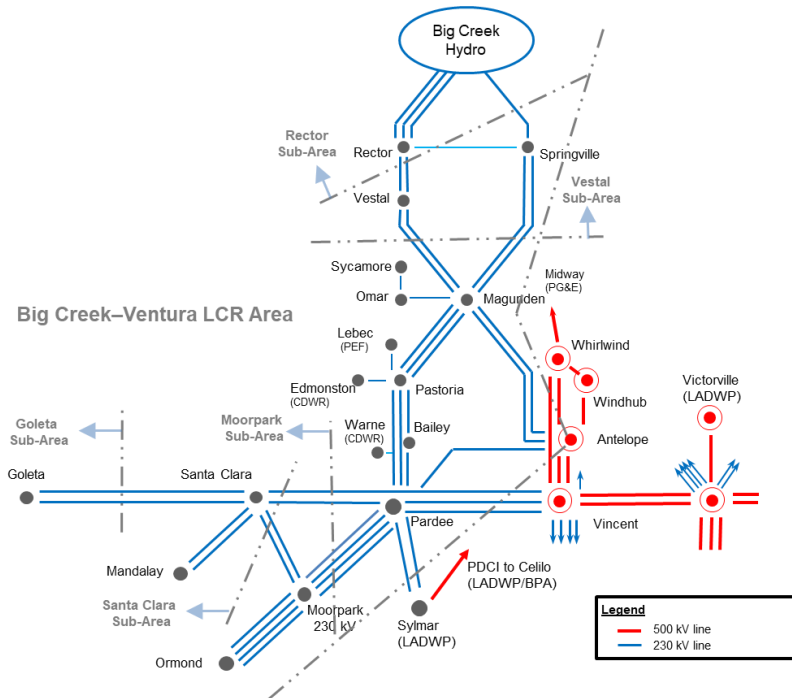

3.2.8.1.2 Big Creek/Ventura LCR Area Load and Resources

Table 3.2-54 provides the forecast load and resources in the Big Creek/Ventura LCR area in 2029. The list of generators within the LCR area are provided in Attachment A.

In year 2029 the estimated time of local area peak is 5:00 PM (PST).

At the local area peak time the estimated, ISO-metered solar output is 24%.

If required, all non-solar technology type resources are dispatched at NQC.

Table 3.2-54 Big Creek/Ventura LCR Area 2028 Forecast Load and Resources

Load (MW)		Generation (MW)	Aug NQC	At Peak
Gross Load	4791	Market/Net Seller	2554	2554
AAEE	-93	Battery	1085	1085
Behind the meter DG	0	MUNI/QF	399	399
Net Load	4698	Solar	249	249
Transmission Losses	96	Demand Response	63	63
Pumps	390	Mothballed	0	0
Load + Losses + Pumps	5184	Total	4350	4350

3.2.8.1.3 Approved transmission projects modeled:

Sylmar–Pardee 230 kV Rating Increase Project (ISD October 2027)

3.2.8.2 Rector Sub-area

LCR need is satisfied by the need in the larger Vestal sub-area.

3.2.8.3 Vestal Sub-area

Vestal is a sub-area of the Big Creek/Ventura LCR area.

3.2.8.3.1 Vestal LCR Sub-area Diagram

Figure 3.2-65 Vestal LCR Sub-area

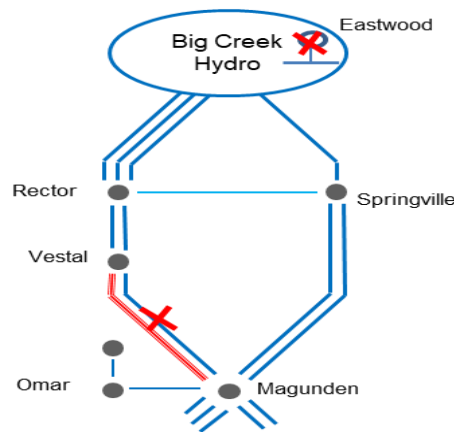

3.2.8.3.2 Vestal LCR Sub-area Load and Resources

Table 3.2-55 provides the forecast load and resources in Vestal LCR sub-area in 2029. The list of generators within the LCR sub-area are provided in Attachment A.

Table 3.2-55 Vestal LCR Sub-area 2029 Forecast Load and Resources

Load (MW)		Generation (MW)	Aug NQC	At Peak
Gross Load	1434	Market/Net Seller	954	954
AAEE	-30	Battery	269	269
Behind the meter DG	N/A	MUNI/QF	0	0
Net Load	1404	Solar	59	59
Transmission Losses	24	Demand Response	41	41
Pumps	0	Mothballed	0	0
Load + Losses + Pumps	1428	Total	1323	1323

3.2.8.3.3 Vestal LCR Sub-area Hourly Profiles

Figure 3.2-66 illustrates the forecast 2029 annual load profile in the Vestal LCR sub-area with the Category P3 normal and emergency load serving capabilities without local capacity resources. Figure 3.2-67 provides the load shape for the peak load day, estimated energy storage maximum capacity and energy based on area maximum charging capability under the most critical contingency as well as estimated four-hour capacity amount.

Figure 3.2-66 Vestal LCR Sub-area 2029 Annual Load Profile with Estimated Transmission Only Load Serving Capability

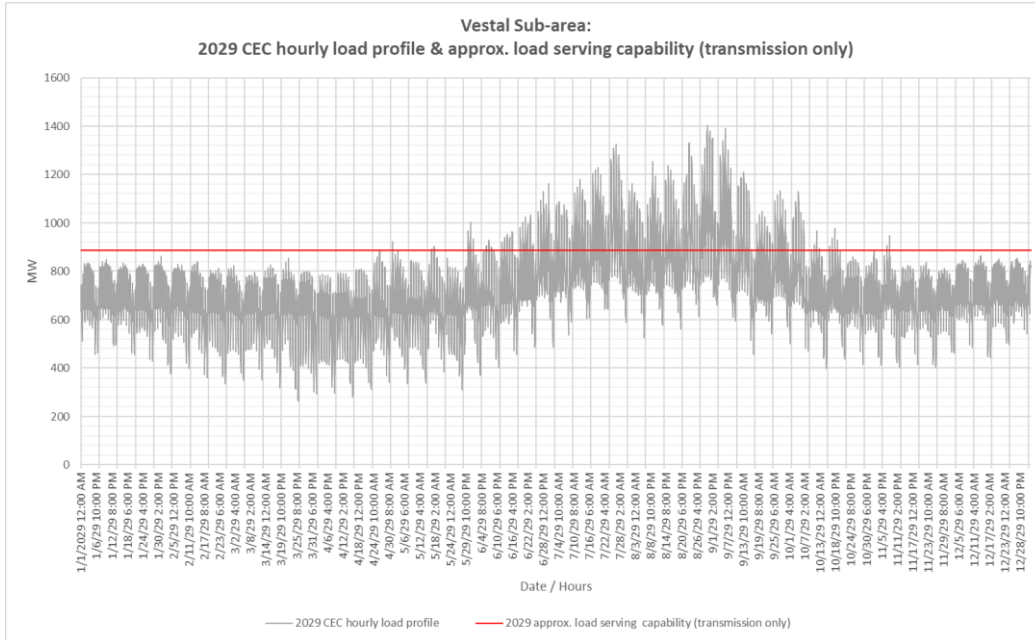
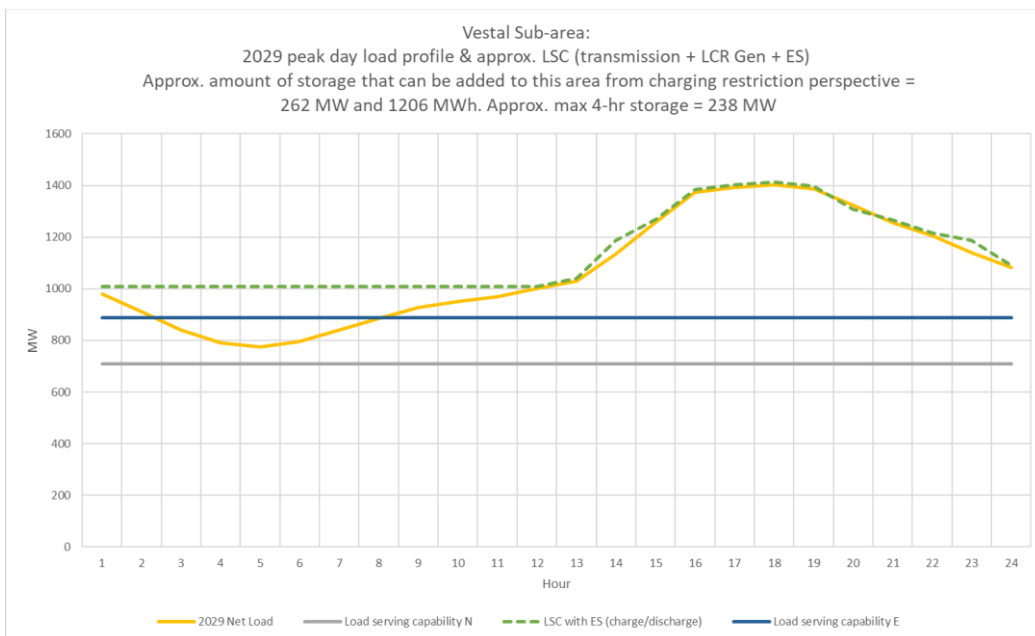

Figure 3.2-67 Vestal LCR Sub-area 2029 Load Shape and Estimated Maximum Energy Storage Capacity and Energy Based on Charging Capability Under Critical Contingency



3.2.8.3.4 Vestal LCR Sub-area Requirement

Table 3.2-56 identifies the sub-area LCR requirements. The 2029 LCR requirement for the Category P3 contingency is 517 MW.

Table 3.2-56 Vestal LCR Sub-area Requirements

Year	Category	Limiting Facility	Contingency	LCR (MW) (Deficiency)
2029	P3	Magunden–Vestal #1 230 kV line	Magunden–Vestal #2 230 kV line with Eastwood out of service	517

3.2.8.3.5 Effectiveness factors:

For helpful procurement information please read procedure 2210Z Effectiveness Factors under 7500 posted at: <http://www.caiso.com/Documents/2210Z.pdf>

3.2.8.4 Goleta Sub-area

Goleta is a sub-area of the Big Creek/Ventura LCR area.

The LCR need is satisfied by the need in the larger Santa Clara sub-area.

3.2.8.5 Santa Clara Sub-area

Santa Clara is a sub-area of the Big Creek/Ventura LCR area.

3.2.8.5.1 Santa Clara LCR Sub-area Diagram

Figure 3.2-68 Santa Clara LCR Sub-area

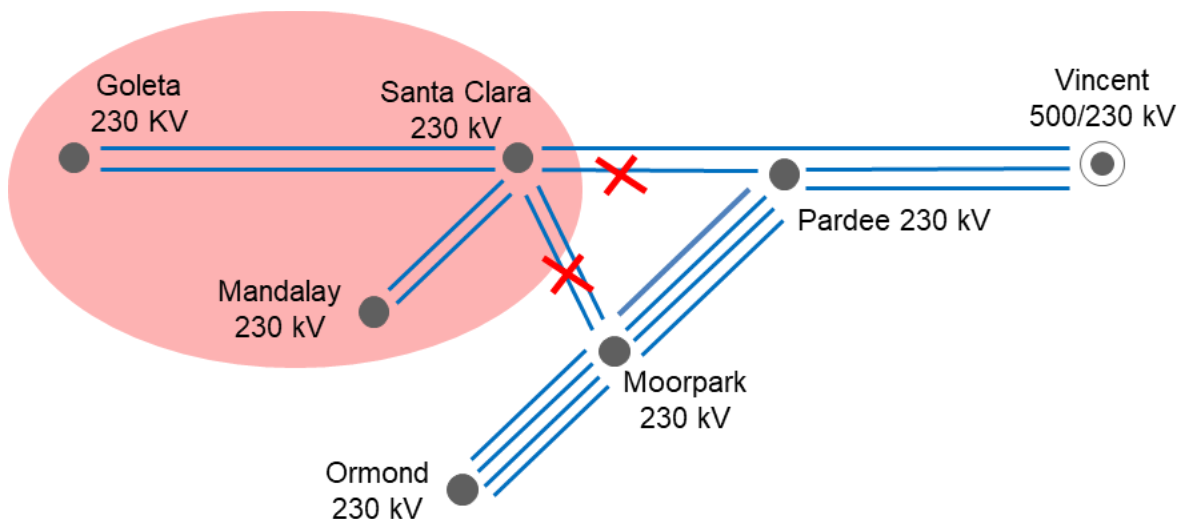

3.2.8.5.2 Santa Clara LCR Sub-area Load and Resources

Table 3.2-57 provides the forecast load and resources in Santa Clara LCR sub-area. The list of generators within the LCR sub-area are provided in Attachment A.

Table 3.2-57 Santa Clara LCR Sub-area 2029 Forecast Load and Resources

Load (MW)		Generation (MW)	Aug NQC	At Peak
Gross Load	904	Market/Net Seller	170	170
AEE	-18	Battery	221	221
Behind the meter DG	N/A	MUNI/QF	87	87
Net Load	886	Solar	0	0
Transmission Losses	5	Demand Response	7	7
Pumps	0	Mothballed	0	0
Load + Losses + Pumps	891	Total	485	485

3.2.8.5.3 Santa Clara LCR Sub-area Hourly Profiles

Figure 3.2-69 illustrates the forecast 2029 annual load profile in the Santa Clara LCR sub-area with the Category P1/P7 voltage stability related load serving capability without local capacity resources. Figure 3.2-70 provides the load shape for the peak load day, estimated energy storage maximum capacity and energy based on area maximum charging capability under the most critical contingency as well as estimated four-hour capacity amount.

Figure 3.2-69 Santa Clara LCR Sub-area 2029 Annual Load Profile with Estimated Transmission Only Load Serving Capability

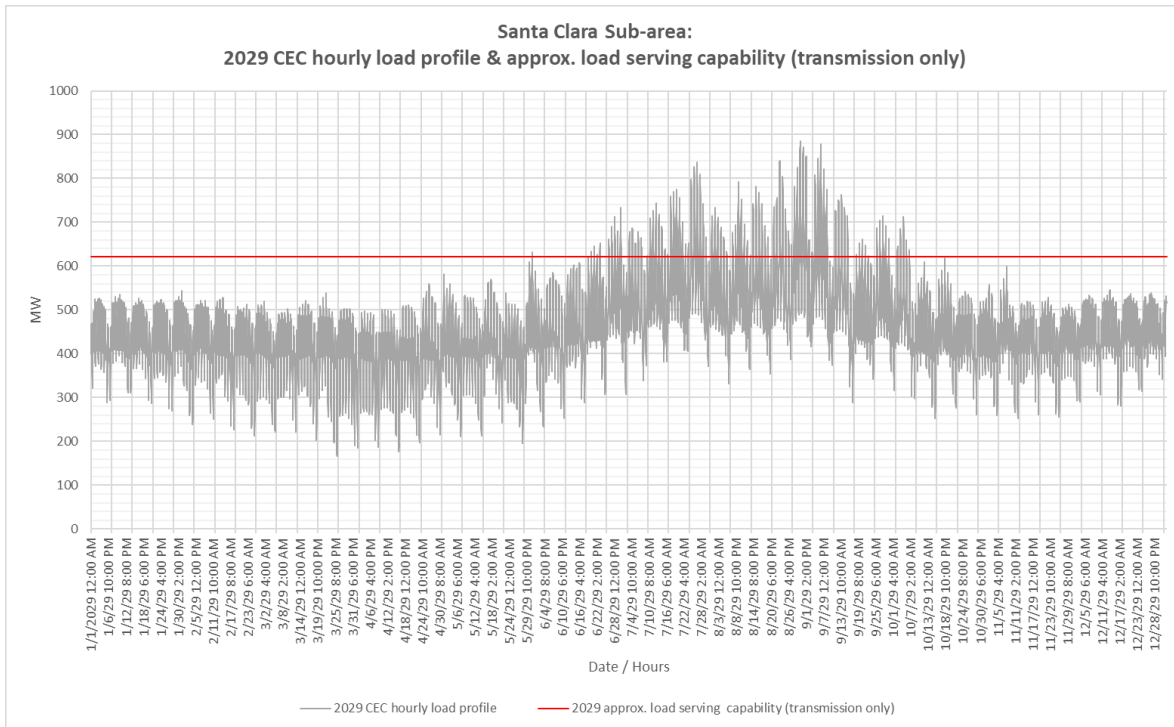
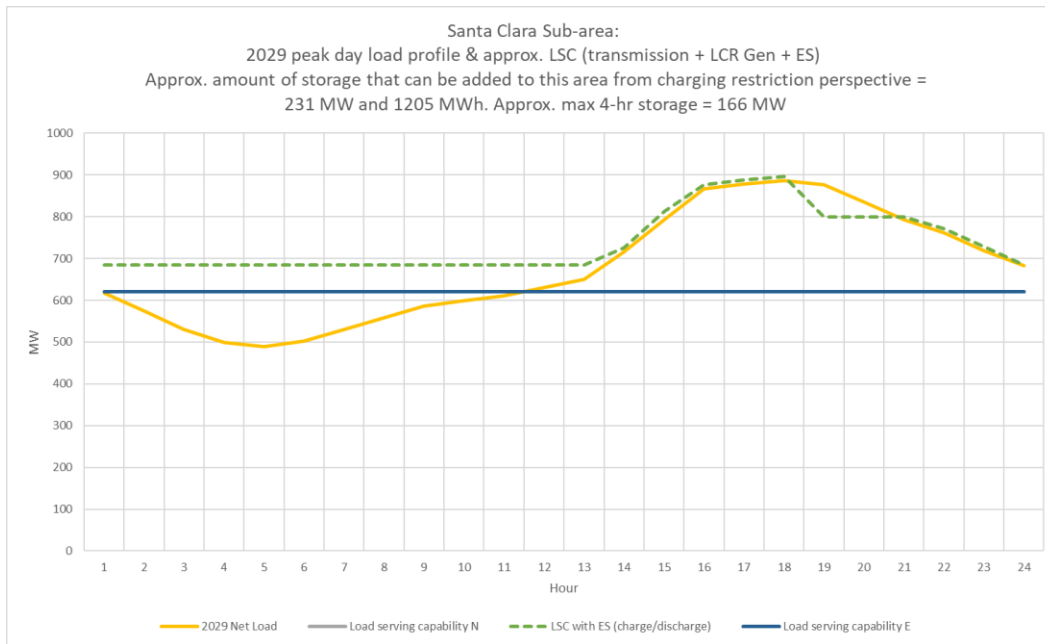

Figure 3.2-70 Santa Clara LCR Sub-area 2029 Load Shape and Estimated Maximum Energy Storage Capacity and Energy Based on Charging Capability Under Critical Contingency



3.2.8.5.4 Santa Clara LCR Sub-area Requirement

Table 3.2-58 identifies the sub-area requirement. The LCR requirement for Category P1 + P7 contingency is 265 MW.

Table 3.2-58 Santa Clara LCR Sub-area Requirements

Year	Limit	Category	Limiting Facility	Contingency	LCR (MW) (Deficiency)
2029	First Limit	P1 + P7	Voltage collapse	Pardee–Santa Clara 230 kV line followed by Moorpark–Santa Clara # 1 and #2 230 kV DCTL	265

3.2.8.5.5 Effectiveness factors:

For helpful procurement information please read procedure 2210Z Effectiveness Factors under 7500, 7510, 7550 , 7680 and 8610 posted at: <http://www.caiso.com/Documents/2210Z.pdf>

3.2.8.6 Big Creek/Ventura Overall

3.2.8.6.1 Big Creek/Ventura LCR Sub-area Hourly Profiles

Figure 3.2-71 illustrates the forecast 2029 annual load profile in the Big Creek/Ventura LCR area with the Category P6 normal and emergency load serving capabilities without local capacity resources. Figure 3.2-72 provides the load shape for the peak load day, estimated energy storage maximum capacity and energy based on area maximum charging capability under the most critical contingency as well as estimated four-hour capacity amount.

Figure 3.2-71 Big Creek/Ventura LCR area 2029 Annual Load Profile with Estimated Transmission Only Load Serving Capability

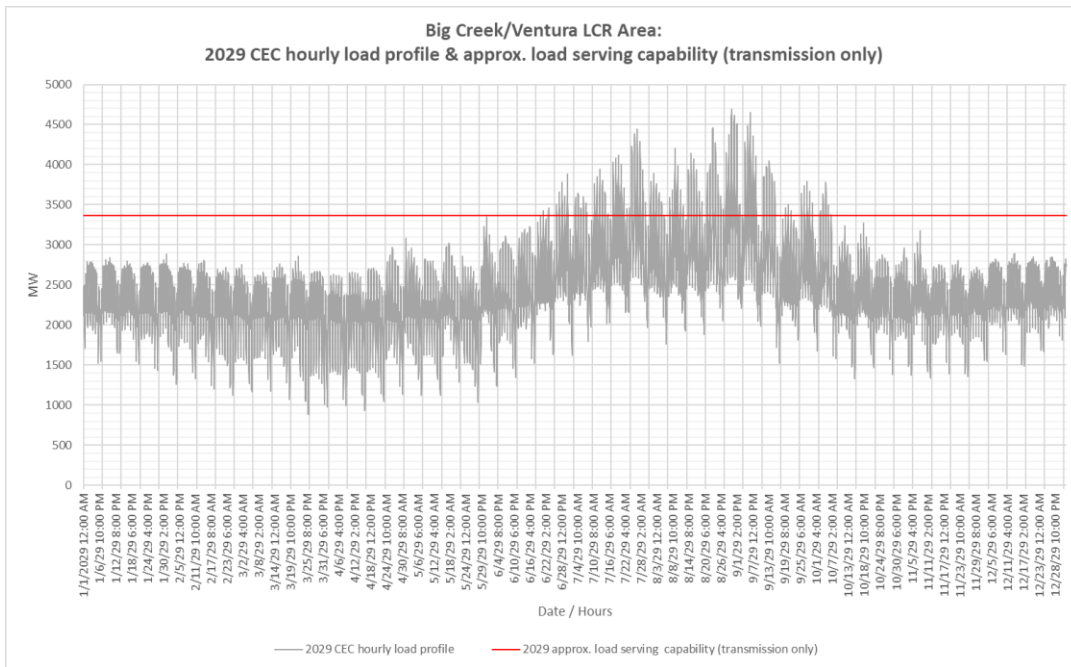
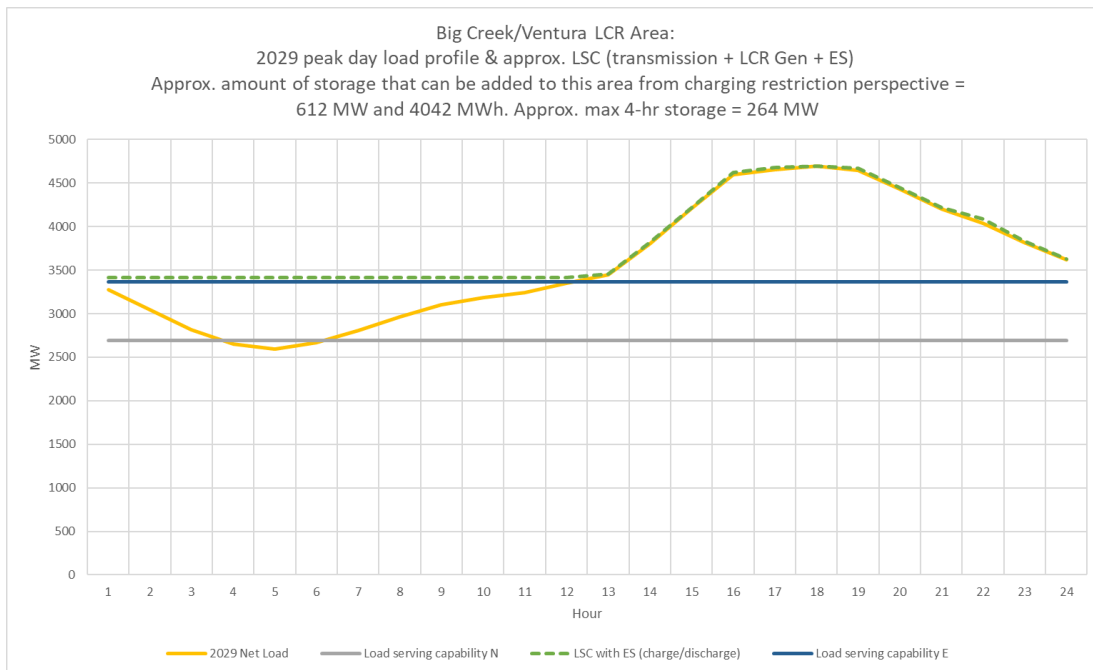

Figure 3.2-72 Big Creek/Ventura LCR area 2029 Load Shape and Estimated Maximum Energy Storage Capacity and Energy Based on Charging Capability Under Critical Contingency



3.2.8.6.2 Big Creek/Ventura LCR area Requirement

Table 3.2-59 identifies the area LCR requirements. The LCR requirement for Category P6 contingency is 1329 MW.

Table 3.2-59 Big Creek/Ventura LCR area Requirements

Year	Limit	Category	Limiting Facility	Contingency	LCR (MW)
2029	First Limit	P6	Remaining Sylmar - Pardee 230 kV	Lugo - Victorville 500 kV line followed by one of the Sylmar - Pardee #1 or #2 230 kV lines	1329

3.2.8.6.3 Effectiveness factors:

For helpful procurement information please read procedure 2210Z Effectiveness Factors under 7500, 7510, 7550, 7680 and 8610 posted at: <http://www.caiso.com/Documents/2210Z.pdf>

3.2.8.6.4 Changes compared to last year’s study

Compared with the results for 2028, the load forecast is up by 464 MW and the LCR went up by 113 MW mostly due to load forecast increase.

3.2.9 LA Basin Area

3.2.9.1 Area Definition:

The transmission tie lines into the LA Basin Area are:

- San Onofre - San Luis Rey #1, #2, and #3 230 kV Lines
- San Onofre - Talega #1 230 kV Lines
- San Onofre - Capistrano #1 230 kV Lines
- Lugo - Mira Loma #2 & #3 500 kV Lines
- Lugo - Rancho Vista #1 500 kV Line
- Vincent – Mesa 500 kV Line
- Sylmar - Eagle Rock 230 kV Line
- Sylmar - Gould 230 kV Line
- Vincent - Mesa #1 & #2 230 kV Lines
- Vincent - Rio Hondo #1 & #2 230 kV Lines
- Devers - Red Bluff 500 kV #1 and #2 Lines
- Mirage – Coachella Valley # 1 230 kV Line
- Mirage - Ramon # 1 and # 2 230 kV Lines
- Mirage - Julian Hinds 230 kV Line

The substations that delineate the LA Basin Area are:

- San Onofre is in San Luis Rey is out
- San Onofre is in Talega is out
- San Onofre is in Capistrano is out
- Mira Loma is in Lugo is out
- Rancho Vista is in Lugo is out
- Eagle Rock is in Sylmar is out
- Gould is in Sylmar is out
- Mira Loma is in Vincent is out
- Mesa is in Vincent is out
- Rio Hondo is in Vincent is out
- Devers is in Red Bluff is out
- Mirage is in Coachella Valley is out
- Mirage is in Ramon is out
- Mirage is in Julian Hinds is out

3.2.9.1.1 LA Basin LCR Area Diagram

Figure 3.2-73 LA Basin LCR Area

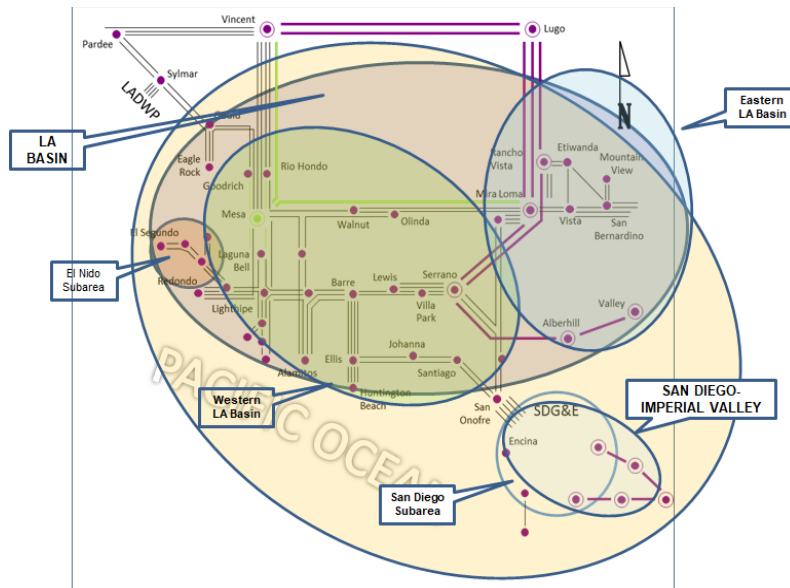

3.2.9.1.2 LA Basin LCR Area Load and Resources

Table 3.2-60 provides the forecast load and resources in the LA Basin LCR area. The list of generators within the LCR area are provided in Attachment A and does not include LTPP Preferred resources or DR.

In year 2029 the estimated time of local area peak is 5:00 PM (PDT) on August 29, 2029.

At the local area peak time the estimated, ISO metered, solar output is 12.4%.

If required, all non-solar technology type resources are dispatched at NQC.

Table 3.2-60 LA Basin LCR Area 2029 Forecast Load and Resources

Load (MW)		Generation (MW)	Aug NQC	At Peak
Gross Load	19043	Market, Net Seller, Wind	5670	5670
AAEE, AAFS & AATE	333	Battery	2696	2696
Behind the meter DG	-193	Muni/QF	1157	1157
Net Load	19183	Local Capacity Preferred Resources (BTM BESS, EE, DR, PV)	175	175
Transmission Losses	413	Existing Demand Response	588	588
Pumps	0	Solar	10	10
Load + Losses + Pumps	19596	Total	10296	10296

3.2.9.1.3 Approved transmission and resource projects modeled:

- Mesa Loop-In Project and Laguna Bell Corridor 230 kV line upgrades
- Ten West Link (aka Delaney – Colorado River 500 kV Line)
- West of Devers 230 kV Upgrades
- Retirement of Redondo Beach OTC generation (Units 5, 6 and 8)
- Retirement of Alamitos OTC generation (Units 3, 4, and 5)
- Retirement of Huntington Beach OTC generation
- Alamitos Repowering Project
- Alamitos Battery Energy Storage System
- Huntington Beach Repowering Project
- Stanton Energy Reliability Center
- Various battery energy storage system projects in the LA Basin

3.2.9.2 El Nido Sub-area

El Nido is sub-area of the LA Basin LCR area.

3.2.9.2.1 El Nido LCR Sub-area Diagram

Please refer to Figure 3.2-73 above.

3.2.9.2.2 El Nido LCR Sub-area Load and Resources

Table 3.2-61 provides the forecast load and resources in El Nido LCR sub-area. The list of generators within the LCR sub-area are provided in Attachment A.

Table 3.2-61 El Nido LCR Sub-area 2029 Forecast Load and Resources

Load (MW)		Generation (MW)	Aug NQC	At Peak
Gross Load	906	Market/NetSeller	554	554
AAEE, AAFS & AATE	16	Battery	100	100
Behind the meter DG	-34	MUNI/QF	0	0
Net Load	888	LTPP Preferred Resources	10	10
Transmission Losses	18	Existing Demand Response	30	30
Pumps	0	Solar	0	0
Load + Losses + Pumps	906	Total	692	692

3.2.9.2.3 El Nido LCR Sub-area Hourly Profiles

Figure 3.2-74 illustrates the forecast 2029 annual load profile in the El Nido LCR sub-area with the Category P7 normal and emergency load serving capabilities without local resources. Figure 3.2-75 provides load shape for peak load day, estimated energy storage maximum capacity and energy as well as estimated four-hour capacity amount based on its maximum charging capability under the most critical contingency.

Figure 3.2-74 EL Nido LCR Sub-area 2029 Annual Load Profile with Estimated Transmission Load Serving Capability Only

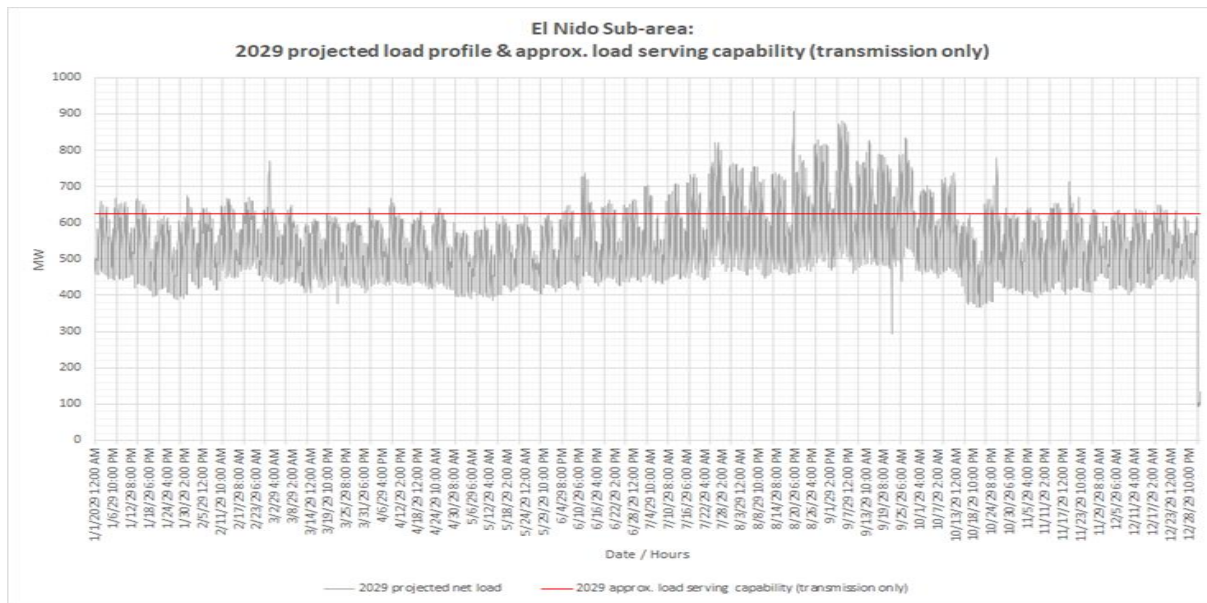
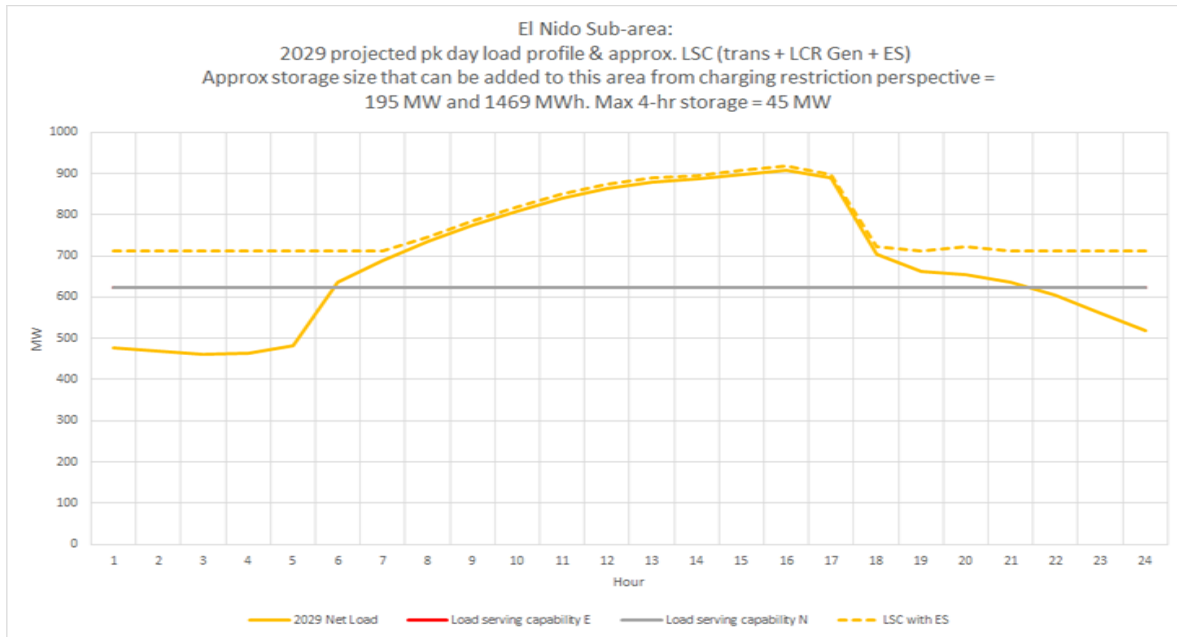

Figure 3.2-75 El Nido LCR Sub-area 2029 Load Shape and Estimated Maximum Energy Storage Capacity and Energy Based on Charging Capability Under Critical Contingency



3.2.9.2.4 El Nido LCR Sub-area Requirement

Table 3.2-62 identifies the sub-area requirements. The LCR requirement for Category P7 contingency is 284 MW.

Table 3.2-62 El Nido LCR Sub-area Requirements

Year	Limit	Category	Limiting Facility	Contingency	LCR (MW) (Deficiency)
2029	First Limit	P7	La Fresa-La Cienega 230 kV	La Fresa – El Nido #3 & #4 230 kV	284

3.2.9.2.5 Effectiveness factors:

All units within the El Nido sub-area have the same effectiveness factor.

For most helpful procurement information please read procedure 2210Z Effectiveness Factors under 7630 posted at: <http://www.caiso.com/Documents/2210Z.pdf>

3.2.9.3 Western LA Basin Sub-area

Western LA Basin is a sub-area of the LA Basin LCR area.

3.2.9.3.1 Western LA Basin LCR Sub-area Diagram

Please refer to Figure 3.2-73 above.

3.2.9.3.2 Western LA Basin LCR Sub-area Load and Resources

Table 3.2-63 provides the forecast load and resources in Western LA Basin LCR sub-area in 2029. The list of generators within the LCR sub-area are provided in Attachment A.

Table 3.2-63 Western LA Basin Sub-area 2029 Forecast Load and Resources

Load (MW)		Generation (MW)	Aug NQC	At Peak
Gross Load	11681	Market/Net Seller	3343	3343
AAEE, AAFS & AATE	209	Battery/Hybrid	719	719
Behind the meter DG	-503	MUNI/QF	593	593
Net Load	11387	LTPP Preferred Resources (BTM BESS, EE, DR, PV)	175	175
Transmission Losses	228	Existing Demand Response	337	337
Pumps	0	Solar	7	7
Load + Losses + Pumps	11615	Total	5174	5174

3.2.9.3.3 Western LA Basin LCR Sub-area Hourly Profiles

Figure 3.2-76 illustrates the forecast 2029 annual load profile in the Western LA Basin LCR sub-area with the transmission load serving capability only. Figure 3.2-77 provides load shape for peak load day, estimated energy storage maximum capacity and energy as well as estimated four-hour capacity amount based on its maximum charging capability under the most critical contingency.

Figure 3.2-76 Western LA Basin LCR Sub-area 2029 Annual Load Profile with Estimated Transmission Load Serving Capability Only

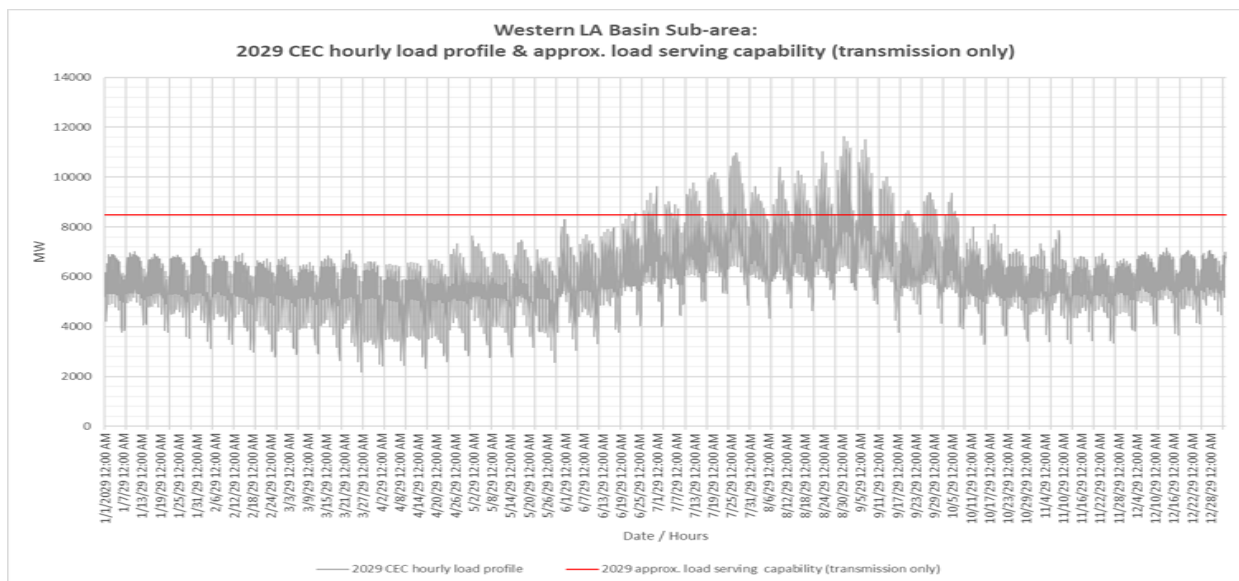
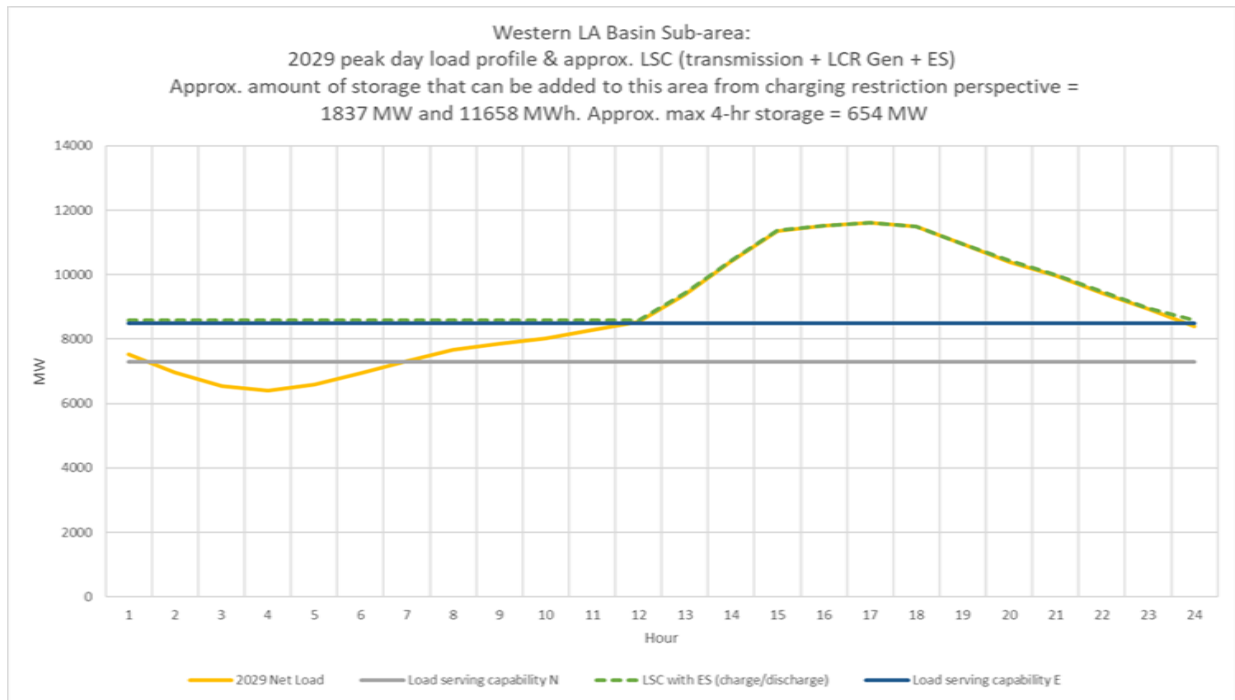

Figure 3.2-77 Western LA Basin LCR Sub-area 2029 Load Shape and Estimated Maximum Energy Storage Capacity and Energy Based on Charging Capability Under Critical Contingency



3.2.9.3.4 Western LA Basin LCR Sub-area Requirement

Table 3.2-64 identifies the sub-area LCR requirements. The LCR requirement for Category P6 contingency is 3053 MW. The 2029 LCR need is lower than 2028 LCR need due to lower demand forecast, as well as having two in-basin transmission projects anticipated to be in-service (Laguna Bell – Mesa #1 230 kV line upgrade and installation of the 4th Serrano AA 500/230 kV transformer bank).

Table 3.2-64 Western LA Basin LCR Sub-area Requirements

Year	Limit	Category	Limiting Facility	Contingency	LCR (MW) (Deficiency)
2029	FirstLimit	P6	Mesa – Lighthipe 230 kV Line	Mesa-Redondo #1 230 kV, followed by Laguna Bell-Mesa #1 230 kV line (or vice versa)	3053

3.2.9.3.5 Effectiveness factors:

For helpful procurement information please read procedure 2210Z Effectiveness Factors under 7630 posted at: <http://www.caiso.com/Documents/2210Z.pdf>

There are other combinations of contingencies in the area that could overload a significant number of 230 kV lines in this sub-area have less LCR need. As such, anyone of them (combination of contingencies) could become binding for any given set of procured resources.

As a result, these effectiveness factors may not be the best indicator towards informed procurement.

3.2.9.4 West of Devers Sub-area

West of Devers is a sub-area of the LA Basin LCR area.

There are no LCR needs for this sub-area due to implementation of prior transmission upgrades.

3.2.9.5 Valley-Devers Sub-area

Valley-Devers is a sub-area of the LA Basin LCR area.

The are no LCR needs for this sub-area due to implementation of prior transmission upgrades.

3.2.9.6 Valley Sub-area

Valley is a sub-area of the LA Basin LCR area.

There are no LCR needs for this sub-area due to implementation of prior transmission upgrades.

3.2.9.7 Eastern LA Basin Sub-area

Eastern LA Basin is a sub-area of the LA Basin LCR area.

3.2.9.7.1 Eastern LA Basin LCR Sub-area Diagram

Please refer to Figure 3.2-73 above.

3.2.9.7.2 Eastern LA Basin LCR Sub-area Load and Resources

Table 3.2-65 provides the forecast load and resources in Eastern LA Basin LCR sub-area. The list of generators within the LCR sub-area are provided in Attachment A.

Table 3.2-65 Eastern LA Basin Sub-area 2029 Forecast Load and Resources

Load (MW)		Generation (MW)	Aug NQC	At Peak
Gross Load	7932	Market/Net Seller/Wind	2327	2327
AAEE, AAFS & AATE	124	Battery	1976	1976
Behind the meter DG	-260	MUNI/QF	564	564
Net Load	7796	LTPP Preferred Resources	0	0
Transmission Losses	156	Existing Demand Response	206	206
Pumps	0	Solar	4	4
Load + Losses + Pumps	7951	Total	5077	5077

3.2.9.7.3 Eastern LA Basin LCR Sub-area Hourly Profiles

Figure 3.2-78 illustrates the forecast 2029 annual load profile in the Eastern LA Basin LCR sub-area with the transmission load serving capability only. Figure 3.2-79 provides load shape for peak load day, estimated energy storage maximum capacity and energy as well as estimated four-hour capacity amount based on its maximum charging capability under the most critical contingency.

Figure 3.2-78 Eastern LA Basin LCR Sub-area 2029 Annual Load Profile with Estimated Transmission Load Serving Capability Only

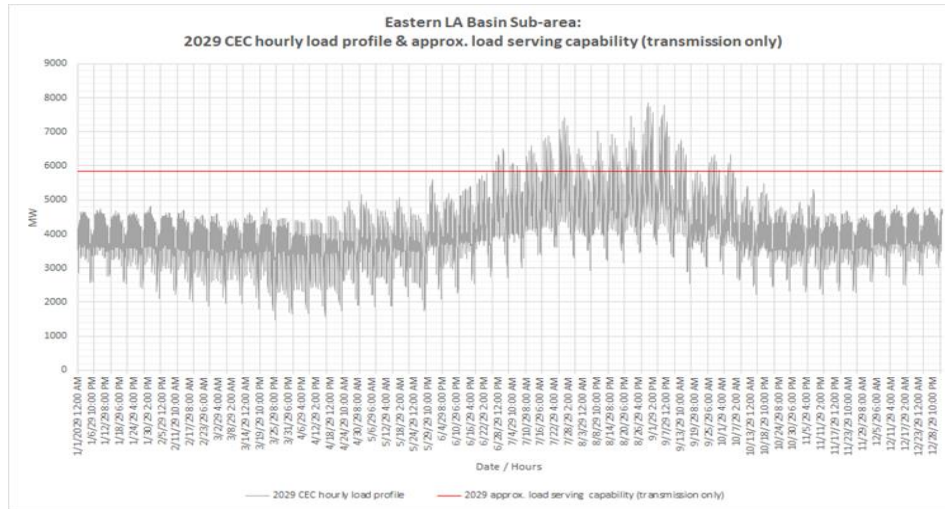
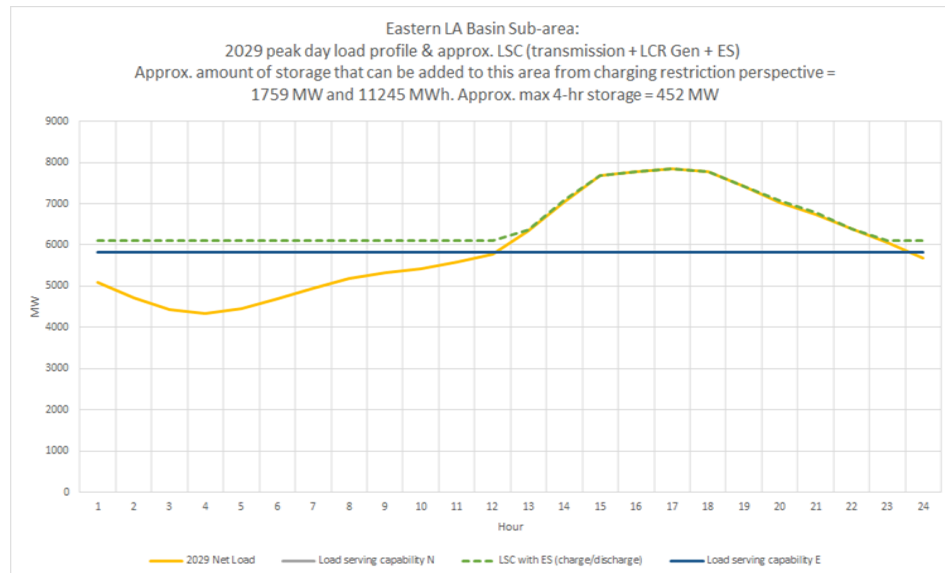

Figure 3.2-79 Eastern LA Basin LCR Sub-area 2029 Load Shape and Estimated Maximum Energy Storage Capacity and Energy Based on Charging Restriction Perspective Under Critical Contingency



3.2.9.7.4 Eastern LA Basin LCR Sub-area Requirement

Table 3.2-66 identifies the sub-area LCR requirements. The LCR requirement for Category P1 and P7 contingency is 2023 MW. The 2029 LCR need for the Eastern LA Basin is higher than the

2028 local capacity need due to having lower western LA Basin LCR requirement for 2029. Even though the western and eastern LA Basin have different limiting constraints and contingencies, the LCR needs for these two sub-areas are still influenced by the amount of generation dispatch and requirement in each area due to strong transmission ties between these two sub-areas.

Table 3.2-66 Eastern LA Basin LCR Sub-area Requirements

Year	Limit	Category	Limiting Facility	Contingency	LCR (MW) (Deficiency)
2029	First Limit	P1 & P7	Voltage stability	Lugo–Rancho Vista 500 kV line, followed by N-2 of Lugo-Mira Loma #2 and #3 500 kV lines (common structure)	2023

3.2.9.7.5 Effectiveness factors:

All units within the Eastern LA Basin sub-area have the same effectiveness factor.

For most helpful procurement information please read procedure 2210Z Effectiveness Factors under 7750 posted at: <http://www.caiso.com/Documents/2210Z.pdf>

3.2.9.8 LA Basin Overall

3.2.9.8.1 LA Basin LCR Sub-area Hourly Profiles

The following table is a summary of estimated amount of storage for the sub-areas and the overall area based on maximum charging capability perspective. The LA Basin overall estimated maximum amount of storage represents the sum of the Western and Eastern sub-areas estimated maximum amounts of storage and is listed in the last row in the table below.

Table 3.2-67 Estimated LA Basin Sub-areas and Overall Area Energy Storage Capacity and Energy Based on Maximum Charging Capability Perspective

Area/Sub-area	Estimated Energy Storage Maximum Capacity (MW)	Estimated Energy Storage Maximum Energy (MWh)	1 for 1 replacement with 4-hour Energy Storage Capacity (MW)
El Nido sub-area	195	1469	45
Western LA Basin sub-area	1837	11658	654
Eastern LA Basin sub-area	1759	11245	452
Overall LA Basin Area	3596	22903	1106

3.2.9.8.2 LA Basin LCR area Requirement

Table 3.2-68 identifies the area requirements. The LCR requirement is driven by the sum of the LCR needs for the Western LA Basin and Eastern LA Basin sub-areas, at 5076 MW.

Table 3.2-68 LA Basin LCR area Requirements

Year	Limit	Category	Limiting Facility	Contingency	LCR (MW) (Deficiency)
2028	First Limit	N/A	Sum of Western and Eastern.		5076

3.2.9.8.3 Effectiveness factors:

For helpful procurement information please read procedure 2210Z Effectiveness Factors under 7550, 7570, 7580, 7590, 7590, 7680 and 7750 posted at: <http://www.caiso.com/Documents/2210Z.pdf>

There are other combinations of contingencies in the area that could overload a significant number of 230 kV lines in this sub-area have less LCR need. As such, anyone of them (combination of contingencies) could become binding for any given set of procured resources. As a result, these effectiveness factors may not be the best indicator towards informed procurement.

3.2.9.8.4 Changes compared to last year’s study

Compared with the previous year’s 2028 demand forecast, the load is 754 MW lower and the LCR needs have decreased by 864 MW due to the following:

- Lower demand forecast for the LA Basin;
- Addition of new transmission upgrades in the western LA Basin.

3.2.10 San Diego-Imperial Valley Area

3.2.10.1 Area Definition:

The transmission tie lines forming a boundary around the Greater San Diego-Imperial Valley area include:

- Imperial Valley – North Gila 500 kV Line
- Otay Mesa – Tijuana 230 kV Line
- San Onofre – San Luis Rey #1 230 kV Line
- San Onofre – San Luis Rey #2 230 kV Line

- San Onofre – San Luis Rey #3 230 kV Line
- San Onofre – Talega 230 kV Line
- San Onofre – Capistrano 230 kV Line
- Imperial Valley – Wixom – El Centro 230 kV Line
- Imperial Valley – La Rosita 230 kV Line

The substations that delineate the Greater San Diego-Imperial Valley area are:

- Imperial Valley is in North Gila is out
- Otay Mesa is in Tijuana is out
- San Onofre is out San Luis Rey is in
- San Onofre is out San Luis Rey is in
- San Onofre is out San Luis Rey is in
- San Onofre is out Talega is in
- San Onofre is out Capistrano is in
- Imperial Valley is in Wixom - El Centro is out
- Imperial Valley is in La Rosita is out

3.2.10.1.1 San Diego-Imperial Valley LCR Area Diagram

Figure 3.2-80 San Diego-Imperial Valley LCR Area

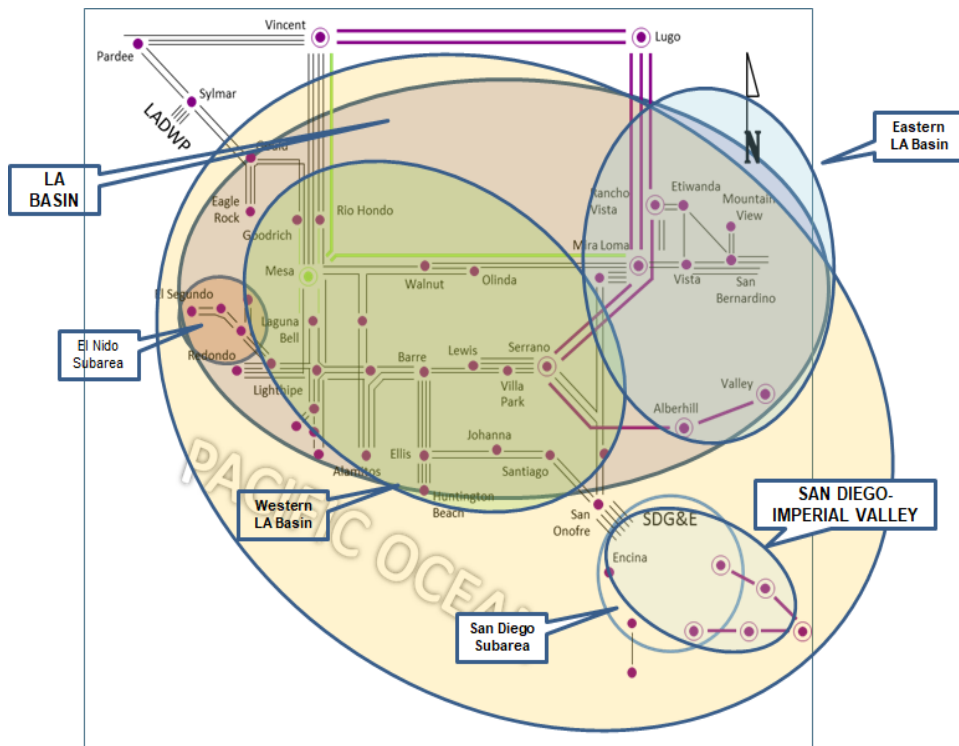

3.2.10.1.2 San Diego-Imperial Valley LCR Area Load and Resources

Table 3.2-69 provides the forecast load and resources in the San Diego-Imperial Valley LCR area in 2029. The list of generators within the LCR area are provided in Attachment A.

In year 2029 the estimated time of local area peak is 5:00 PM PDT on September 4, 2029 from the CEC hourly demand forecast.⁴

At the local area peak time the estimated, the ISO metered solar output is 11.1%.

If required, all non-solar technology type resources are dispatched at NQC.

Table 3.2-69 San Diego-Imperial Valley LCR Area 2029 Forecast Load and Resources

Load (MW)		Generation (MW)	Aug NQC	At Peak
Gross Load	5063	Market/NetSeller/Wind	3707	3707
AAEE, AAFS & AATE	125	Battery/Hybrid	1904	1904
Behind the meter DG	-282	MUNI/QF	3	3
Net Load	4906	LTPP Preferred Resources	0	0
Transmission Losses	137	Existing Demand Response	26	26
Pumps	0	Solar	169	169
Load + Losses + Pumps	5046	Total	5809	5809

3.2.10.1.3 Approved transmission projects modeled:

1. S-Line (aka Imperial Valley – El Centro 230kV) upgrade
2. Southern Orange County Reliability Upgrade Project – Alternative 3 (Rebuild Capistrano Substation, construct a new SONGS - Capistrano 230 kV line and a new 230 kV tap line to Capistrano)
3. TL649D Reconductor (San Ysidro - Otay Lake Tap)
4. Reconductor TL 605 Silvergate - Urban
5. TL695B Japanese Mesa - Talega Tap Reconductor
6. TL632 Granite Loop-In and TL6914 Reconfiguration
7. Sweetwater Reliability Enhancement
8. TL690E, Stuart Tap - Las Pulgas 69 kV Reconductor

The 500kV line series capacitors on the Southwest Powerlink and Sunrise Powerlink lines are bypassed in the study case.

⁴ <https://www.energy.ca.gov/data-reports/reports/integrated-energy-policy-report/2023-integrated-energy-policy-report/2023-1>

3.2.10.2 **El Cajon Sub-area**

El Cajon sub-area will be eliminated after the TL632 Granite loop-in and TL6914 reconfiguration projects are in-service.

3.2.10.3 **Border Sub-area**

Border is a sub-area of the San Diego-Imperial Valley LCR area.

3.2.10.3.1 **Border LCR Sub-area Diagram**

Figure 3.2-81 Border LCR Sub-area

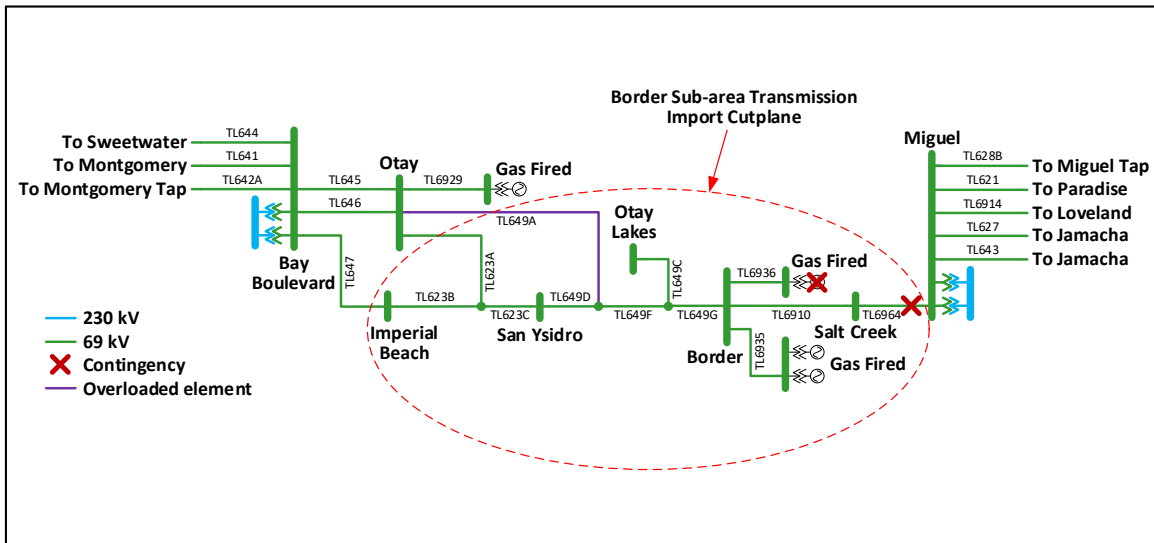

3.2.10.3.2 **Border LCR Sub-area Load and Resources**

Table 3.2-70 provides the forecast load and resources in Border LCR sub-area. The list of generators within the LCR sub-area are provided in Attachment A.

Table 3.2-70 Border Sub-area 2029 Forecast Load and Resources

Load (MW)		Generation (MW)	Aug NQC	At Peak
Gross Load	192	Market, Net Seller	149	149
AAEE	-3	Solar	0	0
Behind the meter DG	-24	QF	0	0
Net Load	165	LTPP Preferred Resources	0	0
Transmission Losses	1	Demand Response	0	0
Pumps	0	Battery	0	0
Load + Losses + Pumps	166	Total	149	149

3.2.10.3.3 Border LCR Sub-area Hourly Profiles

Figure 3.2-82 illustrates the forecast 2029 annual load forecast profile in the Border LCR sub-area and the Category P1 (L-1 Contingency) transmission load serving capability without generation. Figure 3.2-83 provides the 2029 daily load forecast profile for the peak day, estimated amount of energy storage that can be added to this local area from charging restriction perspective, and estimated four-hour capacity amount under the most critical contingency.

Figure 3.2-82 Border LCR Sub-area 2029 Annual Load Forecast Profiles

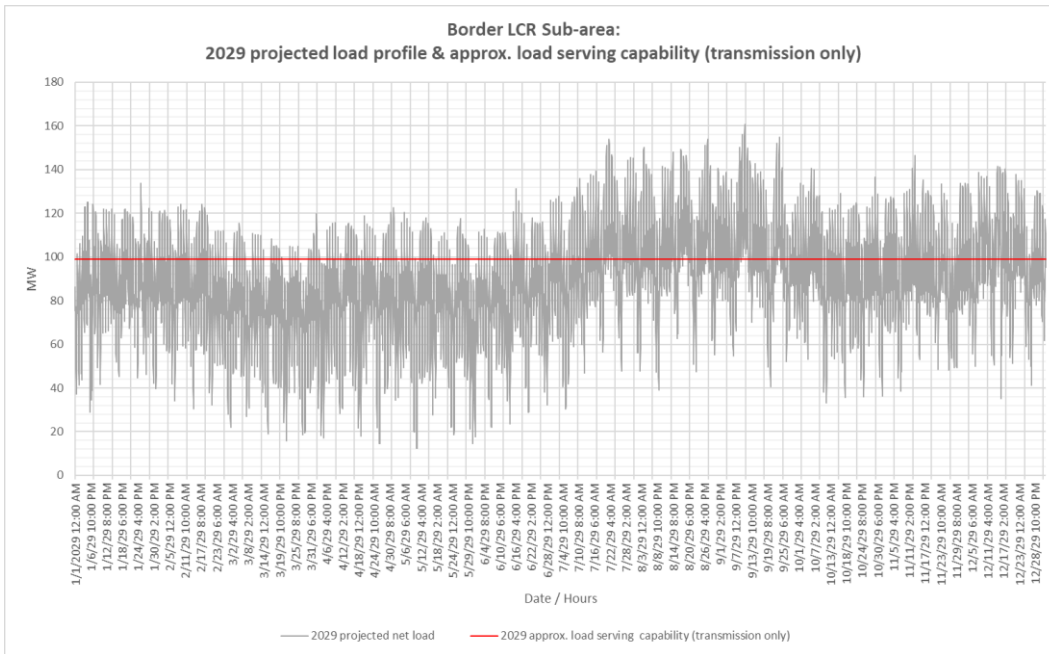
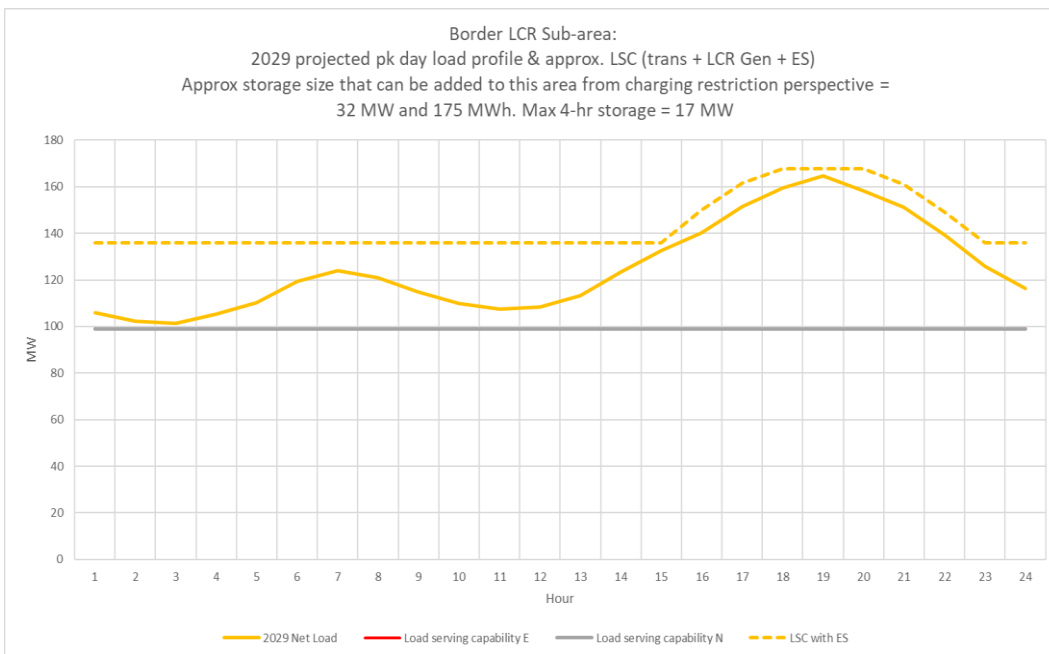

Figure 3.2-83 Border LCR Sub-area 2029 Peak Day Forecast Profiles



3.2.10.3.4 Border LCR Sub-area Requirement

Table 3.2-71 identifies the sub-area requirements. The LCR requirement for Category P3 contingency is 97 MW.

Table 3.2-71 Border 2029 LCR Sub-area Requirements

Year	Category	Limiting Facility	Contingency	LCR (MW) (Deficiency)
2029	P3	Otay – Otay Lakes Tap 69 kV (TL649A)	Border unit out of service followed by the outage of Miguel-Salt Creek 69 kV (TL6964)	97

3.2.10.3.5 Effectiveness factors:

All units within the Border sub-area have the same effectiveness factor.

3.2.10.4 San Diego Sub-area

San Diego is a sub-area of the San Diego-Imperial Valley LCR area.

3.2.10.4.1 San Diego LCR Sub-area Diagram

Please refer to Figure 3.2-80 above.

3.2.10.4.2 San Diego LCR Sub-area Load and Resources

Table 3.2-72 provides the forecast load and resources in San Diego LCR sub-area. The list of generators within the LCR sub-area are provided in Attachment A.

Table 3.2-72 San Diego Sub-area 2029 Forecast Load and Resources

Load (MW)		Generation (MW)	Aug NQC	At Peak
Gross Load	5063	Market/Net Seller/Wind	2735	2735
AAEE	125	Battery/Hybrid	1459	1459
Behind the meter DG	-282	MUNI/QF	3	3
Net Load	4906	LTPP Preferred Resources	0	0
Transmission Losses	140	Existing Demand Response	26	26
Pumps	0	Solar	7	7
Load + Losses + Pumps	5046	Total	4230	4230

3.2.10.4.3 San Diego LCR Sub-area Hourly Profiles

Figure 3.2-84 illustrates the forecast 2029 annual load profile in the San Diego LCR sub-area with the transmission load serving capability only. Figure 3.2-85 provides load shape for peak load

day, estimated energy storage maximum capacity and energy as well as estimated four-hour capacity amount based on its maximum charging capability under the most critical contingency.

Figure 3.2-84 San Diego LCR Sub-area 2029 Annual Load Profile with Estimated Transmission Load Serving Capability Only

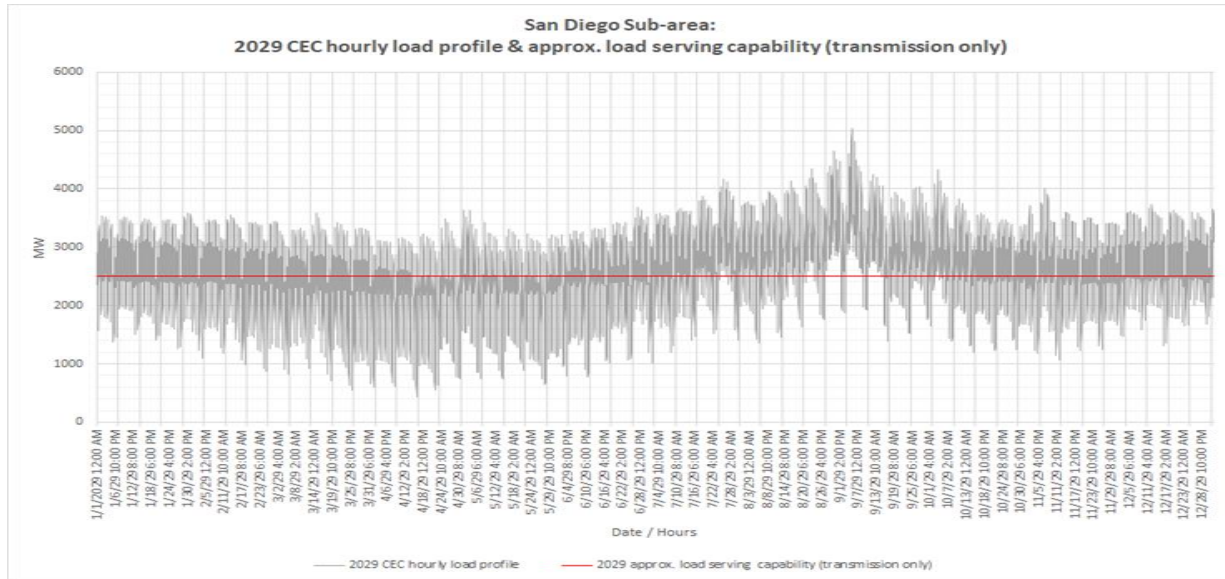
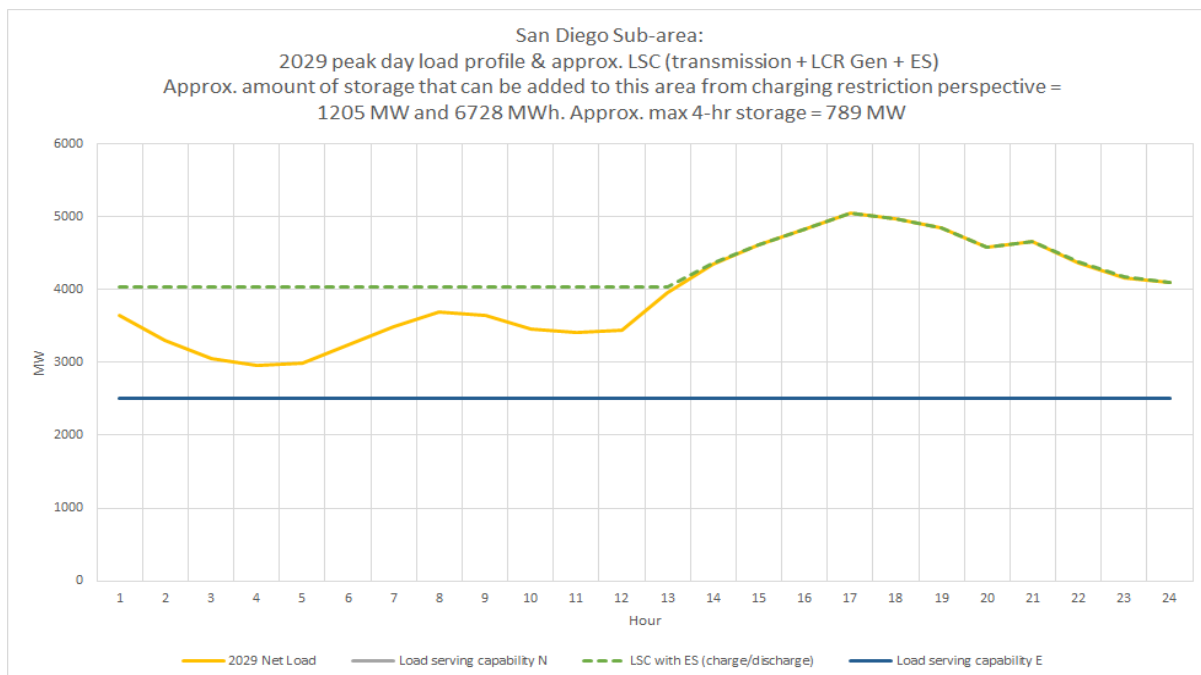

Figure 3.2-85 San Diego LCR Sub-area 2029 Load Shape and Estimated Maximum Energy Storage Capacity and Energy Based on Charging Capability Under Critical Contingency



3.2.10.4.4 San Diego LCR Sub-area Requirement

Table 3.2-73 identifies the sub-area LCR requirements. The LCR requirement for Category P6 contingency is 3121 MW.

Table 3.2-73 San Diego LCR Sub-area Requirements

Year	Limit	Category	Limiting Facility	Contingency	LCR (MW) (Deficiency)
2029	First Limit	P6	Remaining Sycamore – Suncrest 230 kV	Eco – Miguel 500 kV, system readjustment, followed by one of the Sycamore – Suncrest 230 kV lines (or vice versa)	3121

3.2.10.4.5 Effectiveness factors:

See Attachment B - Table titled [San Diego](#).

For other helpful procurement information please read procedure 2210Z Effectiveness Factors under 7820 posted at: <http://www.caiso.com/Documents/2210Z.pdf>

3.2.10.5 San Diego-Imperial Valley Overall

3.2.10.5.1 San Diego-Imperial Valley LCR area Hourly Profiles

Since the San Diego sub-area has all the substation loads, the overall San Diego-Imperial Valley area has the same load profile as the San Diego bulk sub-area. The Imperial Valley area has extra generating resources. With the implementation of the S-line upgrade, additional LCR need beyond the San Diego sub-area need is eliminated. Thus, the LCR need for the overall San Diego-Imperial Valley LCR area is the same as the San Diego bulk sub-area.

The following is a summary of estimated amount of storage for the sub-areas and the overall area based on maximum charging capability perspective. Due to non-linearity of power system and the various critical contingencies and load shapes for each sub-area and the overall area, it is noted that the estimated maximum amount of storage for the sub-areas many not add up to be sum of the overall area. Since the San Diego sub-area has all the substation loads, the overall San Diego-Imperial Valley area has the same load profile as the San Diego bulk sub-area and therefore same amount of energy storage for the San Diego sub-area.

Table 3.2-74 Estimated San Diego Sub-areas and Overall Area Energy Storage Capacity and Energy Based on Maximum Charging Capability Perspective

Area/Sub-area	Estimated Energy Storage Maximum Capacity (MW)	Estimated Energy Storage Maximum Energy (MWh)	1 for 1 Replacement with 4-hour Energy Storage Capacity (MW)
Border sub-area	32	175	17
San Diego bulk sub-area	1205	6728	789
San Diego-Imperial Valley Area	1205	6728	789

3.2.10.5.2 San Diego-Imperial Valley LCR area Requirement

Table 3.2-75 identifies the area LCR requirements. The LCR requirement for Category P6 contingency is 3121 MW. The LCR need for the overall San Diego-Imperial Valley is the same as the LCR need for the San Diego bulk sub-area.

Table 3.2-75 San Diego-Imperial Valley LCR area Requirements

Year	Limit	Category	Limiting Facility	Contingency	LCR (MW) (Deficiency)
2029	First Limit	P6	Same constraint as in the San Diego sub-area	Same contingency as in the San Diego sub-area	3121

3.2.10.5.3 Effectiveness factors:

See Attachment B - Table titled [San Diego](#).

For other helpful procurement information please read procedure 2210Z Effectiveness Factors under 7820 posted at: <http://www.caiso.com/Documents/2210Z.pdf>

3.2.10.5.4 Changes compared to last year’s study

Compared with the 2028 the modeled demand forecast is lower by 175 MW. The overall LCR need for the San Diego – Imperial Valley area has decreased by about 454 MW due to lower demand forecast from the CEC.

3.2.11 Valley Electric Area

Valley Electric Association LCR area has been eliminated on the basis of the following:

No generation exists in this area

No category B issues were observed in this area

Category C and beyond –

- No common-mode N-2 issues were observed
- No issues were observed for category B outage followed by a common-mode N-2 outage
- All the N-1-1 issues that were observed can either be mitigated by the existing UVLS or by an operating procedure

Attachment A - List of physical resources accounted for in the 2025 and 2029 Local Capacity
Technical studies

Attachment A - List of physical resources accounted for in the 2025 and 2029 Local Capacity Technical studies

[https://www.caiso.com/InitiativeDocuments/AttachmentA-
ListofPhysicalResourcesAccountedforinthe2025and2029LocalCapacityTechnicalStudies.xls](https://www.caiso.com/InitiativeDocuments/AttachmentA-ListofPhysicalResourcesAccountedforinthe2025and2029LocalCapacityTechnicalStudies.xls)

Attachment B – Effectiveness factors for procurement guidance

Table - Eagle Rock.

Effectiveness factors to the Eagle Rock-Cortina 115 kV line:

Gen Bus	Gen Name	Gen ID	Eff Factor (%)
31406	GEYSR5-6	1	36
31406	GEYSR5-6	2	36
31408	GEYSER78	1	36
31408	GEYSER78	2	36
31412	GEYSER11	1	37
31435	GEO.ENGY	1	35
31435	GEO.ENGY	2	35
31433	POTTRVLY	1	34
31433	POTTRVLY	3	34
31433	POTTRVLY	4	34
38020	CITYUKH	1	32
38020	CITYUKH	2	32

Table - Fulton

Effectiveness factors to the Lakeville-Petaluma-Cotati 60 kV line:

Gen Bus	Gen Name	Gen ID	Eff Factor (%)
31466	SONMA LF	1	52
31422	GEYSER17	1	12
31404	WEST FOR	1	12
31404	WEST FOR	2	12
31414	GEYSER12	1	12
31418	GEYSER14	1	12
31420	GEYSER16	1	12
31402	BEAR CAN	1	12
31402	BEAR CAN	2	12

Attachment B - Effectiveness factors for procurement guidance

Gen Bus	Gen Name	Gen ID	Eff Factor (%)
38110	NCPA2GY1	1	12
38112	NCPA2GY2	1	12
32700	MONTICLO	1	10
32700	MONTICLO	2	10
32700	MONTICLO	3	10
31435	GEO.ENGY	1	6
31435	GEO.ENGY	2	6
31408	GEYSER78	1	6
31408	GEYSER78	2	6
31412	GEYSER11	1	6
31406	GEYSR5-6	1	6
31406	GEYSR5-6	2	6

Table - Lakeville

Effectiveness factors to the Vaca Dixon-Lakeville 230 kV line:

Gen Bus	Gen Name	Gen ID	Eff Fctr (%)
31400	SANTA FE	2	38
31430	SMUDGE01	1	38
31400	SANTA FE	1	38
31416	GEYSER13	1	38
31424	GEYSER18	1	38
31426	GEYSER20	1	38
38106	NCPA1GY1	1	38
38108	NCPA1GY2	1	38
31421	BOTTLERK	1	36
31404	WEST FOR	2	36
31402	BEAR CAN	1	36
31402	BEAR CAN	2	36
31404	WEST FOR	1	36
31414	GEYSER12	1	36
31418	GEYSER14	1	36
31420	GEYSER16	1	36

Attachment B - Effectiveness factors for procurement guidance

Gen Bus	Gen Name	Gen ID	Eff Fctr (%)
31422	GEYSER17	1	36
38110	NCPA2GY1	1	36
38112	NCPA2GY2	1	36
31446	SONMALF	1	36
32700	MONTICLO	1	31
32700	MONTICLO	2	31
32700	MONTICLO	3	31
31406	GEYSR5-6	1	18
31406	GEYSR5-6	2	18
31405	RPSP1014	1	18
31408	GEYSER78	1	18
31408	GEYSER78	2	18
31412	GEYSER11	1	18
31435	GEO.ENGY	1	18
31435	GEO.ENGY	2	18
31433	POTTRVLY	1	15
31433	POTTRVLY	2	15
31433	POTTRVLY	3	15
38020	CITYUKH	1	15
38020	CITYUKH	2	15

Table – Rio Oso

Effectiveness factors to the Rio Oso-Atlantic 230 kV line:

Gen Bus	Gen Name	Gen ID	Eff Fctr. (%)
32498	SPILINCF	1	49
32500	ULTR RCK	1	49
32456	MIDLFORK	1	33
32456	MIDLFORK	2	33
32458	RALSTON	1	33
32513	ELDRADO1	1	32
32514	ELDRADO2	1	32
32510	CHILIBAR	1	32

Attachment B - Effectiveness factors for procurement guidance

32486	HELLHOLE	1	31
32508	FRNCH MD	1	30
32460	NEWCSTLE	1	26
32478	HALSEY F	1	24
32512	WISE	1	24
38114	Stg CC	1	14
38123	Q267CT	1	14
38124	Q267ST	1	14
32462	CHI.PARK	1	8
32464	DTCHFLT1	1	4

Table – Sierra Overall

Effectiveness factors to the Table Mountain – Pease 60 kV line:

Gen Bus	Gen Name	Gen ID	Eff Fctr. (%)
32492	GRNLEAF2	1	17
32494	YUBACTY	1	17
32496	YCEC	1	17
31794	WOODLEAF	1	6
31814	FORBSTWN	1	6
31832	SLY.CR.	1	6
31834	KELLYRDG	1	6
31888	OROVLENRG	1	6
32451	FREC	1	5
32450	COLGATE1	1	5
32466	NARROWS1	1	5
32468	NARROWS2	1	5
32470	CMP.FARW	1	5
32452	COLGATE2	1	5
32156	WOODLAND	1	4
32498	SPILINCF	1	4
32502	DTCHFLT2	1	4
32454	DRUM 5	1	3
32474	DEER CRK	1	3

Attachment B - Effectiveness factors for procurement guidance

Gen Bus	Gen Name	Gen ID	Eff Fctr. (%)
32476	ROLLINSF	1	3
32484	OXBOW F	1	3
32504	DRUM 1-2	1	3
32504	DRUM 1-2	2	3
32506	DRUM 3-4	1	3
32506	DRUM 3-4	2	3
32464	DTCHFLT1	1	3
32480	BOWMAN	1	3
32488	HAYPRES+	1	3
32488	HAYPRES+	2	3
32472	SPAULDG	1	3
32472	SPAULDG	2	3
32472	SPAULDG	3	3
32462	CHI.PARK	1	3
32500	ULTR RCK	1	3
31784	BELDEN	1	3
31786	ROCKCK1	1	3
31788	ROCKCK2	1	3
31790	POE 1	1	3
31792	POE 2	1	3
31812	CRESTA	1	3
31812	CRESTA	2	3
31820	BCKSCRK	1	3
31820	BCKSCRK	2	3
32478	HALSEY F	1	2
32512	WSE	1	2
32460	NEWCASTLE	1	2
32510	CHILIBAR	1	2
32513	ELDRADO1	1	2
32514	ELDRADO2	1	2
32456	MIDLFORK	1	2
32456	MIDLFORK	2	2
32458	RALSTON	1	2

Attachment B - Effectiveness factors for procurement guidance

Gen Bus	Gen Name	Gen ID	Eff Fctr. (%)
32486	HELLHOLE	1	2
32508	FRNCH MD	1	2
38114	STIGCC	1	1
38123	LODIST1	1	1
38124	LODIST1	1	1

Table – San Jose

Effectiveness factors to the Metcalf 230/115 kV transformer #1:

Gen Bus	Gen Name	Gen ID	Eff Fctr (%)
35637	IBM-CTLE	RT	67
35859	HGST-LV	RN	67
35850	GILROYENGCT	1	56
35851	GROYPKR1	1	56
35852	GROYPKR2	1	56
35853	GROYPKR3	1	56
35871	GILROYENGST	2	56
35863	CATALYST	RE	17
35863	CATALYST	1	17
36863	DVRaGT1	1	7
36864	DVRbG2	1	7
36865	DVRaST3	1	7
36895	Gia200	1	6
36858	Gia100	1	6
35861	SJ-SCL W	RN	5
35861	SJ-SCL W	1	5
35854	LECEFGT1	1	4
35855	LECEFGT2	1	4
35856	LECEFGT3	1	4
35857	LECEFGT4	1	4
35858	LECEFST1	1	4
35860	AGNEWCOGEN	1	4
35860	AGNEWCOGEN	2	4

Attachment B - Effectiveness factors for procurement guidance

Table – South Bay-Moss Landing

Effectiveness factors to the Moss Landing-Las Aguillas 230 kV line:

Gen Bus	Gen Name	Gen ID	Eff Fctr. (%)
36209	SLD ENRG	1	20
36221	DUKMOSS1	1	20
36222	DUKMOSS2	1	20
36223	DUKMOSS3	1	20
36224	DUKMOSS4	1	20
36225	DUKMOSS5	1	20
36226	DUKMOSS6	1	20
36405	MOSSLND6	1	17
36406	MOSSLND7	1	17
35881	MEC CTG1	1	13
35882	MEC CTG2	1	13
35883	MEC STG1	1	13
35850	GLRY COG	1	12
35850	GLRY COG	2	12
35851	GROYPKR1	1	12
35852	GROYPKR2	1	12
35853	GROYPKR3	1	12
35623	SWIFT	BT	10
35863	CATALYST	1	10
36863	DVRaGT1	1	8
36864	DVRbG2	1	8
36865	DVRaST3	1	8
36859	Laf300	2	8
36859	Laf300	1	8
36858	Gia100	1	7
36895	Gia200	1	7
35854	LECEFGT1	1	7
35855	LECEFGT2	1	7
35856	LECEFGT3	1	7
35857	LECEFGT4	1	7

Attachment B - Effectiveness factors for procurement guidance

35858	LECEFST1	1	7
35860	OLS-AGNE	1	7

Table – Ames/Pittsburg/Oakland

Effectiveness factors to the San Mateo-Pittsburg E 1 230 kV line:

Gen Bus	Gen Name	Gen ID	Eff Fctr. (%)
33469	OX_MTN	1	13
33469	OX_MTN	2	13
33469	OX_MTN	3	13
33469	OX_MTN	4	13
33469	OX_MTN	5	13
33469	OX_MTN	6	13
33469	OX_MTN	7	13
35304	RUSCTYECCT1	1	11
35305	RUSCTYECCT2	2	11

Effectiveness factors to the Moraga-Clairemont #2 115 kV line:

Gen Bus	Gen Name	Gen ID	Eff Fctr. (%)
32921	ChevGen1	1	25
32922	ChevGen2	1	25
32923	ChevGen3	3	25
32920	UNION CH	1	24
32910	UNOCAL	1	23
32910	UNOCAL	2	23
32910	UNOCAL	3	23
33136	CCCSD	1	20
33141	SHELL 1	1	20
33142	SHELL 2	1	20
33143	SHELL 3	1	20
32901	OAKLND 1	1	17
38118	ALMDACT1	1	17
38119	ALMDACT2	1	17

Attachment B - Effectiveness factors for procurement guidance

33102	COLUMBIA	1	16
33111	LMECCT2	1	16
33112	LMECCT1	1	16
33113	LMECST1	1	16
33107	DEC STG1	1	15
33108	DEC CTG1	1	15
33109	DEC CTG2	1	15
33110	DEC CTG3	1	15
33151	FOSTER W	1	10
33151	FOSTER W	2	10
33151	FOSTER W	3	10
35304	RUSCTYECCT1	1	4
35305	RUSCTYECCT2	2	4
35306	RUSCTYECST1	3	4
33469	OX_MTN	1	1
33469	OX_MTN	2	1
33469	OX_MTN	3	1
33469	OX_MTN	4	1
33469	OX_MTN	5	1
33469	OX_MTN	6	1
33469	OX_MTN	7	1

Table – Herndon

Effectiveness factors to the Herndon-Manchester 115 kV line:

Gen Bus	Gen Name	Gen ID	Eff Fctr. (%)
34624	BALCH 1	1	22
34616	KINGSRIV	1	21
34500	DINUBA	TA	19
34648	DINUBA E	1	19
34671	KRCDPCT1	1	19
34672	KRCDPCT2	1	19
34308	KERCKHOF	1	17
34344	KERCK1-1	1	17
34345	KERCK1-3	3	17

Attachment B - Effectiveness factors for procurement guidance

34690	CORCORAN_3	FW	15
34692	CORCORAN_4	FW	15
34677	Q558	1	15
34696	CORCORANPV_S	1	15
34610	HAAS	1	13
34610	HAAS	2	13
34612	BLCH 2-2	1	13
34614	BLCH 2-3	1	13
34431	GWF_HEP1	1	8
34433	GWF_HEP2	1	8
34617	Q581	1	5
34680	KANSAS	1	5
34467	GIFFEN_DIST	1	4
34563	STROUD_DIST	2	4
34563	STROUD_DIST	1	4
34608	AGRICO	2	4
34608	AGRICO	3	4
34608	AGRICO	4	4
34644	Q679	1	4
365502	Q632BC1	1	4

Table – LA Basin

Effectiveness factors to the San Onofre – San Luis Rey #1 230 kV line:

Gen Bus	Gen Name	Gen ID	Eff. Factor (%)
24067	HUNT2 G	LP	16
24067	HUNT2 G	HP	16
24580	HUNTBCHCTG1	G1	16
24581	HUNTBCHCTG2	G2	16
24582	HUNTBCHSTG	S1	16
25671	WH_STN_2	1	14
25670	WH_STN_1	1	14
25883	VILLAPKEQFD	EQ	13
29952	CanyonGT 2	2	13
29952	CanyonGT 3	3	13

Attachment B - Effectiveness factors for procurement guidance

29952	CanyonGT 4	4	13
29952	CanyonGT 1	1	13
24005	ALAMT5 G	5	12
24003	ALAMT3 G	LP	12
24003	ALAMT3 G	HP	12
24004	ALAMT4 G	HP	12
24004	ALAMT4 G	LP	12
25812	CHINO EQFD	EQ	12
24575	ALAMT CTG1	G1	12
24576	ALAMT CTG2	G2	12
24577	ALAMT STG	S1	12
25818	DELAMO EQFD	EQ	12
25810	CENTER EQFD	EQ	12
25523	ALMITOS B1_G	1	12
24164	ARCO 6G	6	12
24171	LBEACH34	4	12
24171	LBEACH34	3	12
24170	LBEACH12	2	12
24170	LBEACH12	1	12
24139	SERRFGEN	D1	12
25844	MIRALOM EQFD	EQ	11
24337	VENICE	1	11
25820	EL NIDO EQFD	EQ	11
25838	LA FRSA EQFD	EQ	11
25889	WALNUT EQFD	EQ	11
24122	REDON6 G	6	11
24124	REDON8 G	8	11
29902	ELSEG7GT	7	11
29904	ELSEG5GT	5	11
24062	HARBOR G	1	11
24062	HARBOR G	HP	11
29903	ELSEG6ST	6	11
25510	HARBORG4	LP	11
29901	ELSEG8ST	8	11
24241	MALBRG3G	S3	11

Attachment B - Effectiveness factors for procurement guidance

24240	MALBRG2G	C2	11
24239	MALBRG1G	C1	11
25842	MESACAL EQFD	EQ	11
29205	WALCRKG5	1	11
29204	WALCRKG4	1	11
29203	WALCRKG3	1	11
29202	WALCRKG2	1	11
29201	WALCRKG1	1	11
25849	NEWMARK FD1	EQ	11
25857	RIOHNDQ EQFD	EQ	11
25851	PADUA EQFD	EQ	11
25042	PASADNA3	1	10
25043	PASADNA4	1	10
25822	ETIWNDA EQFD	EQ	10
25422	ETI MWDG	1	10
29013	GLENARM5_CT	CT	10
25885	VSTAEQFD	EQ	10
29014	GLENARM5_ST	ST	10
29594	VSTA_EQFD	EQ	10
25603	DVLCYN3G	3	9
25604	DVLCYN4G	4	9
25659	MJVSPHN3	3	9
25658	MJVSPHN2	2	9
25657	MJVSPHN1	1	9
24300	RERC2G4	1	9
24299	RERC2G3	1	9
24243	RERC2G	1	9
24242	RERC1G	1	9
25648	DVLCYN1G	1	9
25649	DVLCYN2G	2	9
25861	SNBRDNO EQFD	EQ	9
25863	SNBRDNO FD1	EQ	9
24921	MNTV-G3A	1	9
24922	MNTV-G3B	1	9
24923	MNTV-ST3	1	9

Attachment B - Effectiveness factors for procurement guidance

24924	MNTV-G4A	1	9
25872	VALLEYS EQFD	EQ	9
25846	WDT786G	EQ	9
100712	CABAZON_WND	1	8
25634	BUCKWND	W5	7
25634	BUCKWND	QF	7
25646	SANWIND	Q1	7
25645	VENWIND	EU	7
25645	VENWIND	Q2	7
25645	VENWIND	Q1	7
25646	SANWIND	Q2	7
25636	RENWIND	Q1	7
24815	GARNET	QF	7
24815	GARNET	W2	7
24815	GARNET	W3	7
24815	GARNET	G2	7
24815	GARNET	G3	7
24815	GARNET	G1	7
24815	GARNET	PC	7
25636	RENWIND	Q2	7
25639	SEAWIND	QF	7
25637	TRANWND	QF	7
25640	PANAERO	QF	7
25827	GARNET FD	EQ	7
29021	WNTEC6	1	7
25677	WHITEWTR	1	7
25834	HIDSRF FD	EQ	7
25833	WDT458G	EQ	7
698105	ALTWNDGEN1	1	7
29069	MOUNTWND_3G	1	7
29049	BLAST_G	1	7
29290	CABAZON_G	1	7
698106	ALTWNDGEN2	1	7
29066	MOUNTWND_2G	1	7
29107	SENTINEL_G7	1	7

Attachment B - Effectiveness factors for procurement guidance

29103	SENTINEL_G3	1	7
29102	SENTINEL_G2	1	7
29105	SENTINEL_G5	1	7
29106	SENTINEL_G6	1	7
29108	SENTINEL_G8	1	7
29104	SENTINEL_G4	1	7
29101	SENTINEL_G1	1	7
29064	MOUNTWND_1G	1	7
25633	CAPWIND	QF	6

Effectiveness factors to the Mesa – Laguna Bell #1 230 kV line:

Gen Bus	Gen Name	Gen ID	Eff Fctr. (%)
29951	REFUSE	D1	35
24239	MALBRG1G	C1	34
24240	MALBRG1G	C2	34
24241	MALBRG1G	S3	34
29903	ELSEG6ST	6	27
29904	ELSEG5GT	5	27
29902	ELSEG7ST	7	27
29901	ELSEG8GT	8	27
24337	VENICE	1	26
24094	MOBGEN1	1	26
24329	MOBGEN2	1	26
24332	PALOGEN	D1	26
24011	ARCO 1G	1	23
24012	ARCO 2G	2	23
24013	ARCO 3G	3	23
24014	ARCO 4G	4	23
24163	ARCO 5G	5	23
24164	ARCO 6G	6	23
24062	HARBOR G	1	23
24062	HARBOR G	HP	23
25510	HARBORG4	LP	23
24327	THUMSGEN	1	23

Attachment B - Effectiveness factors for procurement guidance

24020	CARBGEN1	1	23
24328	CARBGEN2	1	23
24139	SERRFGEN	D1	23
24070	ICEGEN	1	22
24001	ALAMT1 G	1	18
24002	ALAMT2 G	2	18
24003	ALAMT3 G	3	18
24004	ALAMT4 G	4	18
24005	ALAMT5 G	5	18
24161	ALAMT6 G	6	18
90000	ALMT-GT1	X1	18
90001	ALMT-GT2	X2	18
90002	ALMT-ST1	X3	18
29308	CTRPKGEN	1	18
29953	SIGGEN	D1	18
29309	BARPKGEN	1	13
29201	WALCRKG1	1	12
29202	WALCRKG2	1	12
29203	WALCRKG3	1	12
29204	WALCRKG4	1	12
29205	WALCRKG5	1	12
29011	BREAPWR2	C1	12
29011	BREAPWR2	C2	12
29011	BREAPWR2	C3	12
29011	BREAPWR2	C4	12
29011	BREAPWR2	S1	12
24325	ORCOGEN	1	12
24341	COYGEN	1	11
25192	WDT1406_G	1	11
25208	DowlingCTG	1	10
25211	CanyonGT 1	1	10
25212	CanyonGT 2	2	10
25213	CanyonGT 3	3	10
25214	CanyonGT 4	4	10
24216	VILLA PK	DG	9

Attachment B - Effectiveness factors for procurement guidance

Table – Rector

Effectiveness factors to the Rector-Vestal 230 kV line:

Gen Bus	Gen Name	Gen ID	MW Eff Fctr (%)
24370	KAWGEN	1	51
24306	B CRK1-1	1	45
24306	B CRK1-1	2	45
24307	B CRK1-2	3	45
24307	B CRK1-2	4	45
24319	EASTWOOD	1	45
24323	PORTAL	1	45
24308	B CRK2-1	1	45
24308	B CRK2-1	2	45
24309	B CRK2-2	3	45
24309	B CRK2-2	4	45
24310	B CRK2-3	5	45
24310	B CRK2-3	6	45
24315	B CRK 8	81	45
24315	B CRK 8	82	45
24311	B CRK3-1	1	45
24311	B CRK3-1	2	45
24312	B CRK3-2	3	45
24312	B CRK3-2	4	45
24313	B CRK3-3	5	45
24317	MAMOTH1G	1	45
24318	MAMOTH2G	2	45
24314	B CRK 4	41	43
24314	B CRK 4	42	43

Table – San Diego

Effectiveness factors to the Sycamore – Suncrest 230 kV line:

Gen Bus	Gen Name	Gen ID	Eff. Factor (%)
23929	Q1669_ES	12	24

Attachment B - Effectiveness factors for procurement guidance

22124	CHCARITA	1	23
22487	MEF MR2	1	23
22486	MEF MR1	1	23
22120	CARLTNHS	1	23
22120	CARLTNHS	2	23
22915	KUMEYAAY	1	23
23871	Q1662_ES	12	22
22208	EL CAJON	1	22
23320	EC GEN2	1	22
23560	Q1047_BESS	1	22
23412	Q1434_G	10	22
22150	EC GEN1	1	22
22204	EASTGATE	1	22
22625	LkHodG1	1	22
22626	LkHodG2	1	22
22448	MESAHGTS	1	22
22496	MISSION	1	22
22092	CABRILLO	1	22
23933	Q1670_ES	12	22
22870	VALCNTR	59	22
22704	SAMPSON	1	22
22333	GOALLINE GEN	1	22
22333	GOALLINE GEN	2	22
23628	Q1191_G2	1	22
22074	LRKSPBD1	1	22
22075	LRKSPBD2	1	22
22604	OTAY	3	22
22604	OTAY	1	22
22617	OY GEN	1	22
22262	PEN_CT1	1	22
22149	CALPK_BD	1	21
22153	CALPK_ES	1	21
22257	ES GEN	1	21
22256	ESCNDIDO	12	21
22256	ESCNDIDO	11	21
22256	ESCNDIDO	10	21

Attachment B - Effectiveness factors for procurement guidance

23685	Q1045_GEN	C7	21
22263	PEN_CT2	1	21
22265	PEN_ST	1	21
23557	Q1048_BESS	C7	21
22724	SANMRCOS	1	21
22789	EA GEN1 U10	1	21
22783	EA GEN1 U8	1	20
22784	EA GEN1 U9	1	20
22786	EA GEN1 U6	1	20
22787	EA GEN1 U7	1	20
22628	PA GEN1	1	20
22629	PA GEN2	1	20
22606	OTAYMGT2	1	20
22605	OTAYMGT1	1	20
22607	OTAYMST1	1	20
23544	Q1169_BESS1	1	19
23162	PIO PICO 1A	1	19
23163	PIO PICO 1B	1	19
23164	PIO PICO 1C	1	19
23519	Q1169_BESS2	1	19
23841	Q1657_ES	12	17
22112	CAPSTRNO	1	17

Effectiveness factors to the Imperial Valley – El Centro 230 kV line (i.e., the “S” line):

Gen Bus	Gen Name	Gen ID	Eff Fctr. (%)
22982	TDM CTG2	1	25
22983	TDM CTG3	1	25
22981	TDM STG	1	25
22997	INTBCT	1	25
22996	INTBST	1	25
23440	DW GEN2 G1	1	25
23298	DW GEN1 G1	G1	25
23156	DU GEN1 G2	G2	25
23299	DW GEN1 G2	G2	25

Attachment B - Effectiveness factors for procurement guidance

23155	DU GEN1 G1	G1	25
23441	DW GEN2 G2	1	25
23442	DW GEN2 G3A	1	25
23443	DW GEN2 G3B	1	25
23314	OCO GEN G1	G1	23
23318	OCO GEN G2	G2	23
23100	ECO GEN1 G	G1	22
23352	ECO GEN2 G	1	21
22605	OTAYMGT1	1	18
22606	OTAYMGT2	1	18
22607	OTAYMST1	1	18
23162	PIO PICO CT1	1	18
23163	PIO PICO CT2	1	18
23164	PIO PICO CT3	1	18
22915	KUMEYAAY	1	17
23320	EC GEN2	1	17
22150	EC GEN1	1	17
22617	OY GEN	1	17
22604	OTAY	1	17
22604	OTAY	3	17
22172	DIVISION	1	17
22576	NOISLMTR	1	17
22704	SAMPSON	1	17
22092	CABRILLO	1	17
22074	LRKSPBD1	1	17
22075	LRKSPBD2	1	17
22660	POINTLMA	1	17
22660	POINTLMA	2	17
22149	CALPK_BD	1	17
22448	MESAHGTS	1	16
22120	CARLTNHS	1	16
22120	CARLTNHS	2	16
22496	MISSION	1	16
22486	MEF MR1	1	16
22124	CHCARITA	1	16
22487	MEF MR2	1	16

Attachment B - Effectiveness factors for procurement guidance

22625	LkHodG1	1	16
22626	LkHodG2	2	16
22332	GOALLINE	1	15
22262	PEN_CT1	1	15
22153	CALPK_ES	1	15
22786	EA GEN1 U6	1	15
22787	EA GEN1 U7	1	15
22783	EA GEN1 U8	1	15
22784	EA GEN1 U9	1	15
22789	EA GEN1 U10	1	15
22257	ES GEN	1	15
22263	PEN_CT2	1	15
22265	PEN_ST	1	15
22724	SANMRCOS	1	15
22628	PA GEN1	1	14
22629	PA GEN2	1	14
22082	BR GEN1	1	14
22112	CAPSTRNO	1	12