



2023 & 2027 Draft LCR Study Results Kern Area

Preethi Rondla

Regional Transmission Engineer

Stakeholder Call

March 9, 2022

Kern Area LCR Sub-Areas

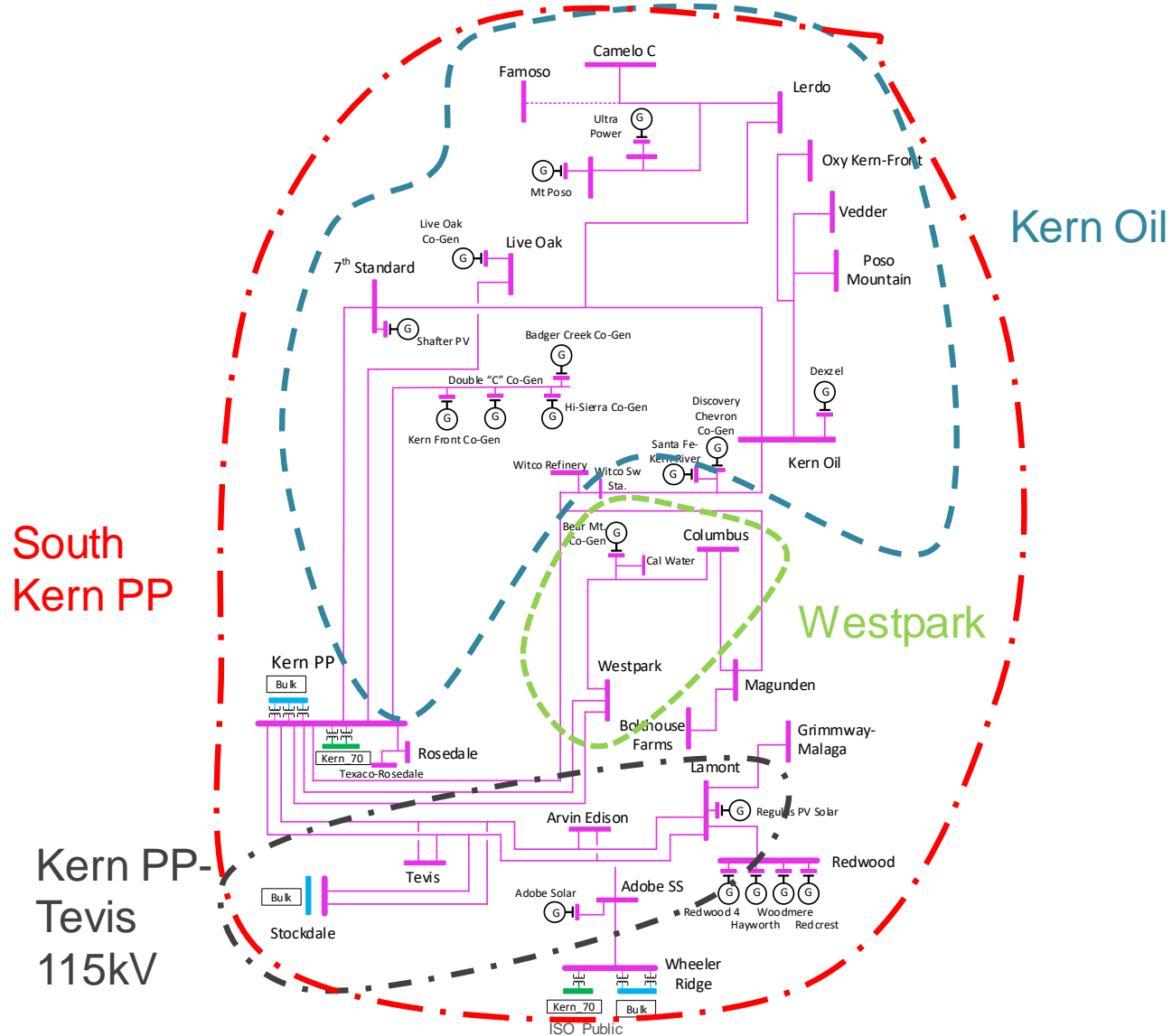

Major new projects

Project Name	Expected ISD
Midway-Temblor 115 kV Line Reconductor & Voltage Support	October-2027
Bakersfield Nos. 1 and 2 230 kV Tap Lines Reconductoring	August-2027
Kern PP 115 kV Area Reinforcement	July- 2027
Wheeler ridge Junction Station Project	ON HOLD

Kern Area Overall: Load and Resources

Load (MW)	2023	2027	Generation (MW)	2023	2027
Gross Load	937	945	Market/ Net Seller/ Battery	351	351
AAEE	-5	-8	Solar	73	73
Behind the meter DG	0	0	Wind	0	0
Net Load	932	937	Muni	0	0
Transmission Losses	8	8	QF	6	6
Pumps	0	0	Future preferred resource and energy storage	0	0
Load + Losses + Pumps	940	945	Total Qualifying Capacity	430	430

Kern Area LCR

Westpark Sub-Area

Year	Category	Limiting Facility	Contingency	LCR (MW) (Deficiency)
2023	P2	Kern-Westpark #2 115 kV	KERN PWR 115kV - Section 1E & 1D	10
2027	P2	Kern-Westpark #2 115 kV	KERN PWR 115kV - Section 1E & 1D	10

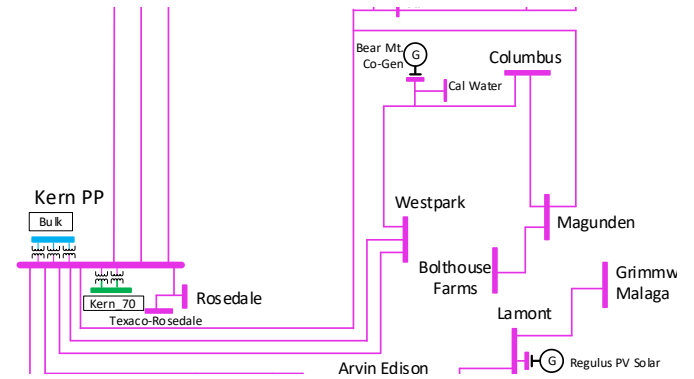

Westpark Subarea: Load Profiles

Kern - Westpark LCR Subarea:
 2023 projected pk day load profile & approx. LSC (trans + LCR Gen + ES)
 Approx storage size that can be added to this area from charging restriction perspective =
 10 MWh and 50 MWh. Max 4-hr storage = 4 MW

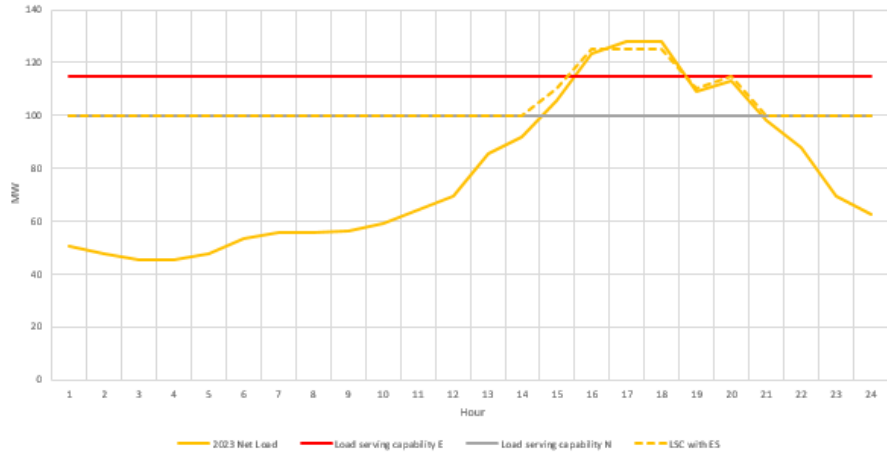

Kern - Westpark LCR Subarea:
 2023 projected load profile & approx. load serving capability (transmission only)

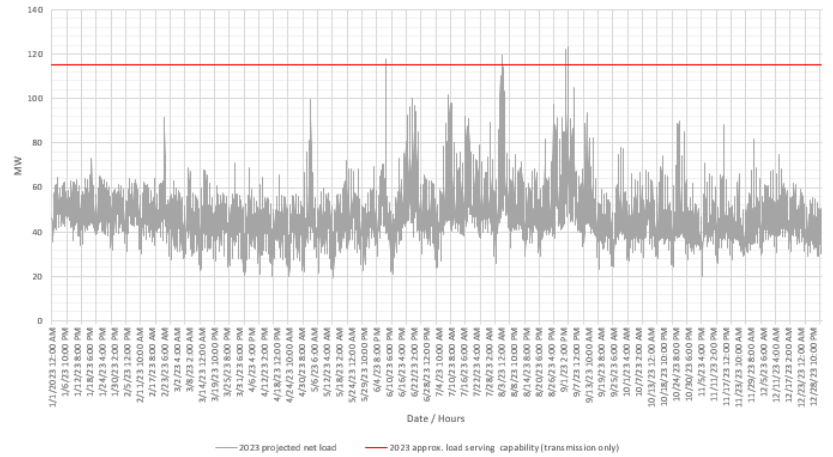

Kern - Westpark LCR Subarea:
 2027 projected pk day load profile & approx. LSC (trans + LCR Gen + ES)
 Approx storage size that can be added to this area from charging restriction perspective =
 10 MWh and 50 MWh. Max 4-hr storage = 6 MW

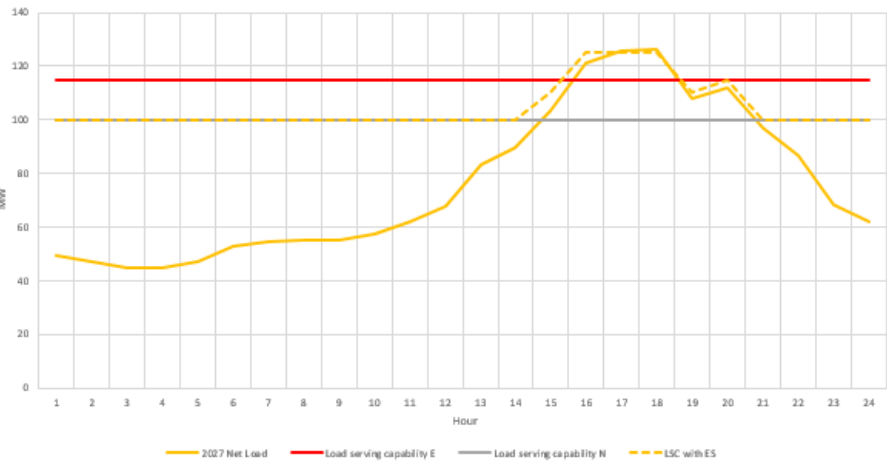

Kern - Westpark LCR Subarea:
 2027 projected load profile & approx. load serving capability (transmission only)

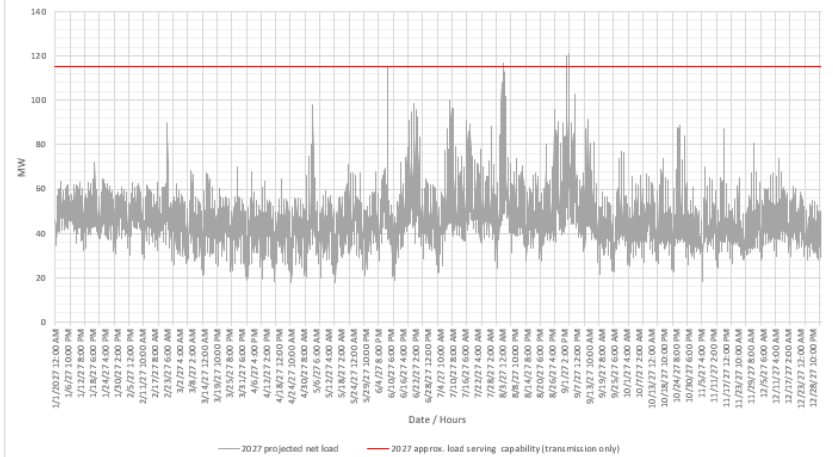

Kern Area LCR

Kern Oil Sub-Area

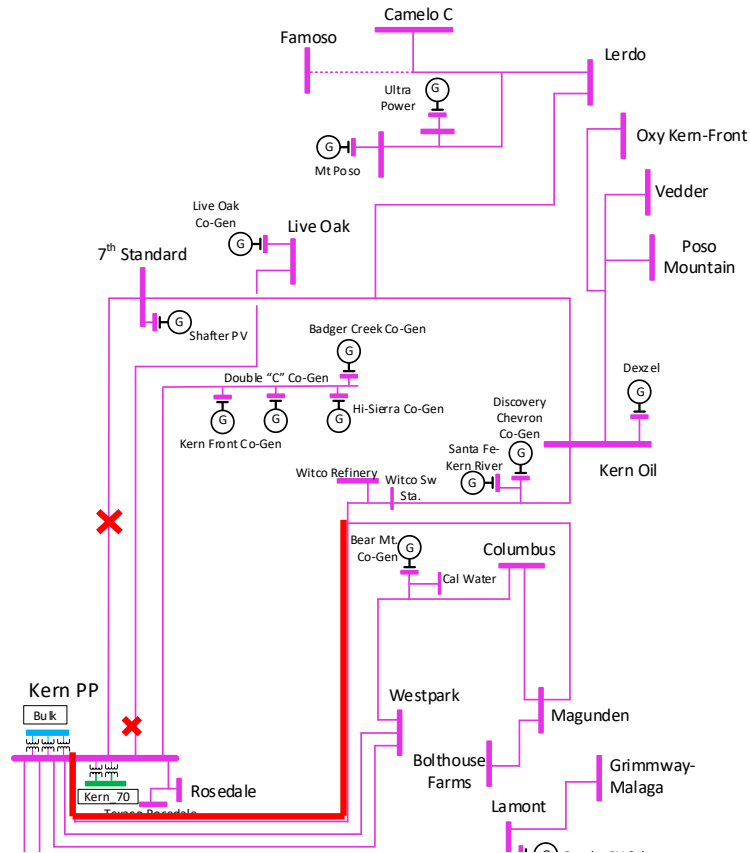

Kern Area LCR

Kern Oil Sub-Area

Year	Cat	Limiting Facility	Contingency	LCR (MW) (Deficiency)
2023	P6	Kern Oil - Kern Water 115 kV Line	Kern PP-7th Standard 115 kV lines & Kern PP-Live Oak 115 kV Line	60

Year	Cat	Limiting Facility	Contingency	LCR (MW) (Deficiency)
2027	P6	Kern Oil - Kern Water 115 kV Line	Kern PP-7th Standard 115 kV lines & Kern PP-Live Oak 115 kV Line	70

Kern Oil Subarea: Load Profiles

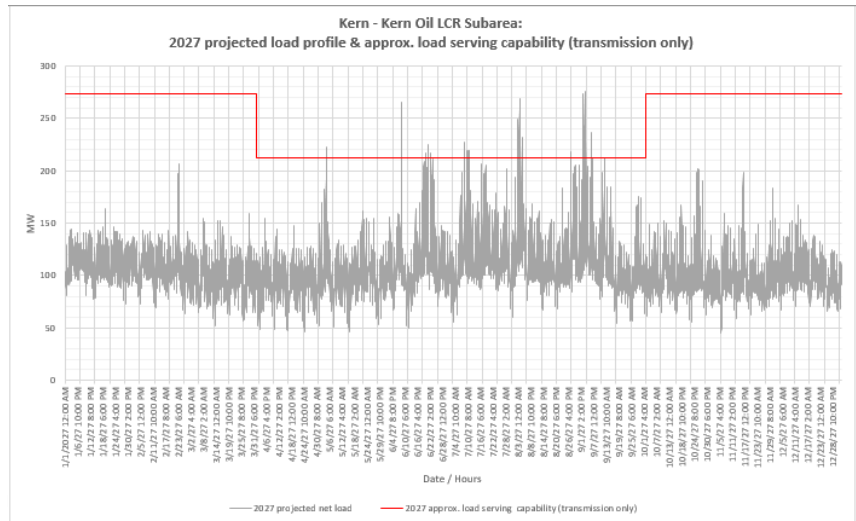
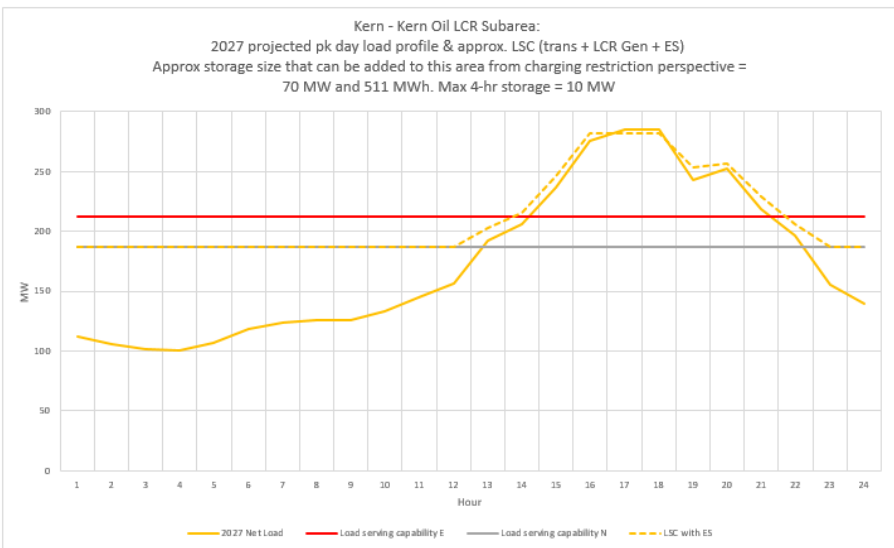
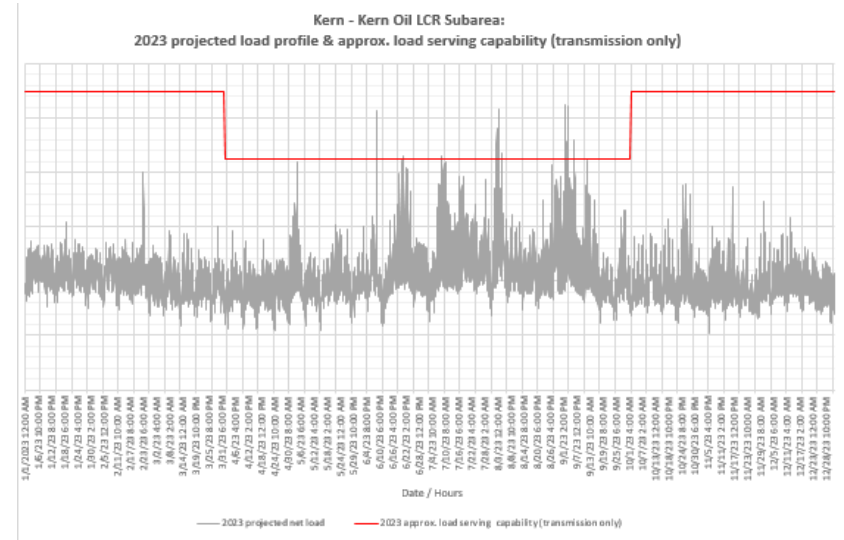
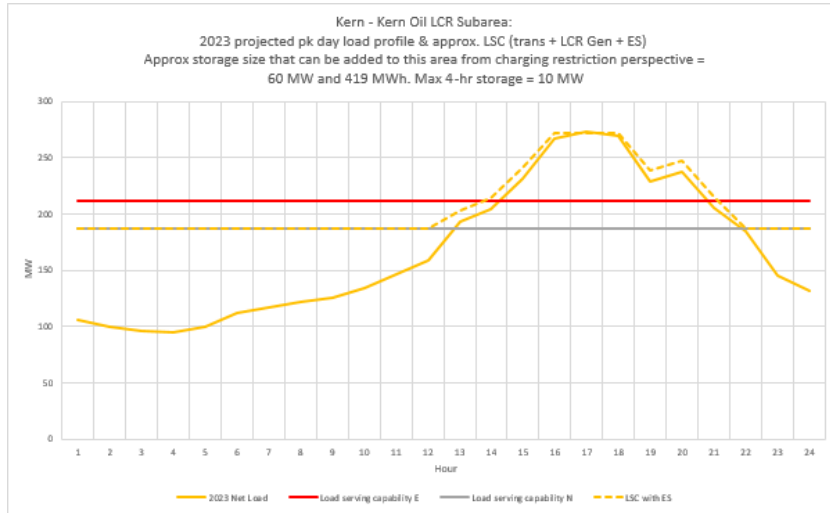

Kern Pwr-Tevis 115 kV Sub-Area : Requirements

Year	Category	Limiting Facility	Contingency	LCR (MW) (Deficiency)
2023	P2	Kern-Lamont 115 kV Lines (Kern-Tevis Jct 2/Tevis J1)	KERN PWR 115kV - Section 1E & 1D	0
2027	P2	Kern-Lamont 115 kV Lines (Kern-Tevis Jct 2/Tevis J1)	KERN PWR 115kV - Section 1E & 1D	0

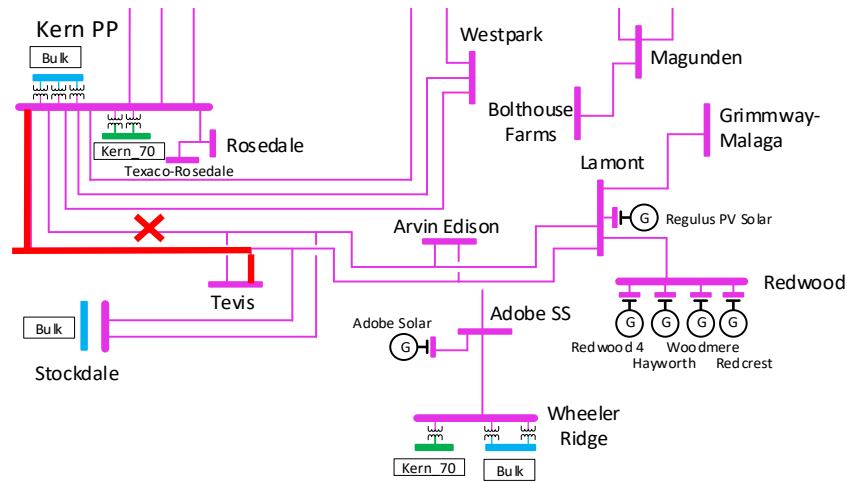

Kern Area LCR

South Kern PP Sub-Area

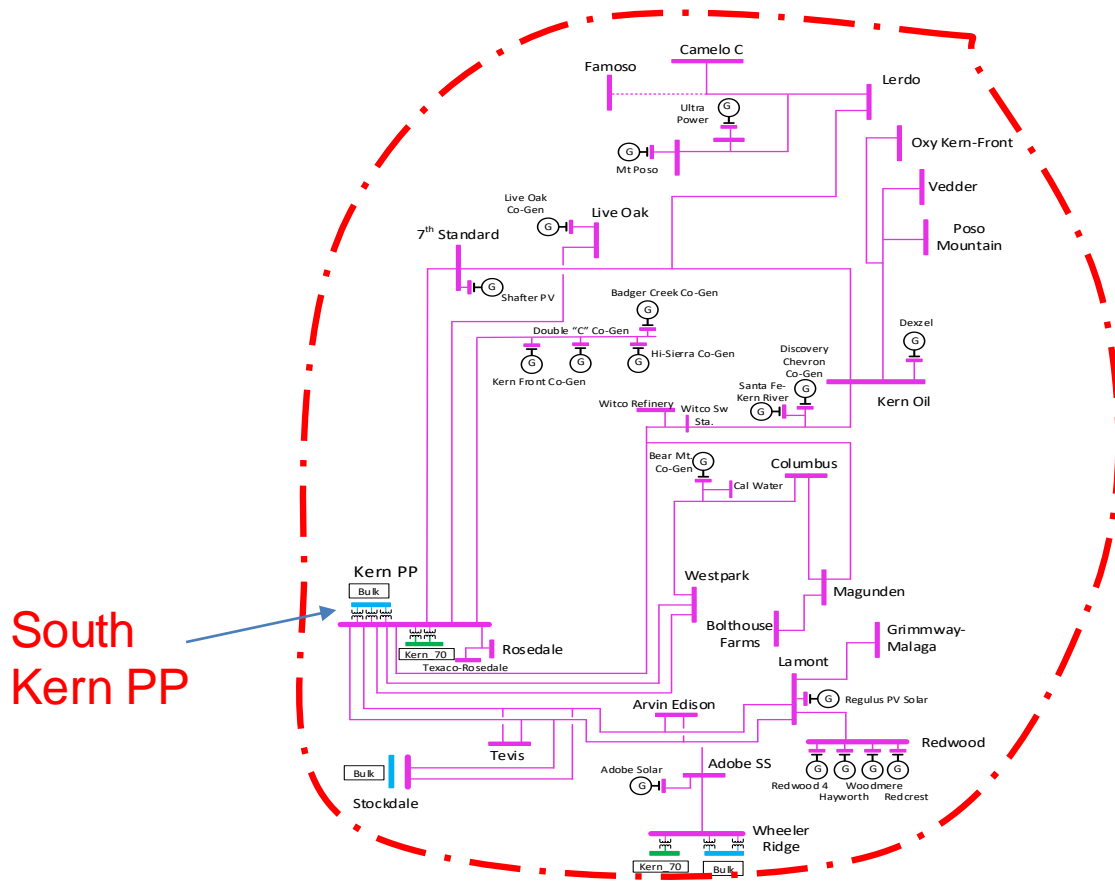

Kern Area LCR

South Kern PP Sub-Area

Year	Cat	Limiting Facility	Contingency	LCR (MW) (Deficiency)
2023	P7	Kern PP - Stockdale Junction 1 230 kV Line	Midway - Kern 230 kV Line #3 and Midway - Kern 230 kV Line #1	443 (13 NQC) (86 Peak)

Year	Cat	Limiting Facility*	Contingency	LCR (MW) (Deficiency)
2027	P7	Midway - Bakersfield B 230 kV Line*	Midway - Kern 230kV Line #3 and Midway - Kern 230kV Line #4	320

Note: The Midway - Bakersfield B 230 kV line rating in base case is high however the reconductoring project, to increase this rating, will not be in-service until August 2027 and therefore for the 2027 LCR studies we have used the lower pre-reconductoring ratings.

South Kern PP Subarea: Load Profiles

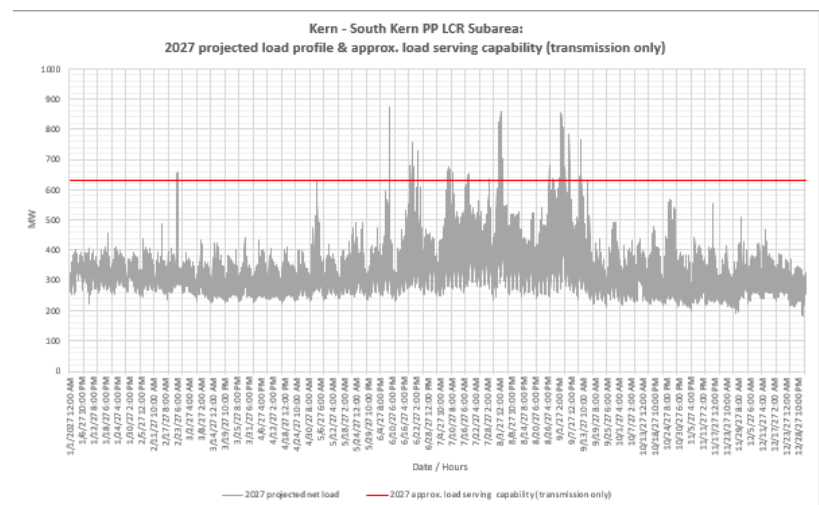
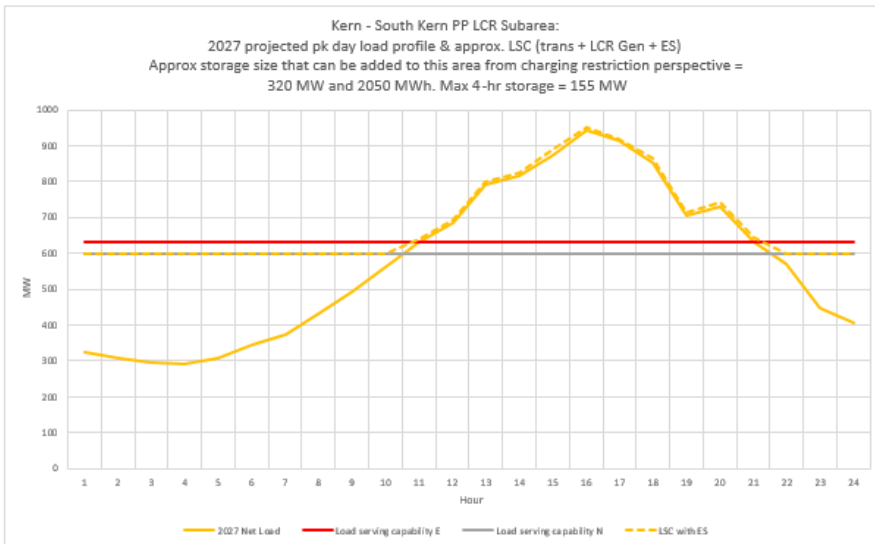
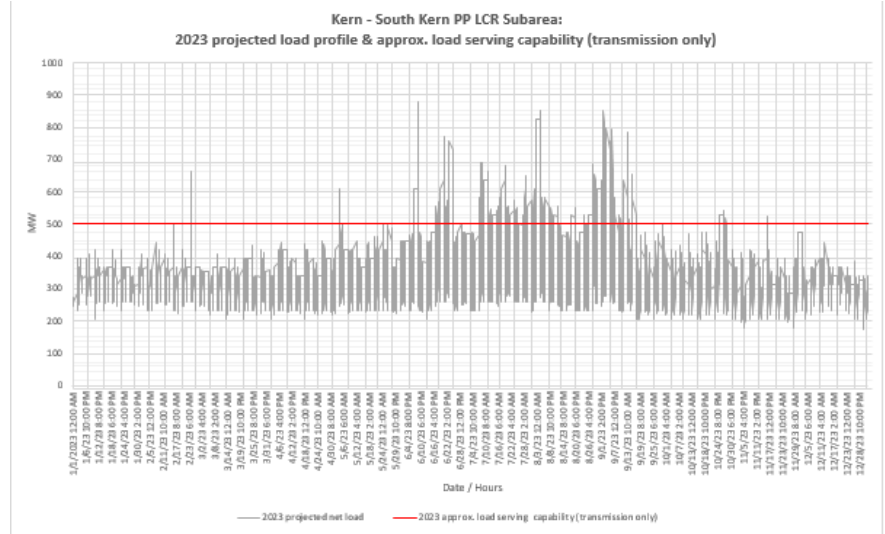
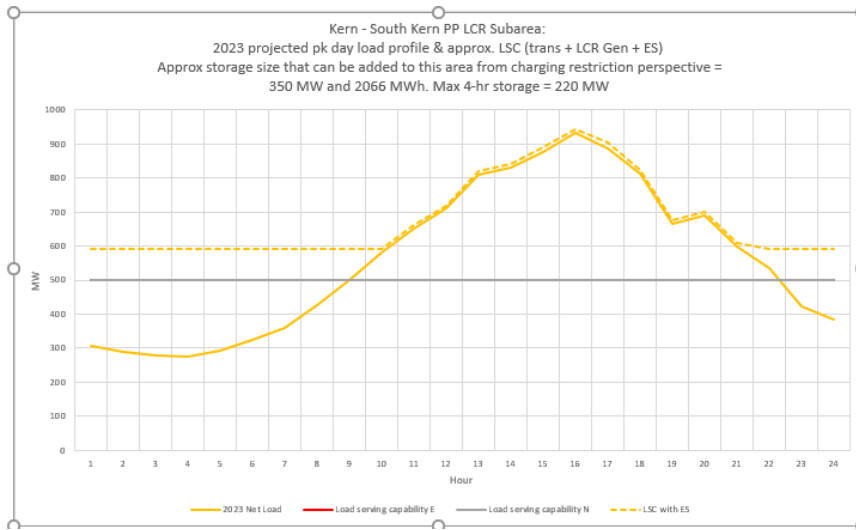

Kern Total LCR Need

2023 LCR Need	Existing Generation Capacity Needed (MW)	NQC Deficiency (MW)	Total MW Need
Category P7	430	13	443

2027 LCR Need	Existing Generation Capacity Needed (MW)	NQC Deficiency (MW)	Total MW Need
Category P7	320	0	320

Changes Compared to Previous LCR Requirements

Sub-area	2022		2023		2026		2027	
	Net Load	LCR	Net Load	LCR	Net Load	LCR	Net Load	LCR
Westpark	140	53 (9 NQC)	126	10	147	51 (7 NQC)	125	10
Kern Oil	276	78	269	60	283	84	285	70
KernPP- Tevis 115 kV	158	22 (22 Peak)	149	0	164	26 (26 Peak)	150	0
South Kern	1019	356 (23 Peak)	932	443 (86 Peak 13 NQC)	1056	432 (95 Peak 14 NQC)	937	320
Kern Overall	1019	365 (9 NQC)	932	443 (86 Peak 13 NQC)	1056	432 (14 NQC)	937	320

The increase in 2023 LCR need is mostly due to more restrictive contingency, limiting element identified for South Kern area, except for reduction in Tevis and Westpark sub-areas due to load reduction.

The decrease in 2027 LCR need is mostly due to load forecast drop for South Kern sub-area.