



# Regional Integration - California Greenhouse Gas Compliance Initiative

Don Tretheway

Sr. Advisor, Market Design and Regulatory Policy

Technical Workshop

October 13, 2016

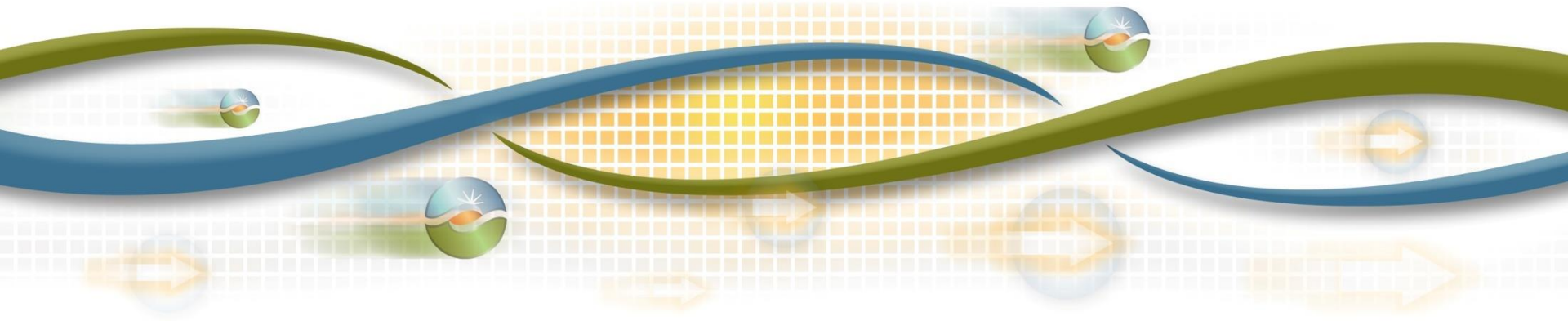

# Agenda

Time	Topic	Presenter
10:00 – 10:10	Introduction	Kristina Osborne
10:10 – 12:00	Regional GHG Account and Solution Options	Don Tretheway
12:00 – 1:00	Lunch	
1:00 – 2:30	Regional GHG Account and Solution Options	Don Tretheway
2:30 – 2:50	Multi-State BAA Implications	Don Tretheway
2:50 – 3:00	Next Steps	Kristina Osborne

# ISO Policy Initiative Stakeholder Process

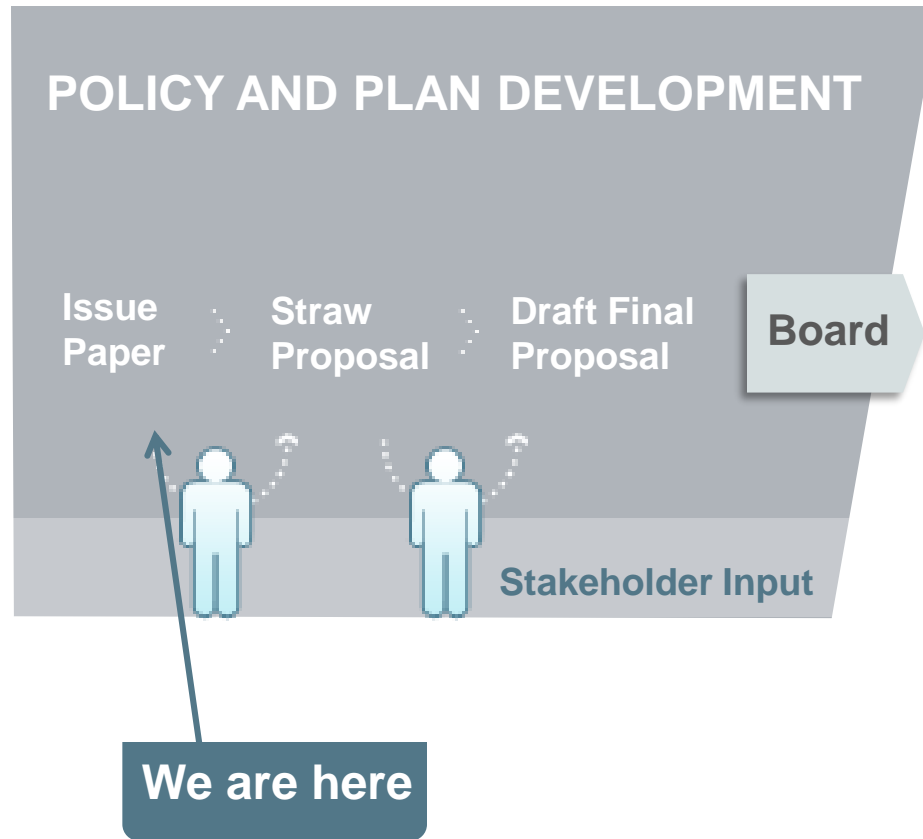

# All of these can contribute to optimal dispatch across the EIM footprint

1. EIM BAA load
2. EIM non-participating resources
3. EIM participating resources w/o a GHG bid
4. EIM participating resources w/ GHG
5. ISO load
6. ISO resources

The EIM optimization does not solve to meet imbalances, it re-dispatches the entire system

- Market optimization balances supply and demand
- Market optimization does not balance delta supply and delta demand
- Market optimization minimizes total production cost while resolving congestion
- If load is lower, what resource is incrementally dispatched to support a transfer?

# Observations of EIM dispatch optimization

- Least cost dispatch can have effect of sending low emitting resources to ISO, while not accounting for secondary dispatch of other resource to serve external demand
- Least cost dispatch can result in avoided curtailment of ISO renewables by displacing emitting resources to serve external demand

# Addressing CARB's concern to account for atmospheric effects of EIM's least cost dispatch

- ISO is working with CARB through its stakeholder process to address GHG accounting concerns of current EIM design
- Must assess if the EIM solution is scalable to day-ahead for a multi-state balancing authority area

Let's add economics to the "secondary dispatch" example. This is pre-EIM dispatch.

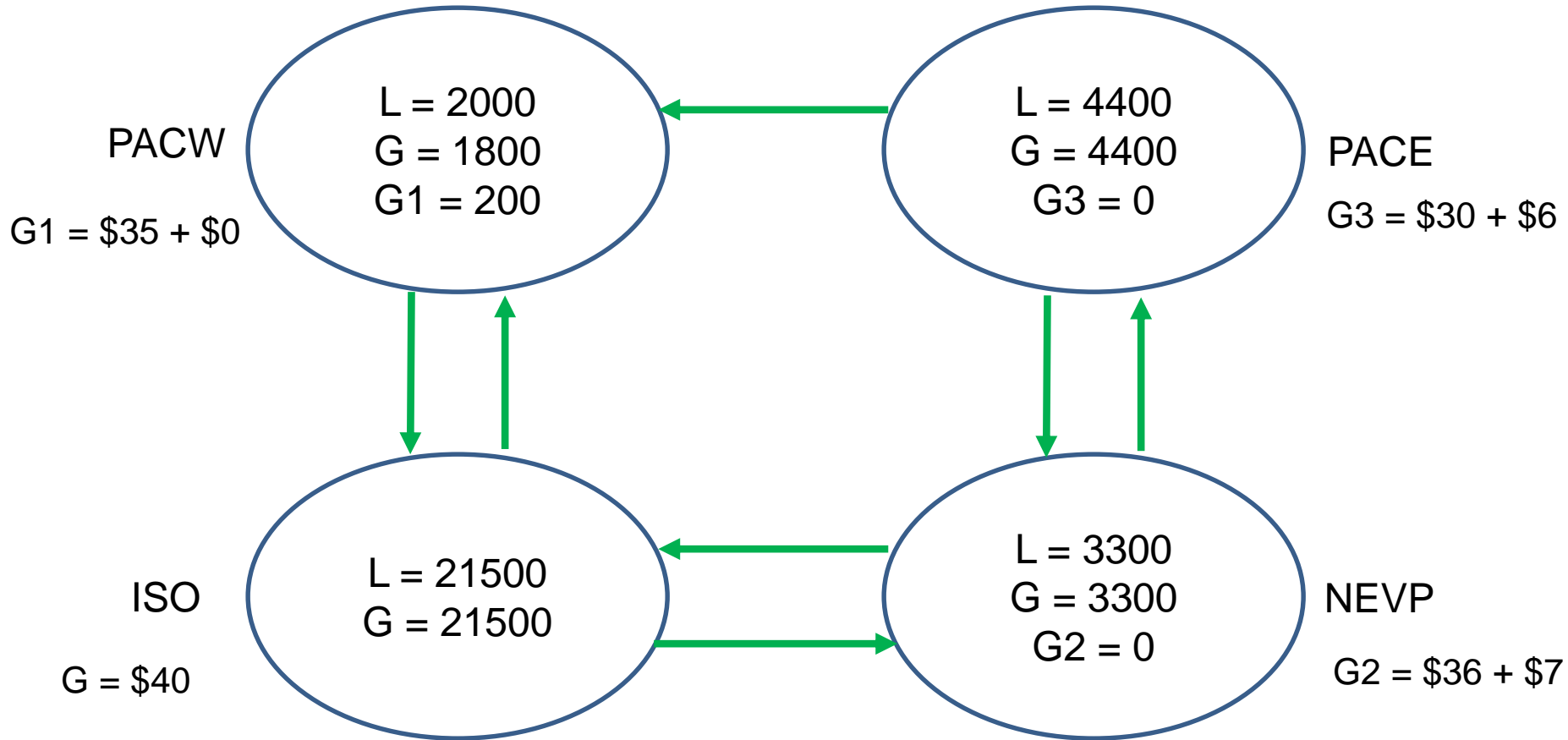

EIM Generator = Energy Bid + GHG Bid

G1-G3 PMin 0 MW, PMax = 200 MW  
 GHG MW for all is 200 MW  
 Transfer limit into ISO is 200 MW



# Let's solve the market for the EIM footprint

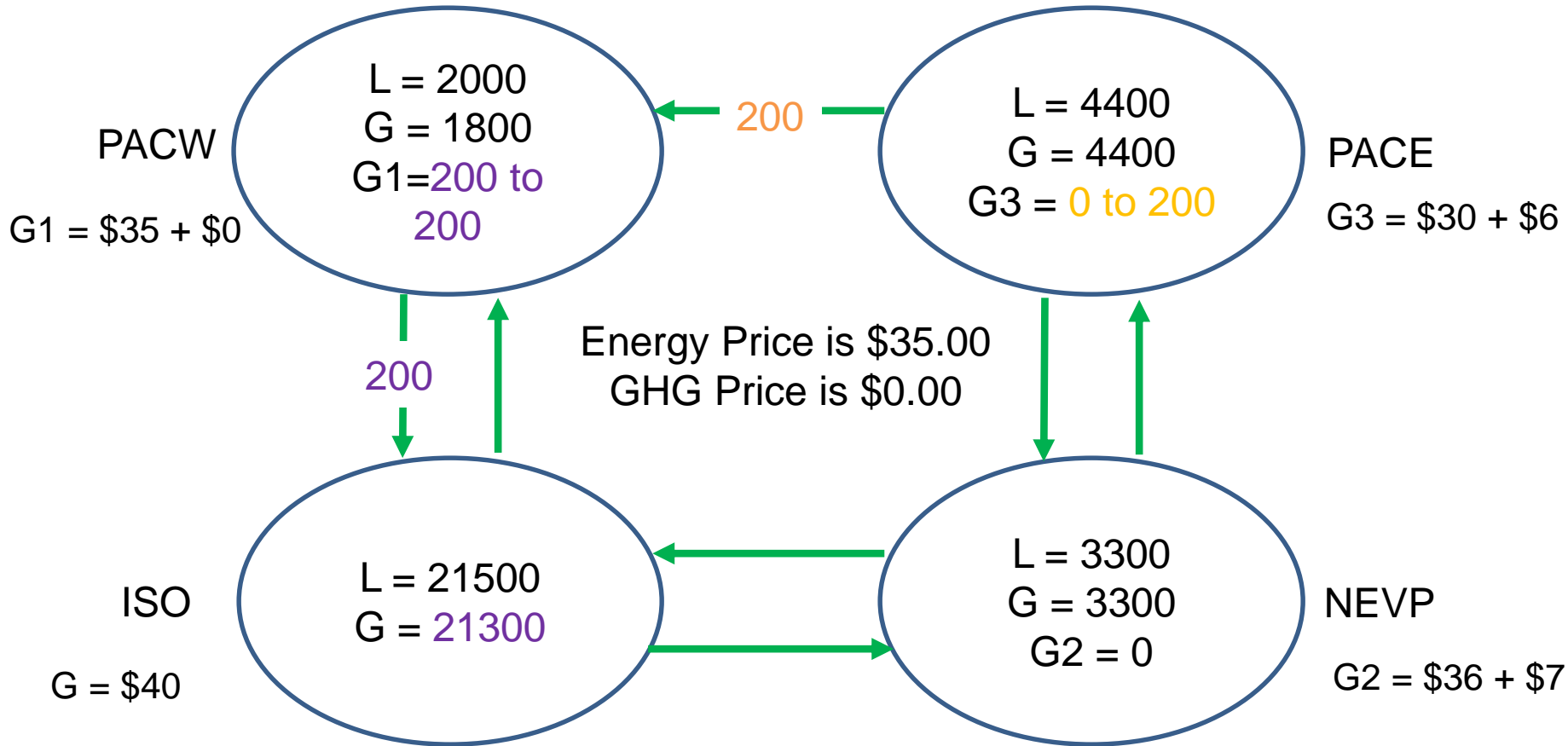

Is this an example of “secondary dispatch” because the base schedule of G1 is attributed to ISO?

Now let's assume the EIM entities optimized their base schedules before including the ISO

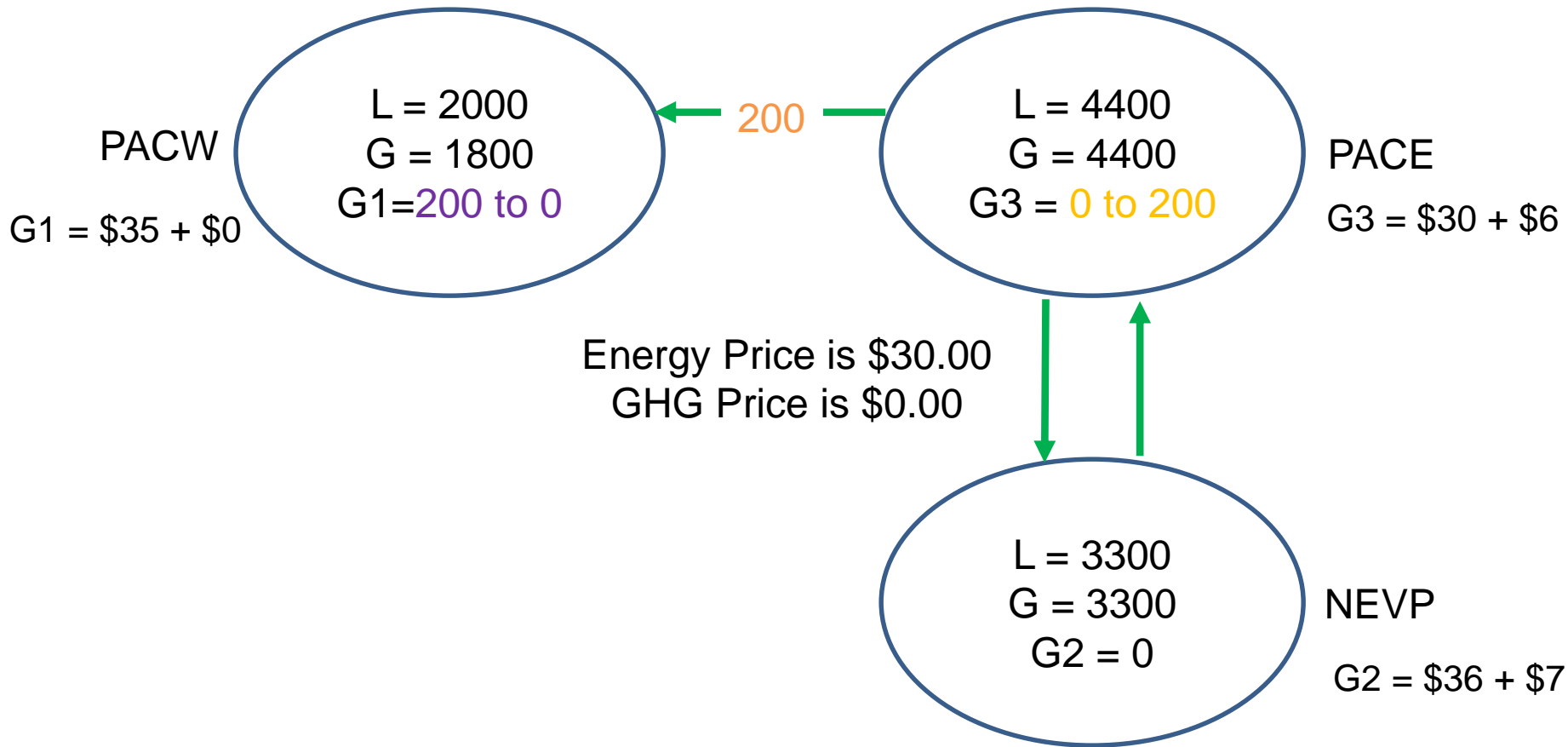

G3 is increased since it is lower cost that G1 which is reduced.  
LMP outside the ISO is \$30

# Now lets optimize from the prior slide's starting point and include the ISO

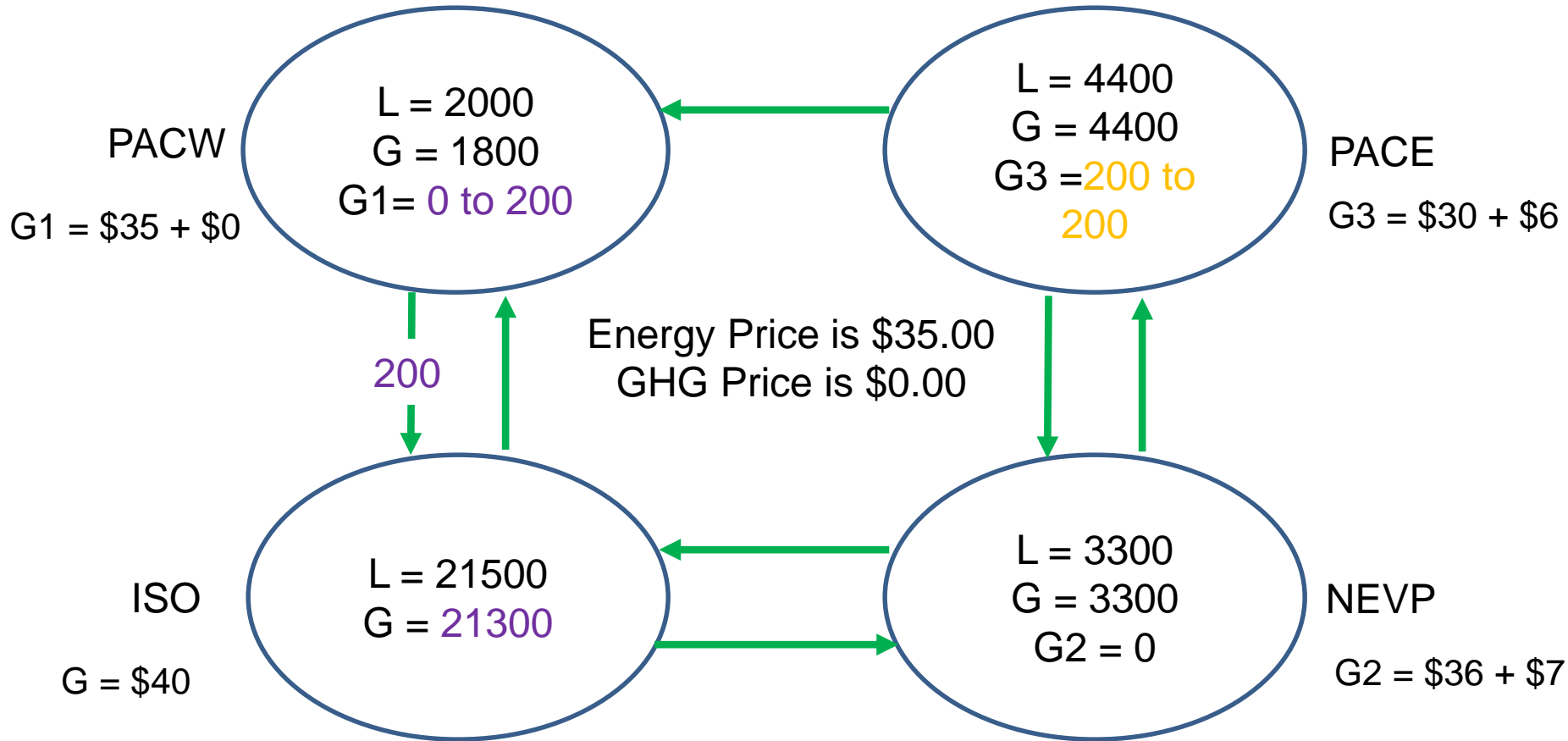

LMP in ISO is \$35. LMP outside ISO is \$35.

# Key takeaways

- Cannot assume base schedules are optimal before start of the EIM
  - Re-dispatch for economics or congestion independent of meeting a transfer to the ISO
- Resource attribution to a base schedule does not always have a secondary dispatch effect
- If a resource would have been dispatched down economically outside of the ISO, it shouldn't be a “secondary dispatch” when then used to meet ISO load

# An incremental dispatch approach **above submitted (not optimized)** base schedules can distort prices

	MIN	MAX	Energy Bid	GHG Bid MW	GHG Bid Price	Dispatch	Incremental Export Allocation	Base Export Allocation	GHG Award <= Bid
G1 (CAISO)	0	300	\$ 40.00			50.0			
G2 (EIM BAA #1)	0	125	\$ 25.00	10	\$ 11.00	10.0	10.0	0.0	NO
G3 (EIM BAA #1)	0	250	\$ 24.00	10	\$ 11.00	110.0	10.0	0.0	YES
G4 (EIM BAA #2)	0	50	\$ 27.00	50	\$ 11.00	30.0	0.0	30.0	YES
G5 (EIM BAA #2)	10	250	\$ 20.00	50	\$ 5.00	150.0	50.0	0.0	YES
G6 (EIM BAA #2)	0	300	\$ 20.00	50	\$ 5.00	75.0	50.0	0.0	YES
G7 (EIM BAA #2)	0	75	\$ 15.00	0	\$ -	25.0	0.0	0.0	YES
GHG Allocator Resource	N/A	N/A	N/A	30.0	\$ 11.00	N/A	30.0		YES
L1	200	200				200.0			
L2	100	100				100.0			
L3	150	150				150.0			
CISO to/from EIM #1	-80	150				150.0			
EIM #2 to/from EIM #1	-100	100				-100.0			
Total Allocation							150		

Look at G7 – lowest cost resource, but not dispatched to Pmax!!

Because, optimization creates incremental dispatch on higher priced EIM resources to lower cost to serve ISO load which lowers overall system cost.

# Need to consider the following when evaluating approaches to address secondary dispatch

## Principles

- Participation outside CAISO is voluntary
- GHG costs cannot impact external prices when EIM transfers into CAISO
- Comparable compliance obligation for internal resources and voluntary external resources

## Implementation

- Complexity, feasibility and timing
- Consistency between day-ahead and real-time market
- Scalability to multi-state balancing authority area
- Impact on carbon emissions of ISO dispatch

## Three top options have been considered to ensure EIM/regional GHG accounts for secondary dispatch effects

1. Calculate overall GHG impact based on comparison to counter-factual dispatch outside the market optimization
2. Modify ISO optimization, but maintain resource specific cost and attribution
3. Modify ISO optimization, residual emission rate for EIM transfers into ISO. No resource attribution of residual emissions.

## Option 1 - Calculate overall GHG impact based on comparison to counter-factual dispatch outside the market optimization

- No changes to ISO market optimization
- Create balancing account for a period of time
- ISO calculates the counterfactual over a period of time
- If time period's emissions greater than EIM resource attribution, then CARB retires instruments
- If time period's emissions less than EIM resource attribution, then CARB makes no changes

But, CARB regulation does not recognize intertemporal benefits



## Option 2 - Modify optimization, but maintain resource specific cost and attribution (1 of 2)

- Goal: GHG award only if the resource is incrementally dispatched above new “economic base” to support EIM transfer into ISO
- Submitted base schedules are used for imbalance settlement solely and are not optimized outside of CA
- Requires a 2-step process
  - Step 1: optimize schedules outside of CA without transfers to CA in order to determine “economic base” and not inappropriately impact LMPs and dispatch opportunity outside of CA
  - Step 2: optimize transfers to CA and compare with step 1 to determine incremental dispatch responsible

## Option 2 - Modify optimization, but maintain resource specific cost and attribution (2 of 2)

- Real-time dispatch is used to operate the grid
  - Must solve market optimization within 5-minutes
  - Solving the market twice to add GHG accounting functionality
  - Current computational power would require simplifying (less accurate) first pass to ensure RTD successfully completes
- “Leakage” can still occur when starting with optimized (or not perfectly) external schedules
  - Combined footprint re-dispatch to resolve congestion more economically
  - Combined footprint changes external unit commitment decision
  - Inconsistent external dispatch can still occur by forcing incremental, but it is minimized.

# Example 2a: Modify bids to create secondary dispatch in current EIM design and solver using current approach

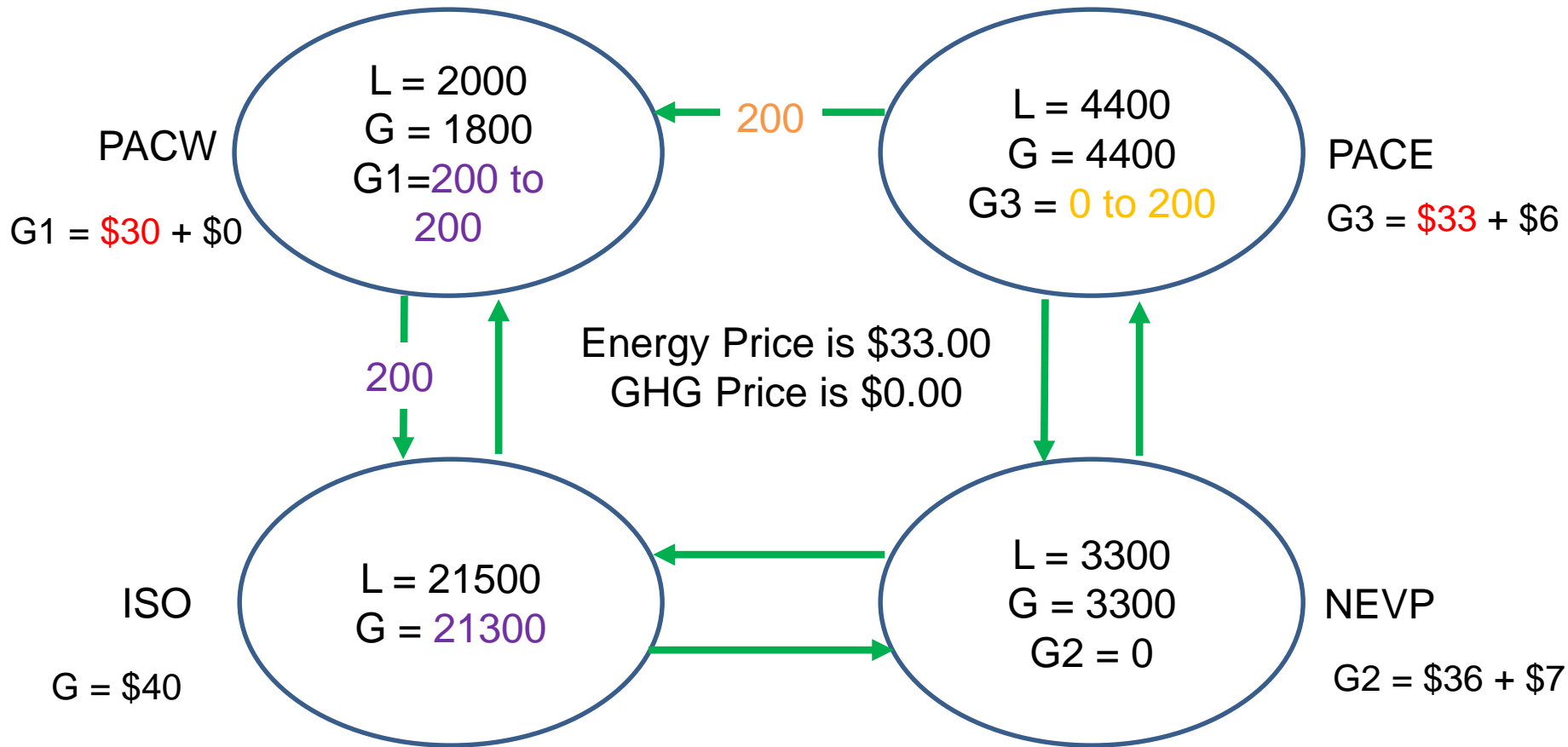

G1 attributed to support EIM transfer to ISO.  
 LMP in ISO is \$33. LMP outside the ISO is \$33.

# Example 2a: Perform the first pass to optimize base schedules

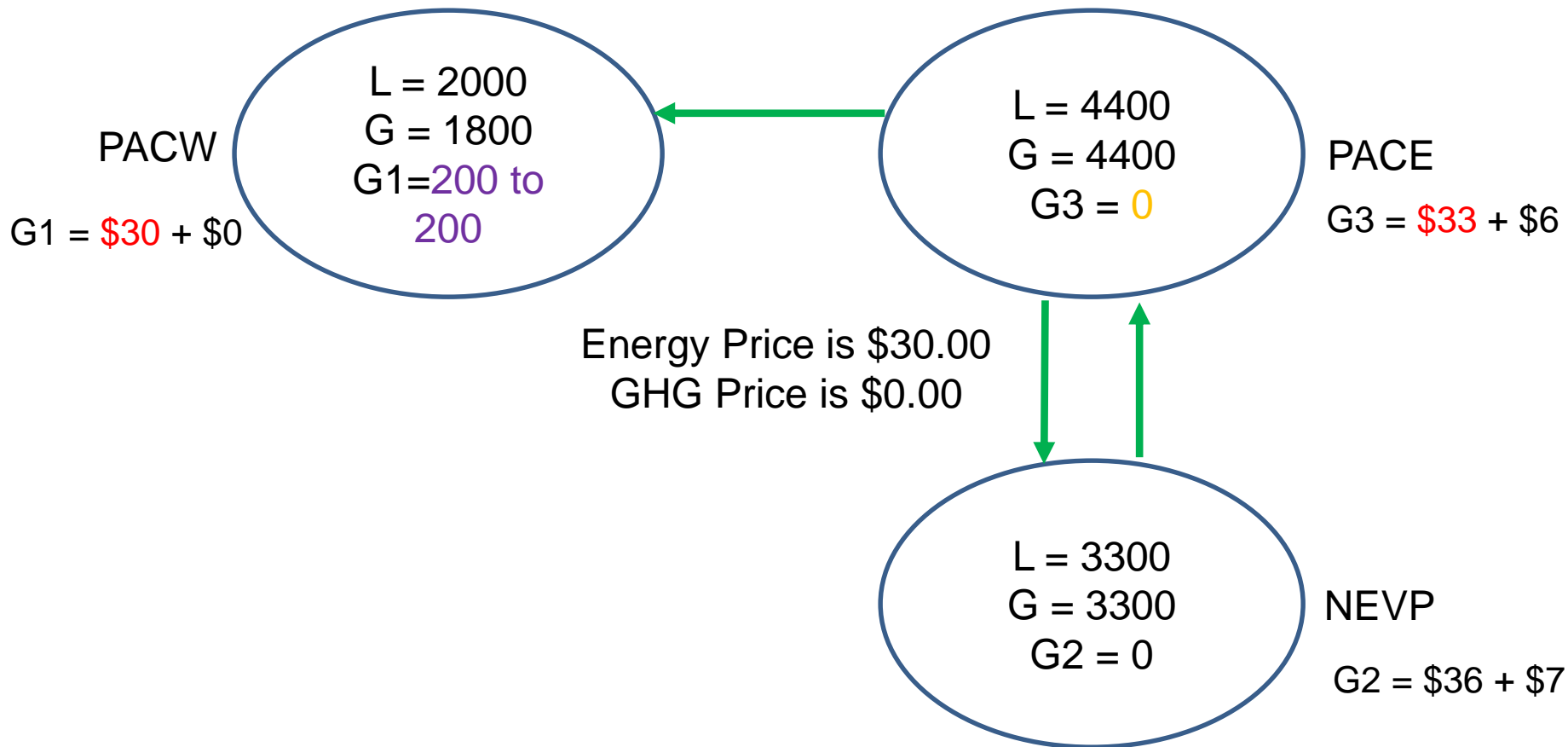

No change in dispatch because base schedules are optimal.  
LMP outside of ISO is \$30

# Example 2a: Perform second pass where only incremental dispatch can be attributed to support EIM transfer to ISO

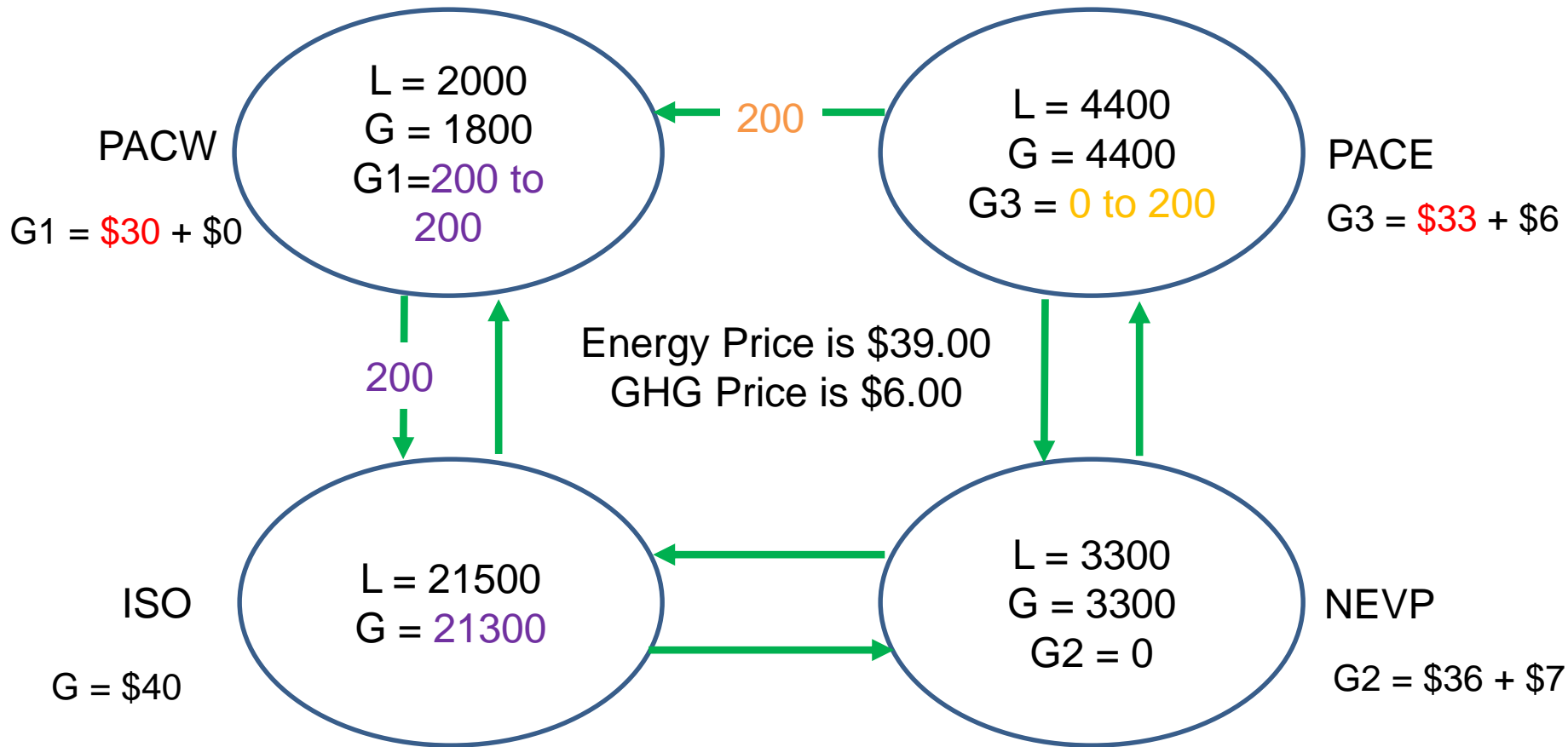

G3 is attributed as supporting 200MW transfer  
 LMP in ISO is \$39. LMP outside ISO is \$33.

## Example 2a: Summary

	Current Dispatch	Current Price	Option 2 Dispatch	Option 2 Price
G1 Energy	200	\$33	200	\$33 (\$39-\$6)
G1 GHG	200	\$0	0	\$6
G3 Energy	200	\$33	200	\$33 (\$39-\$6)
G3 GHG	0	\$0	200	\$6
G	-200	\$33	-200	\$39

# Example 2b: Use original bids where there was not a secondary dispatch and solve using current approach

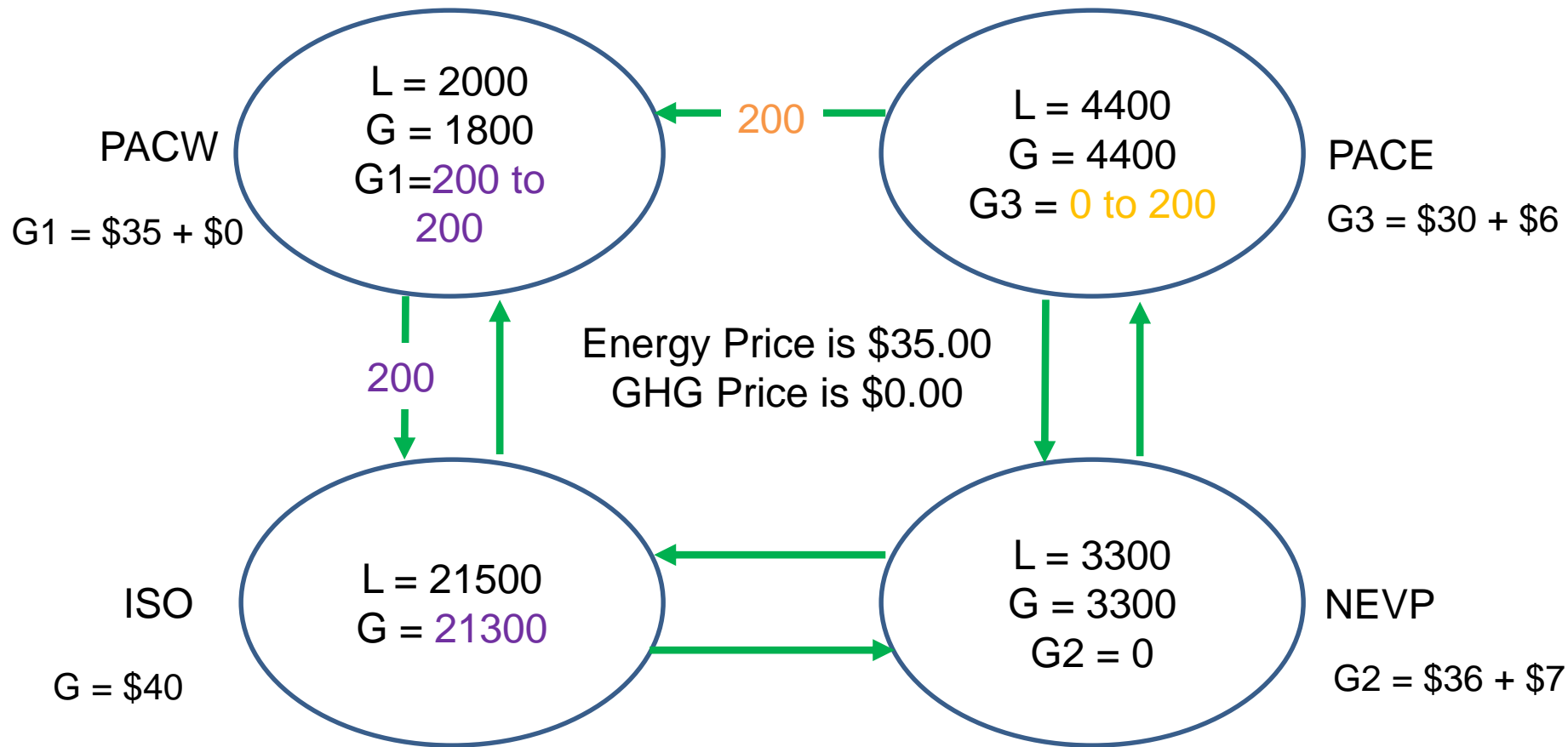

G1 attributed to support EIM transfer to ISO.  
 LMP in the ISO is \$35. LMP outside the ISO is \$35.

## Example 2b: Perform the first pass to optimize base schedules

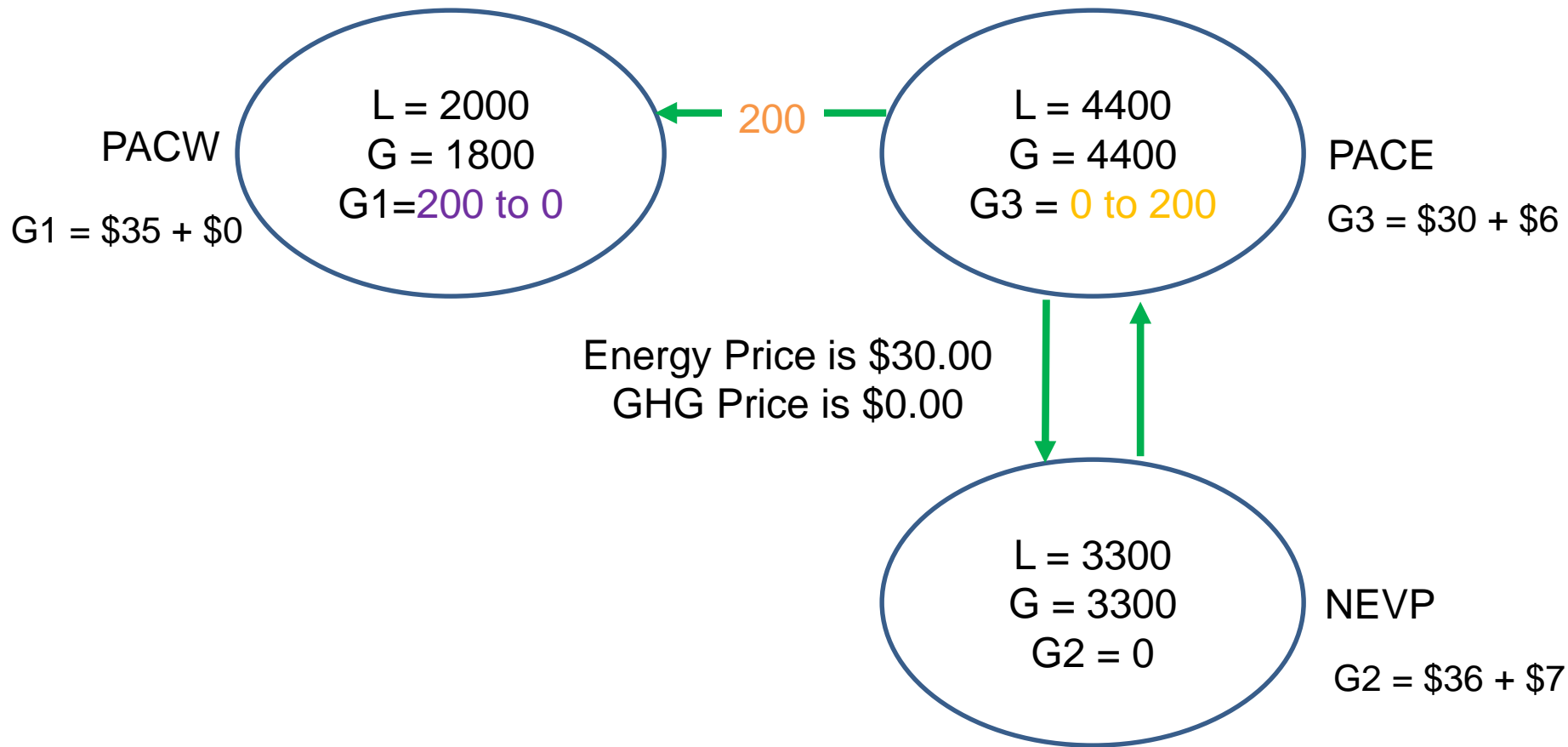

G3 is increased since it is lower cost than G1 which is reduced.  
LMP outside of ISO is \$30



# Example 2b: Perform second pass where only incremental dispatch can be attributed to support EIM transfer to ISO

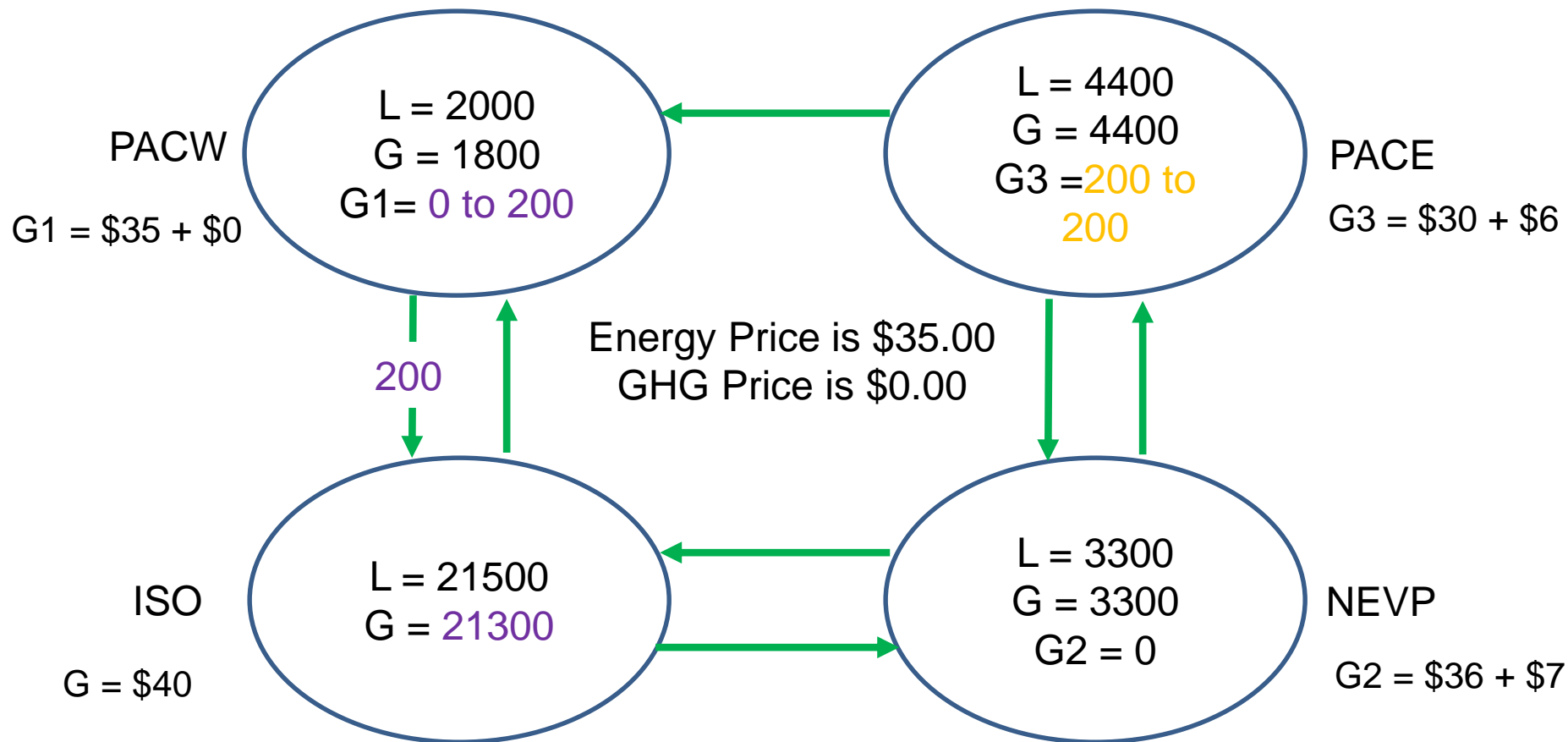

G1 is attributed as supporting 200MW transfer  
 LMP inside ISO is \$35. LMP outside of ISO is \$35.

## Example 2b: Summary

	Current Dispatch	Current Price	Option 2 Dispatch	Option 2 Price
G1 Energy	200	\$35	200	\$35 (\$35-\$0)
G1 GHG	200	\$0	200	\$0
G3 Energy	200	\$35	200	\$33 (\$35-\$0)
G3 GHG	0	\$0	0	\$0
G	-200	\$35	-200	\$35

## Option 3 - Modify optimization, residual emission rate for EIM transfers into ISO. No external resource attribution for residual. (1 of 2)

- Use existing market design with resource attribution
  - This determines the GHG price paid to attributed resources
- Add residual emission rate for energy flows in to CA zone
  - Same rate could be used in IFM, FMM, RTD, EIM
  - Residual rate could be zero
    - For example, gas resources historically set the GHG price
- If CA Load > CA Supply\*, include residual emission rate for each MW of transfer into ISO

\* CA supply is generation in CA and generation outside CA contracted with CA LSEs. All generation outside of CA has an energy bid and ghg cost.

## Option 3 - Modify optimization, residual emission rate for EIM transfers into ISO. No external resource attribution for residual. (2 of 2)

- Revenue collected is allocated to CA entity that which has the compliance obligation
  - This entity receives the money collected by the market to purchase instruments to surrender to CARB
- Price signal to external non-emitting resources is through forward contracting by CA LSEs.
  - Minimizes the application of the hurdle rate

# Example 3a: Modify bids to create secondary dispatch in current EIM design and solve using current design

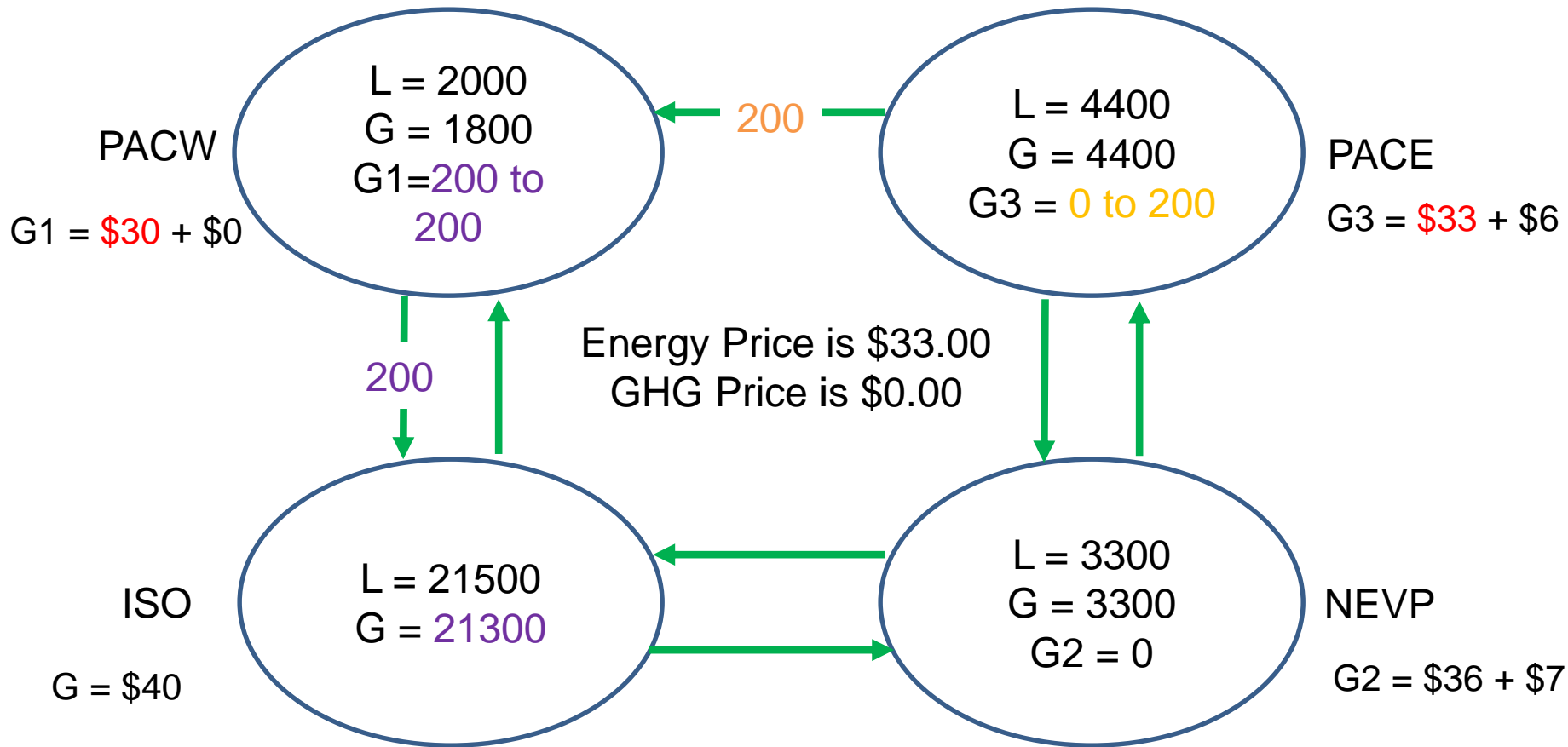

G1 attributed to support EIM transfer to ISO.  
LMP inside ISO is \$33. LMP outside ISO is \$33.

# Example 3a: Add a \$4 residual hurdle rate to cover historically observed missing emissions due to secondary dispatch

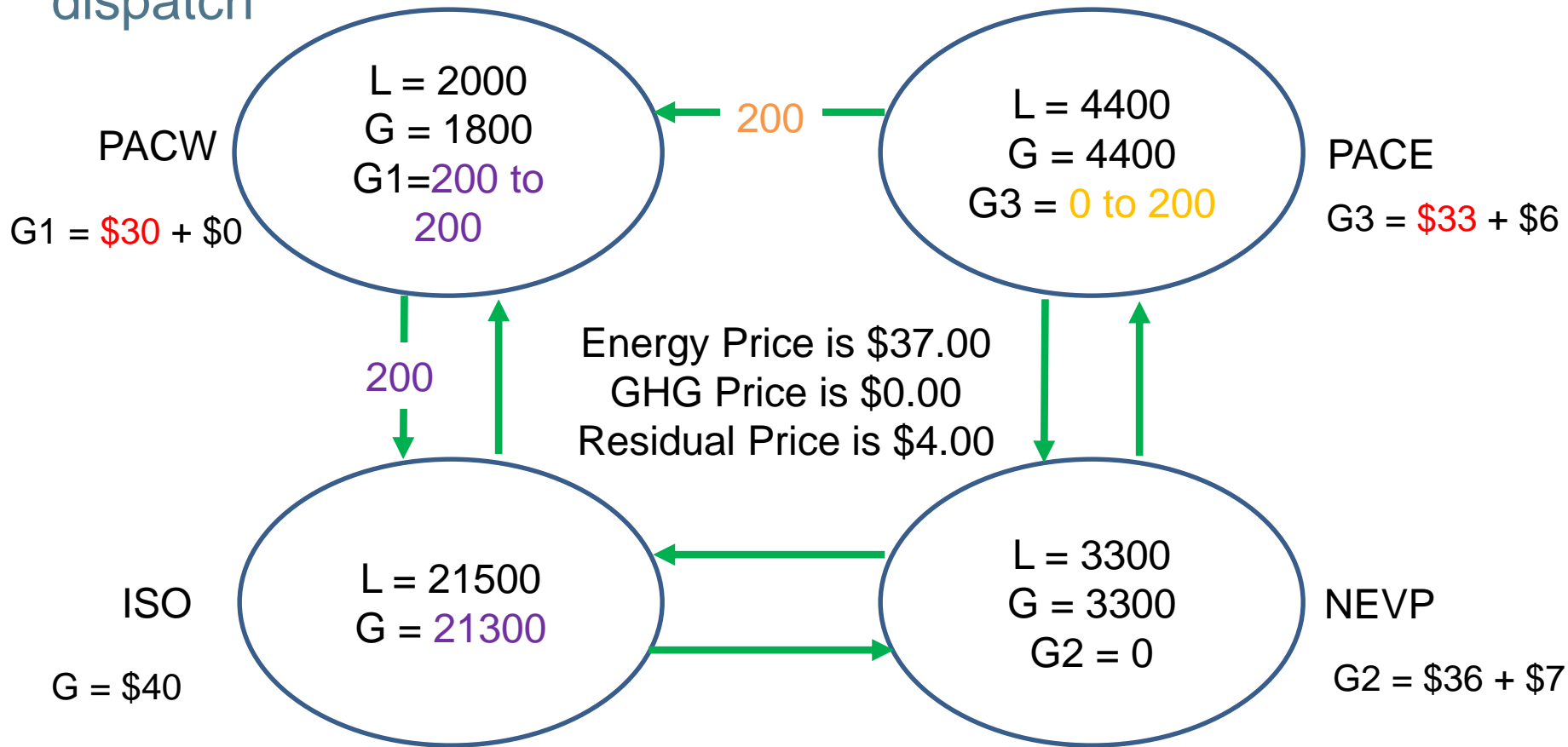

G1 attributed to support EIM transfer to ISO  
 LMP inside ISO is \$37. LMP outside ISO is \$33.

## Example 3a: Summary

	Current Dispatch	Current Price	Option 3 Dispatch	Option 3 Price
G1 Energy	200	\$33	200	\$33 (\$37-\$0-\$4)
G1 GHG	200	\$0	200	\$0
G3 Energy	200	\$33	200	\$33 (\$37-\$0-\$4)
G3 GHG	0	\$0	0	\$0
G	-200	\$33	-200	\$37
Residual GHG	200	N/A	200	\$4

# Example 3b: Use original bids where there was not a secondary dispatch and solve using current approach

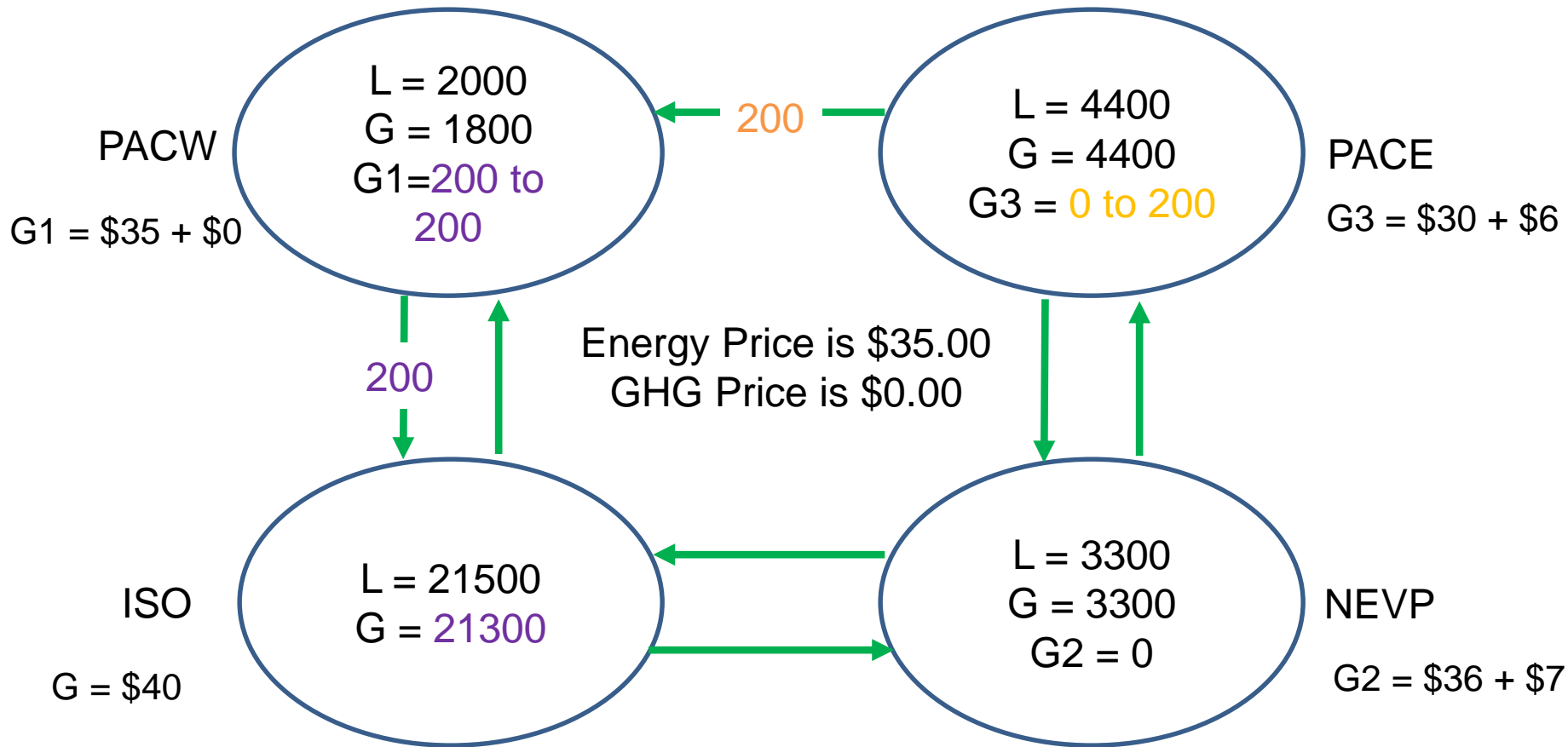

G1 attributed to support EIM transfer to ISO.  
 LMP inside ISO is \$35. LMP outside ISO is \$35.



# Example 3b: Add a \$4 residual hurdle rate to cover historically observed missing emissions due to secondary dispatch

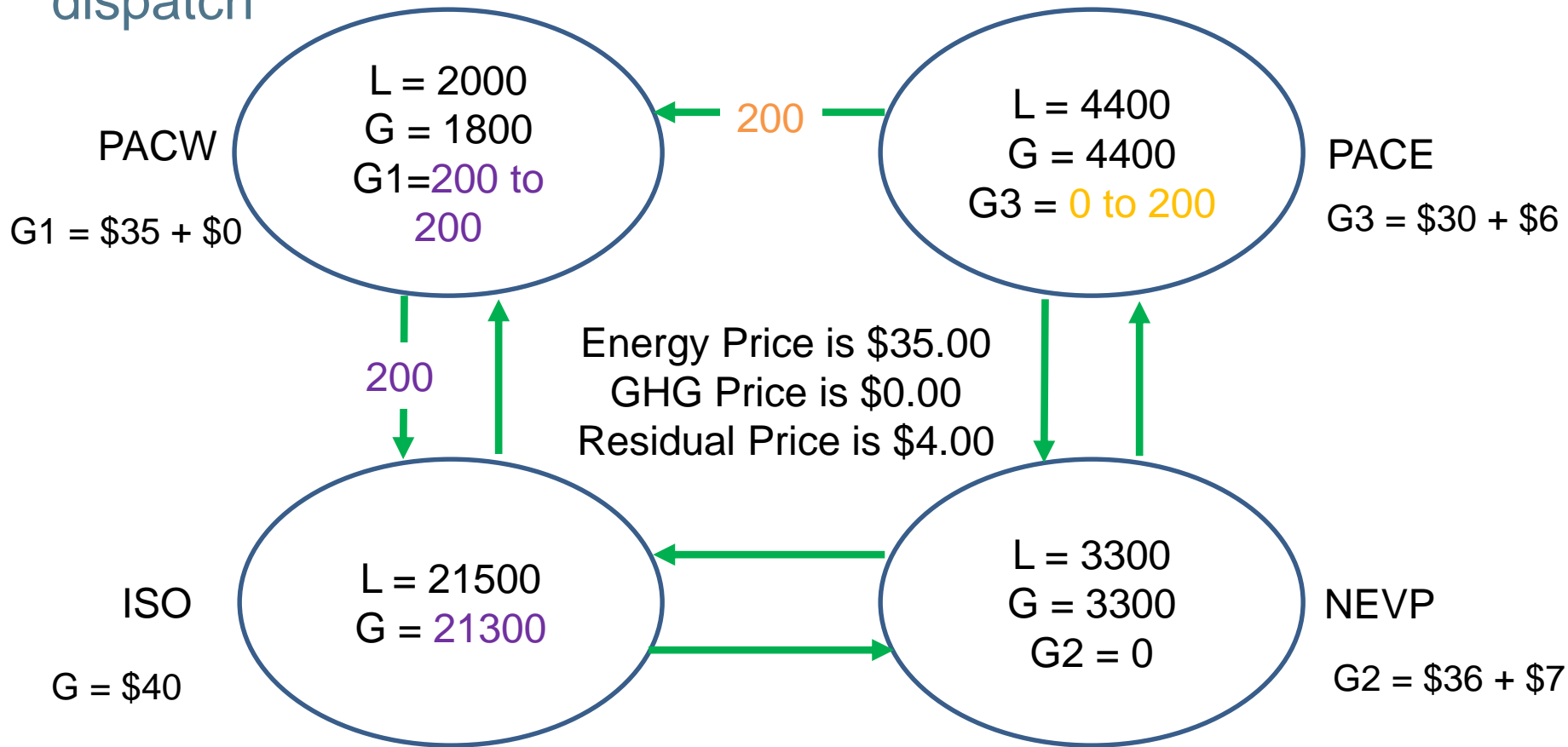

G1 attributed to support EIM transfer to ISO.  
 LMP inside ISO is \$35. LMP outside ISO is \$31.

## Example 3b: Summary

	Current Dispatch	Current Price	Option 3 Dispatch	Option 3 Price
G1 Energy	200	\$35	200	\$31 (\$35-\$0-\$4)
G1 GHG	200	\$0	200	\$0
G3 Energy	200	\$35	200	\$31 (\$35-\$0-\$4)
G3 GHG	0	\$0	0	\$0
G	-200	\$35	-200	\$35
Residual GHG	200	N/A	200	\$4

# Example 3c: Modify to show change in dispatch from residual emission and solve using current approach

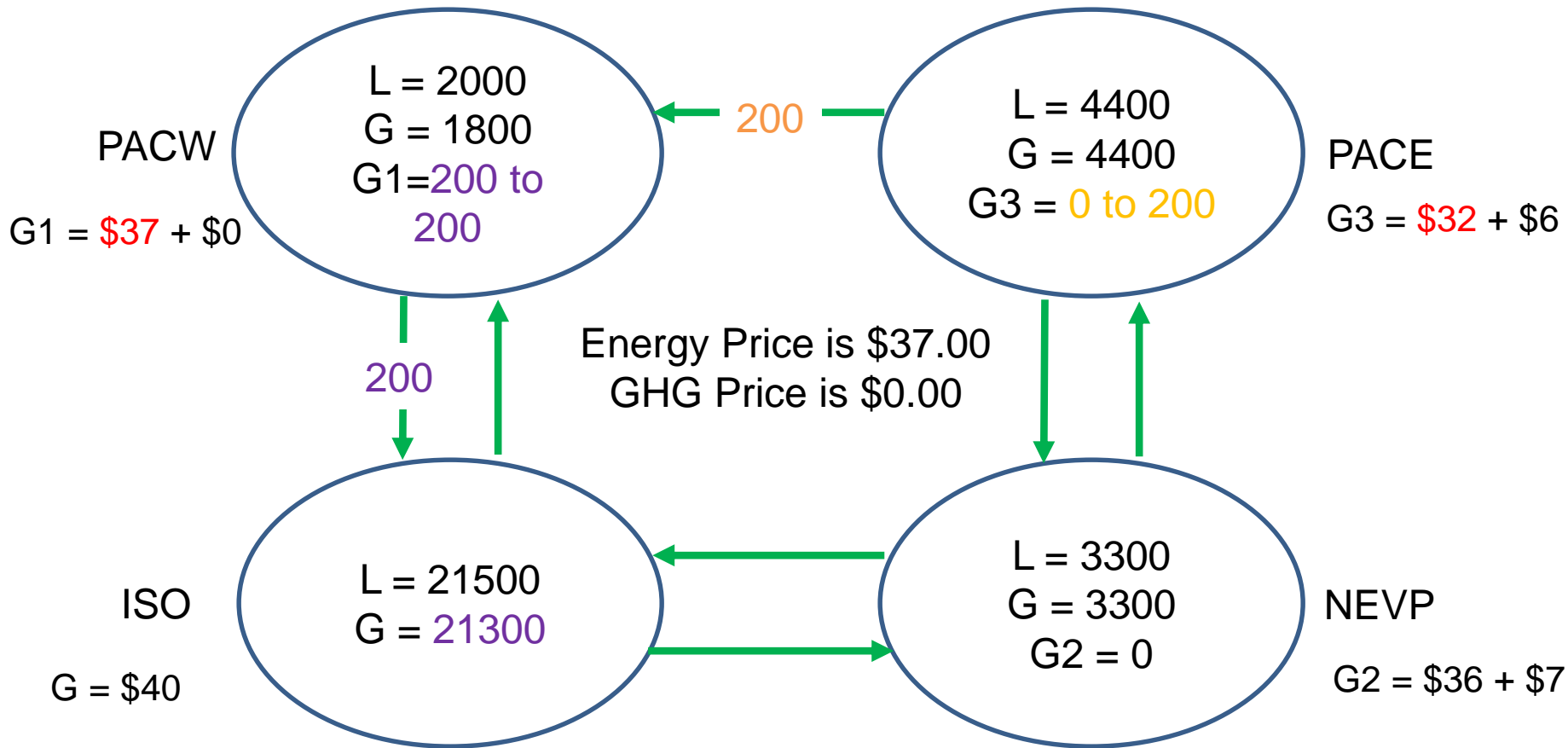

G1 attributed to support EIM transfer to ISO  
 LMP inside ISO is \$37. LMP outside ISO is \$33.

# Example 3c: Add a \$4 residual hurdle rate to cover historically observed missing emissions due to secondary dispatch

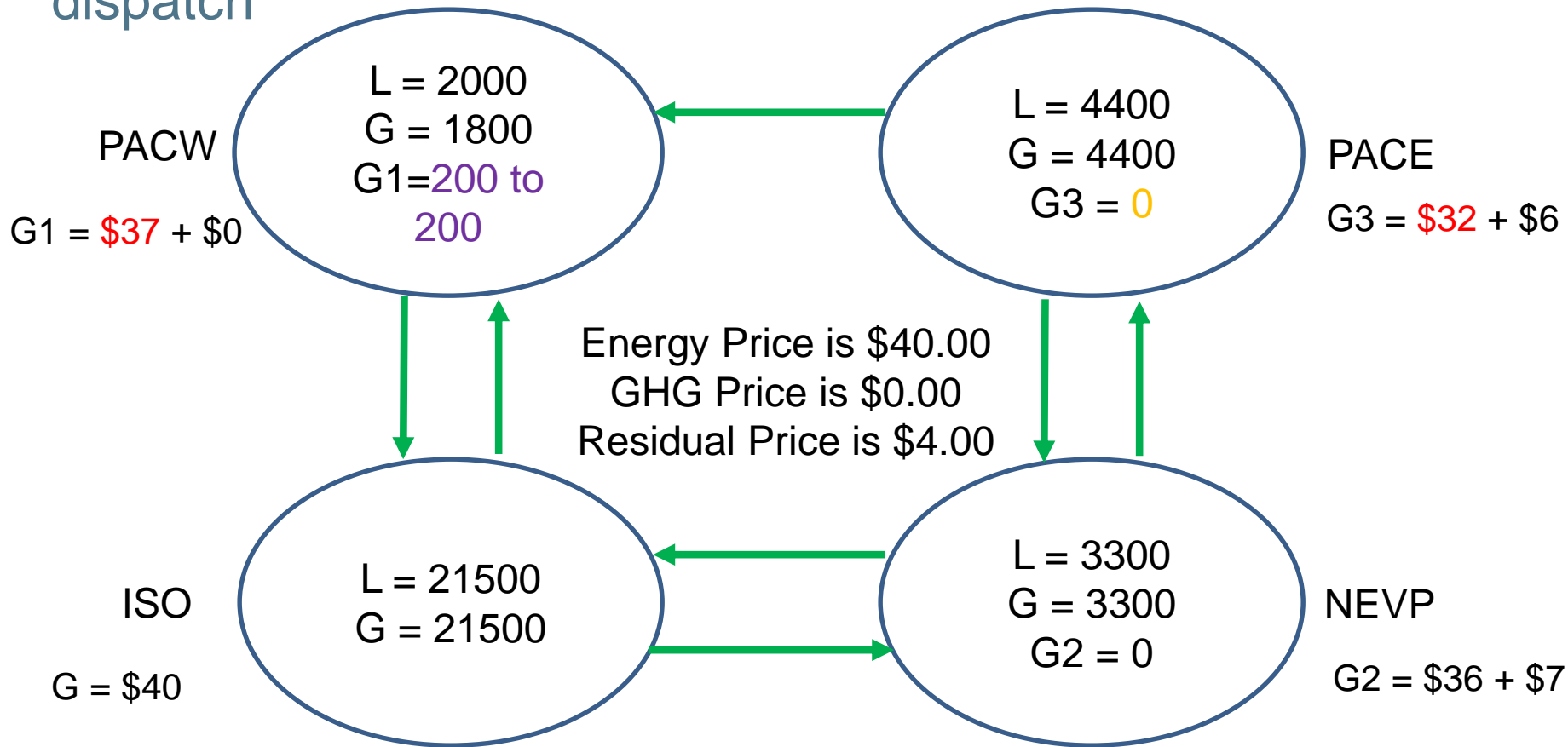

No transfers to the ISO because the energy + ghg + residual > \$40  
 LMP inside the ISO is \$40. LMP outside the ISO is \$36.

## Example 3c: Summary

	Current Dispatch	Current Price	Option 3 Dispatch	Option 3 Price
G1 Energy	200	\$37	200	\$36 (\$40-\$0-\$4)
G1 GHG	200	\$0	0	\$0
G3 Energy	200	\$37	200	\$36 (\$40-\$0-\$4)
G3 GHG	0	\$0	0	\$0
G	-200	\$37	0	\$40
Residual GHG	200	N/A	200	\$4

# Example 3d: Modify bids and solve using current approach

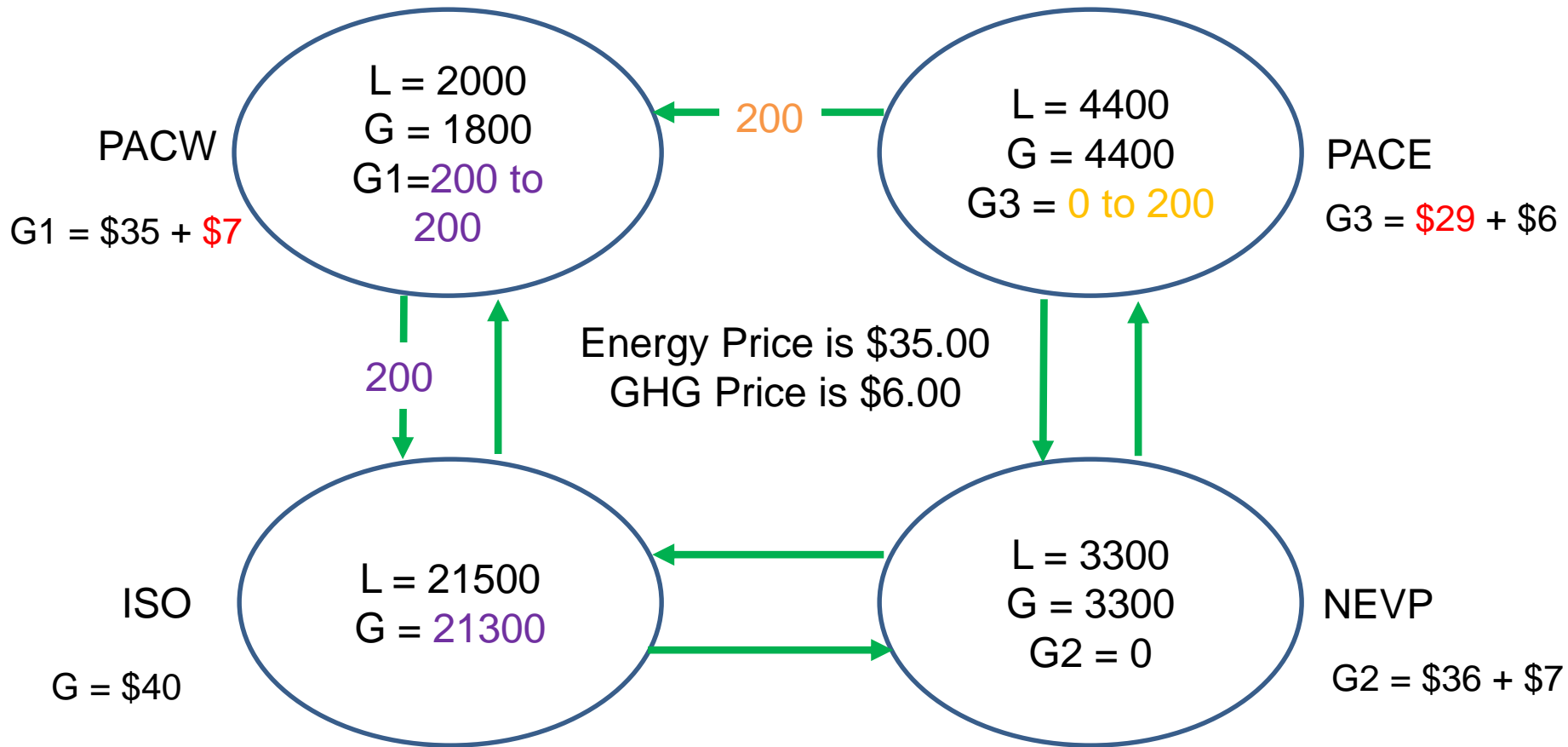

G1 attributed to support EIM transfer to ISO.  
LMP inside ISO is \$35. LMP outside ISO is \$29.

# Example 3d: Add a \$4 residual hurdle rate to cover historically observed missing emissions due to secondary dispatch

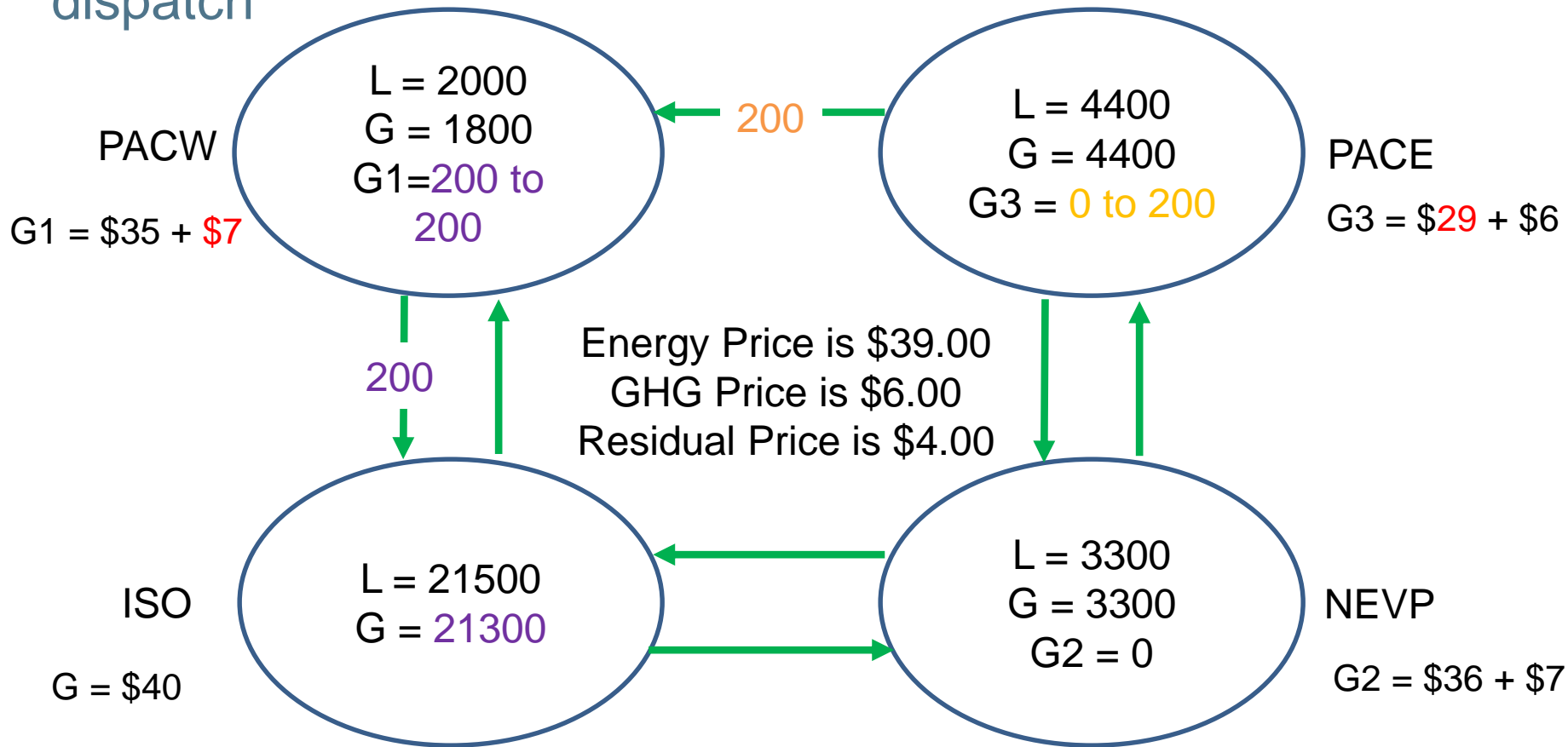

G1 attributed to support EIM transfer to ISO.  
 LMP inside ISO is \$39. LMP outside ISO is \$29.

## Example 3d: Summary

	Current Dispatch	Current Price	Option 3 Dispatch	Option 3 Price
G1 Energy	200	\$29	200	\$29 (\$39-\$6-\$4)
G1 GHG	0	\$6	0	\$6
G3 Energy	200	\$29	200	\$29 (\$39-\$6-\$4)
G3 GHG	200	\$6	200	\$6
G	-200	\$35	-200	\$39
Residual GHG	200	N/A	200	\$4



# How to determine the residual emission rate?

- Counterfactual over a period of time (seasonal rate)
- Is seasonal rate done by operating hour?
- Is seasonal rate daily and same for all hours?
- Prior interval dispatch of external resources

# Conclusion

- Option 1 – out
- Option 2 – not computationally feasible today
- Option 3 – can be implemented today
  - Maintaining the resource specific attribution allows us to eliminate the residual emission rate when option 2 if feasible

# Issues to be addressed in multi-state GHG market design

- GHG accounting associated with transfers within a multi-state balancing authority area
- Treatment of intertie scheduling points at the new multi-state balancing authority area boundary

Under a multi-state BAA, must be able to differentiate each state's load from other internal load, for example

- Generation and imports serving California\* load have California Cap-and-Trade obligation
- Generation and imports serving non-California load do not have a California Cap-and-Trade obligation
  - \*But may have its own state's CPP program
- Generation and load nodes are located in a single state
- Imports and exports may or may not be delivered to/from a specific state

## As balancing authority areas merge, intertie scheduling points change

- Schedules are not tagged within the multi-state balancing authority area
- Imports support load of entire balancing authority area
- Exports use generation of entire balancing authority area
- Need a new mechanism to determine which generation and imports support load and exports
  - May no longer use e-tags for all imports, the market will need attribution approach similar to EIM for imports

# Next Steps

NOTE: These dates are tentative until confirmed in a market notice.



Item	Date
Technical Workshop	October 13, 2016
Stakeholder Comments Due	October 27, 2016
Post Straw Proposal	November 10, 2016
Stakeholder Meeting	November 17, 2016
Stakeholder Comments Due	December 8, 2016
Post Draft Final Proposal	December 22, 2016
Stakeholder Conference Call	January 5, 2017
Stakeholder Comments Due	January 19, 2017

Please submit comments to [InitiativeComments@caiso.com](mailto:InitiativeComments@caiso.com)

# Appendix

# Import / export analysis requested by WPTF

Month	Year	RTD Imports (MWh)	RTD Exports (MWh)	Gross Import ETSR (MWh)	Gross Export ETSR (MWh)	EIM Transfers into ISO (MWh)	Non-ISO inside CA BAA Exports
January	2015	6,687,693	873,563	0	0	74,990	39,649
February	2015	6,057,175	807,915	0	0	48,913	27,938
March	2015	6,805,349	1,009,337	0	0	57,094	55,059
April	2015	5,848,324	973,769	0	0	51,978	43,954
May	2015	6,189,448	1,021,166	0	0	89,515	66,381
June	2015	5,846,401	1,235,251	0	0	119,676	111,687
July	2015	6,527,370	1,414,809	0	0	127,127	157,951
August	2015	6,944,149	1,308,078	0	0	85,923	162,416
September	2015	6,952,651	1,247,466	0	0	61,122	98,268
October	2015	6,311,486	959,712	0	0	43,237	49,540
November	2015	6,212,862	1,043,777	0	0	81,811	30,525
December	2015	6,547,073	1,253,180	173,894	80,623	151,751	44,693
January	2016	6,175,458	1,087,808	164,752	113,538	126,438	44,129
February	2016	5,617,170	786,442	182,573	99,652	161,706	43,822
March	2016	6,482,143	997,211	187,645	163,390	143,786	43,180
April	2016	6,179,133	975,852	166,048	162,537	131,756	47,833
May	2016	7,080,665	1,134,155	129,112	202,145	88,329	51,397
June	2016	6,943,267	1,400,800	134,292	188,350	96,471	71,516

RTD Imports (MWh) = RTD Gross Imports into ISO + Dynamic Schedules + EIM Transfers into ISO

RTD Exports (MWh) = RTD Gross Exports out of ISO + EIM Transfers out of ISO

Non-ISO inside CA BAA Exports = RTD exports that are inside California and are Non-ISO BAA (eg LADWP, SMUD, MID, TID)

Wheels are excluded from the data set



# How GHG costs are reflected in the market optimization and resources are attributed for serving CA load

- California Greenhouse Gas Regulation
- GHG Compliance in EIM:  
Problem and Solution
- Market Optimization Model Changes
- GHG Compliance Settlement in EIM
- Examples

# California Greenhouse Gas Regulation

- California Air Resources Board (CARB) implements three regulations:
  - Cap and Trade Regulation
    - Declining annual emission allowances
  - Mandatory Reporting Regulation
    - Annual reporting and verification of emissions
  - Cost of Implementation Administrative Fee Regulation
    - Collecting administrative fees for the cost of implementation

# California Cap-and-Trade program places compliance obligation on electrical supply serving California load

- Generators inside California have a Cap-and-Trade obligation
- Importers to California have a Cap-and-Trade obligation
- Compliance costs are included in the energy bids of generators and importers
- Compliance costs are recovered through energy payments by load and exporters

Applies to both the day-ahead and real-time market

# GHG Compliance Problematic for EIM

- Generating resources in ISO BAA and import resources on ISO interties include GHG compliance costs in their energy bids
  - Still applicable with EIM
- Not applicable to generating resources in EIM BAAs or import resources on EIM interties
  - Imbalance energy from EIM resources serves EIM load (no GHG regulation) or EIM transfer into CA (subject to GHG regulation)

# Energy imbalance market design recognizes only ISO is subject to the California Cap-and-Trade program

- Energy generated and consumed outside of ISO does not have a GHG compliance cost
- Energy generated outside of ISO supporting and EIM transfer serving ISO load has a GHG compliance cost
- Energy generated inside the ISO has a GHG compliance cost

# GHG Compliance Solution for EIM

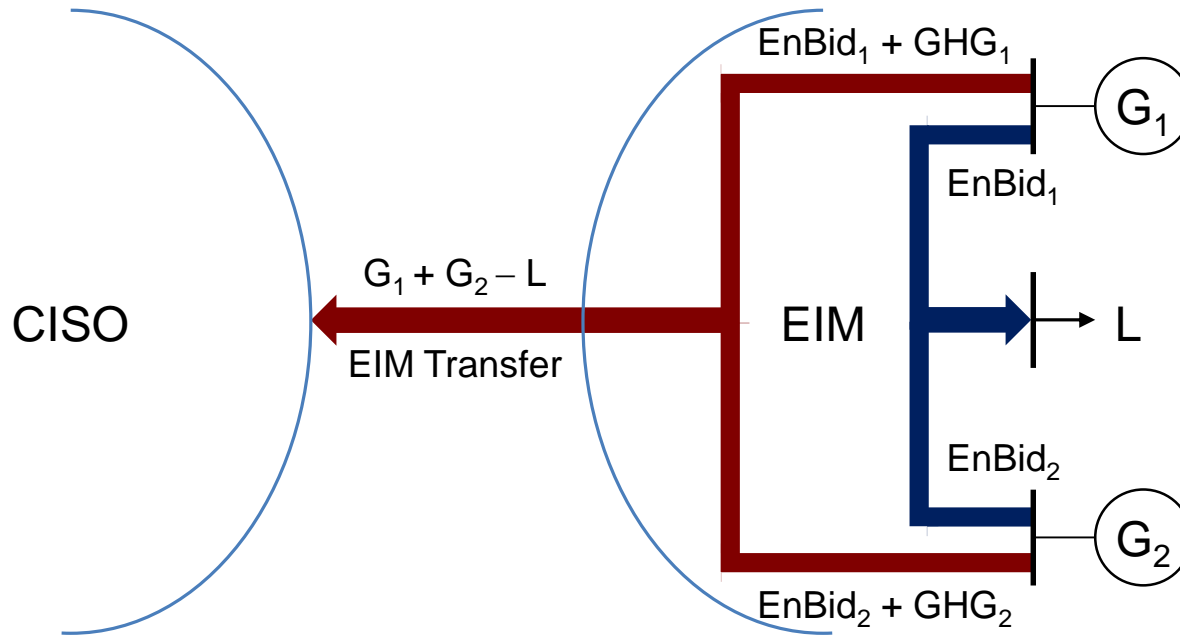

Punchline

# Market Optimization Model Changes for GHG Compliance in EIM

- Allow a GHG bid adder from EIM Participating Resources
  - Resource can opt out by bidding 0MW in a given hour
- Introduce a new decision variable for each EIM Participating Resource: EIM export allocation
- Add the GHG bid cost of the EIM export allocation to the objective function
- Cap the EIM export allocation by the dispatch
- Fully allocate net EIM Transfer export to EIM Participating Resources

# GHG Compliance Settlement in EIM

- Marginal GHG compliance cost is the shadow price of the EIM Transfer export allocation
  - Zero for EIM Transfer import
- It becomes the 4<sup>th</sup> LMP component for EIM BAAs
- GHG compliance revenue from net imbalance energy settlement in EIM BAAs
  - Paid to EIM Participating Resources for their EIM Transfer export allocation
- Market Operator is revenue neutral



# The business practice manual for energy imbalance market describes the GHG market design in detail

- BPM is available at <https://bpmcm.caiso.com/Pages/BPMDetails.aspx?BPM=Energy%20Imbalance%20Market>
- See sections 11.3.3.1 and 11.3.3.2

## Locational Marginal Price has the following components

- ISO LMP = SMEC – Congestion – Loss
- EIM BAA LMP = SMEC – Congestion – Loss – GHG
- SMEC is the same at all nodes
- Loss is a function of the SMEC
- In the following examples,

$\mu$  = Marginal Cost of Congestion

$\eta$  = Marginal Cost of GHG Compliance

# Discuss market optimization examples

One generator and a load are in the CAISO, and two generators and a load are in the EIM Entity BAA, as shown in the figure below.

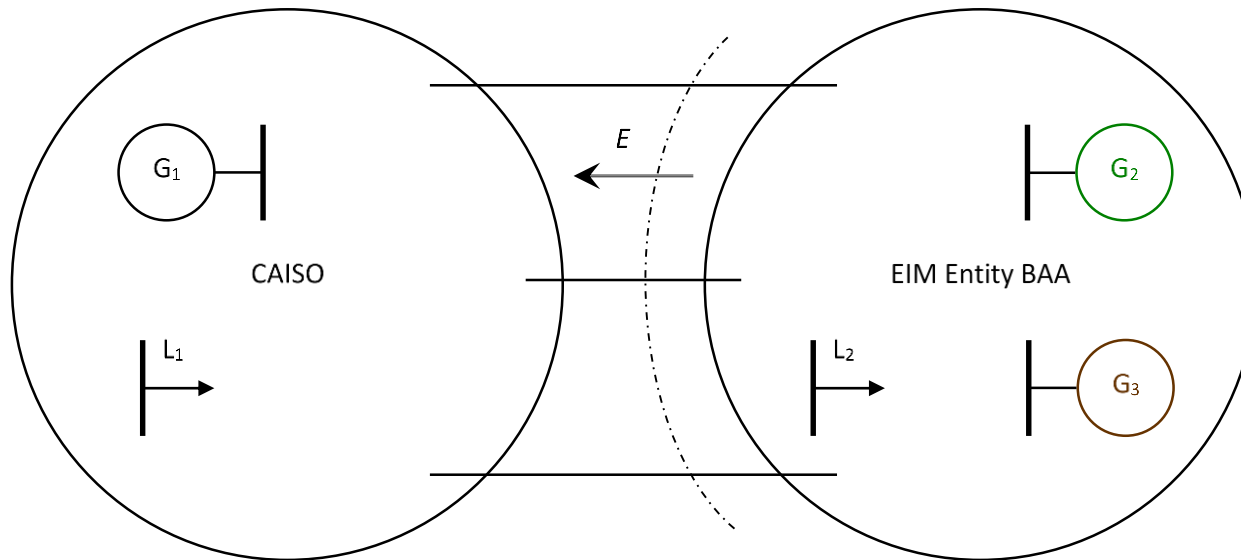

The power transfer ( $E$ ) between the BAAs is limited to 100MW

# Example 1 – Market Optimization

Punchline in title of slide

## Resource data

Load	Forecast (MW)
L <sub>1</sub>	200
L <sub>2</sub>	50

Generator	Minimum (MW)	Maximum (MW)	Energy Bid (\$/MWh)	GHG Compliance Bid Adder (\$/MWh)
G <sub>1</sub>	0	300	50	-
G <sub>2</sub>	0	200	35	0
G <sub>3</sub>	0	200	30	6

## Optimal dispatch

Resource	Dispatch (MW)	Export Allocation (MW)	LMP (\$/MWh)
G1	100	-	50
G2	100	100	30
G3	50	0	30
L1	200	-	50
L2	50	-	30

Example 1:  $\mu = -\$15/\text{MWh}$ ;  $\eta = -\$5/\text{MWh}$

# Example 1 – Settlement

Resource	Energy Cost	GHG Compliance Cost	Total Cost	Energy Payment	GHG Compliance Payment	Total Payment
G <sub>1</sub>	\$5,000	-	\$5,000	\$5,000	-	\$5,000
G <sub>2</sub>	\$3,500	\$0	\$3,500	\$3,000	\$500	\$3,500
G <sub>3</sub>	\$1,500	\$0	\$1,500	\$1,500	\$0	\$1,500
L <sub>1</sub>				-\$10,000		
L <sub>2</sub>				-\$1,500		
Congestion Revenue				\$1,500		
GHG Compliance Revenue				\$500		

# Example 2 – Market Optimization

## Resource data

Load	Forecast (MW)
L <sub>1</sub>	200
L <sub>2</sub>	50

Generator	Minimum (MW)	Maximum (MW)	Energy Bid (\$/MWh)	GHG Compliance Bid Adder (\$/MWh)
G <sub>1</sub>	0	300	50	-
G <sub>2</sub>	0	200	35	0
G <sub>3</sub>	0	200	28	6

G3 reduces energy bid to \$28

## Optimal dispatch

Resource	Dispatch (MW)	Export Allocation (MW)	LMP (\$/MWh)
G <sub>1</sub>	100	-	50
G <sub>2</sub>	0	0	28
G <sub>3</sub>	150	100	28
L <sub>1</sub>	200	-	50
L <sub>2</sub>	50	-	28

Example 2:  $\mu = -\$16/\text{MWh}$ ;  $\eta = -\$6/\text{MWh}$

# Example 2 - Settlement

Resource	Energy Cost	GHG Compliance Cost	Total Cost	Energy Payment	GHG Compliance Payment	Total Payment
G <sub>1</sub>	\$5,000	-	\$5,000	\$5,000	-	\$5,000
G <sub>2</sub>	\$0	\$0	\$0	\$0	\$0	\$0
G <sub>3</sub>	\$4,200	\$600	\$4,800	\$4,200	\$600	\$4,800
L <sub>1</sub>				-\$10,000		
L <sub>2</sub>				-\$1,400		
Congestion Revenue				\$1,600		
GHG Compliance Revenue				\$600		

# Example 3 – Market Optimization

## Resource data

Load	Forecast (MW)
L <sub>1</sub>	200
L <sub>2</sub>	50

Generator	Minimum (MW)	Maximum (MW)	Energy Bid (\$/MWh)	GHG Compliance Bid Adder (\$/MWh)
G <sub>1</sub>	0	300	50	-
G <sub>2</sub>	0	200	35	0
G <sub>3</sub>	0	75	28	6

Maximum capacity of G3 is reduced to 75MW

## Optimal dispatch

Resource	Dispatch (MW)	Export Allocation (MW)	LMP (\$/MWh)
G <sub>1</sub>	100	-	50
G <sub>2</sub>	75	75	29
G <sub>3</sub>	75	25	29
L1	200	-	50
L2	50	-	29

Example 3:  $\mu = -\$15/\text{MWh}$ ;  $\eta = -\$6/\text{MWh}$



# Example 3 - Settlement

Resource	Energy Cost	GHG Compliance Cost	Total Cost	Energy Payment	GHG Compliance Payment	Total Payment
G <sub>1</sub>	\$5,000	-	\$5,000	\$5,000	-	\$5,000
G <sub>2</sub>	\$2,625	\$0	\$2,625	\$2,175	\$450	\$2,625
G <sub>3</sub>	\$2,100	\$150	\$2,250	\$2,175	\$150	\$2,325
L <sub>1</sub>				-\$10,000		
L <sub>2</sub>				-\$1,450		
Congestion Revenue				\$1,500		
GHG Compliance Revenue				\$600		

# Example 4 – Market Optimization

## Resource data

Load	Forecast (MW)
L <sub>1</sub>	200
L <sub>2</sub>	50

Generator	Minimum (MW)	Maximum (MW)	Energy Bid (\$/MWh)	GHG Compliance Bid Adder (\$/MWh)
G <sub>1</sub>	0	300	50	-
G <sub>2</sub>	0	200	35	0
G <sub>3</sub>	0	75	28	6
G <sub>4</sub>	0	100	30	3

New external resource G4

## Optimal dispatch

Generator	Dispatch (MW)	Export Allocation (MW)	LMP (\$/MWh)
G <sub>1</sub>	0	-	35
G <sub>2</sub>	75	75	29
G <sub>3</sub>	75	25	29
G <sub>4</sub>	100	100	29

Example 4:  $\mu = \$0/\text{MWh}$ ;  $\eta = -\$6/\text{MWh}$

# Example 4 - Settlement

Resource	Energy Cost	GHG Compliance Cost	Total Cost	Energy Payment	GHG Compliance Payment	Total Payment
G <sub>1</sub>	\$0		\$0	\$0		\$0
G <sub>2</sub>	\$2,625	\$0	\$2,625	\$2,175	\$450	\$2,625
G <sub>3</sub>	\$2,100	\$150	\$2,250	\$2,175	\$150	\$2,325
G <sub>4</sub>	\$3,000	\$300	\$3,300	\$2,900	\$600	\$3,500
L <sub>1</sub>				-\$7,000		
L <sub>2</sub>				-\$1,450		
Congestion Revenue				\$0		
GHG Compliance Revenue				\$1,200		