

APPENDIX H: Pacific Northwest – California Transfer Increase Informational Special Study

Intentionally left blank

Table of Contents

1	Introduction	4
2	Objective	5
3	Study Assumptions and Criteria.....	6
	3.1 LADWP Studies on PDCI Rating Upgrade	6
4	Increase the Capacity of AC and DC Interties.....	8
	4.2 Near-term Assessment (Year 2023).....	9
	4.2.1 Near-term Assessment – 5,100 MW North to South Flow on COI	10
	4.2.2 Near-term Assessment – South to North Flow on PDCI and COI	16
	4.3 Long-term Assessment (Year 2028).....	19
	4.3.1 PNW Hydro Model in Production Cost Model (PCM)	19
	4.3.2 Analysis of Long-term Assessment Results	24
	4.3.3 Summary of Longer-term Assessment Results	26
5	Increase Dynamic Transfer Capability (DTC).....	27
	5.4 Excessive voltage fluctuations and reactive switching.....	27
	5.5 RAS Arming	27
	5.6 Voltage Stability	27
	5.7 Potential Solutions To Increase DTC.....	27
6	Implementing sub-hourly scheduling on PDCI	29
7	Assigning Resource Adequacy (RA) Value to firm zero-carbon imports.....	30
	7.1 ISO’s RA procurement process	30
	7.2 Historical MIC allocation on the Malin 500 Branch Group.....	30
	7.3 Historical RA showings on the Malin 500 Branch Group.....	31
	7.4 Historical MIC allocation on NOB Branch Group (PDCI).....	32
	7.5 Historical RA showings on NOB Branch Group (PDCI)	32
	7.6 COI and PDCI Flows in Real Time	33
	7.7 Potential barriers for higher RA showings.....	34
	7.8 Summary of RA Analysis.....	34
8	Summary and Conclusions.....	36
	8.1 Next Steps	37

Attachments

Attachment 1 BPA DTC Roadmap

1 Introduction

On February 15, 2018, the ISO received a request from Robert B. Weisenmiller, Chair of the CEC and Michael Picker, President of the CPUC¹, that the ISO undertake a transmission sensitivity study within the 2018-2019 transmission planning process focused on increasing capabilities for transfers of carbon-free electricity between the Pacific Northwest and California. Expanded transmission capability, and increasing the transfer of low-carbon supplies to and from the Northwest in particular, was seen to be one of the multiple puzzle pieces that the agencies must examine to build a cumulative phase out strategy of Aliso Canyon usage and address potential impacts on the gas-fired generation fleet. The request provided the following synopsis for the sensitivity study:

- Increasing rated capacity of AC Intertie and Pacific DC Intertie. Explore the costs and benefits of potential increases to AC and DC intertie capacity with the Pacific Northwest (PNW), considering a range of options as well as assessing downstream impacts to transmission within California.
- Increasing dynamic transfer capability limits beyond 400 MW. Conduct engineering analyses to determine an upper limit on dynamic transfer capability from the BPA system. Reflect BPA Reliability Action Scheme (RAS) automation efforts and the relationships to voltage variability and stability concerns within both the BPA system and the broader Northwest grid.
- Automating manual controls on key BPA infrastructure. Assume that within a five-year horizon BPA (at Cellilo) and operators at Sylmar deploy necessary upgrades to the automatic generation control and Energy Management Systems (EMS) operating at the converter stations to facilitate intra-hour scheduling on the Pacific DC Intertie and perform sensitivity analyses to assess the impacts to Northwest hydro energy transfer capability from a reliability and ramping perspective to support the goal of closing Aliso Canyon.
- Assigning some RA value to firm zero-carbon imports or transfers. Develop a bounding case that assumes maximal utilization of existing infrastructure investments supporting Energy Imbalance Market operations of participating entities in the Northwest, as well as the integration of synchro-phasor data into control room operations. This case will inform further study and explore the maximum annual expected Northwest hydro import capability of the California ISO grid to estimate an upper bound on avoided GHG emissions assuming that RA/RPS counting criteria are not limiting.

These studies focused on evaluating key options to increase transfer ratings of the AC and DC interties with the Pacific Northwest, and assessing what role these systems can play in displacing generation whose reliability is tied to Aliso Canyon.

The expectation was that the insights gained from this sensitivity study can be used to inform a broader assessment of Aliso Canyon Phase-Out options, consistent with the direction the state

¹ <http://www.caiso.com/Documents/CPUCandCECLettertoISO-Feb152018.pdf>

agencies have received to develop plans that would allow for the shutdown of the Aliso Canyon Natural Gas Storage Facility.

The ISO has collaboratively worked with the California Energy Commission (CEC), the California Public Utilities Commission (CPUC), Bonneville Power Administration (BPA), Los Angeles Department of Water and Power (LADWP), and Southern California Edison (SCE) to develop this study scope. In addition, a high-level review of study objectives and of the scope was provided to other owners and operators of the path to ensure alignment on all aspects of this informational special study and will do as required throughout study. These owners and operators included PG&E, TANC, WAPA, PacifiCorp, PGE, the City of Glendale, the City of Burbank, the City of Pasadena, and BANC.

The intent of this document is to articulate clearly the objective of the study, the assumptions and study methodology, roles and responsibility of different entities in the study and deliverables.

2 Objective

The objective of this study was to explore the following four aspects of how to increase the power transfer capability between Pacific Northwest and California taking into account planning, operation, and market considerations.

- Increase the Capacity of AC and DC Interties
- Increase Dynamic Transfer Capability
- Control Automation (Sub-hourly scheduling on PDCI)
- Assigning RA Value to Imports

For each of the above study items, the existing limitations would be reviewed and documented followed by identifying incremental system enhancements that would be required to address the limitation and increase the transfer capability.

The study would identify possible increase in transfer capability in near term and long term. The near term study would focus on how to increase the transfer capability by utilizing the existing infrastructure under favorable conditions and without significant system reinforcements. The longer-term study would evaluate availability of hydro resources in PNW in the long term and how much additional transfer capability would be required to fully utilize the hydro resource.

This sensitivity study was done mainly for informational purposes. Therefore, it was not expected that any transmission project to be approved as part of this study. However, minor upgrades could be considered for approval, especially if they are beneficial in baseline studies, by being referred to the ISO's economic study process.

3 Study Assumptions and Criteria

Details of the study assumptions, methodology, and criteria are provided in the Study Plan². A key parameter in these studies is the categorization of the contingency of two adjacent circuits not on the same tower, which varies between different standards:

- The WECC Regional Criteria used to treat adjacent 500 kV lines (250 feet separation or less) as a P7 contingency
- The WECC Path Rating process currently treats the contingency as a P7
- The NERC TPL-001-4 standard considers the N-2 of adjacent circuits not on same tower as an Extreme Event (regardless of separation), and the N-1-1 is considered a P6 contingency
- CAISO operations treats the N-2 contingency on COI lines in the same right-of-way but on separate towers (that have less than 250 feet separation) as a conditionally credible contingency. Operations treats these contingencies to be credible, and set operating limits accordingly only, when there is a risk such as fire or severe weather conditions in the area of the lines.

WECC is currently reviewing its Path Rating process with regards to the contingency loss of adjacent circuit.³ In this study, the rating of the transmission paths were calculated for both the P6 and P7 treatment of the N-2 contingencies.

3.1 LADWP Studies on PDCI Rating Upgrade

As discussed in the Study Plan, the WECC path rating of the PDCI is 3220 MW in the north to south and 3100 MW in the south to north direction. LADWP limits the flow in real time operation to 3210 MW in the north to south and 1,000 MW in the south to north direction. LADWP is commencing a third party consultant study to conduct an engineering and planning study to identify the system upgrades, modifications, outage constraints required to increase the PDCI transfer capability from 3220 MW to 3800 MW. Intermediate upgrades shall also be considered where appropriate, to improve transfer capacity beyond 3220 MW while minimizing the capital investment and outage times. The impact of these upgrades on the feasibility of reusing the existing towers and conductors will also be evaluated.

The study will include the cost associated with all upgrades/modifications identified in the analysis, the outage time and constraints required to perform the upgrade work, and the intermediate

² <http://www.caiso.com/Documents/FinalStudyScopeforTransfersbetweenPacificNorthwestandCalifornia.pdf>

³ https://www.wecc.biz/_layouts/15/WopiFrame.aspx?sourcedoc=/Administrative/Path%20Rating%20Process%20Update.pdf&action=default&DefaultItemOpen=1

https://www.wecc.biz/_layouts/15/WopiFrame.aspx?sourcedoc=/Administrative/Summary%20of%20Common%20Corridor.pdf&action=default&DefaultItemOpen=1

https://www.wecc.biz/_layouts/15/WopiFrame.aspx?sourcedoc=/Administrative/PRPTF%20Charter_Aproved.docx&action=default&DefaultItemOpen=1

system impacts during project implementation and construction stages. Below is more detailed information that will be covered as part of the study.

Engineering and Planning Study

Performance of a system impact study (SIS) which includes:

- Study plan and list of assumptions, criteria and contingencies that will be used to comply with the NERC Reliability Standards.
- Steady state load flow analysis, short circuit analysis, and dynamic studies for system stability considerations needed to identify impacts on LADWP AC system at Sylmar AC switchyard and beyond as a result of the increase of HVDC capacity.
- The scenarios covered in study include but are not limited to voltage upgrade, current upgrade or a combination of both among all viable options.
- Analysis of inadvertent flows in the LADWP system and mitigation measures

Sylmar Converter Station and PDCI Analysis

The assessment shall include an engineering analysis to identify upgrades needed to reach reliable operations at 3800 MW:

- Upgrades required at Sylmar Converter Station (Southern terminus of the PDCI) including but not limited to:
 - Converter Valves
 - Converter Transformers
 - Controls and protection system
 - AC & DC filters
 - Electrode system
 - Cooling
 - Telecommunication
 - Civil and seismic upgrades
 - All other necessary and associated components
- An analysis of the 581 mile HVDC transmission line between the Nevada-Oregon Border (NOB) and Sylmar Converter Station identifying all upgrades required for operation at a higher voltage or current to achieve an increased transfer capability, up to a maximum of 3800 MW. The analysis shall include, but not limited to, a review of the following:
 - Insulation
 - Clearances and line sag

- Conductor surface gradient and the resulting audible and radio noise
- Electric field strength at ground level
- Thermal rating of conductors
- Lidar survey of bipole circuit and electrode
- Evaluation of reusing existing towers and conductors
- Any other limiting factors that would necessitate an infrastructure upgrade

LADWP is conducting these studies with full participation and cooperation of PDCI Southern participants including SCE and the Cities of Glendale, Burbank, and Pasadena. The studies are expected to be completed by the end of Q3, 2019.

Since the LADWP studies were not complete when this informational was performed, the current WECC and operational ratings of PDCI were used in this informational studies.

4 Increase the Capacity of AC and DC Interties

The Pacific Northwest (PNW) system covers the four US states of Washington, Oregon, Idaho and Montana. The system has 35,000 MW of installed hydro generation capacity with varying levels of energy and flexibility available in different seasons. The characteristics of load and generation resources in PNW and California provide an opportunity to exchange power between the two systems in a way that maximizes the utilization of the generation and transmission assets and minimize the total GHG emissions by electricity generation. There are two main interconnections between PNW and California power systems; California – Oregon Intertie (COI) and Pacific DC Intertie (PDCI). Based on the WECC path rating catalogue, the total transfer capacity of these paths are currently 8,020 MW in the north to south direction and 6,775 MW in the south to north direction. Figure 3.1-1 shows the schematic diagram of these WECC path and major 500 kV lines in the area. Benefits of increasing the capacity of AC and DC interties to increase the exchange of carbon-free electricity between PNW and California was explored in this study. This study was done for two time horizons; near term (year 2023) and long term (year 2028).

Figure 3.1-1: Schematic Diagram of AC and DC Interties between PNW and California

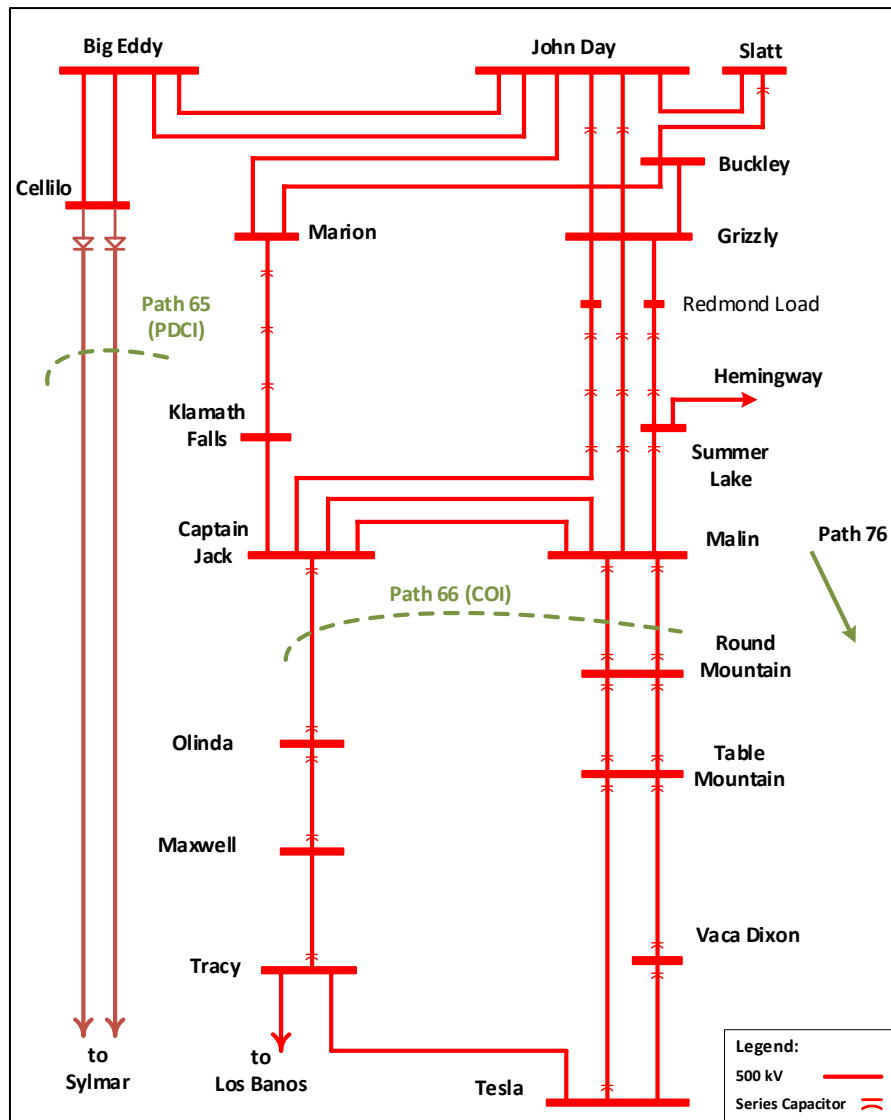

4.2 Near-term Assessment (Year 2023)

The focus of the near-term analysis was to assess the potential to maximize the utilization of the existing transmission system in both north to south (N-S) and south to north (S-N) flow directions and identify minor upgrades that may be required to increase the capacity. Likely conditions for high levels of power exchange between PNW and California were studied under two scenarios:

Energy Transfer

The assumption in this scenario is that sustained surplus energy is available in one system while demand exists in the other system. An example of a north to south energy transfer scenario could be early evenings in summer in which high temperatures and a lack of solar generation create high demand in California that could be served by surplus hydro generation in the northwest. A potential scenario for the energy transfer in the south to north direction is the late afternoon in the

fall in which there is surplus solar generation in California due to mild temperature that could be transferred to serve load in the northwest.

Resource Shaping

Maximum solar curtailment in California occurs in the middle of the day in early spring (March and April). The reason for solar curtailment is the significant amounts of solar generation while the load is relatively low (around 60% of the peak load). Another characteristic of California load in early spring is the high ramp rate in the late afternoon as solar generation, which is a significant portion of the supply at the time, quickly drops to almost zero in the space of a few hours. The basis for resource shaping scenario in the spring is to export the surplus generation in California to the PNW in the middle of the day (S-N flow) and import energy in late afternoon and early evening hours to help with the steep ramp (N-S flow). The assumption in this scenario is to utilize storage capability of PNW hydro generation to shape the solar generation in California to reduce curtailment of solar output.

4.2.1 Near-term Assessment – 5,100 MW North to South Flow on COI

Two study cases were developed for this assessment; Energy Transfer and Resource Shaping:

Energy Transfer (N-S):

- COI = 5,100 MW N-S, PDCI = 3,210 MW N-S, other paths based on historical data;
- Late afternoon, early evening hours in hot summer days in California in which it is expected that the California load is close to its net-peak load;
- California solar generation is close to zero; and,
- Plant outages in the desert Southwest.

Resource Shaping (N-S):

- COI = 5,100 MW N-S, PDCI = 3,210 MW N-S, other paths based on historical data;
- Late afternoon, early evening hours in early spring in which highest California demand ramp rate is expected due to drop in solar generation;
- California solar generation is close to zero; and,
- California load is around 60% of its peak load.

The following table shows a summary of the base cases for these two study scenarios:

Table 4.2-1: Parameters of the COI = 5,100 MW N-S study scenarios

Case Name	2023HS_ET_N-S_R2.sav	2023SOP_RS_N-S_R2.sav
Case Description	High import from PNW to CA to serve energy in California	High import from PNW to CA for Resource Shaping in early evening in Spring
Year/Season	2023, Late Summer	2023, Spring, early evening
Initial WECC Case	23HS2a1	23HW1a1
COI (66)	5,105 MW (N-S)	5,100 MW (N-S)
PDCI (65)	3,210 MW (N-S)	3,210 MW (N-S)
Path 15	1,520 MW (N-S)	500 MW (N-S)
Path 26	3,490 MW (N-S)	1,540 MW (N-S)
Path 46	7,360 MW (E-W)	4,190 MW (E-W)
Path 76	0 MW	0 MW
IPP (27)	1,720 MW (E-W)	640 MW (E-W)
NW-BC (Path 3)	2,160 MW (N-S)	2,510 MW (N-S)
ISO Load	~ 95% of peak load	~ 60% of peak load
ISO Solar	~ 0	~ 0
ISO Wind	~ 60%	~ 60%
Total ISO Import	13,260 MW	8,900 MW
Northern California Hydro	2,440 MW (60%)	1,700 MW (42%)

4.2.1.1 Northern California Hydro Generation Assumptions

To test system performance under stressed scenarios, northern California hydro generation is typically dispatched at 80% of their capacity. However in this special study, the objective was to test the system under favorable conditions rather than a stressed scenario. A review of northern California Hydro output in the last 5 years was performed in late afternoon/early evening hours in summer and spring. The median values of northern California hydro generation as a percentage of installed capacity are shown in Figure 4.2-1. Based on this analysis, northern California hydro generation was assumed to be around 60% and 40% for summer and spring study cases respectively.

Figure 4.2-1: Median of Historical Northern California Hydro Generation in the Study Hours

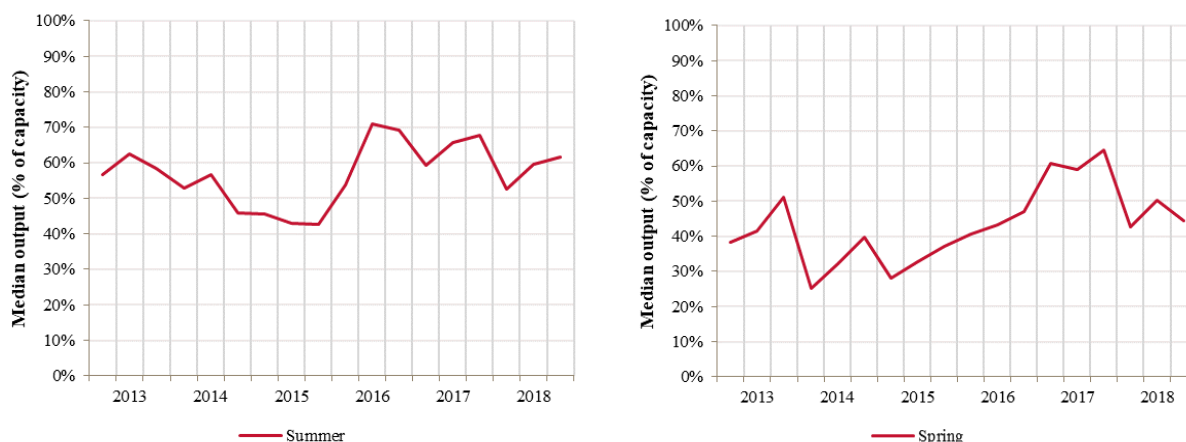

4.2.1.2 Analysis of COI = 5,100 MW N-S Energy Transfer Case (Summer)

One important check in setting up study cases with high COI flows is the “COI pick-up” following the trip of one Palo Verde unit. Historically, following the trip of one Palo Verde unit, 42% - 45% of its generation shows up on COI and base cases are typically set up in the studies to reflect that. However, in this study, the COI pick-up is around 38% of one Palo Verde unit. The reason is that hydro generation in the PNW is high and, as a result, the generators don’t have large amounts of headroom to respond to generation tripping. Note that in addition to the COI flow of 5,100 MW, PDCI is dispatched at 3,210 MW. High export along with relatively high load in the NW (summer evening) requires high hydro output.

As COI flow increases beyond a certain threshold, the RAS to drop generation in the PNW system is armed to address reliability issues for the simultaneous (P7) outage of two adjacent 500 kV lines. At maximum COI flow of 4,800 MW, around 2,400 MW generation in PNW is armed for the RAS. If the contingency categorization remains P7 and the RAS arming amount doesn’t change, the maximum COI flow limit will remain 4,800 MW.

One approach to increase the COI capacity is to treat the simultaneous outage of two adjacent circuits as conditionally credible, in which the outage is considered a P6 (N-1-1) contingency unless certain high risk weather or fire conditions exist that makes them a credible P7 contingency. This study showed that with this approach, COI flow could be increased to 5,100 MW before any criteria violations occur. At 5,100 MW COI flow, the N-1 outage of the Round Mountain – Table Mountain 500 kV line loaded the remaining line at 100%. Therefore, under favorable conditions, COI flow could be set at 5,100 MW. Study results show that with COI flow at 5,100 MW, a simultaneous outage of Malin – Round Mountain #1 and #2 500 kV lines, caused a 10% overload on the Captain Jack – Olinda 500 kV line. Note that if COI is at 5,100 MW on this basis, this double outage would be considered not to be credible and therefore is equivalent of an Extreme Event for which planning solutions are not required by NERC or WECC standards.

Another approach to increase COI to 5,100 MW is to increase generation tripping in the PNW or include load shedding in California following the N-2 contingency. BPA has indicated that increasing generation tripping in the PNW could be challenging. Currently there are number of load shedding schemes in service in California to address reliability issues. By adding load shedding to the COI RAS, it would be possible to increase COI to 5,100 MW to address thermal overloads following N-2 contingencies. Details of the load shedding scheme such as magnitude and location should be defined in future studies.

No voltage issue and voltage or dynamic stability criteria violations were identified for the energy transfer case.

Studies Conducted by BPA on PNW System

Figure 4.2-2 shows a schematic diagram of the BPA system connecting to California. Study results showed that in determining the total NW net export, the critical condition is the double outage of the John Day – Grizzly #1 and Buckley – Grizzly 500 kV lines overloading the John Day – Grizzly #2 500 kV line. There are number of factors impacting the maximum COI flow:

- Path 75 (Hemingway – Summer Lake) flow
- P76 (Alturas Project) flow
- Redmod Import
- Klamath Falls generation
- The rating of the John Day – Grizzly #2 500 kV line

COI flow could be higher with lower exports on P75, P76, and Redmond while Klamath Falls generation is high

Figure 4.2-2: Schematic Diagram of BPA system connecting to California

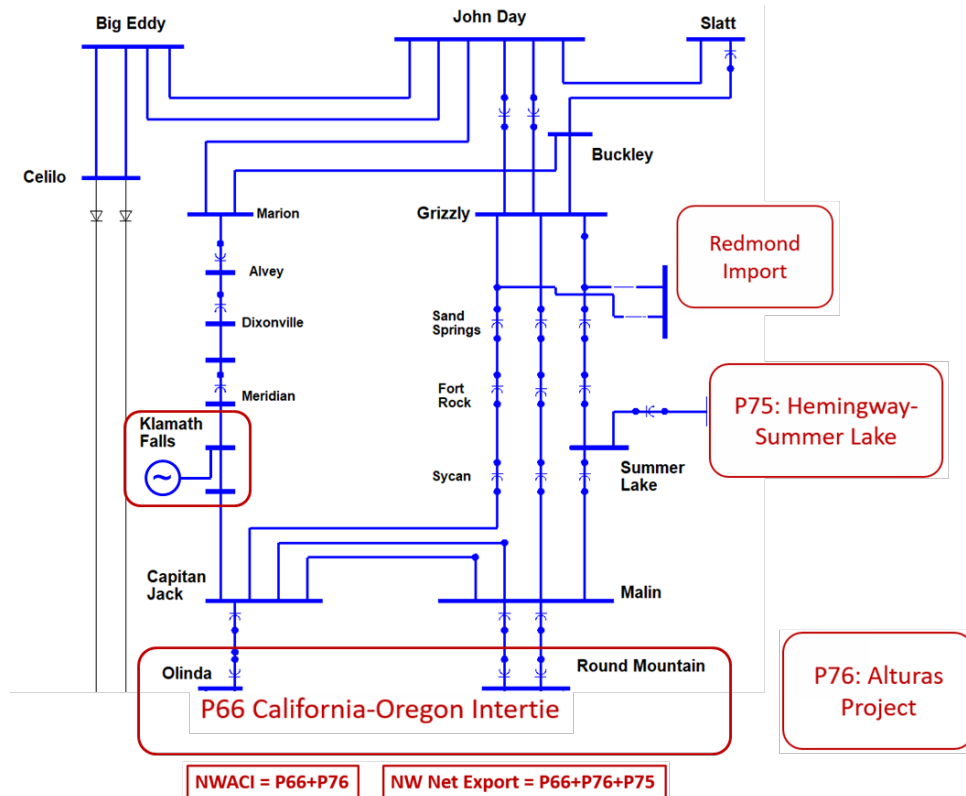

BPA performed a detailed study to quantify the correlation between the parameters impacting the NW Net Export capability. Figure 4.2-3 shows that a total of 5,100 MW on COI and Path 76 is achievable under a wide range of Path 75 flows when Klamath Falls generation is dispatched at high levels, which based on historical data is expected to be the case in summer months.

Figure 4.2-3: NW export capability vs. total COI + Path 76 flow

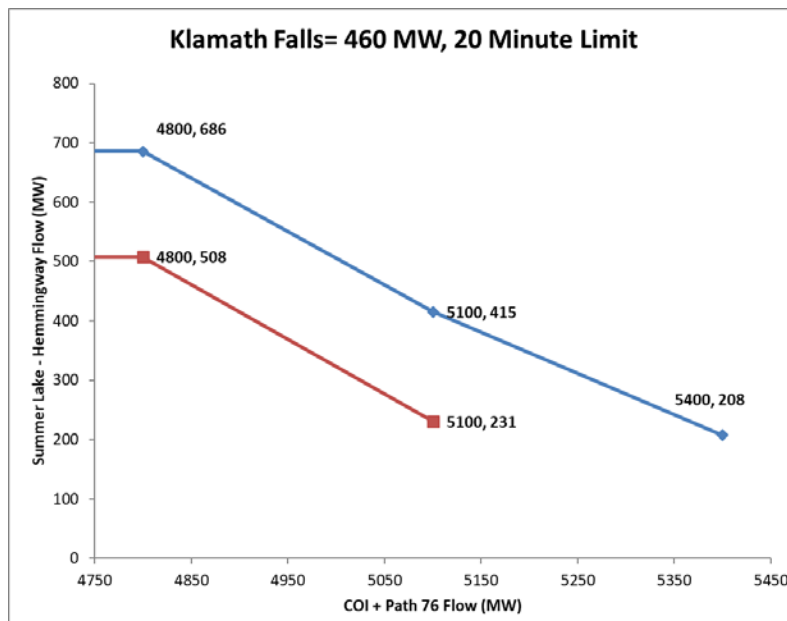

4.2.1.3 Analysis of COI = 5,100 MW N-S Resource Shaping Case (Spring)

The “COI pick-up” test following the trip of one Palo Verde unit was around 51% of the lost generation, which is higher than the historically typical 42% - 45% range. The reason is that this scenario is a spring evening case and, as a result, many California thermal generators are offline and don’t respond to lost generation. On the other hand, high export on COI and PDCI requires high hydro generation in the PNW with relative low spring load, which results in high hydro generation headroom.

Similar to the Energy Transfer case in summer, if the contingency categorization of two adjacent circuits remains P7 and the RAS arming amount doesn’t change, the maximum COI flow limit will remain 4,800 MW. However by treating the simultaneous outage of two adjacent 500 kV line as conditionally credible, COI flow could be increased to 5,100 MW at which the N-1 outage of the Round Mountain – Table Mountain 500 kV line loads the remaining line at 100%. Study results showed that with COI flow at 5,100 MW, a simultaneous outage of Malin – Round Mountain #1 and #2 500 kV lines, caused an 18% overload on Captain Jack – Olinda 500 kV line and as a result the voltage along the Olinda – Tracy 500 kV path would be low. Note that if COI is at 5,100 MW, this double outage is considered not to be credible and therefore is equivalent of an Extreme Event for which planning solutions are not required by NERC or WECC standards.

Another approach to increase COI to 5,100 MW in the Resource Shaping case in spring, is to increase generation tripping in the PNW or include load shedding in California following the N-2 contingency. BPA has indicated that increasing generation tripping in the PNW could be challenging. Currently there are number of load shedding schemes in service in California to address reliability issues. By adding load shedding to the COI RAS, it would be possible to increase COI to 5,100 MW to address thermal overloads and voltage issues following N-2 contingencies. Details of the load shedding scheme such as magnitude and location should be defined in future studies. If required, voltage issues could also be addressed by utilizing Fast AC Reactive Insertion (FACRI) scheme in the PNW system which could be utilized under extreme events such as simultaneous outage of two 500 kV lines when it was deemed not credible.

Studies Conducted by BPA on PNW System

BPA studies showed that there were no thermal overload issues for a wide range of Path 75 flows with 5,100 MW simultaneous flow on COI and Path 76. Also, there were no voltage or voltage stability issues in the system with proper switching of existing reactive support devices in the system.

4.2.2 Near-term Assessment – South to North Flow on PDCI and COI

Three study cases were developed for this assessment; two for the Energy Transfer scenario and one for the Resource Shaping scenario:

Energy Transfer (S-N) (two cases):

- Late afternoon hours in the fall with mild temperatures in California and cooler weather in PNW. California load is expected to be 60% of its peak load with solar generation at around 80% of peak and wind generation in southern California at around 70% of its peak. With high solar and wind generation and low load in California it is expected that surplus generation to be available to export of PNW.
- Case A: PDCI = 1,000 MW S-N, COI = 3,627 MW S-N, typical on other paths
- Case B: PDCI = 1,500 MW S-N, COI = 2,543 MW S-N, typical on other paths.

Resource Shaping (S-N):

- Middle of the day in the spring with mild temperatures in California and cooler weather in PNW. California load is expected to be 60% of its peak load with solar generation at around 100% of peak and wind generation in southern California at around 70% of its peak. With high solar and wind generation and low load in California it is expected that surplus generation to be available to export of PNW.
- PDCI = 1,500 MW S-N, COI = 2,725 MW S-N, typical on other paths

The following table shows a summary of the base cases for these S-N study scenarios:

Table 4.2-2: Parameters of the PDCI south to north study scenarios

Case Name	2023falloffpk_etr_pdc1000sn_v2.sav	2023falloffpk_etr_pdc1500sn_v2.sav	2023sop_rs_pdc1500sn_v2.sav
Case Description	Fall offpeak energy transfer from California to the Pacific Northwest with PDCI flow at 1,000 MW (S-N) and with COI at 3,627 MW (S-N)	Fall offpeak energy transfer from California to the Pacific Northwest with PDCI flow at 1,500 MW (S-N) and with COI at 2,543 MW (S-N)	Spring off-peak energy shaping with PDCI at 1500 MW (S-N direction) and COI at 2,725 MW (S-N)
Year/Season	2023, late fall	2023, late fall	Early spring 2023, around noon
Initial WECC Case	23HW1a1	23HW1a1	23HW1a1
COI (66)	3,627 MW (S-N)	2,543 MW (S-N)	2,725 MW (S-N)
PDCI (65)	1,000 MW (S-N)	1,500 MW (S-N)	1,500 MW (S-N)
Path 15	3,972 MW (S-N)	2,296 MW (S-N)	1,403 MW (S-N)
Path 26	661 MW (S-N)	239 MW (S-N)	1,120 MW (N-S)
Path 46	7,276 MW (E-W)	7,435 MW (E-W)	5,088 MW (E-W)
Path 76	114 MW (N-S)	114 MW (N-S)	115 MW (N-S)
IPP (27)	1,575 MW (E-W)	1,575 MW (E-W)	1,575 MW (E-W)
NW-BC (Path 3)	1,408 MW (S-N)	1,405 MW (S-N)	1,400 MW (S-N)
ISO Load	~ 61% of peak load	~ 61% of peak load	~60% of peak load
ISO Solar	80%	80%	100%
ISO Wind	~ 69% (SoCal), 3% (PG&E)	~ 69% (SoCal), 3% (PG&E)	~ 69% (SoCal), 3% (PG&E)
Total ISO Import	-238 MW (export)	-260 MW (export)	-2,927 MW (export)
Northern California Hydro	1,513 MW (37%)	1,513 MW (37%)	1,513 MW (37%)

4.2.2.1 Northern California Hydro Generation Assumptions

The northern Californian hydro generation is not as critical when COI is in the south to north direction, compared to the north to south studies, as it doesn't impact COI limit and therefore it wasn't adjusted from the original WECC case.

4.2.2.2 Analysis of South-to-North Near-term Assessment Results

For the overlapping contingencies (N-1-1) or N-2 (WECC Common Corridor) of 500 kV lines in the same corridor but not on the same tower the transmission contingency of Adelanto-Toluca and Victorville-Rinaldi 500 kV lines are the most severe outage. Study results showed no overloading or voltage or transient stability concerns.

For the extreme contingency of N-2-1 of Rinaldi-Tarzana 230 kV #1 and 2 lines, followed by Northridge-Tarzana 230 kV line, a number of 138 kV lines within LADWP's transmission system overload. These overloads are existing local area reliability concerns that stemmed from having no local generation dispatched. A potential mitigation for this issue is to dispatch local generation post first contingency to prepare for the next contingency.

For 500 kV bulk contingencies treated as either P6 or P7 of 500 kV lines in the same corridor but not on the same tower in northern California, various 230 kV line overloads were observed that are addressed by existing RAS schemes (i.e., inserting line series reactor on 230 kV line). The Olinda 500/230kV transformer also overloaded for the 1000 MW PDCI S-N study case that could be mitigated by generation curtailments through existing or new RAS schemes to trip generation (as a P7 contingency) or by system readjustment after first contingency (as a P6 contingency).

4.2.2.3 Analysis of South-to-North Near-term Assessment Results (Sensitivity Studies)

In addition to the baseline scenarios, three sensitivity studies were also assessed as follows, based on the Resource Shaping case:

- Case 1: 1500 MW PDCI S-N resource shaping, spring off-peak, solar generation at 100% installed capacity, additional loads include 600 MW Castaic pump loads
- Case 2: Started with Case 1 and changed PDCI dispatch to 1,050 MW S-N
- Case 3: Started with the 1500 MW PDCI S-N resource shaping, and switched off Klamath Falls generation to reflect spring condition; this case had an earlier assumption of having local generation dispatch in LADWP's LA Basin.

For Case 1, the Rinaldi 500/230kV Bank H and the Century – Victorville 287kV line were overloaded for the overlapping contingencies (N-1-1) or N-2 (WECC Common Corridor) of Adelanto-Toluca and Victorville-Rinaldi 500 kV lines.

For the extreme contingency of N-2-1 of Rinaldi-Tarzana 230kV #1 and 2 lines, followed by Northridge-Tarzana 230kV line. Thermal loading concerns on various 138kV lines internally within LADWP's transmission system. These are existing local area reliability concerns due to having

no local generation dispatched. A potential mitigation is to dispatch local generation post first contingency to prepare for the next contingency for the extreme outage loading concerns.

For 500 kV bulk contingencies treated as either P6 or P7 of 500 kV lines in the same corridor but not on the same tower in northern California, various 230 kV line congestion occurs. There are existing RAS schemes to mitigate the local congestion concerns in northern California (i.e., inserting a line series reactor on 230 kV lines, opening 500/230 kV circuit breakers at Round Mountain.) For other local congestion concerns in northern California, either include generation curtailments to either existing or new RAS schemes to trip generation (P7 contingencies) or implement congestion management protocol for overlapping P6 contingencies.

The Olinda 500/230kV and Round Mountain 500/230kV transformers are also overloaded for 500 kV bulk contingencies. These overloads could be mitigated by generation curtailments through existing or new RAS schemes to trip generation (as a P7 contingency) or by system readjustment after first contingency (as a P6 contingency).

The following conceptual mitigation options could help maintaining PDCI schedules and imports into LADWP under critical contingencies:

- Install two 230kV phase shifters with 540 MVA, 0 to -40° phase angles on the Sylmar-Gould 230kV line at Sylmar end (note that there are variations on locations for the phase shifters); OR,
- Install RAS to trip pump loads (this mitigation option is not favored by LADWP.)

The following conceptual operating mitigations are provided here for information only. the ISO notes that LADWP retains jurisdictional responsibility for proposing and implementing operating actions. These options may involve curtailing schedules or loads under critical contingencies:

- Potential operating actions to curtail pump loads after the first contingency;
- Potential operating actions to reduce PDCI S-N flow to 1,000 MW after the first contingency; OR,
- Potential operating actions for implementing System Operating Limit (SOL) for VIC-LA path.

4.2.2.4 Summary of Near-term Assessment Results

- In the north to south flow:
 - With N-2 treatment of contingency loss of 500 kV lines in adjacent circuits, COI limit will remain 4,800 MW unless new generation or load shedding is included in the RAS.
 - If the outage of two 500 kV adjacent lines were to be considered conditionally credible contingencies (i.e., as P6), the COI limit could potentially increase to 5,100 MW under favorable conditions.
 - Further studies are required for a COI limit beyond 5,100 MW

- In the south to north flow:
 - COI flow up to the WECC limit of 3,675 MW S-N is feasible for certain conditions with typical fall and spring off-peak conditions.
 - PDCI flow is currently limited to 1000 MW S-N operationally by LADWP to address most, if not all, winter operating conditions. LADWP is the operating agent for the PDCI at the southern terminal.
 - However, under certain fall and spring off-peak light load scenarios, PDCI S-N flow could be operated higher (i.e., 1,500 MW) under normal conditions. Under critical contingency conditions, the PDCI S-N flow would need to be reduced to its 1,000 MW limit.
 - Potential transmission upgrades, such as phase shifting transformers, could be an option for providing imports for LADWP via the Sylmar path while maintaining PDCI S-N flow at 1,500 MW. This is exploratory at this time and would need further assessments of engineering and operational feasibility.

4.3 Long-term Assessment (Year 2028)

In the long-term assessment for the year 2028, the objective was to perform production cost modeling simulations to estimate the potential benefits of increased AC and DC transfer capability. Assumptions on the profile of hydro generation in the PNW was a critical component of this study. The ISO received hydro information from Northwest Power and Conservation Council (NWPCC) and updated PNW hydro models in the production cost model to reflect the updated information.

4.3.1 PNW Hydro Model in Production Cost Model (PCM)

The WECC Anchor Data Set (ADS) was used as a starting point for the production simulation analysis using ABB GridView software. Hydro assumptions in the ADS are based on historical hydro output in WECC from 2008/2009. Using publicly available information on BPA hydro generation, the BPA hydro generation output from of the 2028 PCM was compared with actual BPA generation and the results are provided in Figure 4.3-2. The 2028 PCM provides similar seasonal hydro generation variations as year 2008 actual output, while there are some differences compared to year 2017 actual output.

Figure 4.3-1: Comparison between actual BPA generation and production simulation results

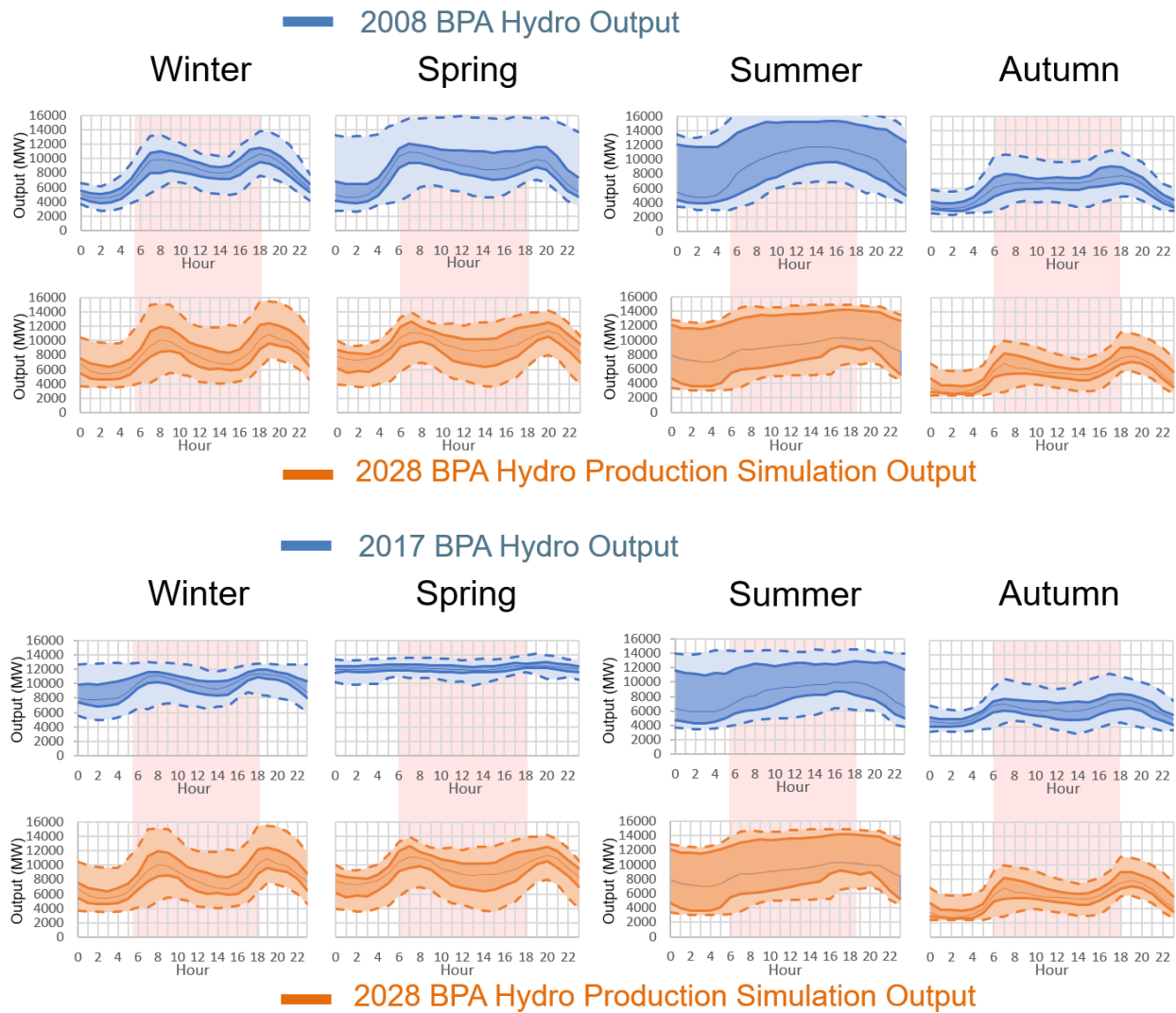

The ISO also reached out to the northwest planning regions (ColumbiaGrid and Northern Tier Transmission Group) and the hydro owners to review hydro modeling in the ADS and make updates as required. The ISO received information on typical (medium), high, and low hydro scenarios from NWPCC and BPA4. NWPCC’s GENESYS model provides a chronological hourly simulation of the Pacific NW power supply that includes 34,086 MW of installed hydro capacity.

4 California ISO, Northwest Power and Conservation Council and Bonneville Power Authority. September 6th Portland Stakeholder Workshop. 2018. Available here: https://gridworks.org/wp-content/uploads/2018/09/Sharing-Power_Slide-Deck_Sept-6.pdf

BPA. Wind generation & total load in the BPA balancing authority. 2018. Available here: <https://transmission.bpa.gov/Business/Operations/Wind/default.aspx>

US Army Corps of Engineers. Dataquery 2.0. 2018. Available here: <http://www.nwd-wc.usace.army.mil/dd/common/dataquery/www/#>

GENESYS is used by NWPCC for assessing resource adequacy in the Pacific Northwest and considers the non-power requirements of the northwest hydro.

The GENESYS model provides monthly total hydro generation based on water flow patterns for 80 years from 1929 to 2008. To study system performance under high, low, and medium hydro conditions, water flow patterns of years 1931, 1960, 1997 were selected that correspond to 5th, 50th, and 95th percentile of hydro generation. Figure 4.3-2 shows the monthly hydro generation under each hydro scenario along with the PNW hydro model in the ADS for comparison. The total energy generated in a year is 100, 148, and 172 TWh for low, medium, and high water conditions.

Figure 4.3-2: Monthly Hydro Generation under High, Low, and Medium hydro years



4.3.1.1 Updating ADS hydro modeling parameters

The information provided by NWPCC was an aggregate of all the hydro units in the PNW system. GridView software requires the following information for each unit:

- Monthly energy (MWh)
- Monthly max output (MW)
- Monthly min output for each year (MW)
- Monthly daily average operating range (MW)

For the majority of the PNW units, the rated capacity of each unit was used to calculate the above parameters for the unit, on a pro-rata basis from the NWPCC aggregated values. The only exceptions were the Federal Columbia River Power System Mainstem units that include a total of

6 projects as shown in Figure 4.3-3: Grand Coulee, Chief Joseph, McNary, Bonneville, John Day and The Dalles. For these units, the monthly energy was still obtained on pro-rata basis, and monthly maximum energy, monthly minimum energy, and daily operating range parameters were estimated based on historical data. Figure 4.3-4, Figure 4.3-5, and Figure 4.3-6 show these estimated parameters for Mainstem units for each month in high, low, and medium hydro years.

Figure 4.3-3: Location, Capacity, and Energy of Mainstem Units

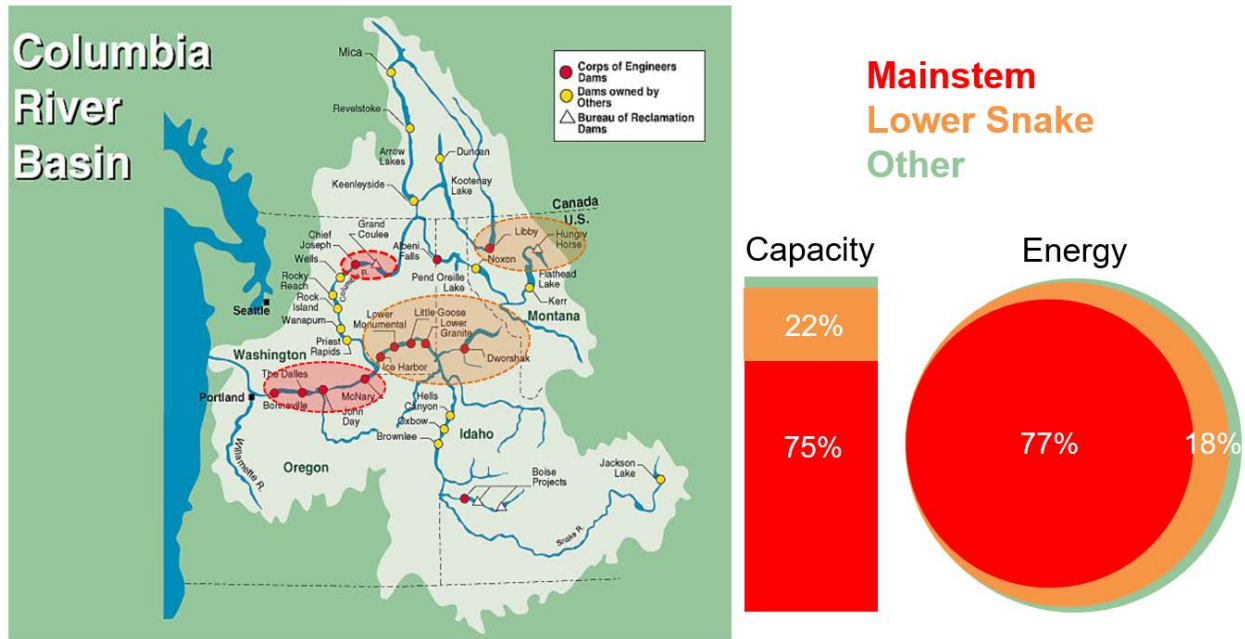

Figure 4.3-4: Min, Max, and Daily Operating Range for Mainstem Units for Medium Hydro Years

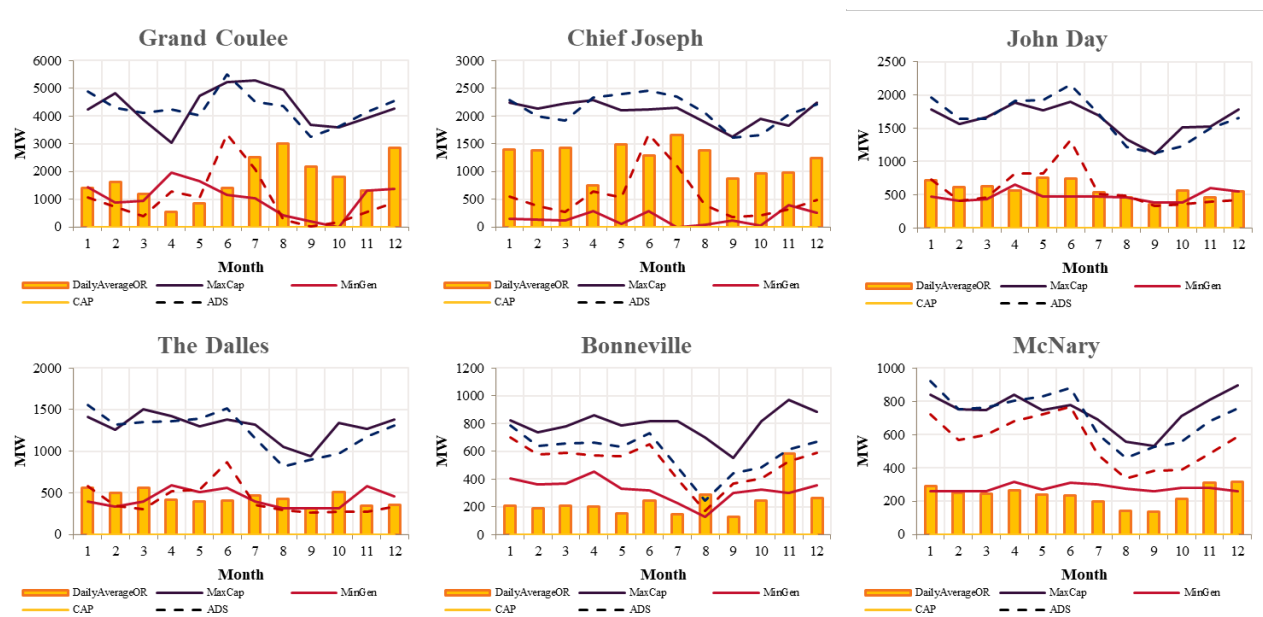

Figure 4.3-5: Min, Max, and Daily Operating Range for Mainstem Units for High Hydro Years

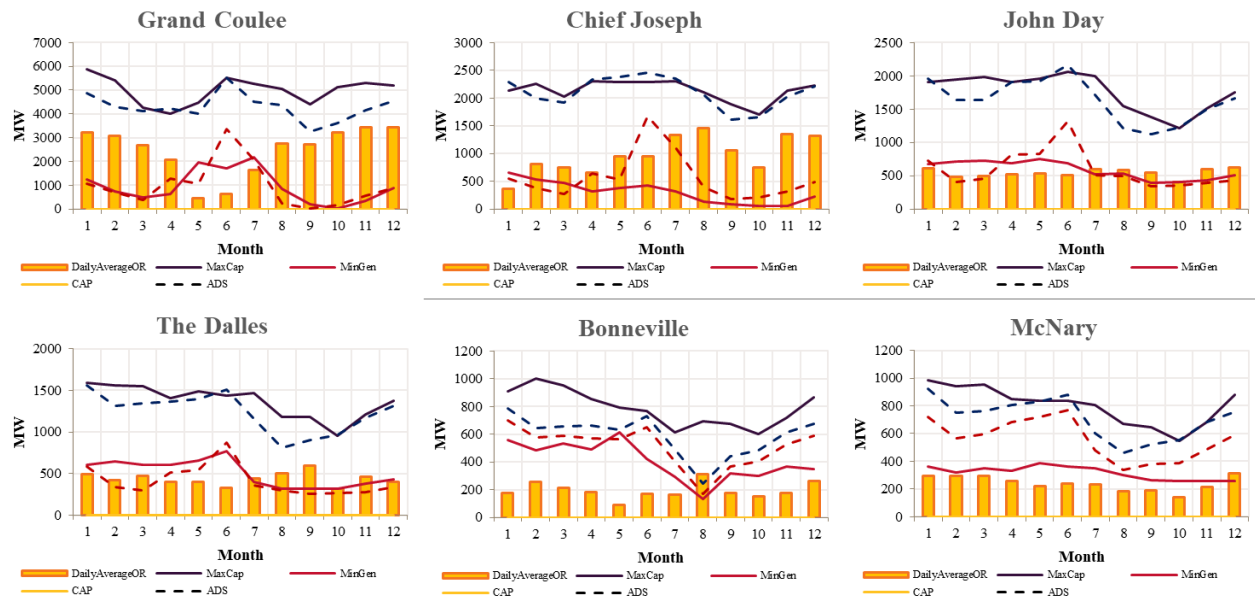
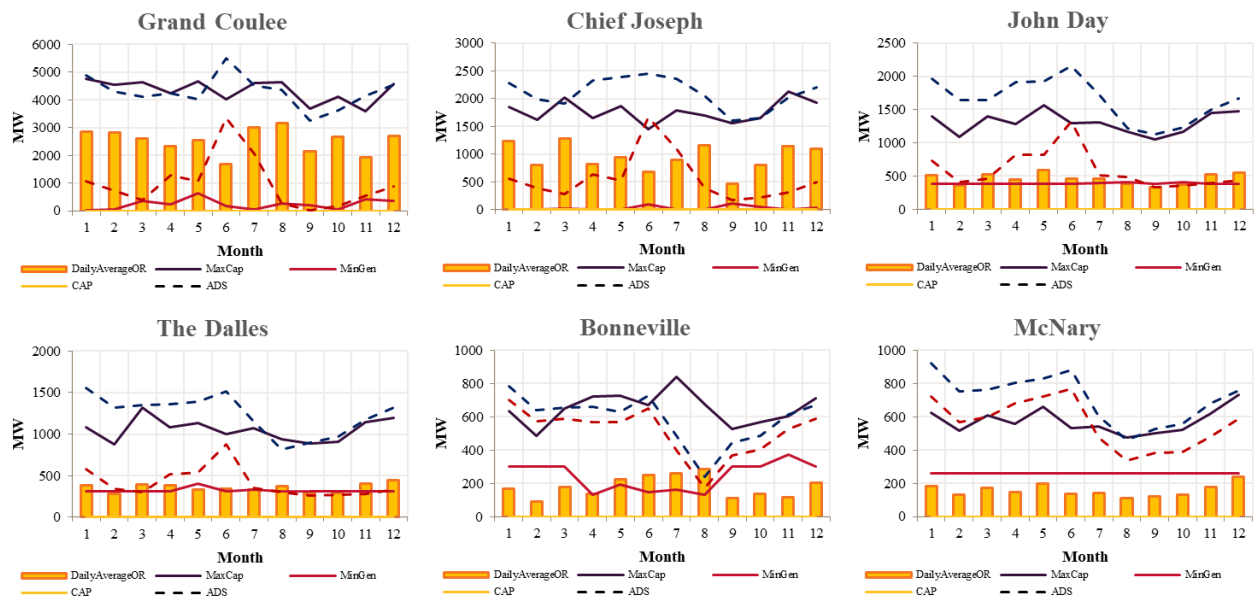

Figure 4.3-6: Min, Max, and Daily Operating Range for Mainstem Units for Low Hydro Years



4.3.2 Analysis of Long-term Assessment Results

Production cost modeling simulations were carried out on the ISO's current PCM as a reference, as well as the three updated scenarios for high, low and medium hydro years. The focus of this analysis was to assess the congestion on COI and PDCI. In addition to these two paths, the congestion on Path 26 was also examined to evaluate the impact of operating limits on PDCI in the south to north direction.

4.3.2.1 COI Congestion with Different Hydro Conditions

In the baseline scenario of the production simulation studies, the COI path rating is the current rating of 4800 MW in north-south and 3675 MW in the south-north direction. Table 4.3-3 shows the number of hours that COI was congested under different hydro conditions. Note that COI scheduled outages and derates are modeled in the production cost model and COI congestion mainly happened during the hours in which COI was derated. The COI congestion includes the congestion of Path 66 (COI) itself as well as its downstream transmission lines. A sensitivity study was performed on the medium hydro conditions assuming N-S COI path rating was 5,100 MW. Production simulation results indicated that the COI congested hours decreased from 387 hours in the baseline scenario with a 4,800 MW COI rating down to 281 hour in the sensitivity scenario with a 5,100 MW COI rating.

Table 4.3-3: COI congestion in year 2028 production simulation

	ISO Planning PCM	Medium	Low	High	ISO Planning PCM with 5100 MW COI rating	Medium with 5100 MW COI rating
Congestion Hour	165	387	98	482	132	281
Congestion Cost (\$M)	5.06	13.36	1.92	20.70	6.07	11.47

The production benefit for the ISO's ratepayers and the WECC overall production cost savings of increasing the COI path rating to 5100 MW are shown in Table 7.1-4. The PNW Medium hydro condition was used in this assessment. This assessment showed production benefit to the ISO's ratepayers, which differs from the results in section 4.9.1.1 of the ISO's 2018-2019 Transmission Plan. This is mainly because the PNW Medium hydro condition has higher annual energy than the PNW hydro condition that was modeled in the WECC ADS and used as the baseline assumption in the ISO's economic planning study in the 2018-2019 Transmission Plan. It is worth noting that the PCM for PNW-CA study allowed hydro generators to response to system-wide LMP to reflect the potential coordination between the hydro and renewable operations. In the WECC ADS and ISO economic planning PCM, hydro generators only responded to local LMP.

Table 7.1-4: Production Cost Modeling Results for COI path rating at 5100 MW, PNW Medium Hydro condition

	Pre project upgrade (\$M)	Post project upgrade (\$M)	Savings (\$M)
ISO load payment	8,083	8,065	18
ISO owned generation profits	2,150	2,146	4
ISO owned transmission revenue	190	187	3
ISO Net payment	5,743	5,732	11
WECC Production cost	16,172	16,173	-1

Note that ISO ratepayer “savings” are a decrease in load payment, but an increase in ISO owned generation profits and an increase in ISO owned transmission revenue. WECC-wide “Savings” are a decrease in overall production cost. A negative saving is an incremental cost or loss.

In the ISO planning PCM, the PDCI rating in the south to north direction was assumed to be 1050 MW to be consistent with LADWP’s operation limit on this path. A sensitivity study assuming the WECC PDCI rating that is 3100 MW in the south to north direction was conducted to assess the impact of the PDCI rating in the south to north direction, on the PDCI congestion. Table 7.1-5 shows that PDCI was not congested in many hours even when the 1050 MW rating was used. The PDCI rating increase helped to reduce Path 26 congestion hours from 1029 hours to 1022 hours. Path 26 congestion costs may change in either direction depending on the LMPs change on the both side of the path, which were decided by the generation dispatch in each hour.

The ISO net export limit also constrained flow through PDCI from south to north. Table 7.1-6 shows the PDCI and Path 26 congestions when the ISO net export limit was not enforced. PDCI congestion hours were reduced from more than 300 hours to zero when the PDCI rating was increased from 1050 MW to 3100 MW. In this sensitivity study, the PDCI path rating increase resulted in Path 26 congestion reduction from 1115 hours to 1091 hours.

Table 4.3-5: Path 26 and PDCI congestion in year 2028 production simulation – 2000 MW ISO net export limit scenario

PDCI Limit (MW)	PAC NW Hydro	Path 26 Congestion Cost (\$M)	Path 26 Congestion Hours	PDCI Congestion Cost (\$M)	PDCI Congestion Hours
3100	ISO Planning PCM	27.75	1022	0	0
1050	ISO Planning PCM	25.0	1029	0.5	76
3100	Medium	21.09	974	0	0
1050	Medium	21.98	1005	0.41	82

Table 4.3-6: Path 26 and PDCI congestion in year 2028 production simulation – No ISO net export limit scenario

PDCI Limit	PAC NW Hydro	Path 26 Congestion Cost (\$M)	Path 26 Congestion Hours	PDCI Congestion Cost (\$M)	PDCI Congestion Hours
3100	ISO Planning PCM	41.28	1091	0	0
1050	ISO Planning PCM	43.66	1115	2.97	385
3100	Medium	34.44	1,001	0	0
1050	Medium	36.79	1046	2.41	388

4.3.3 Summary of Longer-term Assessment Results

In the north to south flow:

- COI congestion occurs in all hydro conditions with highest congestion occurring in “high hydro” scenario; and,
- No congestion was observed on PDCI in the N-S direction.

In the south to north flow:

- No congestion on COI was observed in the S-N direction;
- No congestion on PDCI assuming WECC path rating as the limit. There would be congestion on PDCI if the S-N is limited to 1050 MW; and
- Path 26 is congested for more than 1,000 hours in the S-N direction for the medium hydro scenario.

5 Increase Dynamic Transfer Capability (DTC)

This section provides a summary of DTC limitations and the mitigation measures BPA is considering to address them. The details are provided in “BPA DTC Roadmap” in Attachment 1

Dynamic transfer capability refers to the capability of the Pacific Northwest system to accommodate variations on 5-minute scheduling on Pacific Northwest AC Interties (NWACI). Currently the DTC on NWACI is limited to 600 MW mainly to prevent excessive voltage fluctuations and reactive switching. The current manual RAS arming process could become another limitation on DTC at higher levels. Voltage stability concerns were another DTC limiting factor until recently but the concerns have been addressed and they no longer limit DTC.

5.4 Excessive voltage fluctuations and reactive switching

Frequent variations in active power flows can cause excessive variations in customer voltages or switching of voltage control devices such as shunt reactors, capacitors and tap changers. “Customer voltage variations” limitations apply over the full range of COI transfers, and are more restrictive under high power transfers. Voltage variability is the limiting DTC factor about 80% of time today.

5.5 RAS Arming

RAS arming requirements increase at a steep rate between 2,500 MW and 3,600 MW of COI flow. The system can end up in an insecure state if dispatchers are unable to keep up with manual RAS arming.

5.6 Voltage Stability

Voltage stability was the limiting DTC factor about 20% of time, mainly under outage conditions. The reason was that a fast ramp up of the COI power may have resulted in a sub-optimal system state such that it may become voltage unstable for a critical contingency. However, the WECC Remedial Action Scheme Reliability Subcommittee (RASRS) approved BPA’s Synchrophasor RAS as wide-area protection effective December 1st, 2018 and as a result voltage stability is no longer a limit on DTC of NWACI. The Synchrophasor RAS addressed the issue as it identifies voltage stability risks using wide-area measurements and enables fast switching of shunt capacitors and reactors to improve stability.

5.7 Potential Solutions To Increase DTC

BPA is performing studies to evaluate potential solutions to increase the DTC.

Voltage Variability Limitation

Employ Real-time Allocation of DTC

DTC on COI is currently allocated in the day-ahead time frame. BPA is exploring applying the DTC limit in real-time on the net of all movements, instead of allocating DTC ahead of time, to allow significantly more dynamic usage within the same stated limits.

Apply DTC Limit to Actuals (instead of schedules)

BPA performed analysis of DTC usage, which indicated that actual five-minute flow variations on COI differ from DTC schedules. The actual change in flow is generally less than the magnitude of the corresponding schedule change. BPA is considering having the limit implemented by the operator of Western EIM (i.e. California ISO) based on actual physical flows as opposed to scheduled flows.

Use DTC Nomogram Instead of a Fixed Limit.

Voltage variability increases at higher COI flow following a classic Power-Voltage (PV) curve. Currently, BPA applies a single conservative limit corresponding to the high COI flows. A nomogram would be more appropriate to take advantage of greater DTC at lower COI levels.

Real-Time Voltage Assessment Tools

Real-time voltage assessment tools can be used to determine the dynamic transfer impact on customer voltage variability. However, based on a large number of sensitivity studies performed by BPA, the benefits of using real-time tools are likely to be minimal compared to the DTC nomogram.

Coordinated Voltage Controls

Further increases in DTC beyond 600 MW can be achieved by deploying Coordinated Voltage Controls (CVC). BPA has successfully implemented Automatic Reactive Controls (ARC) at wind generation hubs to coordinate switching of BPA shunt capacitors with voltage controls and reactive resources of wind farm. Proposed CVC will be similar in principle to ARC. Coordination with PG&E and TANC is required to achieve full utilization of COI DTC and ensure there are no voltage issues in their systems.

Control State Awareness and Analytics

Based on past experience with ARC, implementing CVC required state awareness tools to detect ramps and controller switching, as well as simulation tools to reproduce controller behavior.

BPA is planning to determine system enhancements, operating procedures, and analytical tools required to remove the DTC limitation in the Pacific Northwest system. Without DTC limitations, the 5-minute scheduling on COI will be similar to the 15-minute scheduling on which there are no limits on how much the schedule could change from one scheduling interval to the next.

6 Implementing sub-hourly scheduling on PDCI

Transfer scheduling on COI could currently be done on a 15-minute basis. Upon completion of DTC initiatives discussed earlier in this report, it would be possible to have 5-minute scheduling on COI without any technical limitations. With regards to PDCI, the scheduling can be done only on hourly basis. Having 5-minute or even 15-minute scheduling capability on PDCI would facilitate further utilization of PNW hydro to supply California load especially during morning and evening ramps in which the transfer requirements change quickly.

A number of modifications in both BPA and LADWP systems are required to facilitate sub-hourly scheduling on PDCI:

- AGC and EMS modifications at BPA system;
- Automation of PDCI RAS arming. BPA is working on this project with expected completion in 2020; and,
- Voltage variability: BPA performed initial system impact studies of PDCI dynamic transfers on the PNW system. The studies indicated increased switching of power factor correction capacitors at BPA and LADWP substations, and further analysis of switching device duty is required.

BPA will perform studies in 2019 to determine what AGC and other EMS modifications are required. System impact studies of simultaneous COI and PDCI 5-minute scheduling are planned in 2019 as well. Following up the completion of BPA studies, a joint BPA/LADWP study will be performed in order to fully assess what will need to be modified to automate the control of the DC from AGC systems. The joint study is expected to be completed in two years. The next steps will be decided based on the outcome of the studies.

System impact studies are also required to assess the impact of simultaneous COI and PDCI 5-minute scheduling. BPA is planning to perform these studies in 2019.

7 Assigning Resource Adequacy (RA) Value to firm zero-carbon imports

7.1 ISO's RA procurement process

The Maximum Import Capability is the quantity in MW determined by the ISO for each intertie into the ISO Balancing Authority Area to be deliverable to the ISO Balancing Authority Area and over which resource capacity can be procured by a load serving entity for meeting its resource adequacy capacity obligations. As part of annual Maximum Import Capability (MIC) determination process, the ISO calculates MIC on all branch groups (BG) based on the historical hour-ahead scheduled import on the BGs. This calculation is done annually, using the historical data over the prior two years. From all the hours in each year in which ISO load was higher than 90% of peak load in that year, the highest two scheduled imports will be selected (total of 4 data points for each BG). The average of the above four data points determines the MIC for any BG. The ISO posts the results of this annual analysis for all BGs on the ISO's website.⁵ From the available MIC, a portion of the capacity may have already been allocated to entities outside the ISO in the forms of Existing Transmission Contracts (ETCs) and Transmission Ownership Rights (TORs). The remaining capacity would be available to the Load Serving Entities (LSEs) in the ISO-controlled-grid to procure RA on the BGs. In the following sections, the MIC and available RA for the Malin 500 BG that is part of COI as well as Nevada-Oregon Border (NOB) which is part of PDCI is discussed in further detail.

7.2 Historical MIC allocation on the Malin 500 Branch Group

The Malin 500 BG consists of the Malin-Round Mountain #1 and #2 500 kV lines which are part of COI (Path 66). The Malin 500 BG maximum capacity is 3,200 MW, which is two thirds of COI's current WECC path rating of 4,800 MW. The MIC allocated to the Malin 500 BG in the last few years are provided in Table 5.7-, which shows that in last few years around 2,000 MW of capacity has been available on the Malin 500 BG to be used by LSEs for RA contracts from resources in the Pacific Northwest.

5

<http://www.caiso.com/Documents/ISOMaximumResourceAdequacyImportCapabilityforYear2019.pdf>

Table 5.7-7: Malin 500 BG MIC and Available RA for Internal ISO LSEs

Year	Max limit on Malin 500 BG MIC (MW) (2/3 rd s of COI limit)	Allocated MIC on Malin 500 BG (MW)	ETCs and TORs on Malin 500 BG held by entities outside the ISO (MW)	Available RA for Internal ISO LSEs (MW)
2015	2,983	2,913	880	2,033
2016	3,133	3,032	880	2,152
2017	3,127	3,008	900	2,108
2018	3,200	3,008	1,200	1,808

7.3 Historical RA showings on the Malin 500 Branch Group

The usage of available Malin 500 BG capacity for RA in the last few years is provided in Figure 5.7-1. The results show higher usage in summer months compared to other times of the year.

Figure 5.7-1: Malin 500 BG Maximum Monthly Usage by ISO LSEs

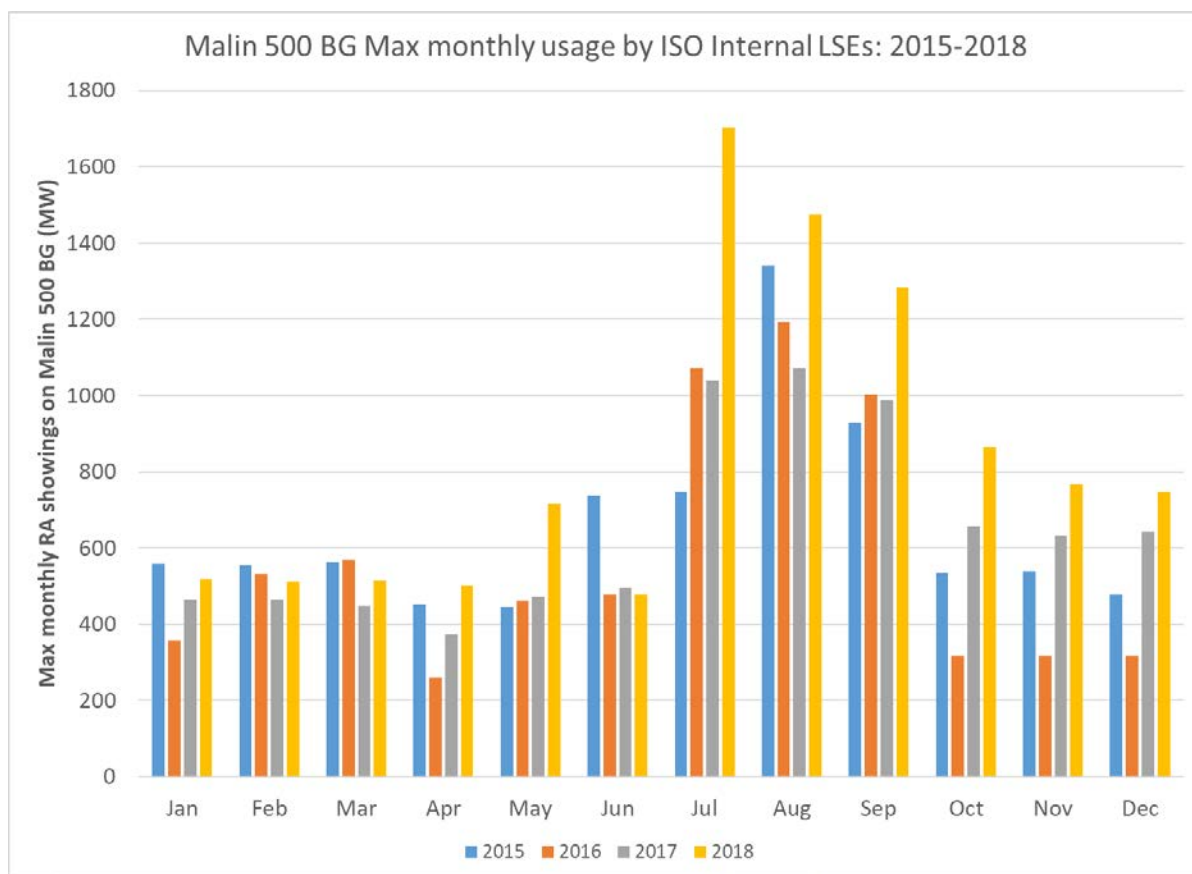

7.4 Historical MIC allocation on NOB Branch Group (PDCI)

The Nevada-Oregon Border (NOB) BG is basically the portion of the capacity of PDCI available to ISO. The allocated MIC allocated to the NOB BG in the last few years are provided in Table 5.7-84 which shows that in last few years, on average, around 1,400 MW of capacity has been available on the NOB BG to be used by LSEs for RA contracts from resources in the Pacific Northwest.

7.5 Historical RA showings on NOB Branch Group (PDCI)

The usage of available NOB BG capacity for RA in the last few years is provided in Figure 5.7-2. The results show higher usage in summer months compared to other times of the year.

Table 5.7-84: NOB BG MIC and Available RA for Internal ISO LSEs

Year	Max limit on NOB BG MIC (MW)	Allocated MIC on NOB BG (MW)	ETCs and TORs on NOB BG held by entities outside the ISO (MW)	Available RA on NOB BG for Internal ISO LSEs (MW)
2015	1,564	1,544	0	1,544
2016	1,564	1,544	0	1,544
2017	1,294	1,283	0	1,283
2018	1,294	1,270	0	1,270

Figure 5.7-1: NOB BG Maximum Monthly Usage by ISO LSEs

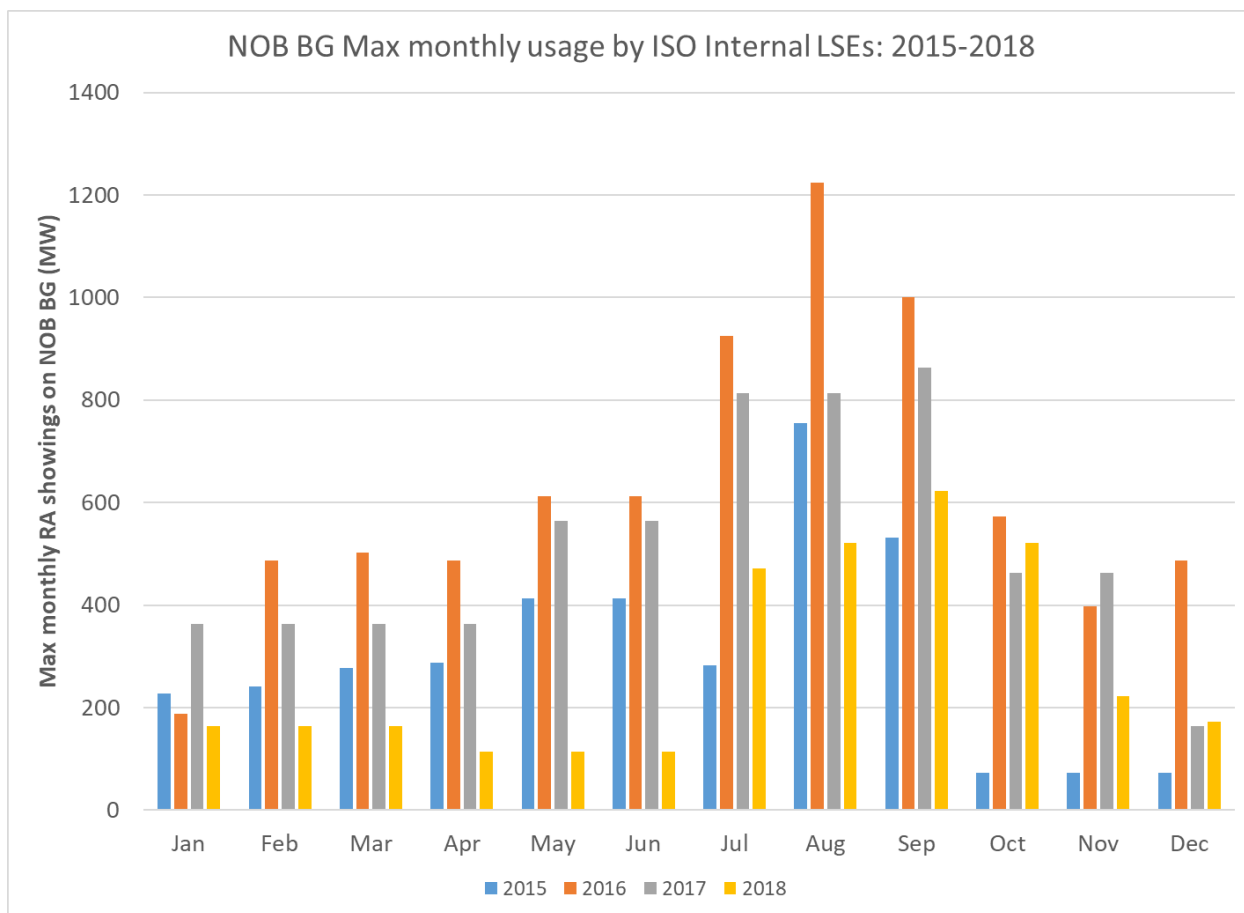

7.6 COI and PDCI Flows in Real Time

Figure 5.7-3 shows the daily variation of flows on COI and PDCI in March and August 2018. Each plot shows 0 (minimum), 10th, 25th, 50th (median), 75th, 90th and 100th (maximum) percentile of flows on COI and PDCI for any given hour of the day in March and August 2018.

Review of March data shows significant flows on both paths during hours without sunshine. Flows drop during the day with low load in California in March as well as significant solar generation. High flows at night are occurring despite relatively low RA showings in March.

Review of August data shows significant flows almost in all hours with slightly higher flows during evening ramp on both paths. This is in line with RA showings which are relatively higher in summer months.

Figure 7.6-1: Actual Daily Flows on COI and PDCI in March and August 2018

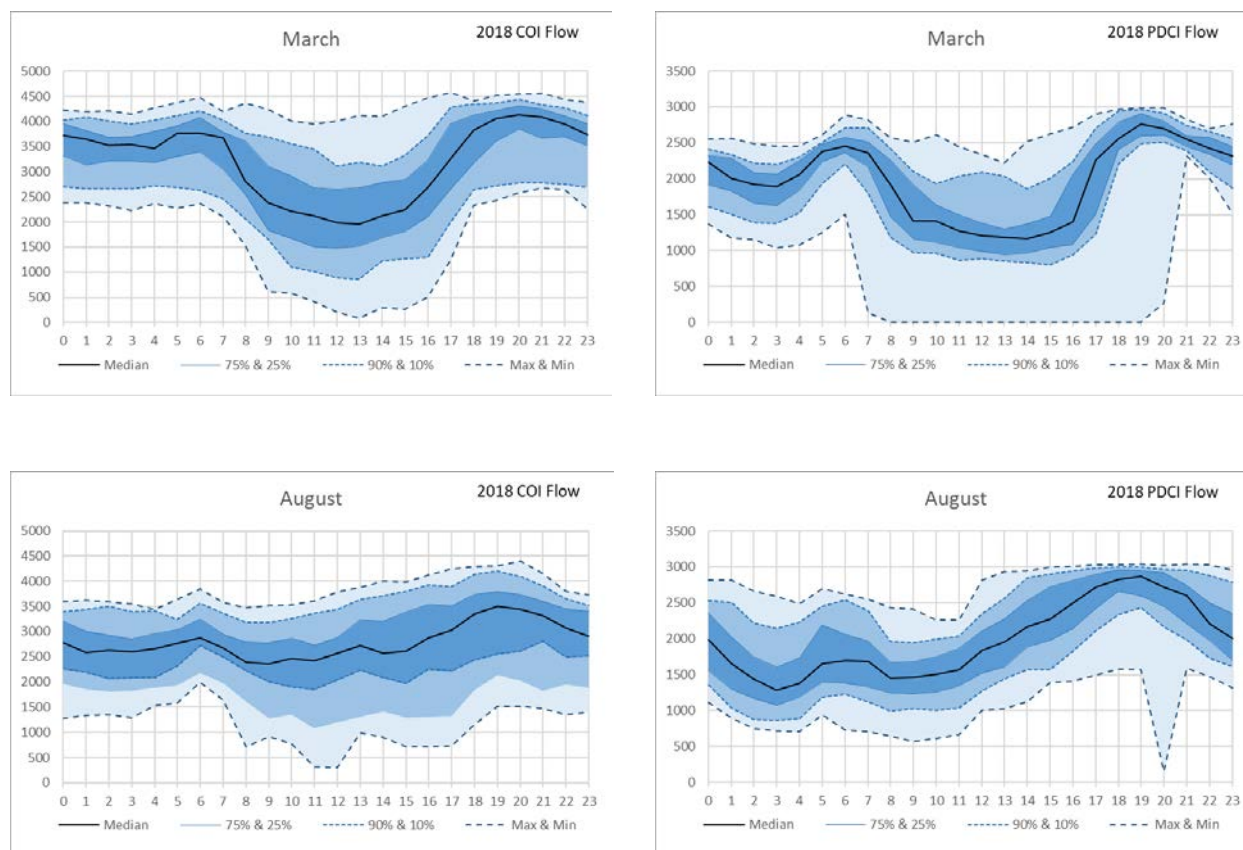

7.7 Potential barriers for higher RA showings

As per CPUC/ISO requirements, commitment of firm capacity is required 45 days ahead of the operating month in order to be counted towards RA. This might be challenging for some hydro units to forecast hydro that far in advance. Also for some entities, serving local loads takes priority over export to California. Also currently the FERC-approved ISO RA Import allocation process is one year at a time. Some LSEs prefer to sign multi-year contracts. In general, firming up capacity and energy going through number of Balancing Authority Areas may result in additional cost compared to internal California resources.

7.8 Summary of RA Analysis

Comparison of historical data for available capacity on COI and PDCI for RA contract, and the RA showings on these branch groups indicates that except for summer months, the RA showings are less than available MIC. While RA showings are low for non-summer months, the actual flow on COI and PDCI is quite high.

The historical flows on COI and PDCI that are used in the MIC determination makes available almost the total ISO share of the COI path rating for RA; however as indicated the RA procured

on the interties are lower than the available capacity while energy is flowing on the interties based upon market operations. This might be due challenges for some hydro units to forecast hydro in advance per the resource adequacy requirements for year ahead and monthly resource adequacy procurement.

The future generation development scenarios in the Pacific Northwest system will potentially impact the amount of available capacity and energy, increasing or decreasing, which can be exported to California in the longer term. This is due to the potential early retirement of coal units, load growth or a shift to more renewable integration in the Pacific Northwest. To ensure availability of Pacific Northwest resources to supply load in California in the long term, some market or policy initiatives and regulations may be required. Details of such market structures or policies were beyond the scope of this study. Market and policy initiatives such as the ISO's resource adequacy enhancement stakeholder initiative or the CPUC's integrated resource plan and resource adequacy proceedings may address some of the uncertainties of the Pacific Northwest resources to supply load in California in the long term.

8 Summary and Conclusions

This section provides a high level summary for the studies:

Increase the Capacity of AC and DC Interties

The study demonstrated that the north to south COI limit will remain 4,800 MW unless the outage of two adjacent 500 kV lines is treated as conditionally credible. In that case and following an update to the WECC path rating process that recognizes the limiting contingency to be conditionally credible, the COI north to south limit could increase to 5,100 MW. BPA intends to manage the incremental 300 MW as non-firm transmission. The allocation process for addressing the additional capacity as well as an implementation procedure will require coordination among the NWACI owners and CAISO.

PDCI flow is operationally limited to 1000 MW in the south-north direction by LADWP. The results of this study showed that there is potential to increase the south to north limit of PDCI to 1,500 MW under favorable conditions.

Both of the above increases would reduce the amount of congestion observed in the studies, as set out below.

Production simulation was done for three PNW water scenarios; low, medium and high water condition with 100 TWh, 148 TWh, and 172 TWh of electric power generated in the year, respectively. Study results showed that in the north to south direction the number of hours with COI congestion are 49, 349, and 1597 hours for low, medium and high scenarios. The medium hydro year was simulated with a 5,100 MW COI limit and the congested hours decreased from 349 hours to 265 hours. In the north to south direction, no congestion was observed on PDCI.

In the south to north direction, no congestion was observed on COI in any of the hydro conditions. However Path 26 was congested for more than 1,100 hours. PDCI modelled at its WECC path rating didn't show any congestion but a simulation with 1,000 MW south-north PDCI limit indicated 67 hours of congestion under medium hydro conditions.

Increase Dynamic Transfer Capability (DTC)

In 2018, BPA completed its DTC study and increased the DTC limits on the NWACI from 400 MW to 600 MW. In addition, BPA has removed the DTC Voltage Stability Limit (freezing/crimping) after obtaining the WECC Remedial Action Scheme Reliability Subcommittee's approval on the BPA's Synchronphasor Remedial Action Scheme as a Wide Area Protection. An increase in DTC on the NWACI above the 600 MW was not part of the scope for the current 2018-2019 TPP informational study. Thus, a separate DTC study would be needed in the future in order to establish what would be required for an increase to the DTC limit beyond the current limit of 600 MW.

Implementing sub-hourly scheduling on PDCI

Implementing 5-minute or even 15-minute scheduling capability on PDCI would facilitate further utilization of PNW hydro to supply California load especially during morning and evening ramps. To facilitate sub-hourly scheduling on PDCI, it is required to automate PDCI RAS as well as the AGC and EMS systems. A detailed system impact assessment on both BPA and LADWP systems is planned to be performed through a joint study. BPA, in coordination with the LADWP and the

other owners of the southern portion of the PDCI, anticipates that the project schedule from the scoping to the implementation phase will take approximately two to three years..

Assigning Resource Adequacy (RA) Value to firm zero-carbon imports

Except for summer months, the actual RA showings on COI and PDCI are less than available capacity while the actual real time flows are closer to the available capacity. This may imply that the surplus energy in PNW will flow to California even without an RA contract. While this might have been historically the case, under the existing market framework there would be uncertainties on the amount and profile of surplus generation in the PNW for export to California. The IRP, the ISO's RA enhancement initiative, CPUC's RA proceedings and other policy initiatives could take into account the long-term uncertainties on PNW resources to supply load in California.

8.1 Next Steps

To ensure availability of Pacific Northwest resources to supply load in California in the long term, some market or policy initiatives and regulations may be required. Details of such market structures, policies or regulations were beyond the scope of this study. The ISO has initiated a resource adequacy enhancements stakeholder initiative⁶ that will include an assessment of the rules for import resource adequacy and a review of the maximum import capability. In addition, the CPUC has ongoing resource adequacy⁷ and integrated resource plan⁸ proceedings. Stakeholders are encouraged to participate in these initiatives and proceedings.

The ISO will continue to monitor and participate in the WECC path rating process review. If the WECC path rating process is updated to recognize the concept of using the conditionally credible contingency of the adjacent 500 kV lines in the same right-of-way on separate towers, the ISO work with the owners of the COI facilities to initiate a WECC path rating process to increase the rating of COI to 5,100 MW. The ISO will also continue to monitor the progress of LADWP on the identified further study work of PDCI and BPA on the dynamic transfer capability and implementing sub-hourly scheduling on PDCI.

⁶ <http://www.caiso.com/informed/Pages/StakeholderProcesses/ResourceAdequacyEnhancements.aspx>

⁷ <http://www.cpuc.ca.gov/RA/>

⁸ <http://www.cpuc.ca.gov/irp/>

Attachment 1: BPA DTC Roadmap

DTC Roadmap

May 22, 2018

The objective of this paper is to discuss factors that limit Dynamic Transfer Capability (DTC) today and a portfolio of technical and potential policy solutions that BPA is working on to address them.

I. DTC LIMITATIONS

Expansion of Western Energy Imbalance Margin (EIM) connects multiple Balancing Authorities (BAs) across the Western Interconnection. EIM flows between Northwest and California can impact California – Oregon Intertie:

- a. **Excessive voltage fluctuations and reactive switching.** Frequent variations in active power flows can cause excessive variations in customer voltages (similar to customer voltage issues due to wind generation variability that BPA observed in 2007) or switching of voltage control devices such as shunt reactors, capacitors and tap changers. At the present DTC limits, the largest voltage variations are at the loads along COI lines (Central and Southern Oregon and Northern California). With higher DTC transfers on COI, other load areas could experience excessive voltage variations – e.g. Portland Metro, Central Washington. “Customer voltage variations” limitation applies over the full range of COI transfers, and more restrictive under high power transfers. Presently BPA DTC is 600 MW. Voltage variability is the limiting DTC factor about 80% of time today.
- b. **Voltage stability.** A fast ramp up of the COI power may result in a sub-optimal system state such that it may become voltage unstable for a critical contingency. This limitation applies to dynamic transfers when the flows are within 400 MW of the COI voltage stability limit. Voltage stability study was done by BPA Planning with all lines in service and COI SOL voltage stability limit of 4,800 MW. Outage studies did not produce consistent results, and therefore the voltage stability limitation is kept in place for outage conditions when SOL is less than 4,800 MW. Voltage stability is the limiting DTC factor about 20% of time, mainly under outage conditions. Starting recently, BPA disables the voltage stability limit when COI TTC is low.
- c. **RAS Arming.** A system can end up in an insecure state if dispatchers are unable to keep with manual RAS arming, as the RAS arming requirements change rapidly with changing system conditions. RAS arming requirements are very steep between 2,500 and 3,600 MW of COI flow. In addition, if a generator that is armed for RAS changes its power output because of EIM dispatch, the adjustments to over-all arming amount and its allocation among COI RAS participants are required for the system reliability.

Figure below illustrates the three DTC limitations, when they come into play, and their severity (based on color intensity):

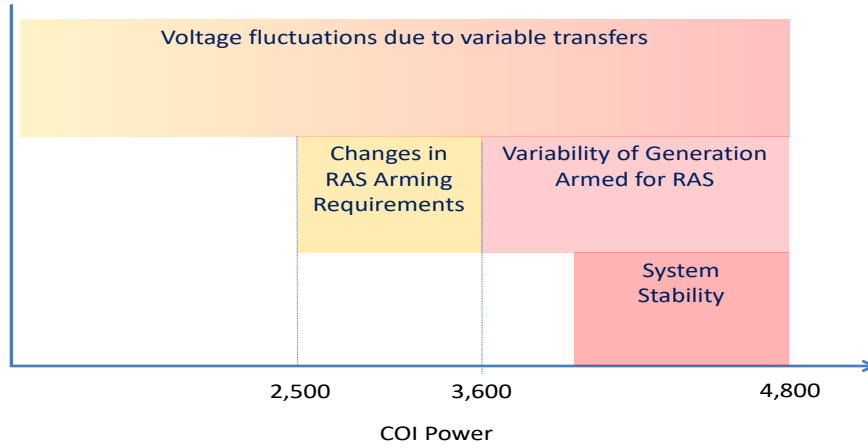

II. POTENTIAL SOLUTIONS TO INCREASE DTC

Sufficient studies have been done by consultants and BPA planning to demonstrate that COI DTC can be increased from 400 to 600 MW (+/-300 MW). The studies show that COI limitations are more restrictive than any internal flow-gate limitations. BPATO is taking steps to implement the DTC increase.

Here are potential solutions to increase DTC amount and usability by addressing each of the limitations identified earlier. Figure below provides overview of the efforts to address DTC limitations (and their relative timeline):

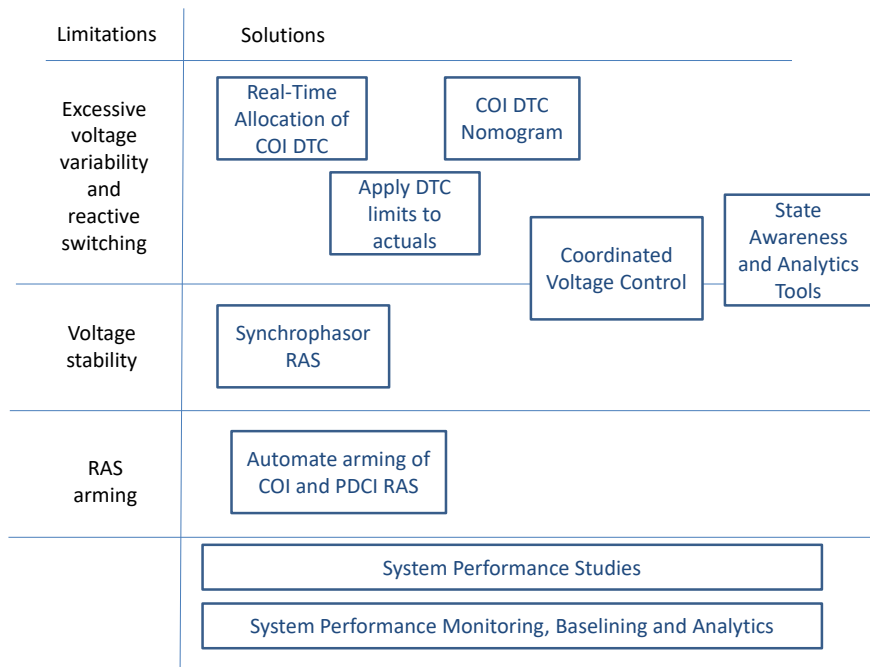

Voltage stability limitation

1. **Synchrophasor RAS** will remove voltage stability limit, which has been a pain point for some of the transmission users. Presently, BPA stops DTC dispatches when total COI flows are within 400 MW of COI Max TTC because of voltage instability concerns (a fast 400 MW power ramp was shown to put the system in a sub-optimal voltage and reactive reserve state where a critical contingency can result in voltage instability). Synchrophasor RAS will identify voltage stability risk using wide-area measurements and enable fast switching of shunt capacitors and reactors to improve voltage stability. Synchrophasor RAS was implemented in 2015, approved by WECC RAS RS as a safety net, operated in monitoring mode for several years, and went live in spring 2017. The RAS is fully redundant, and in addition uses diverse measurements to greatly minimize the risk of RAS unavailability. BPA's current plan is to seek approval of SP RAS as Wide-Area Protection Scheme. Once the RAS is approved, BPA will remove voltage stability limitation.

Customer Voltage Variability Limitation

2. **Employ Real-time Allocation of DTC.** Currently, DTC on COI is allocated in the day-ahead time frame. This results in inefficient use of the capabilities of the system, as a user of DTC may be blocked by their allocation limit even when the system is not near the total DTC limit. BPA is exploring applying the DTC limit in real-time on the net of all movement, instead of allocating ahead of time to reduce this inefficiency and allow significantly more dynamic usage within the same stated limits.
3. **Apply DTC Limit to Actuals (instead of schedules).** TOOC staff performed analysis of DTC usage which clearly indicates that DTC schedules do not translate one-to-one to actual five-minute flow variations on COI. Because schedules represent the commercial, not physical, flow expected, the actual change in flow is generally less than the magnitude of the corresponding schedule change. By relating the schedule change to the actual change in flow on COI using the PTDF of the source-sink pair, the actual impact of the dynamic movement can be captured. As with the previous considered change, BPA is considering having the limit implemented by the operator of Western EIM (i.e. California ISO), as their model should easily incorporate physical impacts.
4. **Use DTC Nomogram Instead of a Fixed Limit.** Voltage variability increases at higher COI flow following a classic Power-Voltage (PV) curve.

Figure below shows Power-Voltage trajectories of fast power ramps at various COI levels. It is very demonstrative that ramps become much steeper at higher COI flows.

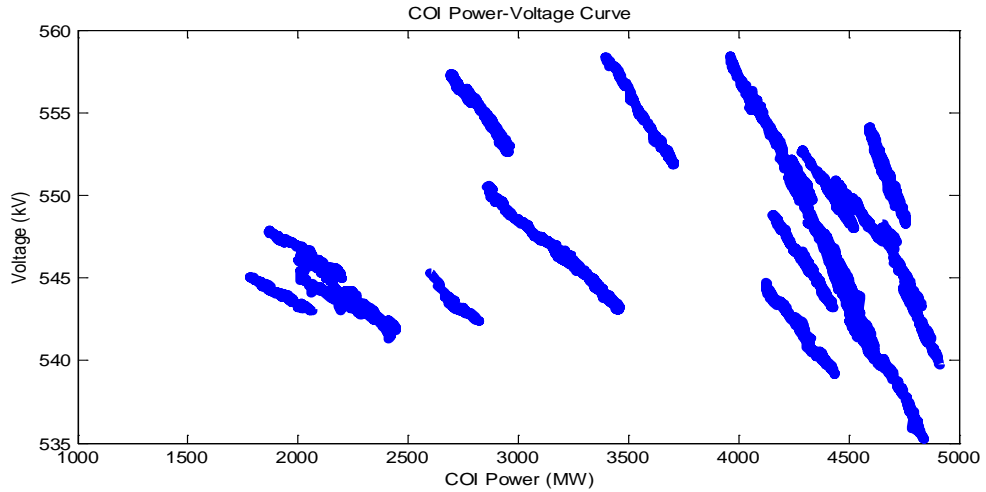

Intertie voltage vs COI flows during fast power ramps – historic data

Today, we apply a single conservative limit corresponding to the high COI flows. A nomogram would be more appropriate to take advantage of greater DTC at lower COI levels, as shown below. Nomogram implementation requires item #2 Real-Time Allocation of DTC as a prerequisite.

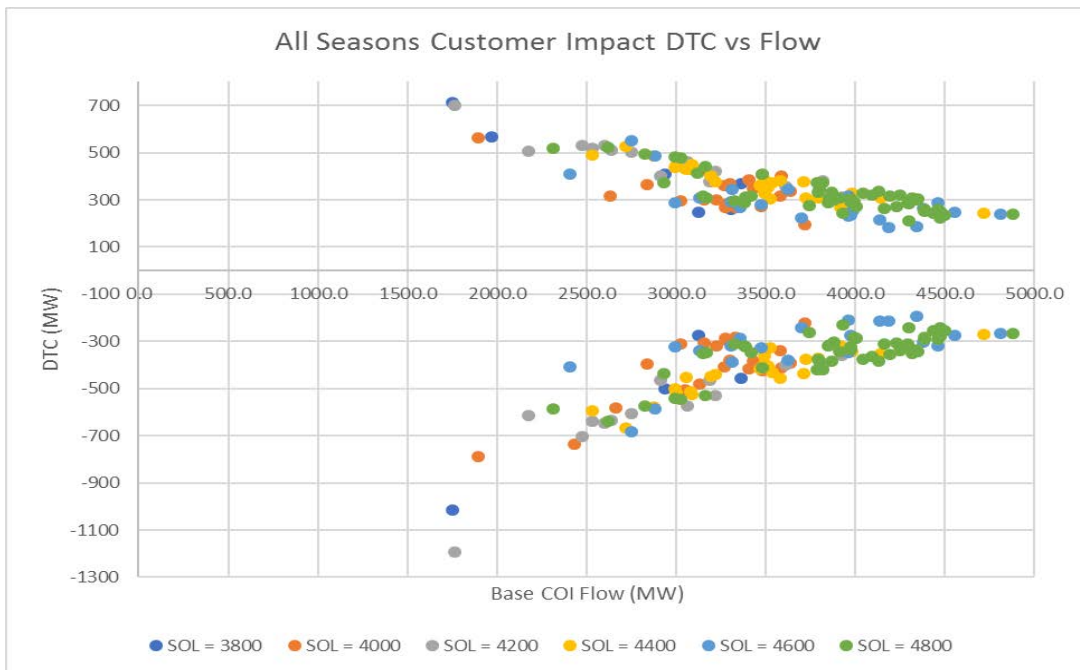

Nomogram of available COI DTC vs COI flow – studies

- 5. Real-Time Voltage Assessment Tools.** Real-time voltage assessment tools can be used in principle to determine the dynamic transfer impact on customer voltage variability and voltage stability. There is on-going research in this area. The weakness of this approach is dependence on a state estimator model which is not ready for robust real-time voltage stability assessment. Also, based on a large number of sensitivity studies we performed, the benefits of using real-time tools are likely to be minimum compared to the nomogram.
- 6. Coordinated Voltage Controls.** Further increase in DTC can be achieved by deploying Coordinated Voltage Controls (CVC). BPA currently uses Automated Voltage Controls (AVC) and SCADA alarms for main grid voltage management. AVC control bands are very wide and well outside the customer voltage tolerance bands. BPA implemented special voltage controls, called Automatic Reactive Controls (ARC) at wind generation hubs to coordinate switching of BPA shunt capacitors with voltage controls and reactive resources of wind farm. Proposed CVC will be similar in principle to ARC. Control feasibility assessment is currently performed under BPA TIP 370. CVC will address both customer voltage variability and voltage stability limitations.

CVC will apply to the NW side of the Pacific AC Intertie and the BPA network. We recently learned that transmission system south of the border does not have automated voltage controls on their side of the intertie, and therefore they will have the similar voltage variability limitations and will need similar controls to achieve full utilization of COI DTC. Coordination with PG&E and TANC are required.

PDCI DTC:

PDCI already has local controller that keep reactive power exchange between Celilo and the network within a pre-specified range. LADWP has a similar controller at Sylmar side. BPA has concerns about increase in frequency of cap switchings on PDCI, and potential OEM impacts. Coordination with LADWP is required.

If BPA implements simultaneous DTC on COI and PDCI, additional studies are required to determine the network impact, and the CVC will be most likely required to maintain network voltage profile and stability.

Outages of Keeler and Maple Valley SVCs have shown significant voltage variations in Portland and Seattle metro areas due to dynamic transfers. CVC can be used to mitigate DTC reduction when the SVCs are unavailable during maintenance outages.

- 7. Control State Awareness and Analytics.** First ARC at Jones Canyon had excessive switching of BPA shunt capacitors because of voltage measurement errors between BPA and wind plants. BPA Planning performed additional performance studies and changed controller settings to reduce the number of operations by a factor of three. If we are to implement CVC, we will need engineer state awareness tools to detect ramps and controller switching, as well as simulation tools to reproduce controller behavior.

RAS Arming

- 8. RAS arming Automation.** RAS arming is not an issue at this time, but may come to the forefront if we were to increase DTC beyond 600 MW. BPA is in process of automating arming of COI and PDCI RAS. The automation will remove this limitation.

Technical Support

- 9. System Performance Studies.** On-going study support is required. Planning studies are required to identify constraints on dynamic transfers and to set initial DTC limits. As BPA gains more experience with DTC, the validation studies of DTC events will be done to verify assumptions used in DTC studies, and further improve the study limits.
- 10. System Performance Monitoring, Baseline and Analytics.** BPA is developing analytics for performance monitoring, baselining and analysis. The analytics will baseline voltage variations, reactive switching and reactive reserves due to dynamic transfers.

III. Coordination Among Intertie Path Operators and Owners

It is important to note that coordination among the path operators and owners of the interties is essential. Studies addressing DTC capabilities require coordination with BPA and its NWACI partner asset owners, BPA's capacity owners, as well as the COI and PDCI path operators and owners.