

July 16, 2020

The Honorable Kimberly D. Bose
Secretary
Federal Energy Regulatory Commission
888 First Street, NE
Washington, DC 20426

**Re: California Independent System Operator Corporation
Docket No. ER20- ____-000**

**Tariff Amendment to Implement Demand Response
Enhancements**

Request for Waiver of Notice Period

Dear Secretary Bose:

The California Independent System Operator Corporation (“CAISO”) submits this tariff amendment to enhance demand response participation in the CAISO markets.¹ These enhancements result from the third phase of the CAISO’s energy storage and distributed energy resource stakeholder initiative (“ESDER”).² The CAISO proposes two sets of enhancements:

- A. Allowing electric vehicle charging stations to have a separate load curtailment measure when providing demand response with onsite load; and
- B. Creating a demand response participation model that facilitates “load shifting” capabilities and accounts for when behind-the-meter energy storage charges and discharges at optimal times.³

¹ The CAISO submits this filing pursuant to section 205 of the Federal Power Act (“FPA”), 16 U.S.C. § 824d. Capitalized terms not otherwise defined herein have the meanings set forth in the CAISO tariff, and references to specific sections, articles, and appendices are references to sections, articles, and appendices in the current CAISO tariff and as revised or proposed in this filing, unless otherwise indicated.

² The instant enhancements’ software took longer to develop than the two enhancements from ESDER 3 the Commission approved last year, hence their submission in separate filings. *California Independent System Operator Corp.*, Letter Order Accepting Tariff Revisions, ER19-2733-000 (Nov. 6, 2019).

³ The CAISO’s approach to energy storage is technology neutral. Although lithium-ion batteries are the most common type of energy storage, the CAISO has designed its non-generator resource model and demand response models to accommodate other storage technologies, including sodium-

The first set of proposed enhancements is designed for loads with onsite electric vehicle supply equipment (“EVSE”), the industry term for charging stations and their supporting infrastructure. The onsite load—typically a building—will have a different load profile than its EVSE. Under current rules, when both loads participate in demand response, they must share a single performance measurement under a single methodology. The CAISO proposes to revise its tariff to allow the demand response provider to sub-meter the EVSE separately so it can have its own demand response performance evaluation and use a more appropriate performance methodology than its host load.

The second set of enhancements establishes a new demand response model that will incentivize behind-the-meter energy storage resources to consume energy during oversupply conditions and return that energy to the system during times of need. This load-shift product will enable demand response providers with behind-the-meter energy storage to bid and be dispatched for both load consumption (charging, negative generation) and load curtailment (discharging, generation). The load-shift product also can account for when the onsite load curtails its demand independent of the energy storage.

The CAISO notes that each set of revisions is separate and not dependent on the other, from both a substantive and an implementation perspective. The CAISO has filed them together because they were part of the same stakeholder process, they represent demand response enhancements, and a single filing promotes administrative efficiency. The CAISO respectfully requests the Commission issue and order approving the proposed revisions by September 15, 2020, with an effective date of October 1, 2020.

II. Background

In 2015 the CAISO began the first phase of its ESDER initiative, which sought to solve the CAISO-related issues identified in the California Energy Storage Roadmap and solicit additional suggestions from stakeholders on issues regarding energy storage, demand response, distributed resources, and behind-the-meter resources. This first phase focused on the non-generator resource model (used by storage resources), demand response enhancements, and clarifying the rules for “multiple-use applications,” namely resources capable of providing service both to end-use customers and to the wholesale electricity markets.⁴ The Commission approved the CAISO’s initial ESDER reforms in 2016.⁵

sulfur batteries, flywheels, compressed air, etc. Generally, however, pumped storage participates solely under the Pumped Storage Hydro Unit model.

⁴ The examination of multiple-use application rules did not result in tariff revisions.

⁵ *California Independent System Operator Corp.*, 156 FERC ¶ 61,110 (2016).

In 2016 the CAISO began phase two of its ESDER initiative. Phase two focused on (1) providing three new demand response evaluation methodologies; (2) clarifying the metering, settlement, and netting rules regarding station power for energy storage resources; and (3) revising the fuel price calculation in the CAISO's net benefits test to expand the natural gas indices inputs. The Commission approved these reforms in 2018.⁶

The CAISO began phase three of its ESDER initiative in 2017. Phase three focused on the instant enhancements and the demand response enhancements the Commission approved last year.⁷

The CAISO currently is conducting phase four of the ESDER initiative.⁸ Phase four focuses on (1) biddable state-of-charge targets, (2) market power mitigation for energy storage, (3) demand response enhancements, and (4) streamlining participation agreements for energy storage.⁹ In addition, the CAISO has worked closely with the Commission on national energy storage and distributed energy resource reforms. The CAISO has participated in numerous technical conferences and submitted many comments on Commission storage proceedings, including Order No. 841.

III. Proposed Tariff Revisions

A. Separating EVSE Performance

1. Background

Load, storage, and generation resources frequently participate in the CAISO markets under the CAISO's demand response model. These resources can be transmission-connected, distribution-connected, or behind a retail meter. These resources participate in the CAISO markets by providing load curtailment as one of two resource types: proxy demand resources or reliability demand response resources.¹⁰ Proxy demand resources are economically dispatched, and reliability demand response resources are dispatched only when the CAISO's system is near or in a system

⁶ See *California Independent System Operator Corp.*, Letter Order, ER18-2242-000 (Oct. 24, 2018).

⁷ *California Independent System Operator Corp.*, Letter Order, ER19-2733-000 (Nov. 6, 2019).

⁸ *Id.*

⁹ See CAISO Draft Final Proposal on ESDER Phase 3, available at <http://www.aiso.com/Documents/DraftFinalProposal-EnergyStorage-DistributedEnergyResourcesPhase3.pdf>.

¹⁰ "Demand response resources" is the generic term for both types.

emergency.¹¹ Both types of demand response resources typically consist of aggregated retail customer service accounts, each with their own retail customer meters. Aggregating these accounts enables demand response providers to make larger, more meaningful responses to CAISO price signals.

The CAISO pays demand response resources when they curtail their demand pursuant to CAISO dispatch. This requires determining what the demand response resource's demand would have been absent CAISO dispatch. Today the CAISO has five methodologies to determine a demand response resource's expected performance, generally called the resource's "baseline." Resources with load have a Customer Load Baseline,¹² and resources with storage or generation may have a Generator Output Baseline, or both.¹³ The CAISO settles the demand response performance by subtracting its baseline from its actual performance responding to dispatch.¹⁴ The five distinct methodologies for calculating demand response baselines are: (1) the ten-in-ten methodology, (2) the metering generator output methodology, (3) the control group methodology, (4) the five-in-ten methodology, and (5) the weather matching methodology. Each methodology is tailored for different arrangements, technologies, and load profiles. Demand response providers elect methodologies based upon which methodology best captures their performance.

Although demand response resources successfully participate in the CAISO markets, the CAISO and its stakeholders always seek to improve their ability to effectively participate as supply side resources. Demand response resources now include a mix of diverse consumers including industrial plants with large loads, residential air conditioners and appliances, commercial air conditioners, electric vehicle charging stations, mills, refineries, farms, labs, and schools. Load-serving entities in the West even offer specialized demand response consulting for wineries.¹⁵ A large and growing share of demand response resources have their own onsite load, generating capacity, and batteries.

One trend that has become prolific is providing electric vehicle charging at large load centers like grocery stores, movie theaters, and offices. These charging stations range from simple low-voltage plugs for a single electric vehicle to many high-voltage facilities with separate onsite generation and storage capable of

¹¹ See *California Independent System Operator Corp.*, 144 FERC ¶ 61,047 at PP 8 *et seq.* (2013) (explaining a reliability demand response resource); see also Section 4.13.5 of the CAISO tariff (outlining the characteristics of proxy demand resources and reliability demand response resources).

¹² See Section 4.13.4.1 *et seq.*

¹³ Section 4.13.4.2 of the CAISO tariff.

¹⁴ See Section 11.6 of the CAISO tariff.

¹⁵ See https://www.pge.com/includes/docs/pdfs/mybusiness/energysavingsrebates/incentivesbyindustry/agriculture/06_wineres_fs_v4_final.pdf.

charging numerous electric vehicles simultaneously and rapidly. Frequently these charging stations operate under the same retail meter and account as their host facility. Under the CAISO tariff, such arrangements must participate as a single demand response resource under a single performance methodology.¹⁶ This restriction may be problematic for some customers because the EVSE and the onsite host load may have very different load profiles and responses to CAISO dispatch. For example, an office building may have high demand during work hours, but EVSE demand generally peaks immediately after morning commutes. By failing to capture the unique aspects of the EVSE, the CAISO may be sending the wrong price signals to EVSE owners, thereby failing to incentivize them to participate in demand response programs that can curtail load during peak conditions and help the CAISO maintain reliability.

2. Proposed Tariff Revisions

The CAISO proposes to allow proxy demand resources to measure EVSE performance separately, even if the EVSE shares a retail service account with other onsite load.¹⁷ EVSEs also may use a different performance methodology than their onsite load.¹⁸ These are not requirements; proxy demand resources may continue to include EVSE performance with the rest of their load. The CAISO proposes to define EVSE as “Load, Energy, and storage resources consisting of charging stations, charging docks, or other facilities used to interconnect and supply Energy to electric vehicles.”¹⁹

Where proxy demand resources elect to measure EVSE performance separately, they must sub-meter the EVSE to avoid commingling the EVSE load and the onsite load’s performance.²⁰ This requirement is similar to the CAISO’s

¹⁶ As part of the CAISO registration process, demand response providers must list all retail service accounts participating in each demand response resource. This enables the CAISO to verify that multiple demand response resources are not sharing the same service accounts. The CAISO also verifies all information with the resource’s load-serving entity and utility distribution company. See Section 4.13.2 of the CAISO tariff.

¹⁷ Proposed Sections 4.13.4 and 4.13.4.6 of the CAISO tariff. Reliability demand response resources must measure any EVSE load with its onsite load. If EVSE load were included in a reliability demand response resource, it would be expected to perform the same as its onsite load in a system emergency. Additionally, the vast majority of EVSE participation will come through proxy demand resources.

¹⁸ *Id.*

¹⁹ Proposed “Electric Vehicle Supply Equipment,” Appendix A to the CAISO tariff. Proposed Section 4.13.4.6 also clarifies that EVSE load includes the load of charging electric vehicles, obviously their largest source of demand. This section also clarifies that EVSEs may be aggregated together just like other loads in a proxy demand resource.

²⁰ Proposed Section 4.13.4.6 of the CAISO tariff.

metering requirement for the metering generator output methodology, which captures the load curtailment from behind-the-meter generation separate from common load curtailment.²¹ The CAISO proposes that EVSEs attached to residential loads may use the CAISO's ten-in-ten or the five-in-ten methodology, and non-residential EVSEs may use the ten-in-ten methodology.²² This follows the rules for other proxy demand resources, which were approved as just and reasonable based on CAISO studies evaluating performance methodology efficiency for different customer classes.²³ Onsite load may continue to use any methodology for which it is eligible under the current tariff.²⁴

Where proxy demand resources elect to separate their EVSE performance from the onsite host load, they will continue to operate under a single resource ID as a single proxy demand resource, but the EVSE and the onsite load will have separate customer load baselines and separate demand response energy measurements.²⁵ The EVSE and the onsite load will bid and meet CAISO schedules together as a single resources, but the CAISO will settle them separately based on each load's respective baseline. Nothing requires the demand response provider to include onsite load in the proxy demand resource, however. A proxy demand resource can consist entirely of one or more EVSE with no onsite load.²⁶ In any case, all existing proxy demand response requirements still apply to these resources.

The Commission should approve these proposed revisions as just and reasonable. They provide transparency and more accurate price signals for EVSE and onsite load participating in demand response programs. The CAISO has substantial experience in developing demand response methodologies, and the

²¹ Section 4.13.4.2 of the CAISO tariff.

²² Proposed Section 4.13.4.6 of the CAISO tariff. Scheduling Coordinators will not apply an adjustment factor to EVSE baselines. Unlike retail consumer demand response programs, especially air conditioner cycling programs, there is no indication that EVSEs are weather dependent or require multiple hours to begin to respond to dispatch or to return to typical use after dispatch. As such, the CAISO has included a provision instructing scheduling coordinators not to apply an adjustment factor. *Id.*

²³ See *California Independent System Operator Corp.*, Letter Order, ER18-2242-000 (Oct. 24, 2018). There is no indication that EVSE load profiles would be substantially weather dependent, making the weather matching methodology inappropriate. Similarly, the CAISO does not propose to extend the control group methodology to EVSE until the CAISO can acquire sufficient data to ensure it would accurately capture EVSE baselines. Moreover, stakeholders have not expressed any need for the control group methodology at this time, likely because it requires a large group of non-participants for the control group itself.

²⁴ Proposed Section 4.13.4.6 of the CAISO tariff.

²⁵ *Id.*

²⁶ *Id.*

proposal does not present any undue gaming opportunities and is not unduly discriminatory. Charging stations are growing at a rapid rate, and the CAISO's proposed revisions keep the CAISO on pace with this technology. Stakeholders broadly supported the CAISO's proposed revisions.

B. Load-Shift Product

1. Background

The duck curve arguably is the CAISO's greatest current challenge.²⁷ High solar penetration results in a low net load curve in the early afternoon, followed by a steep evening ramp caused by the sunset and peak demand. Managing the evening ramp is a complex process requiring the CAISO's optimization and dispatchers to commit and ramp-up many large gas-fired units simultaneously. The CAISO has implemented many products and myriad optimization enhancements to ensure it can maintain reliability against the duck curve. But the duck curve presents economic issues as well. Especially in shoulder months with low temperatures, the demand nadir frequently results in negative energy prices and curtailing large amounts of free or low-cost energy.²⁸ April 2020 resulted in a new monthly high of curtailed energy at 318,444 MWh.²⁹

Demand response and storage both can play a key role in mitigating the duck curve. By charging off-peak and discharging on-peak, storage can raise the demand nadir, avoid curtailment, and provide energy to meet the demand peak. Similarly, demand response can lower the demand peak. Together storage and demand response help erode the steepness of the evening ramp, relieving pressure on gas-fired units and CAISO operators while helping to stabilize prices.

Storage is being deployed across the CAISO at a high rate and at every level of interconnection and capacity. Many consumers are adding storage devices to homes and workplaces behind their retail customer meters. These small storage devices' size, cost, and retail revenue opportunities make them impractical for participating wholly in the CAISO markets; but, they can participate more easily in demand response programs. The CAISO's metering generator output methodology, for example, allows demand response providers to bifurcate their

²⁷ See, CAISO, "Duck Curve," https://www.aiso.com/Documents/FlexibleResourcesHelpRenewables_FastFacts.pdf; Carlos Waters, "This 'Duck Curve' is Solar Energy's Greatest Challenge," Vox Media (May 9, 2018), <https://www.vox.com/2018/5/9/17336330/duck-curve-solar-energy-supply-demand-problem-aiso-nrel>.

²⁸ CAISO, "Managing Oversupply," <http://www.aiso.com/informed/Pages/ManagingOversupply.aspx>.

²⁹ *Id.*

pure load curtailment³⁰ from load curtailment from behind-the-meter generation.³¹ But the CAISO's metering generator output methodology was not designed to capture the unique value of charging a battery precisely during oversupply conditions. The CAISO's current methodologies only capture the value of reducing demand compared to typical use. They do not incentivize storage resources to *increase* demand during oversupply conditions that would help maintain reliability, avoid curtailment, and stabilize prices.

2. Proposed Revisions

The CAISO proposes to create a new "load-shift methodology" for proxy demand resources with behind-the-meter energy storage.³² Proxy demand resources using this methodology will have two separate Resource IDs: (1) a consumption Resource ID to account for the energy storage charging alone; and (2) a curtailment Resource ID to account for the energy storage discharging to increase onsite load curtailment.³³ The scheduling coordinator must submit energy supply bids below \$0/MWh for the consumption Resource ID, and above the market clearing price for the curtailment Resource ID.³⁴ Each Resource ID will have its own baseline and demand response energy measurement, and the CAISO's optimization will avoid sending conflicting dispatch signals to the resources.³⁵

Where existing methodologies only can incentivize economic load curtailment, the CAISO's proposed bifurcation into two distinct Resource IDs with different functions will incentivize and reward both curtailment and charging at the right times. Requiring the consumption ID to bid below \$0/MWh ensures it can only be dispatched to provide demand response energy during oversupply conditions.³⁶ The curtailment Resource ID, on the other hand, follows similar rules applicable to other proxy demand resources.

Each Resource ID will have its own baseline to establish typical use. The baselines will be calculated using methodologies nearly identical to the CAISO's

³⁰ *I.e.*, turning devices off when they would normally be on.

³¹ *I.e.*, masking retail demand by providing energy onsite behind the retail meter.

³² Charging batteries during oversupply conditions is not the purpose of reliability demand response resources, hence their exclusion.

³³ Proposed Sections 4.13.4.7 and 11.6.7 of the CAISO tariff.

³⁴ Proposed Section 30.6.1.2 of the CAISO tariff.

³⁵ Proposed Section 4.13.4.7 of the CAISO tariff. Batteries cannot charge and discharge at the same time, hence the need to avoid conflicting dispatch signals.

³⁶ To be sure, the storage resource can still charge whenever it elects, just like any demand response resource can be a source of demand at any time. Principally these are retail loads. The point is they are only settled for demand response energy when dispatched to provide it.

existing metering generator output methodology, which is similar to the ten-in-ten methodology established by Order No. 745.³⁷ The difference is that the consumption Resource ID will only use meter data at or below 0 MWh (when the battery is charging), and the curtailment Resource ID will only use meter data at or above 0 MWh (when the battery is discharging).³⁸ This enables the CAISO to measure the battery's performance against both functions. In other words, if the CAISO treated the entire proxy demand resource as one Resource ID instead of two, the resource's customer load baseline would effectively net its charging and discharging, thereby failing to fully capture the value of each distinct function.³⁹

The CAISO's metering generator output methodology already reflects the distinction between a Customer Load Baseline (for typical demand response and the consumption Resource ID) and a Generator Output Baseline (for behind-the-meter supply and the curtailment Resource ID). Like all demand response resources, the CAISO will settle each Resource ID based on the difference between each baseline and the resources' actual response to dispatch.⁴⁰

Similar to the EVSE methodology proposed above and the existing metering generator output methodology, proxy demand resources using the load-shift methodology must sub-meter the storage device independently of the onsite load or other on-site generation sources.⁴¹ The Draft Final Proposal, included here as Attachment C, provides examples of possible arrangements. Demand response providers may elect to include onsite load curtailment independent of the energy

³⁷ Proposed Section 4.13.4.7 of the CAISO tariff. The proposed baseline calculation has been well established since Order No. 745. Scheduling coordinators evaluate meter data from the previous 45 days to find a minimum number of similar days and intervals where the resource did not declare an outage or respond to dispatch. The targets are 10 similar intervals on business days, with a minimum of five; and five similar intervals on non-business days, with a minimum of four. The scheduling coordinator then averages the collected meter data over the target number of typical days to establish the baseline. Like EVSEs, there is no indication that battery use is weather dependent or requires multiple hours to begin to respond to dispatch or to return to typical use after dispatch (like air conditioner cycling programs). As such, the CAISO has not included an adjustment factor in the load-shift baseline methodology.

³⁸ Proposed Sections 4.13.4.7 and 11.6.7 of the CAISO tariff.

³⁹ The load-shift methodology is an election. Proxy demand resources with behind-the-meter storage still may elect to use other methodologies for which they are eligible.

⁴⁰ Proposed Section 11.6.7 of the CAISO tariff. Consistent with Order No. 745, the CAISO excludes any energy exports, *i.e.*, energy that exceeds onsite demand.

⁴¹ Proposed Section 4.13.4.7 of the CAISO tariff. Consistent with the net benefits test established by Order No. 745, all proxy demand resources' energy bids must be above the market clearing price. See Section 30.6.3 of the CAISO tariff; *California Independent System Operator Corp.*, Transmittal Letter, ER19-2733-000 (Sep. 3, 2019) (discussing the history of the net benefits test and the market clearing price).

storage with the proxy demand resource.⁴² In such cases, the scheduling coordinator will calculate a separate Customer Load Baseline for the onsite load, excluding the energy or demand from the energy storage. Scheduling coordinators may calculate the onsite load baseline using the ten-in-ten, five-in-ten, or weather-matching methodology for residential resources; and using the ten-in-ten or weather-matching methodology for non-residential resources.⁴³ The scheduling coordinator will then add the demand response energy measurement of the onsite load to the curtailment Resource ID.⁴⁴

The CAISO proposes to include a new tariff provision describing the bidding rules for proxy demand resources using the load-shift methodology.⁴⁵ This section mostly reiterates Section 30.6.1,⁴⁶ which describes the general bidding rules for proxy demand resources, but specifies that scheduling coordinators for proxy demand resources using the load-shift methodology will submit separate Economic Bids for the curtailment Resource ID and the consumption Resource ID that comprise the Proxy Demand Resource.⁴⁷ This section also specifies the bidding floors for each Resource ID described above.⁴⁸ Scheduling coordinators also can indicate in the CAISO master file their election to bid and be scheduled in 5- or 15-minute intervals in the CAISO real-time markets.⁴⁹

Likewise, the CAISO proposes to include a new tariff provision describing the settlement provisions for proxy demand resources using the load-shift methodology.⁵⁰ This section mostly reiterates Section 11.6.1, which describes the

⁴² Proposed Sections 4.13.4.7 and 11.6.7 of the CAISO tariff. (Similar to the metering generator output methodology.)

⁴³ Proposed Section 4.13.4.7 of the CAISO tariff. The CAISO is not proposing to extend the control group methodology to loads paired with participating storage at this time until it can study its baseline accuracy for such resources.

⁴⁴ *Id.*

⁴⁵ Proposed Section 30.6.1.2 of the CAISO tariff.

⁴⁶ For example, like all proxy demand resources, proxy demand resources using the load-shift methodology must submit the actual underlying consumption or energy during all hourly intervals for the calendar days for which meter was collected to develop their baselines. This ensures the CAISO and its Department of Market Monitoring can monitor compliance. Additionally, the section clarifies that proxy demand resources will be settled only in intervals where their total expected energy is above zero. See Section 11.6.1.

⁴⁷ Proposed Section 30.6.1.2 of the CAISO tariff.

⁴⁸ *Id.*

⁴⁹ Proposed Section 4.13.3 of the CAISO tariff. Because storage resources can respond quickly, resources using this methodology cannot elect to participate in hourly blocks in real-time. If resources require the hourly block option, they always can change to a different methodology.

⁵⁰ Proposed Section 11.6.7 of the CAISO tariff.

general settlement rules for proxy demand resources, but specifies how each distinct Resource ID will be settled using its corresponding baseline. This provision also clarifies that proxy demand resources using the load-shift methodology are eligible for bid cost recovery, although certain costs like start-up, pumping, and transition costs are inapplicable.⁵¹

The CAISO also proposes to include a provision clarifying that the proxy demand resource's qualifying capacity excludes performance from the consumption Resource ID. Any resource adequacy capacity for demand reduction provided by the proxy demand resource is captured by the curtailment Resource ID.⁵²

The Commission should approve the CAISO's proposal as just and reasonable. Most provisions described above are similar, if not identical, to existing demand response rules in the CAISO tariff. As such, they ensure accuracy, prevent gaming, and encourage resources to participate in the wholesale markets. The new aspects of the CAISO's proposal capture the unique abilities of behind-the-meter energy storage, which can raise the belly of the duck, curb oversupply and negative pricing, and offer energy during peak demand. Without this load-shift methodology, these resources will have less incentive to participate in wholesale demand response programs, and the CAISO will be unable to capture their singular benefits. The CAISO's efforts to encourage behind-the-meter energy storage to participate in demand response Stakeholders broadly supported this proposal.

IV. Stakeholder Process

The stakeholder process that resulted in this filing included:

- Five papers produced by the CAISO;
- Nine stakeholder meetings and conference calls to discuss the CAISO papers and the draft tariff provisions; and
- Eight opportunities to submit written comments on the CAISO issue papers and the draft tariff provisions.⁵³

There was broad stakeholder support for the policies resulting in these proposed tariff revisions. They were presented to the CAISO Board of Governors

⁵¹ *Id.*

⁵² Proposed Section 40.8.1.13. Put another way, the consumption Resource ID only charges, thereby providing demand. Even if it charges during oversupply conditions, oversupply conditions are the opposite of the demand peak that requires resource adequacy capacity.

⁵³ All stakeholder materials are available on the CAISO website: http://www.caiso.com/informed/Pages/StakeholderProcesses/EnergyStorage_DistributedEnergyResources.aspx.

on August 28, 2018, where the Board voted unanimously to authorize this filing.

V. Effective Date and Request for Order

The CAISO respectfully requests that the Commission issue an order by September 15, 2020, approving the proposed revisions effective October 1, 2020. Approval within this timeline will provide the CAISO and its software developers with the requisite certainty to test and implement the enhanced software—under a Commission order—before the tariff revisions go into effect on October 1.

VI. Communications

Under Rule 203(b)(3) of the Commission's Rules of Practice and Procedure,⁵⁴ the CAISO requests that all correspondence, pleadings, and other communications regarding this filing should be directed to:

Roger E. Collanton
General Counsel
Sidney L. Mannheim
Assistant General Counsel
William H. Weaver
Senior Counsel
California Independent System
Operator Corporation
250 Outcropping Way
Folsom, CA 95630
Tel: (916) 351-4400
Fax: (916) 608-7222
E-mail: bweaver@caiso.com

VII. Service

The CAISO has served copies of this filing on the California Public Utilities Commission, the California Energy Commission, and all parties with scheduling coordinator agreements under the CAISO tariff. In addition, the CAISO has posted a copy of the filing on the CAISO website.

⁵⁴ 18 C.F.R. § 385.203(b)(3).

VIII. Contents of Filing

Besides this transmittal letter, this filing includes these attachments:

- | | |
|--------------|---|
| Attachment A | Clean CAISO tariff sheets incorporating this tariff amendment |
| Attachment B | Red-lined document showing the revisions in this tariff amendment |
| Attachment C | Draft final proposal |
| Attachment D | Board memorandum |

IX. Conclusion

The CAISO respectfully requests that the Commission accept these proposed tariff revisions with an effective date of October 1, 2020.

Respectfully submitted,

/s/ William H. Weaver

Roger E. Collanton
General Counsel
Sidney L. Mannheim
Assistant General Counsel
William H. Weaver
Senior Counsel

Counsel for the California Independent
System Operator Corporation

Attachment A – Clean Tariff

ESDER Phase 3B

California Independent System Operator Corporation

July 16, 2020

Appendix A

- Electric Vehicle Supply Equipment (EVSE)

Load, Energy, and storage resources consisting of charging stations, charging docks, or other facilities used to interconnect and supply Energy to electric vehicles.

* * * * *

Section 4

* * * * *

4.13.3 Identification of RDRRs and PDRs

Each Demand Response Provider shall provide data, as described in the Business Practice Manual, identifying each of its Reliability Demand Response Resources or Proxy Demand Resources and such information regarding the capacity and the operating characteristics of the Reliability Demand Response Resource or Proxy Demand Resource as may be reasonably requested from time to time by the CAISO. All information provided to the CAISO regarding the operational and technical constraints in the Master File shall be accurate and actually based on physical characteristics of the resources. Demand Response Providers for Proxy Demand Resources may elect to specify in the Master File how the Proxy Demand Resource will bid and be dispatched in the Real-Time Market: in (i) Hourly Blocks, (ii) fifteen (15) minute intervals, or (iii) five (5) minute intervals. Proxy Demand Resources using the load-shift methodology described in Section 4.13.4.7 may elect to bid and be dispatched in the Real-Time Market in fifteen (15) minute intervals or five (5) minute intervals. If Demand Response Providers do not submit an election in the Master File, the CAISO will set five (5) minute intervals as the default.

4.13.4 Performance Evaluation Methodologies for PDRs and RDRRs

The following methodologies may be utilized to calculate Customer Load Baselines and Demand

Response Energy Measurements for Proxy Demand Resources and Reliability Demand Response Resources. Proxy Demand Resources and Reliability Demand Response Resources consisting of residential End Users may elect to use the ten-in-ten methodology, metering generator output methodology, control group methodology, five-in-ten methodology, or weather matching methodology. Proxy Demand Resources and Reliability Demand Response Resources consisting of non-residential End Users may elect to use the ten-in-ten methodology, metering generator output methodology, control group methodology, or weather matching methodology. Proxy Demand Resources with behind-the-meter energy storage also may elect to use the load-shift methodology. If an EVSE elects to participate as a Proxy Demand Resource and use a different methodology than its co-located Load, it must adhere to Section 4.13.4.6. Proxy Demand Resources providing Ancillary Services must submit Meter Data for the intervals immediately preceding, during, and following the Trading Interval(s) in which the Proxy Demand Resources were awarded Ancillary Services. As specified in the Business Practice Manual, the CAISO will retain authority to calculate or correct Customer Load Baselines and Demand Response Energy Measurements for those resources that used the CAISO's Demand Response System, until all relevant metering, settlement, and correction windows have lapsed since the CAISO retired its ability to calculate on behalf of Scheduling Coordinators in the Demand Response System.

* * * * *

4.13.4.6 Electric Vehicle Supply Equipment (EVSE)

Proxy Demand Resources may include or consist entirely of EVSEs. Proxy Demand Resources may elect to use different methodologies to calculate the Customer Load Baselines and Demand Response Energy Measurements of (i) their EVSEs, including electric vehicle charging Load, and (ii) any other Load or behind-the-meter Generation participating as Proxy Demand Resources. Where a Proxy Demand Resource elects to do so, the EVSE Load must be metered separately from any other Load or Generation. Individual EVSEs may be aggregated into Proxy Demand Resources consistent with Section 4.13.2. Where the Load at the EVSE's Location also participates as a Proxy Demand Resource, the EVSE must participate in the same Proxy Demand Resource, but may elect to have a separately metered

Customer Load Baseline and Demand Response Energy Measurement consistent with this Section. To calculate EVSE Customer Load Baselines and Demand Response Energy Measurements under this section, non-residential EVSEs may use the ten-in-ten methodology, and residential EVSEs may use the ten-in-ten methodology and the five-in-ten methodology. Scheduling Coordinators for EVSEs participating under this section will not apply an adjustment factor pursuant to subsection (c) of either methodology. Non-EVSE Load also participating in the EVSE's Proxy Demand Resource may use any eligible methodology for its Customer Load Baseline and Demand Response Energy Measurement.

4.13.4.7 Load-Shift Methodology

Only Proxy Demand Resources using behind-the-meter energy storage may elect to use the load-shift methodology described in this Section. The energy storage must be metered separately from other Load or Generation. Proxy Demand Resources using this methodology will consist of two Resource IDs:

- A consumption Resource ID to account for the energy storage charging alone; and
- A curtailment Resource ID to account for the energy storage discharging to offset onsite Demand and, including if the Demand Response Provider elects, any Demand curtailment by the onsite Load independent of the energy storage.

The CAISO will use reasonable efforts to optimize both Resource IDs to avoid conflicting Schedules. Scheduling Coordinators will be responsible for calculating separate Customer Load and Generator Output Baselines for the curtailment Resource ID and the consumption Resource ID.

- (a) Meter Data will be collected for each Resource ID for the fifteen (15) minute interval as the Trading Interval on calendar days preceding the Trading Day on which the Demand Response Event occurred for which the baselines are calculated. To determine the fifteen (15) minute intervals for which the Meter Data will be collected, the calculation will work sequentially backwards from the Trading Day under examination up to a maximum of forty-five (45) calendar days prior to the Trading Day, including only business days if the Trading Day is a business day, including only non-business days if the Trading Day is a non-business day, and excluding intervals in which the Proxy Demand Resource was subject to an Outage or previously provided Demand Response Services (other than

capacity awarded for AS or RUC). The calculation will have complete Meter Data for this purpose if and when it is able to collect Meter Data for its target number of intervals the same as the Trading Interval, which target number is ten (10) intervals if the Trading Day is a business day or four (4) intervals if the Trading Day is a non-business day. If these targets cannot be met, a minimum of five (5) intervals if the Trading Day is a business day or a minimum of four (4) intervals if the Trading Day is a non-business day must be collected. If these targets cannot be met, the baselines will be set at zero.

- (b) Meter Data for the consumption Resource ID will include only Meter Data at or below 0 MWh. In intervals where the Meter Data is above 0 MWh, the Scheduling Coordinator will consider the Meter Data at 0 MWh for the consumption Resource ID.
- (c) Meter Data for the curtailment Resource ID will include only Meter Data at or above 0 MWh. In intervals where the Meter Data is below 0 MWh, the Scheduling Coordinator will consider the Meter Data at 0 MWh for the curtailment Resource ID. The Scheduling Coordinator will exclude Meter Data for Energy from the curtailment Resource ID that exceeds the onsite Demand.
- (d) The Scheduling Coordinator will be responsible for calculating the simple hourly average of the collected Meter Data to determine the baseline amounts of Energy provided or consumed by each Resource ID.

The Demand Response Provider may elect to include Demand Response Energy Measurements for the onsite Load, which the Scheduling Coordinator will add to the Demand Response Energy Measurement for the curtailment Resource ID pursuant to Section 11.6.7. If the Demand Response Provider elects to do so, the Scheduling Coordinator will calculate a separate Customer Load Baseline for the onsite Load, excluding the Energy or Demand from the energy storage. If the onsite Load is residential, the Scheduling Coordinator may calculate its Customer Load Baseline using the ten-in-ten methodology, five-in-ten methodology, or weather matching methodology performance methodology. If the onsite Load is non-residential, the Scheduling Coordinator may calculate its Customer Load Baseline using the ten-in-ten methodology or weather matching methodology performance methodology.

* * * * *

Section 11

* * * * *

11.6.7 Settlement of Proxy Demand Resources using the Load-Shift Methodology

The CAISO will settle separately the consumption Resource ID and curtailment Resource ID of a Proxy Demand Resource using the load-shift methodology. The Demand Response Energy Measurement for the consumption Resource ID will be the quantity of Energy equal to the difference between (i) its Customer Load Baseline calculated pursuant to Section 4.13.4.7 and (ii) its actual underlying negative Energy for a Demand Response Event. The Demand Response Energy Measurement for the curtailment Resource ID will be the quantity of Energy from the behind-the-meter energy storage equal to the difference between (i) its Generator Output Baseline calculated pursuant to Section 4.13.4.7 and (ii) its actual underlying production for a Demand Response Event. If the Proxy Demand Resource elects to curtail local onsite Demand independent of the behind-the-meter energy storage, the Scheduling Coordinator will add the Demand Response Energy Measurement calculated for the onsite Load pursuant to this Section 11.6 to the Demand Response Energy Measurement of the curtailment Resource ID. Scheduling Coordinators will be responsible for calculating and submitting Demand Response Energy Measurements in 5-minute intervals. For monitoring, compliance, and audit purposes, Scheduling Coordinators must submit in the Settlement Quality Meter Data Systems the Generator Output and Customer Load Baselines, as applicable, and the actual underlying consumption or Energy during all hourly intervals for the calendar days for which the Meter Data was collected to develop them pursuant to Section 4.13.4. Only Demand Response Energy Measurements will be considered Settlement Quality Meter Data. Demand Response Energy Measurements for Proxy Demand Resources will only be settled in intervals where their total Expected Energy is above zero. The CAISO will calculate the respective bid cost recoveries for each Resource ID consistent with Section 11.8. The consumption Resource ID will not recover Start-Up Costs, Minimum Load Costs, Pumping Costs, Pump Shut-Down Costs, or Transition

Costs, but may recover Energy Bid Costs.

* * * * *

Section 30

* * * * *

30.6.1.2 Bidding and Scheduling of Proxy Demand Resources using the Load-Shift Methodology

Scheduling Coordinators for Proxy Demand Resources using the load-shift methodology described in Section 4.13.4.7 will submit separate Economic Bids for the curtailment Resource ID and the consumption Resource ID that comprise the Proxy Demand Resource. The CAISO will use reasonable efforts to optimize both Resource IDs to avoid sending conflicting Schedules.

The CAISO will only accept the following types of Bids for the curtailment Resource ID:

- (i) Economic Bids for Energy or Ancillary Services;
- (ii) submissions to Self-Provide Ancillary Services;
- (iii) submissions of Energy Self-Schedules where the curtailment Resource ID has provided Submissions to Self-Provide Ancillary Services;
- (iv) submissions of Energy Self-Schedules in the Real-Time Market up to curtailment Resource ID's Day-Ahead Market Schedule in the same Trading Hour; and
- (v) RUC Availability Bids.

All Economic Bids for Energy for the curtailment Resource ID must be above the Market Clearing Prices established in Section 30.6.3. For the consumption Resource ID, the CAISO will only accept Economic Bids for Energy and submissions of Energy Self-Schedules in the Real-Time Market up to its Day-Ahead Market Schedule in the same Trading Hour. All Economic Bids for the consumption Resources must be below \$0/MWh.

* * * * *

Section 40

* * * * *

40.8.1.13 Proxy Demand Resources

A Proxy Demand Resource must have the ability to (i) be dispatched for at least twenty-four hours per month, (ii) be dispatched on at least three consecutive days, and (iii) respond for at least four hours per dispatch in order to qualify as Resource Adequacy Capacity. The Qualifying Capacity of a Proxy Demand Resource, for each month, will be based on the resource's average monthly historic demand reduction performance during that same month during the Availability Assessment Hours, as described in Section 40.9.3, using a three-year rolling average. For a Proxy Demand Resource with fewer than three years of performance history, for all months for which there is no historic data, the CAISO will utilize a monthly megawatt value as certified and reported to the CAISO by the Demand Response Provider; otherwise, where available, the CAISO will use the average of historic demand reduction performance data available, by month, for a Proxy Demand Resource. Where a Proxy Demand Resource uses the load-shift methodology to calculate its Demand Response Energy Measurements, its Qualifying Capacity will exclude demand reduction performance from the consumption Resource ID.

Attachment B – Marked Tariff

ESDER Phase 3B

California Independent System Operator Corporation

July 16, 2020

Appendix A

- Electric Vehicle Supply Equipment (EVSE)

Load, Energy, and storage resources consisting of charging stations, charging docks, or other facilities used to interconnect and supply Energy to electric vehicles.

* * * * *

Section 4

* * * * *

4.13.3 Identification of RDRRs and PDRs

Each Demand Response Provider shall provide data, as described in the Business Practice Manual, identifying each of its Reliability Demand Response Resources or Proxy Demand Resources and such information regarding the capacity and the operating characteristics of the Reliability Demand Response Resource or Proxy Demand Resource as may be reasonably requested from time to time by the CAISO. All information provided to the CAISO regarding the operational and technical constraints in the Master File shall be accurate and actually based on physical characteristics of the resources. Demand Response Providers for Proxy Demand Resources may elect to specify in the Master File how the Proxy Demand Resource will bid and be dispatched in the Real-Time Market: in (i) Hourly Blocks, (ii) fifteen (15) minute intervals, or (iii) five (5) minute intervals. Proxy Demand Resources using the load-shift methodology described in Section 4.13.4.7 may elect to bid and be dispatched in the Real-Time Market in fifteen (15) minute intervals or five (5) minute intervals. If Demand Response Providers do not submit an election in the Master File, the CAISO will set five (5) minute intervals as the default.

4.13.4 Performance Evaluation Methodologies for PDRs and RDRRs

The following methodologies may be utilized to calculate Customer Load Baselines and Demand Response Energy Measurements for Proxy Demand Resources and Reliability Demand Response Resources. Proxy Demand Resources and Reliability Demand Response Resources consisting of residential End Users may elect to use the ten-in-ten methodology, metering generator output methodology, control group methodology, five-in-ten methodology, or weather matching methodology. Proxy Demand Resources and Reliability Demand Response Resources consisting of non-residential End Users may elect to use the ten-in-ten methodology, metering generator output methodology, control group methodology, or weather matching methodology. Proxy Demand Resources with behind-the-meter energy storage also may elect to use the load-shift methodology. If an EVSE elects to participate as a Proxy Demand Resource and use a different methodology than its co-located Load, it must adhere to Section 4.13.4.6. Proxy Demand Resources providing Ancillary Services must submit Meter Data for the intervals immediately preceding, during, and following the Trading Interval(s) in which the Proxy Demand ~~Response~~ Resources were awarded Ancillary Services. As specified in the Business Practice Manual, the CAISO will retain authority to calculate or correct Customer Load Baselines and Demand Response Energy Measurements for those resources that used the CAISO's Demand Response System, until all relevant metering, settlement, and correction windows have lapsed since the CAISO retired its ability to calculate on behalf of Scheduling Coordinators in the Demand Response System.

* * * * *

4.13.4.6 Electric Vehicle Supply Equipment (EVSE)

Proxy Demand Resources may include or consist entirely of EVSEs. Proxy Demand Resources may elect to use different methodologies to calculate the Customer Load Baselines and Demand Response Energy Measurements of (i) their EVSEs, including electric vehicle charging Load, and (ii) any other Load or behind-the-meter Generation participating as Proxy Demand Resources. Where a Proxy Demand Resource elects to do so, the EVSE Load must be metered separately from any other Load or Generation. Individual EVSEs may be aggregated into Proxy Demand Resources consistent with Section 4.13.2. Where the Load at the EVSE's Location also participates as a Proxy Demand Resource, the

EVSE must participate in the same Proxy Demand Resource, but may elect to have a separately metered Customer Load Baseline and Demand Response Energy Measurement consistent with this Section. To calculate EVSE Customer Load Baselines and Demand Response Energy Measurements under this section, non-residential EVSEs may use the ten-in-ten methodology, and residential EVSEs may use the ten-in-ten methodology and the five-in-ten methodology. Scheduling Coordinators for EVSEs participating under this section will not apply an adjustment factor pursuant to subsection (c) of either methodology. Non-EVSE Load also participating in the EVSE's Proxy Demand Resource may use any eligible methodology for its Customer Load Baseline and Demand Response Energy Measurement.

4.13.4.7 Load-Shift Methodology

Only Proxy Demand Resources using behind-the-meter energy storage may elect to use the load-shift methodology described in this Section. The energy storage must be metered separately from other Load or Generation. Proxy Demand Resources using this methodology will consist of two Resource IDs:

- A consumption Resource ID to account for the energy storage charging alone; and
- A curtailment Resource ID to account for the energy storage discharging to offset onsite Demand and, including if the Demand Response Provider elects, any Demand curtailment by the onsite Load independent of the energy storage.

The CAISO will use reasonable efforts to optimize both Resource IDs to avoid conflicting Schedules. Scheduling Coordinators will be responsible for calculating separate Customer Load and Generator Output Baselines for the curtailment Resource ID and the consumption Resource ID.

- (a) Meter Data will be collected for each Resource ID for the fifteen (15) minute interval as the Trading Interval on calendar days preceding the Trading Day on which the Demand Response Event occurred for which the baselines are calculated. To determine the fifteen (15) minute intervals for which the Meter Data will be collected, the calculation will work sequentially backwards from the Trading Day under examination up to a maximum of forty-five (45) calendar days prior to the Trading Day, including only business days if the Trading Day is a business day, including only non-business days if the Trading Day is a non-business day, and excluding intervals in which the Proxy Demand Resource was

subject to an Outage or previously provided Demand Response Services (other than capacity awarded for AS or RUC). The calculation will have complete Meter Data for this purpose if and when it is able to collect Meter Data for its target number of intervals the same as the Trading Interval, which target number is ten (10) intervals if the Trading Day is a business day or four (4) intervals if the Trading Day is a non-business day. If these targets cannot be met, a minimum of five (5) intervals if the Trading Day is a business day or a minimum of four (4) intervals if the Trading Day is a non-business day must be collected. If these targets cannot be met, the baselines will be set at zero.

(b) Meter Data for the consumption Resource ID will include only Meter Data at or below 0 MWh. In intervals where the Meter Data is above 0 MWh, the Scheduling Coordinator will consider the Meter Data at 0 MWh for the consumption Resource ID.

(c) Meter Data for the curtailment Resource ID will include only Meter Data at or above 0 MWh. In intervals where the Meter Data is below 0 MWh, the Scheduling Coordinator will consider the Meter Data at 0 MWh for the curtailment Resource ID. The Scheduling Coordinator will exclude Meter Data for Energy from the curtailment Resource ID that exceeds the onsite Demand.

(d) The Scheduling Coordinator will be responsible for calculating the simple hourly average of the collected Meter Data to determine the baseline amounts of Energy provided or consumed by each Resource ID.

The Demand Response Provider may elect to include Demand Response Energy Measurements for the onsite Load, which the Scheduling Coordinator will add to the Demand Response Energy Measurement for the curtailment Resource ID pursuant to Section 11.6.7. If the Demand Response Provider elects to do so, the Scheduling Coordinator will calculate a separate Customer Load Baseline for the onsite Load, excluding the Energy or Demand from the energy storage. If the onsite Load is residential, the Scheduling Coordinator may calculate its Customer Load Baseline using the ten-in-ten methodology, five-in-ten methodology, or weather matching methodology performance methodology. If the onsite Load is non-residential, the Scheduling Coordinator may calculate its Customer Load Baseline using the ten-in-ten methodology or weather matching methodology performance methodology.

* * * * *

Section 11

* * * * *

11.6.7 Settlement of Proxy Demand Resources using the Load-Shift Methodology

The CAISO will settle separately the consumption Resource ID and curtailment Resource ID of a Proxy Demand Resource using the load-shift methodology. The Demand Response Energy Measurement for the consumption Resource ID will be the quantity of Energy equal to the difference between (i) its Customer Load Baseline calculated pursuant to Section 4.13.4.7 and (ii) its actual underlying negative Energy for a Demand Response Event. The Demand Response Energy Measurement for the curtailment Resource ID will be the quantity of Energy from the behind-the-meter energy storage equal to the difference between (i) its Generator Output Baseline calculated pursuant to Section 4.13.4.7 and (ii) its actual underlying production for a Demand Response Event. If the Proxy Demand Resource elects to curtail local onsite Demand independent of the behind-the-meter energy storage, the Scheduling Coordinator will add the Demand Response Energy Measurement calculated for the onsite Load pursuant to this Section 11.6 to the Demand Response Energy Measurement of the curtailment Resource ID. Scheduling Coordinators will be responsible for calculating and submitting Demand Response Energy Measurements in 5-minute intervals. For monitoring, compliance, and audit purposes, Scheduling Coordinators must submit in the Settlement Quality Meter Data Systems the Generator Output and Customer Load Baselines, as applicable, and the actual underlying consumption or Energy during all hourly intervals for the calendar days for which the Meter Data was collected to develop them pursuant to Section 4.13.4. Only Demand Response Energy Measurements will be considered Settlement Quality Meter Data. Demand Response Energy Measurements for Proxy Demand Resources will only be settled in intervals where their total Expected Energy is above zero. The CAISO will calculate the respective bid cost recoveries for each Resource ID consistent with Section 11.8. The consumption Resource ID will not

recover Start-Up Costs, Minimum Load Costs, Pumping Costs, Pump Shut-Down Costs, or Transition Costs, but may recover Energy Bid Costs.

* * * * *

Section 30

* * * * *

30.6.1.2 Bidding and Scheduling of Proxy Demand Resources using the Load-Shift

Methodology

Scheduling Coordinators for Proxy Demand Resources using the load-shift methodology described in Section 4.13.4.7 will submit separate Economic Bids for the curtailment Resource ID and the consumption Resource ID that comprise the Proxy Demand Resource. The CAISO will use reasonable efforts to optimize both Resource IDs to avoid sending conflicting Schedules.

The CAISO will only accept the following types of Bids for the curtailment Resource ID:

- (i) Economic Bids for Energy or Ancillary Services;
- (ii) submissions to Self-Provide Ancillary Services;
- (iii) submissions of Energy Self-Schedules where the curtailment Resource ID has provided Submissions to Self-Provide Ancillary Services;
- (iv) submissions of Energy Self-Schedules in the Real-Time Market up to curtailment Resource ID's Day-Ahead Market Schedule in the same Trading Hour; and
- (v) RUC Availability Bids.

All Economic Bids for Energy for the curtailment Resource ID must be above the Market Clearing Prices established in Section 30.6.3. For the consumption Resource ID, the CAISO will only accept Economic Bids for Energy and submissions of Energy Self-Schedules in the Real-Time Market up to its Day-Ahead Market Schedule in the same Trading Hour. All Economic Bids for the consumption Resources must be below \$0/MWh.

* * * * *

Section 40

* * * * *

40.8.1.13 Proxy Demand Resources

A Proxy Demand Resource must have the ability to (i) be dispatched for at least twenty-four hours per month, (ii) be dispatched on at least three consecutive days, and (iii) respond for at least four hours per dispatch in order to qualify as Resource Adequacy Capacity. The Qualifying Capacity of a Proxy Demand Resource, for each month, will be based on the resource's average monthly historic demand reduction performance during that same month during the Availability Assessment Hours, as described in Section 40.9.3, using a three-year rolling average. For a Proxy Demand Resource with fewer than three years of performance history, for all months for which there is no historic data, the CAISO will utilize a monthly megawatt value as certified and reported to the CAISO by the Demand Response Provider; otherwise, where available, the CAISO will use the average of historic demand reduction performance data available, by month, for a Proxy Demand Resource. Where a Proxy Demand Resource uses the load-shift methodology to calculate its Demand Response Energy Measurements, its Qualifying Capacity will exclude demand reduction performance from the consumption Resource ID.

Attachment C – Draft Final Proposal

ESDER Phase 3B

California Independent System Operator Corporation

July 16, 2020



California ISO

Energy Storage and Distributed Energy Resources Phase 3

Draft Final Proposal

July 11, 2018

Market & Infrastructure Policy

Table of Contents

1	Introduction	3
2	Stakeholder Process	4
3	Energy Imbalance Market Classification	4
4	Response to Stakeholder Comments	5
5	Demand Response Resources	9
5.1	Demand response modeling limitations.....	9
5.1.1	Proposal	10
5.2	Removal of the single LSE requirement and default load adjustment.....	13
5.2.1	Proposal	14
5.3	Load Shift Product.....	16
5.3.1	Proposal	17
5.4	Recognition of behind the meter EVSE load curtailment.....	23
5.4.1	Proposal	24
5.5	Multiple-Use Applications.....	25
5.6	Non-Generator Resources	26
6	Future Considerations	27
Appendix A	Acronyms.....	29

1 Introduction

The focus of the California Independent System Operator's (CAISO) energy storage and distributed energy resources (ESDER) initiative is to lower barriers and enhance the abilities for energy storage and distribution-connected resources¹ to participate in the CAISO markets. The growing number and diversity of these resources are beginning to represent an increasingly important part of the future grid.

The ESDER initiative is an omnibus initiative with annual phases covering several related but distinct topics. The second phase of ESDER developed enhancements to demand response (DR), non-generator resources (NGR), multiple-use applications (MUA), and station power for storage resources.

The CAISO published a revised straw proposal on April 30, 2018 identifying the scope for ESDER 3 along with proposed policy. Subsequent to the release of the revised straw proposal, the CAISO has held both a working group meeting and conference call to further develop proposal details with stakeholders. This draft final proposal will be submitted for approval to the CAISO Board of Governors in September. Upon receipt of approval, a tariff filing with FERC will be made.

The following describes the scope of the ESDER 3:

- Demand Response – Four enhancements to current demand response participation models are proposed: (1) new bidding and real-time dispatch options, (2) removal of the single load serving entity (LSE) aggregation requirement along with need for the settlement application of a default load adjustment (DLA), (3) development of an energy storage load shift product, and (4) recognition of sub-metered electric vehicle supply equipment (EVSE) load curtailment separate contribution to resource performance.
- Multiple-Use Application (MUA) – CAISO has yet to identify specific tariff and market design changes that can be proposed within ESDER3 based on current developments in the CPUC working group. While not proposing any changes at this time, the CAISO will continue actively participating in the working group and reevaluate once the final report is submitted to the CPUC commission.
- Non-Generator Resource (NGR) – The CAISO is not proposing any changes to the current NGR participation model.

¹ DERs are those resources on the distribution system on either the utility side or the customer side of the end-use customer meter, including rooftop solar, energy storage, plug-in electric vehicles, and demand response.

2 Stakeholder Process

The CAISO is at the draft final proposal stage in the ESDER 3 stakeholder process. Figure 1 below shows the status of the draft final proposal within the overall ESDER 3 stakeholder process.

The purpose of the draft final proposal is to present the final scope and solutions of issues related to the integration, modeling, and participation of energy storage and DERs in the CAISO market. The CAISO has reviewed stakeholder feedback through comments and working group meetings in developing the final proposal to be presented to the CAISO Board of Governors, Energy Imbalance Market Governing Body, and final tariff approval from FERC.

Figure 1: Stakeholder Process for ESDER 3 Stakeholder Initiative

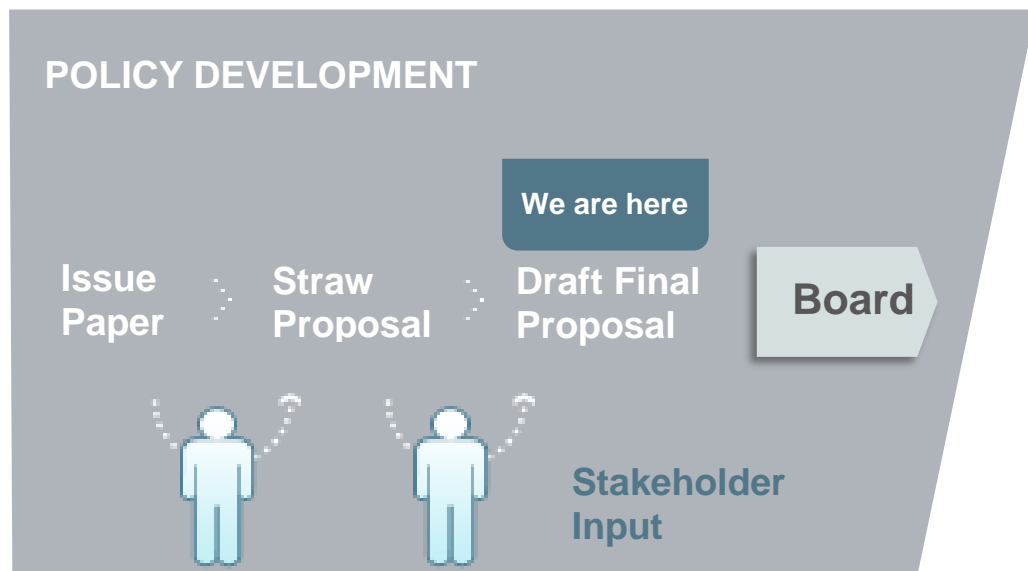

3 Energy Imbalance Market Classification

CAISO staff believes that ESDER 3 involves the Energy Imbalance Market (EIM) Governing Body's advisory role to the Board of Governors (Governing Body – E2 classification). This initiative proposes four changes to the proxy demand resource (PDR) and reliability demand response resource (RDRR) model with the aim of reducing barriers to participation and enhancing their ability to provide services in the day-ahead and real-time markets. While proposed enhancements to the CAISO's demand response participation models will be applicable to demand response participation models utilized by EIM participants, there are no changes specific to EIM balancing authority areas. The demand response enhancements are:

1. PDRs ~~and RDRRs~~ ability to bid as an hourly or 15-minute dispatchable resource to provide real-time dispatch enhancements;
2. Adding a component to allow a PDR to increase consumption by charging behind the meter energy storage (battery);
3. A new performance measurement recognizing Electric Vehicle Supply Equipment as an independent load curtailment contributor participating under the PDR model;
4. Eliminate the requirement for PDR and RDRR resources to be composed of service accounts under one LSE while maintaining the single sub-Lap requirements.

All of the new proposed features would apply generally throughout the ISO market, and thus be advisory for the EIM Governing Body.

4 Response to Stakeholder Comments

The following section provides responses to stakeholder comments since the posting of the revised straw proposal on April 30, 2018.

Section 5.1 – Demand response modeling limitations

The CAISO corrected a description of the hourly bid option in which the resource will be a “price taker” for the full hour and will not receive a guaranteed price in the first 15-minute interval as previously stated. In addition, the proposal updated the new name for the Imbalance Reserve Product in the Day-Ahead Markets Enhancement (DAME) initiative, to the day ahead flexible ramping product (FRP). Lastly, the CAISO is proposing that PDRs with an hourly block bid have the option to be cleared in the day-ahead market but not be considered in RUC.

A majority of stakeholders support the bidding options proposal. CLECA requested clarification on the market award for the hourly bidding option. The CAISO has corrected the proposal to state that a resource will be a “price taker” over the full hour it is scheduled at the 15-minute market price. CLECA also requested the CAISO consider an option to guarantee the first 15-min interval price under the hourly bid option. This option is not feasible since the Hour Ahead Scheduling Process (HASP) runs approximately 45 minutes before the hour and the dispatch is based on advisory prices. Specifically, the resource’s hourly block is scheduled before the first 15-min interval price is set and 22.5 minutes before the first binding interval, therefore, all four pricing intervals of the hour are advisory. Additionally, CLECA submitted comments on the

need for minimum run time changes to the demand response model. The CAISO believes that the proposed bidding options allows for DR resources to receive the advanced notification needed for real time response and enables resources to be dispatched hourly, if needed.

Section 5.2 – Removal of the single LSE requirement and default load adjustment

No major changes were proposed in the draft final proposal.

A majority of stakeholders support the proposal. SCE requested clarification on SIBR treatment of bids at the NBT threshold price. The CAISO has made the clarification in the proposal that SIBR will only accept bids at or above the NBT threshold price.

Section 5.3 – Load Shift Product

The CAISO provided further details on the design of the proxy demand resource - load shift resource (PDR-LSR). The PDR-LSR is a demand response resource providing both load curtailment and dispatchable consumption to provide “energy shift.” To participate, a resource will register two separate resource IDs containing the same service accounts (Resource ID – curtailment, Resource ID- consumption). The CAISO has included an example (see attachment) for the scenario in which a facility and sub-metered energy storage participates as a PDR-LSR. The CAISO has also clarified in its description of the performance evaluation calculation, the need for 15-minute granularity in determining event/non-event intervals.

A majority of stakeholders have either expressed support or have not expressed a position on the proposal. SCE requested further information on the CAISO’s shift from moving to event day to event hours when calculating the baseline for PDRs. The CAISO clarifies that the use of event hours rather than event days was established with the metered generation output (MGO) methodology in ESDER 1 and only applies to development of a baseline to determine the typical use of a sub-metered energy storage device. PDR/RDRRs utilizing the current day matching customer load baseline (CLB) performance methodology will continue to use event days and not event hours. The CAISO moved towards a more granular approach in event intervals to capture the typical use of the energy storage device. The CAISO does not believe an event that occurred at an earlier interval justifies the removal of an entire day. The assessment of 15-minute intervals will only apply to PDR-LSRs. Event hours will continue to remain for PDR/RDRRs utilizing the MGO methodology, and event days for PDR/RDRRs using all other CAISO approved baseline methodologies. Olivine requested the use for “event days” and questioned the rationale behind the separate calculation between a facility’s load curtailment and the development of typical use for a sub-metered storage resource. The CAISO’s rationale for separating the baseline calculation between the

facility load and sub-metered storage resource is because it keeps the treatment consistent with the FERC approved MGO baseline.² In response to SCE's comment on the registration of the PDR-LSR, the CAISO clarified in its proposal that the same service accounts must be used for participation in both curtailment and consumption. SCE has also requested clarification on the consideration of retail charging for the energy storage device in the baseline. The PDR-LSR will consider both non-event charge and discharge values for a given interval, which takes into account retail charging in the calculation of the typical use value. In response to Olivine's clarifying question, PDR-LSRs can buy back day-ahead consumption awards in real-time.

The CAISO Department of Market Monitoring (DMM) detailed potential conflicting dispatch scenarios.³

1. *"Scenario 1: The curtailment resource has a minimum run time of 1 hour and is scheduled through HE21. The curtailment resource is economic in the first two intervals of HE 21 (intervals 00 and 15) and scheduled at 5MW, but is ramped down starting in the third interval of HE 21 (interval 30). The curtailment resource is uneconomic in interval 30, but its ramp rate only enables it to ramp to 1MW by interval 30. Meanwhile, the consumption resource is economically dispatched to consume starting interval 30."*

The CAISO will enforce ramp rates for a PDR-LSR to be fully dispatchable between Pmin and Pmax in either 15 or 5 minutes, depending on its elected bidding option. Enforcing the ramp rate will ensure that each resource (consumption/curtailment) will meet its dispatch in a given interval. In the scenario above, the curtailment resource would need to meet its dispatch by the end of the third interval and the consumption resource would follow the dispatch to increase load.

2. *"Scenario 2: The curtailment resource has a start-up time of 1 hour and receives dispatches starting HE18 for 5MW. The consumption resource is economic during curtailment resource's start-up time. The consumption resource could receive consumption dispatches during HE17 when curtailment resource's start-*

² See ESDER Phase 1 Revised Draft Final Proposal
(<http://www.caiso.com/Documents/RevisedDraftFinalProposal-EnergyStorageDistributedEnergyResources.pdf>)

³ For further details please refer to DMM's comments
(<http://www.caiso.com/Documents/DMMComments-EnergyStorage-DistributedEnergyResourcesPhase3-Jun252018.pdf>)

up time is honored. The curtailment resource requires advanced notice to curtail/generate as specified by its start-up time, but the consumption resource may be dispatched to increase load leading up to the curtailment.”

The PDR-LSR’s design will utilize existing market functionalities. The consumption resource, will be designed in similar fashion to the existing NGR model, which will not have certain parameters such as startup time. In contrast, the curtailment resource ID will reflect the same parameters as PDRs have today.

3. *“Scenario 3: Even if the curtailment resource has a 0 MW Pmin and both IDs have infinite ramp, the curtailment resource and consumption resource can receive two different dispatch instructions in the same interval. Suppose the curtailment resource is scheduled through HE21 and its minimum run time of 1 hour is honored. However, the curtailment resource is no longer economic starting HE21 interval 30 and is dispatched down, sitting at 0MW through the balance of hour. Meanwhile, the consumption resource is economically dispatched to consume through the balance of HE21.*

Starting HE22, the system needs additional supply. The market schedules the curtailment resource to ramp up (curtail/supply) and the consumption resource to reduce consumption.

Starting HE22, the curtailment resource is asked to curtail (supply) 5MW and the consumption resource is asked to curtail (reduce consumption) 5MW. The market schedules 10 MWs of movement on the single resource between HE21 Int45 and HE22 Int00, not just 5MW of supply on curtailment resource.”

The CAISO understands the scenario in which both resource IDs will be expected to respond to a dispatch. The CAISO does not have any operational concerns with the dispatch scenario above because it was a valid decision made by the market optimization system. The CAISO will monitor for this scenario with the implementation of the PDR-LSR.

Section 5.4 – Measurement of EVSE performance

No major changes were proposed in the draft final proposal

A majority of stakeholders supported the EVSE proposal. SCE stated that it “retains its concern on EVSE sub-metering regarding the lack of a dedicated meter for the resource.” The CAISO has understood SCE’s concerns as well as the positions of other stakeholders and have made the decision to move forward with the proposal. But, it will continue to monitor the potential use-cases SCE had presented.

5 Demand Response Resources

The CAISO is proposing the following enhancements to the Proxy Demand Resource (PDR) and Reliability Demand Response Resource (RDRR) participation models.

5.1 Demand response modeling limitations

DR resources are successfully integrated into the CAISO market and aide in meeting system reliability. The CAISO is looking to continue market design enhancements to provide DR resources options to inform the CAISO of its operating characteristics to align the market optimization of these resources in the day-ahead and real-time market processes.

Minimum and Maximum Run-Time Constraints

The CAISO understands the conflict due to a DR resource’s Pmin of 0 MW and the CAISO market optimization. Today, the CAISO market systems will issue a start-up instruction to a DR resource to their Pmin, often 0 MW, well in advance of the commitment hour in the real-time market. This commitment ensures both start-up and minimum runtime constraints are met, however, since the resource is considered “running” at a Pmin of 0 MW, it is available for dispatch whenever the resource’s energy bid is economic. This can result in 5-minute dispatch instructions that have only a 2.5-minute notification time. Certain affected stakeholders have explained that this notification time is infeasible for many PDRs. Figure 2 below represents this scenario.

Figure 2: Commitment of DR resource with a Pmin of 0 MW

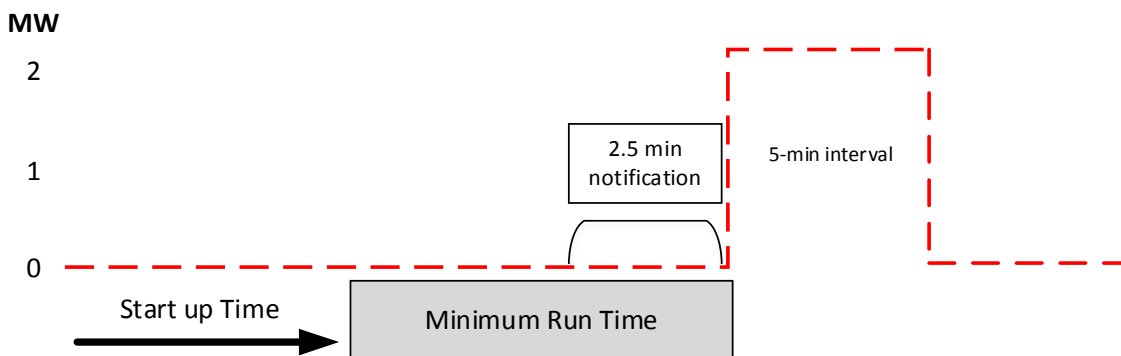

The CAISO respects the resource’s minimum run-time constraint when committing at Pmin, represented in Figure 2 as the gray horizontal bar. However, the minimum run-

time constraint at times may be met while the resource is at a Pmin of 0 MW, which is dispatched above its Pmin, represented as the dashed red line above.⁴ Stakeholders have suggested that the PDR participation model does not effectively recognize two constraints:

- (1) Recognition of the minimum run time when the resource is dispatched above its Pmin of 0 MW;
- (2) Limitation in using the maximum daily energy limit instead of a maximum run time to recognize daily use limitations.

5.1.1 Proposal

Hourly and 15 minute bidding option for PDRs

The CAISO is proposing to offer bidding options for PDRs/~~RDRRs~~ that will provide longer notification times and extended real-time dispatch intervals, similar to what the CAISO currently offers to intertie resources. The CAISO introduced this option and its application to PDRs/~~RDRRs~~ in a joint workshop with the CPUC on October 4, 2017.⁵ Additionally, PDRs that elect the hourly bid option will also be eligible to be cleared in the day-ahead market but not be considered in RUC.⁶

The CAISO believes applying an hourly economic bidding and real-time dispatch model to PDRs/~~RDRRs~~, which require longer notification time or cannot respond to 5-minute dispatches, provides them with an additional alternatives to viably participate in the real-time market. The CAISO's goal is to leverage existing market functionality, where possible, to enable demand response resources to participate more effectively and efficiently in the market.

Pre-Market

⁴ Definition of minimum run time

http://www.caiso.com/Documents/Section34_RealTimeMarket_asof_May2_2017.pdf

⁵ Link to presentation from CAISO-CPUC joint workshop introducing CAISO's 15-minute market and bidding options for real-time imports and exports, slides 51- 59.

http://www.caiso.com/Documents/Presentation_JointISO_CPUCWorkshopSlowResponseLocalCapacityResourceAssessment_Oct42017.pdf

⁶ With the future implementation of the DAME initiative, RUC will be co-optimized with the IFM. The CAISO will award resources that are willing to be dispatched in FMM and/or RTD DA flexible ramping product. PDR resources that cannot be dispatched in FMM and/or RTD can register this limitation, which will prevent the resource from receiving a DA FRP award.

The PDR/~~RDRR~~ will register in Master File if the resource can be scheduled as an hourly block, scheduled in 15-minute intervals, or 5-minute dispatchable. Until implementation of the DAME, if a PDR elects the hourly block bid option, it can also register in Master File the option to not be considered for a RUC. Once the DAME are implemented, the IFM and RUC will be co-optimized in a single market optimization and hourly block resources will be ineligible for DA FRP awards. This option will only apply to PDRs with an hourly block bid, because the resource can only be scheduled in the real-time market during the hour ahead scheduling process (HASP).⁷ The HASP determines the hourly energy schedule by enforcing a constraint that the resources schedule for each advisory 15-minute interval is equal. Since the resource's schedule cannot be determine for each 15-minute interval, the HASP schedule is a price taker in the fifteen minute market (FMM). The process to change Master File characteristics will remain the same under the existing BPM in which changes can take anywhere from 5 to 11 business days.⁸ Once the PDR/~~RDRR~~ has registered the scheduling option, it will be required to submit bids accordingly.⁹ ~~Specific to RDRR, awards from the day-ahead market will be dispatched according to their day-ahead awards and any remaining capacity bid into the real-time market would be held back for emergency response purposes. However, when an RDRR's capacity is "released" into the market after an emergency is called, the RDRR will be dispatched according to its bid parameters.~~

Market

Once the resource elects its scheduling option in Master File, the PDR/~~RDRR~~ resource will follow one of the processes below:

- 1. Hourly block** –the SC submits a day-ahead market bid for an entire hour. In the real-time market, the resource will be scheduled via the HASP but will be settled at 15-minute market prices over the operating hour. The binding schedule is communicated to the SC at 52.5 minutes before the flow of energy. Because the resource is scheduled for the full hour, it will settle at the FMM in real time making it a “price-taker” for the full hour. In the example below, the resource is

⁷ PDRs electing the hourly block bid option without a RUC obligation can only be considered as a system RA resource.

⁸ CAISO BPM for Market Instruments, “Master File Update Procedures” Attachment B (<https://bpmcm.caiso.com/Pages/BPMDetails.aspx?BPM=Market%20Instruments>)

⁹ ~~Applicable to RDRRs that elect to economically bid in day-ahead market. All other real-time reliability bidding requirements will remain for RDRRs recognizing their reliability only bidding in the real-time market.~~

a 2 MW resource that opted to bid hourly. The CAISO respected the minimum run time parameter (1 hour) in HE 2 and 3. In HE 2, the CAISO sent a dispatch notification 52.5 minutes before the flow of energy for HE 3.

Following the market design principle laid out in CAISO's FERC 764 tariff compliance, the CAISO will not allow for bid cost recovery (BCR) for PDRs that elect an hourly bid option.¹⁰

Figure 3: Example of hourly bid option

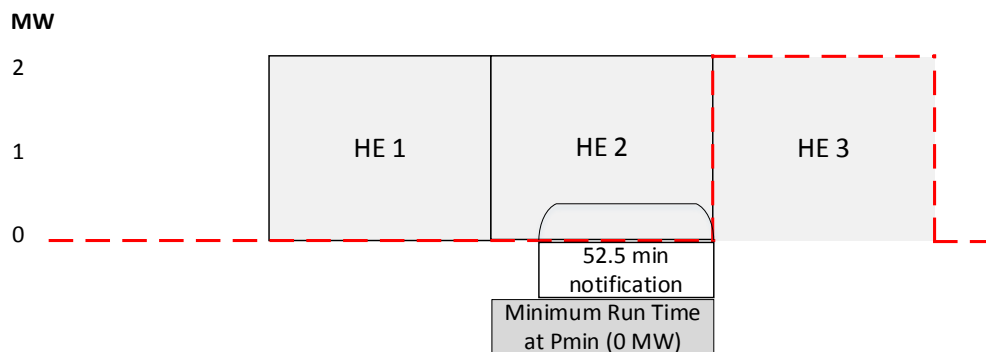

- 2. 15-minute dispatchable** – The SC will submit supply bids in hourly increments in the day-ahead market. In the real-time market, hourly energy bids are submitted no later than 75 minutes prior to the operating hour. If the 15-minute bid is economic, it will be dispatched and receive a binding schedule at the FMM price. The dispatch notification is communicated 22.5 minutes before the flow of energy is expected.

PDRs electing the 15-minute bid option will be eligible for BCR. Bid cost recovery allows a resource committed by the CAISO to recover its startup costs, minimum load costs, ancillary service bids, and energy bids over the course of the day (the 24 hours of that day). In the case that the FMM price does not cover the dispatched resource's bid-in costs, the CAISO will ensure that the resource is compensated for providing energy.

¹⁰ CAISO's tariff compliance filing on FERC Order 764 (see pg. 30-32) (http://www.caiso.com/Documents/Nov26_2013_TariffAmendment-Real-TimeMarketDesignEnhancementsRelated-Order764_ER14-480.pdf)

Figure 4: Example of 15-minute bid option

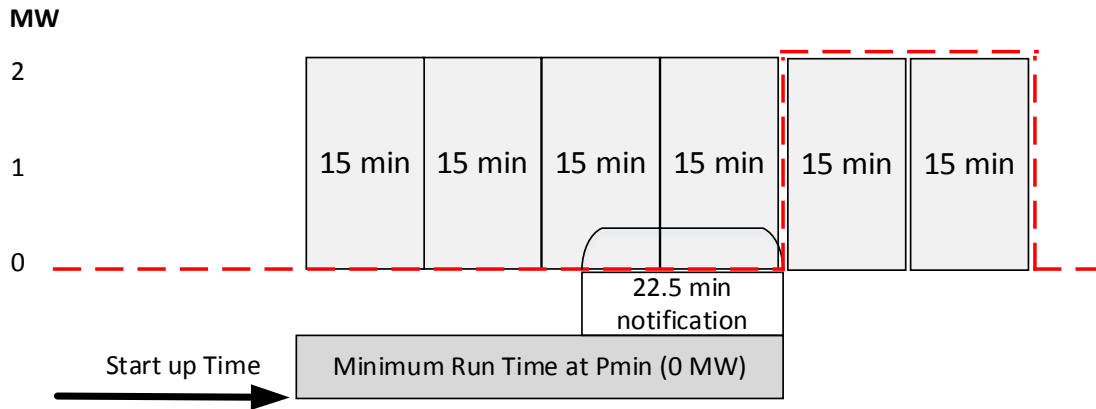

Post-Market

Currently, PDRs are settled on the 5-minute real time Locational Marginal Price (LMP). If a PDR elects an hourly or 15-minute bid option, the CAISO will settle the resource under the FMM LMP. The CAISO established the process for FMM settlement under its FERC Order No. 764 proposal.¹¹ The day-ahead energy schedule will be settled at the day-ahead LMP. Any imbalances between the FMM energy schedule and the day-ahead energy schedule is settled at the FMM LMP.

5.2 Removal of the single LSE requirement and default load adjustment

The CAISO currently requires DR resource aggregations consist of locations under a single LSE, represented by one demand response provider (DRP), and within a single sub-LAP. The CAISO originally established the single LSE requirement in its PDR policy, later replicated in the RDRR policy, to facilitate the settlement application of a LSE specific DLA.¹² This adjustment eliminated the double payment for a decrease in demand when it was not net beneficial to all purchasers in terms of a wholesale market

¹¹ CAISO Draft Final Proposal on FERC Order 764 (see pg. 18-19).
<http://www.caiso.com/Documents/DraftFinalProposal-FERC-Order764MarketChanges.pdf>

¹² The DLA represents the amount of load curtailed, based on a PDR or RDRR demand response energy measurement, within a Default LAP specific to the LSE when the real-time LMP is below the threshold price.

price reduction based on a demand response net benefits test.¹³ This design feature required segmenting a DR program into different aggregations by LSE within a single sub-LAP. DR market participants claimed this segmentation could potentially strand willing customer participants and affect the ability for some PDRs to meet the minimum wholesale market participation size requirement. In more specific cases, DRPs establishing new resource aggregations, or are in the process of developing new ones, have expressed difficulty meeting, or maintaining, the 100 kW minimum participation requirement as customers within their resource aggregations are defaulted or move to new LSEs, such as to a Community Choice Aggregation (CCA).

The DLA settlement mechanism requires PDR and RDRR aggregations to be under a single LSE. The DLA originated from FERC Order 745, which required the CAISO to implement a net benefits test (NBT).¹⁴ The NBT establishes a price threshold at which demand response resources are deemed cost effective. If the real-time market LMP is below the threshold, the DLA is triggered; resulting in the adjustment of the metered load used in the uninstructed imbalance energy (UIE) settlement of the LSE's default load aggregation point (DLAP). This mechanism is utilized to mitigate double payment for demand response services provided in intervals where the threshold price is not met but payment to the PDR or RDRR is made.

5.2.1 Proposal

The CAISO proposes to remove the single LSE requirement for DR aggregations and application of the DLA. The CAISO believes by removing the single LSE requirement, the application of the DLA becomes too complex to implement and manage across multiple LSEs under a single PDR. Additionally, the settlement implications of the DLA have historically been *de minimis* relative to the benefits achieved by eliminating the one LSE per PDR requirement (see Figure 5 and Figure 6 below).

As requested by stakeholders, the CAISO conducted an analysis of the total DLA affected MWs, their settlement impacts, and how frequently the DLA was applied in 2017. On average, the DLA calculation was triggered 4% of the month over the course of a year.¹⁵ The monthly total of demand response resource MWs identified as being provided below the NBT threshold price and settlement charges resulting from the application of

¹³ CAISO Net Benefits Test

http://www.caiso.com/Documents/IssuePaper_DemandResponseNetBenefitsTest.pdf

¹⁴ FERC Order 745 <https://www.ferc.gov/EventCalendar/Files/20110315105757-RM10-17-000.pdf>

¹⁵ Based on the number of intervals DLA was triggered/ total number intervals in a month.

the DLAs to the LSEs, are shown below in Figure 5 and Figure 6. The CAISO’s DLA settlement impact analysis, in part, supports removal of the calculation and that its removal results in a *de minimis* settlement impact. The CAISO maintains that removal of the DLA is necessary to institute an aggregation requirement, highly desirable by stakeholder, allowing multiple LSEs to be represented within a single PDR/RDRR.

Figure 5: 2017 Total Monthly DLA Impact

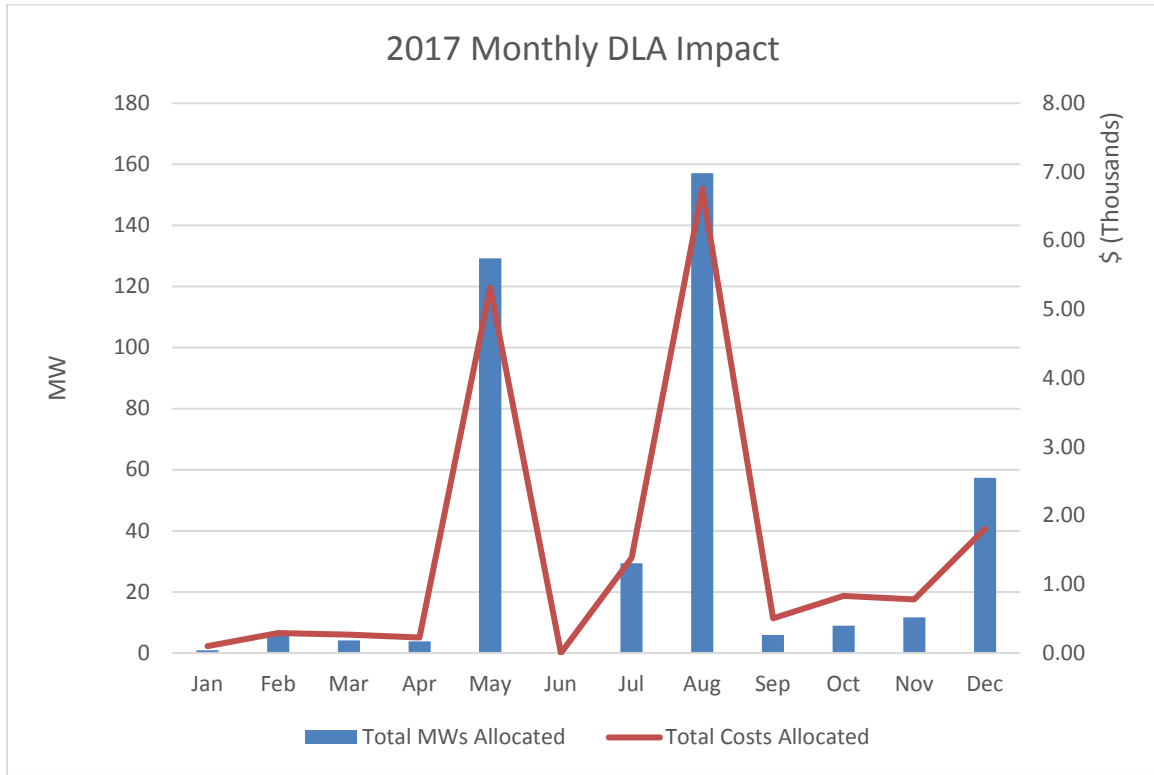
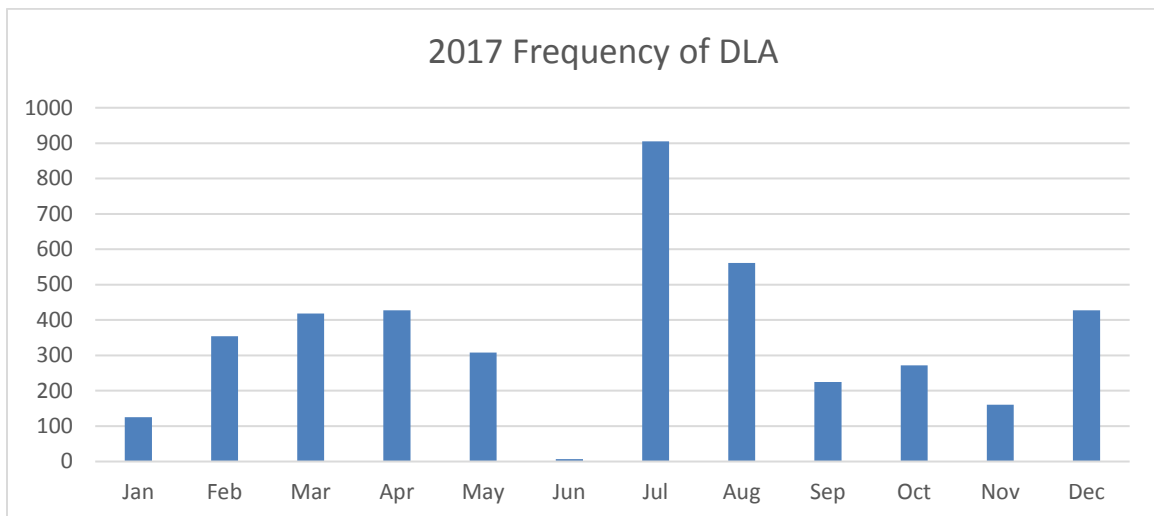

Figure 6: Number of intervals a DLA was triggered per month



Pre-market

Currently, the demand response registration process (DRRS) requires a registration for a PDR or RDRR to be composed of locations with the same LSE service accounts. The CAISO proposes to remove the single LSE aggregation rule and make appropriate changes to the DRRS as well as remove enforcement of the single LSE registration requirement.

Market

The CAISO proposes to utilize the NBT threshold price to screen submitted PDR bids in the CAISO's Software Infrastructure Business Rules (SIBR) in compliance with FERC Order No. 745. SIBR will accept bids only at or above the established net benefits threshold price. This SIBR rule bidding requirement will ensure PDR and RDRR resources are net beneficial to the system when submitting bids to the CAISO rather than an after-the-fact assessment in the settlement system. The CAISO will use the existing monthly calculation of the NBT and its resulting on-peak and off-peak threshold prices in SIBR to validate bid submissions in the day-ahead and real-time markets to ensure all energy prices in the energy bid are at or above the threshold price. If this condition is not met, SIBR will invalidate the bid and a status will be displayed on the SIBR user interface. The SC will have an opportunity to correct and re-submit valid bids until the market closes. An invalid bid cannot overwrite a bid previously submitted within that market. SIBR will continue validating submission of RDRR bids in the real time market against the current rule requiring their bid prices in the energy bid curve to be at or above 95% of the energy bid price ceiling.

Post-market

Today, the DLA application is triggered within an LSE for the intervals in which the real time LMP falls below the NBT threshold price and PDR/RDRR delivers energy. Because the CAISO will accept demand response resource bids only at or above the NBT price threshold, the CAISO will remove the DLA application.

5.3 Load Shift Product

In approving the ESDER 2 proposal, the CAISO Board of Governors requested staff continue working with stakeholders on proposals set out by the original load consumption working group for enhancing the PDR model to provide additional services during oversupply conditions.

5.3.1 Proposal

The CAISO is proposing to develop a load shift product for behind the meter (BTM) storage devices under the PDR participation model. The load shift product will fall under existing PDR policy provisions, but will develop certain functionalities allowing the resource to bid and be dispatched for both load consumption (charging, negative generation) and load curtailment (discharging, generation) from a BTM storage resource. The initial product will allow a PDR to access day-ahead and real-time energy markets for both load curtailment and load consumption capabilities through the use of two separate resource IDs. The proposal will facilitate the provision of “shift” services while maintaining a demand response policy principle that injection or export of BTM energy storage beyond the retail meter is not eligible for wholesale market compensation.

The CAISO is proposing the following features listed below:

- Participation requires direct metering of BTM energy storage
- Resource pays full retail rate for all charging energy
- Energy storage resource will maintain its own state of charge
- Load curtailment resource ID
 - Maintains RA capacity eligibility
 - Non-exporting rule applies
- Load consumption resource ID
 - Ineligible for RA capacity and ancillary services
 - Ability to bid a negative cost for load consumption energy services

Pre-market

The CAISO proposes that the PDR-LSR will facilitate the provision of load curtailment and load consumption by two discrete resources registered in Master File, one resource ID to reflect the operating characteristics of the resources curtailment capabilities and the second resource ID to reflect those of its consumption capabilities. Both resource IDs will be able to register using the same registered service accounts. At least one of the service accounts must have a behind the meter storage to qualify as a PDR-LSR.¹⁶ A

¹⁶ The CAISO at this time, defines “behind the meter storage” as a battery storage resource that can be directly metered.

resource wanting to participate under the PDR-LSR must register with both resource IDs and cannot opt to register for just the consumption functionality. PDR-LSRs may have an RA obligation for the provision of curtailment and will still have a MOO applicable to the PDR-LSR resource ID identified as such. Due to the design of two discrete resource IDs, the resource ID representing curtailment will need to register with a Pmin of 0 MW. The CAISO believes that in addition to specific bidding rules (detailed below), enforcing ramping capabilities for each resource, and the Pmin requirement during registration, will prevent scenarios in which both resource IDs will be given conflicting dispatches.

Market

To ensure that conflicting dispatches will not occur within intervals, the CAISO proposes that the PDR-LSR will be available to bid either as a 15-minute or 5-minute dispatchable resource only. Because the PDR-LSR is a single product with two resource IDs, it must bid both resource IDs consistently and exclusively. For example, if a PDR-LSR elects to be dispatchable on a 5-minute basis under the resource IDs providing consumption, it cannot elect to use the hourly or 15-minute bid option for the resource ID providing load curtailment. The PDR-LSR must maintain symmetric dispatchability for both resources by selecting the same real time bidding options for both load curtailment and consumption resource IDs.

The CAISO also proposes that the load consumption resource ID for the PDR-LSR will only be allowed to bid from the bid floor (-\$150) up to a value less than \$0. Load consumption for the purposes of the load shift product will not be allowed to bid in the positive range to prevent conflicting dispatch signals. The load curtailment resource ID will only bid at or above the NBT price threshold to the bid cap (currently at \$1,000). The CAISO is proposing to prohibit the load consumption resource ID to provide ancillary services because DR resources can only provide spin/non-spin services and not regulation. Table 1 summarizes the bidding rules and services of a PDR-LSR.

Table 1: Bidding and Energy Services

Resource ID	Bid Options ¹⁷	Bid Range	Services
Curtailment	15-min/5-min	NBT Price to Bid Cap	Energy, FRP, DA FRP
Consumption		-(Bid floor) to < \$0	

¹⁷ Bids must be uniform between both resource IDs

A PDR-LSR will be eligible for BCR. The CAISO will calculate BCR as it does today for the load curtailment resource ID. For load consumption, the CAISO will offer BCR because the resource’s bid has indicated a price to consume energy in a given interval, and may have foregone revenues of providing a service outside of the CAISO market. In the course of a day, if the resource was not able to recover its bid costs, the CAISO will make the resource whole. The CAISO will calculate the BCR for both resource IDs separately.¹⁸

Figure 7 illustrates how the resource would bid both resource IDs along with a potential corresponding award in 5-minute intervals.

Figure 7 Load Shift Resource bid stack and awards in the market

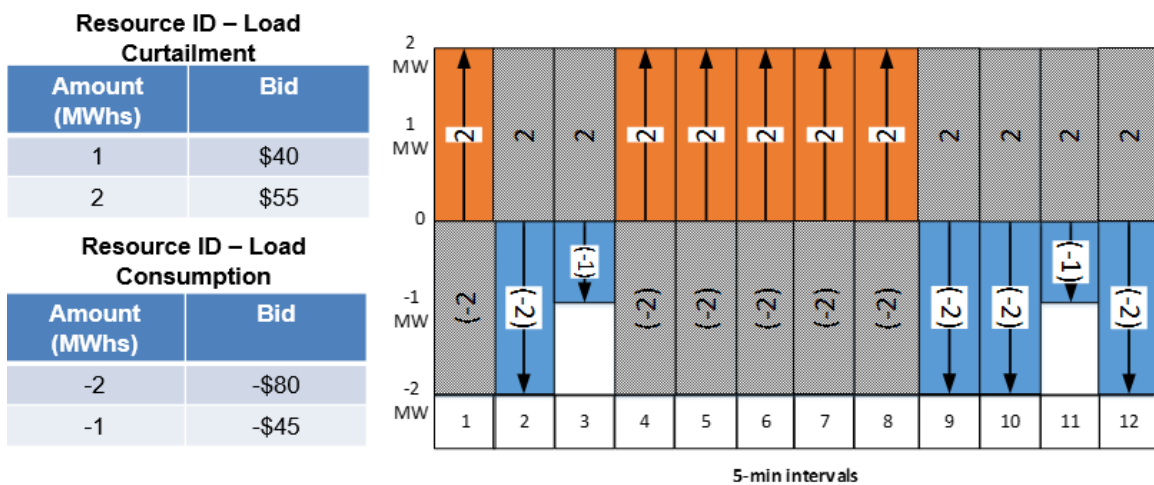

Post-market

The load curtailment resource ID will be settled under the same rules as it is today with slight modifications to how the Demand Response Energy Measurement (DREM) is developed. The load consumption resource ID will follow the same guiding principles under the load curtailment (current PDR settlement); except, the resource will settle as negative generation utilizing a separate performance measurement. The PDR-LSR will follow the same meter data submission requirements for all PDR/RDRRs.

Performance Evaluation Methodology

The SC or DRP will calculate the performance of the PDR-LSR. Each performance methodology will be referenced as either “LSR-curtailment” or “LSR-consumption.” Both methodologies will net out “typical usage” to define the incremental load

¹⁸ Please refer to the CAISO’s Department of Market Monitoring’s example on potential BCR calculation in its revised straw proposal comments (<http://www.aiso.com/Documents/DMMComments-EnergyStorage-DistributedEnergyResourcesPhase3-Jun252018.pdf>)

consumption or curtailment provided. The development of a typical usage adjustment will include both consumption and curtailment behavior of the PDR-LSR resource IDs:

- Established through a look back of both of the PDR-LSR resource IDs, the typical usage will take into account the consumption and curtailment values during non-event 15-minute intervals using a 10-in-10 non-event 15-minute selection method for similar days.
- The look-back period will extend to 45 days and calculate the simple average of the energy consumed or curtailed during the 10 most recent non-event 15-minutes for the same day type and for the same event interval when the PDR-LSR dispatch event occurred.¹⁹
- Two different day-types are recognized: Weekday (Monday through Friday), Weekend/Holiday (Saturday, Sunday, or NERC holiday).
- An event interval is one in which the PDR-LSR was subject to an Outage or previously provided Demand Response Services (other than capacity awarded for AS) in a given interval.
- A simple average will be limited to represent a typical usage for consumption/curtailment used to establish the point at which the resource is providing net load consumption.

The CAISO is proposing the following to develop a PDR-LSR typical usage:

1. LSR-curtailment (To account for load curtailment of energy storage): 10-in-10 customer load baseline, using 10 non-event hours including both consumption and curtailment in the calculation of the simple average, but only accept a value that is at or above 0 (positive generation = curtailment).
2. LSR-consumption (To account for load consumption of energy storage): 10-in-10 customer load baseline, using 10 non-event hours including both consumption and curtailment in the calculation of the simple average, but only accept a value that is at or below 0 (negative generation = consumption).

The PDR-LSR typical use value will be used to adjust the metered output, generation or load, when calculating its performance attributed to a curtailment or consumption dispatch. Changing the MGO methodology for energy storage participating under the

¹⁹ If the target number of intervals are not reached (Weekdays = 10 intervals; 5 intervals minimum) (Weekend = 4 intervals) the higher value of either the collected intervals or minimum number of intervals will be used. If the minimum number of intervals cannot be found, the value will be set to zero.

PDR-LSR is to account for a resource that is now responding to dispatches for consumption and curtailment. The CAISO believes the “typical use” of an energy storage resource as a PDR-LSR must consider movement in both directions. A participant that opts to provide load curtailment only with a directly metered energy storage device will continue to use the current MGO calculation under PDR, which only considers curtailment values in the 10 non-event hours.

Application of Performance Methodology

Currently, the DRP or SC calculates the performance of a facility’s load curtailment with the option through the FERC approved MGO methodology that recognizes a sub-metered storage device’s contribution to the facility’s overall load curtailment.²⁰ With the proposal of the PDR-LSR performance methodology, the DRP or SC of a PDR-LSR has the ability to calculate the load curtailment of the facility, load curtailment of the sub-metered storage device, and the load consumption from the sub-metered storage device. The following scenarios illustrate the various performance methodology configurations for a PDR with the inclusion of the proposed PDR-LSR methodologies.

1. **PDR** – A PDR resource that only offers load curtailment from the whole premise with no sub-metered devices. The PDR would calculate its performance methodology using a CAISO registered Customer Load Baseline (CLB)

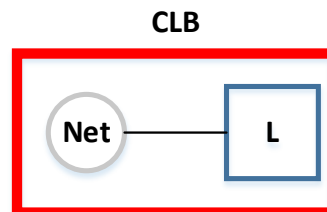

2. **PDR (sub-metered gen device ONLY)** – A PDR with a sub-metered energy storage device that only offers load curtailment. The facility load does not participate as a PDR which results in the sub-metered storage device utilizing the MGO methodology.²¹

²⁰ ESDER Phase 1 Draft Final Proposal describing MGO methodology, pg. 20-31
<http://www.caiso.com/Documents/RevisedDraftFinalProposal-EnergyStorageDistributedEnergyResources.pdf>

²¹ Note, the configuration does not allow for the independent participation of a sub-metered storage device if a facility does participate as a PDR.

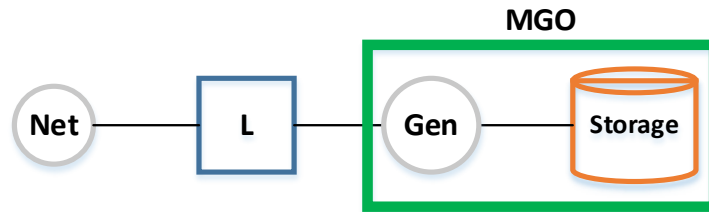

3. **PDR (sub-metered gen device)** – A PDR where the facility load and a sub-metered energy storage device offers load curtailment. Performance evaluation is separated by facility load curtailment and gen device load curtailment. The facility load nets out the sub-metered gen device and utilizes a CAISO registered CLB. The MGO methodology will then apply to the sub-metered gen device. Both values are combined to represent the total performance value of load curtailment provided.

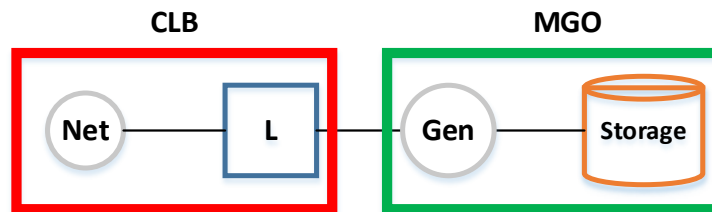

4. **PDR-LSR (sub-metered storage device only)** – A PDR-LSR where the facility load does not participate to provide load curtailment but only the sub-metered energy storage device provides load curtailment and consumption.²² The sub-metered storage device will utilize the proposed PDR-LSR methodologies for load consumption and curtailment.

²² See footnote 21

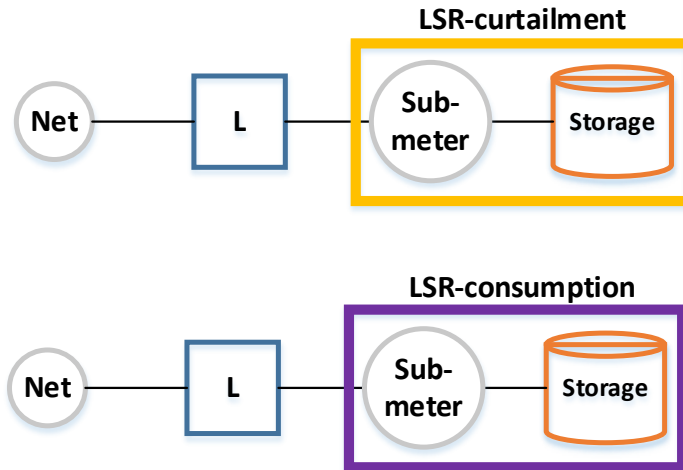

5. **PDR-LSR (Facility and sub-metered storage device)** – A PDR-LSR where the facility load is offering load curtailment and the sub-metered storage device is providing both load consumption and curtailment. The facility load nets out the sub-metered storage device and utilizes a CAISO registered CLB to calculate its load curtailment value. The sub-metered storage device will utilize the LSR-curtailment calculation to combine with the facility load CLB derived value. The LSR-consumption methodology will only apply to the sub-metered storage device. The CAISO has included a numerical example as an attachment to the Draft Final Proposal.

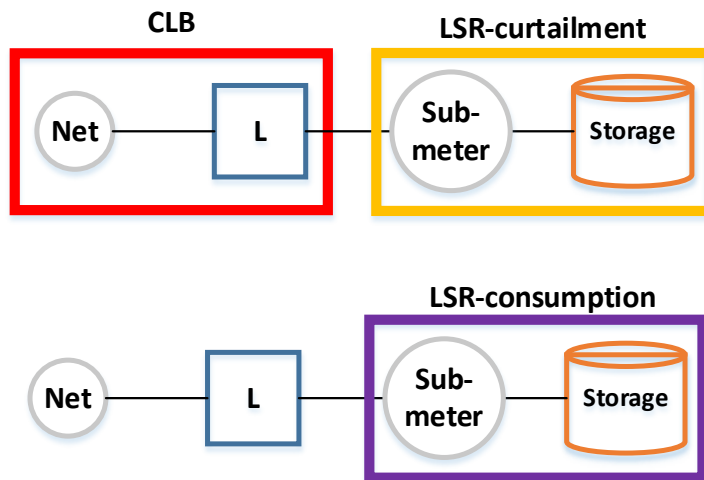

5.4 Recognition of behind the meter EVSE load curtailment

FERC approval of the CAISO ESDER 1 initiative tariff filing resulted in the implementation of the MGO performance measurement, which uniquely recognized a sub-metered

storage device's contribution to a facility's overall load curtailment during a CAISO dispatch event. As part of the ESDER 2 initiative process, comments received from certain stakeholders requested that the MGO concept extend to sub-metered EVSE loads. The design would allow for the recognition and measurement of an EVSE's load curtailment distinct from the facility's load.

5.4.1 Proposal

The CAISO proposes to enable EVSEs sub-metering and extend the MGO performance method for EVSE market participation independent of, or in combination with, its host customer. To be sure, EVSEs or any sub-metered device can already participate using the MGO provisions, but the CAISO currently cannot accommodate a sub-metered resource with a different performance methodology than its host facility load, which many desire for EVSEs. Sub-metering resolves the lack of fifteen-minute interval metering at the host facility for measurement of curtailment in five-minute intervals, enables direct measurement of the actual EV load curtailment achieved, and creates a more tailored market participation model for EVSEs.

Figure 8: CAISO's proposal to capture performance measurement of EVSE

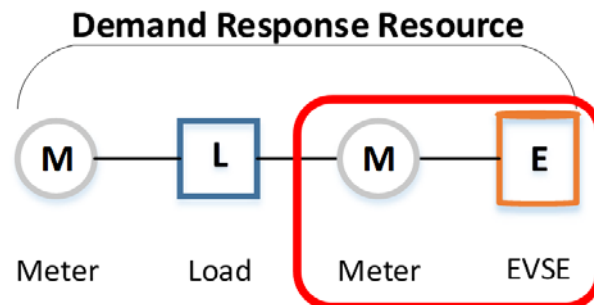

Pre-market

The CAISO proposes to differentiate between an “EVSE residential” designation and an “EVSE non-residential” designation in the DRRS.

1. EVSE residential – Will use a 5-in-10 customer load baseline
2. EVSE non-residential – Will use a 10-in-10 customer load baseline

The CAISO is proposing to support flexibility on metering configurations as long as it complies with the standards defined in the CAISO BPM for Metering, attachment G.²³

²³ CAISO BPM for Metering (<https://bpmcm.caiso.com/Pages/BPMDetails.aspx?BPM=Metering>)

The CAISO has illustrated in Figure 9 and Figure 10 the potential metering constructs for EVSEs.

Figure 9: Single sub-meter in front of aggregation of EVSEs

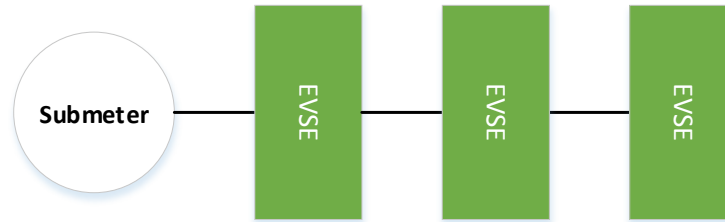
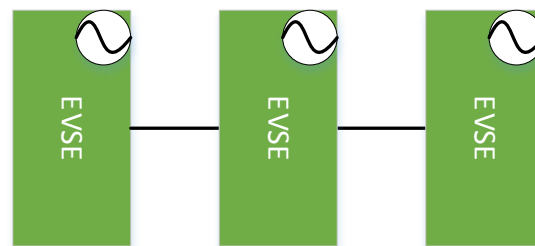

Figure 10: Individual meters embedded in EVSE



Market

The CAISO does not propose any changes to market systems because the proposal is only affecting the performance measurement of an EVSE.

Post-market

The CAISO proposes to apply similar principles of the MGO calculation to the EVSE measurement. The “EVSE residential” will utilize the 5-in-10 CLB methodology and the “EVSE non-residential” will utilize the 10-in-10 CLB methodology. Both CLBs will have a look back period of 45 days using either 5 or 10 of the most recent non-event hours. The demand response energy measurement (DREM) derived using the CLB will be in 5-min granularity with the option that if the sub-metered EVSE generates 15-minute interval data, the SC will transpose the data to three 5-minute intervals. Neither “EVSE residential” nor “EVSE non-residential” will have a load point adjustment (LPA) due to an EVSE’s performance not being weather dependent.

5.5 Multiple-Use Applications

Multiple-Use Applications (MUA) are when resources provide services to and receive compensation from more than one entity (e.g., the CAISO and a UDC) or in more than one domain (customer, distribution, transmission). BTM resources, DERs, and DER aggregations (DERAs) particularly seek to engage in MUAs in order to “stack” services

and revenue streams and thereby optimize their resource's value. Depending on the points of interconnection of the resources and the specific use-case, the resource may provide services to a combination of end-use customers, the distribution system, and the wholesale market and transmission system.

Since early 2016, the CAISO has supported the MUA policy development by collaborating with CPUC staff in its Energy Storage Proceeding Track 2 (R.15-03-011). CAISO and CPUC staff collaborated to produce a report, "Joint Workshop Report and Framework – Multiple-Use Applications for Energy Storage," which the CPUC issued on May 18, 2017 as part of an ALJ ruling seeking comments. The report was discussed at a CPUC workshop on June 2, 2017, followed by two rounds of public comments submitted in July 2017. The CPUC issued a ruling on January 11, 2018 that set forth principles for MUAs. The order also established subsequent working group meetings scheduled for 2018 to develop a final report to the CPUC commission by August 9, 2018 per D.18-03-011.

Since the decision, the CAISO has been actively participating in all working group meetings. At the time of the writing of this draft final proposal, the CAISO has yet to identify and develop a proposal within ESDER 3 that is needed to facilitate the implementation of the MUA framework. The CAISO will assess the adopted MUA rules and recommendations that emerge from the report against changes to tariff and/or market design that should be facilitated as part of a future CAISO initiative.

5.6 Non-Generator Resources

In its revised straw proposal, the CAISO provided an overview of issues that NGRs face while participating in the wholesale market. The revised straw proposal detailed the CAISO's understanding of stakeholders' issues and presented the CAISO's position on those issues. The CAISO will not be submitting any formal proposals to enhance the NGR participation model.

The CAISO understands the stakeholders and the various scenarios that battery storage resources be accommodated in the market. However, the CAISO is tasked with the difficult job of balancing system needs with the integration of fast ramping capabilities of battery storage. The CAISO agrees with stakeholders that an artificial "slower" ramp rate is not the right approach because it does not accurately represent the resource's capabilities. The CAISO agrees with PG&E that, "throughput cannot be perfectly

managed on a daily granularity, but can be managed over time.”²⁴ To go further, the CAISO believes that throughput limits can be expressed by scheduling coordinators through bidding parameters, as PG&E demonstrated with its battery storage resources.

The CAISO also has heard from stakeholders that battery storage resources should qualify as a use-limited resource to help manage excessive cycling. The CAISO understands that a manufacturing warranty may limit the number of battery storage cycles, but the CAISO has not been provided specific contract provisions that battery storage resources must adhere to and how those provisions may compare to current, actual use-limitations. The CAISO desires to explore this issue further with the storage community and is open to developing the process and qualifications for NGRs to qualify as a use-limited resource under the CAISO’s Commitment Cost Enhancements 3 (CCE3). Throughout the initiative, the CAISO requested that impacted stakeholders submit comments that provide potential use-limited qualifying factors and the types of documents a resource owner should provide to the CAISO to justify receiving use-limited status, but did not receive any comments.

To address the second issue on infeasible AGC signals as well as the regulation performance accuracy measurement being set too low, the CAISO staff is working with individual stakeholders to understand and resolve these issues. If a problem with the AGC signal surfaces based on affected stakeholder feedback and engagement, the CAISO would consider modifications to AGC and regulation performance in a separate initiative since such modification would have market wide implications. However, based on discussions and review of known customer issues to date, the CAISO found incorrect AGC signals were related to resources’ own programming errors.

The CAISO stresses the importance of actual data to help demonstrate both throughput and state of charge management issues. The CAISO requests that storage resource operators present data to the CAISO to help CAISO staff understand their specific issues and concerns. Such data and specific instances investigated will help the CAISO to determine if issues are isolated to operators, resources, or market design.

6 Future Considerations

The CAISO is aware of the growing number of energy storage and distributed energy resources and a future in which these resources will play an increasingly important role

²⁴ Slide 3 of PG&E’s Jan 16, 2018 presentation “What Are the Capabilities of the NGR and REM Market Models for Batteries?” <http://www.aiso.com/Documents/Presentation-AlvaSvobodaPG-E.pdf>

in the future grid. The CAISO will continue to work with stakeholders to identify enhancements to the integration of energy storage and DERs through its demand response and NGR participation models. As stated in stakeholder comments, as well as throughout the proposal, certain issues are still to be determined. The CAISO will continue to look at topics under DR, MUA, and NGR to determine if a future initiative is necessary.

Appendix A Acronyms

1. **AGC** – Automatic Generation Control
2. **BCR** – Bid Cost Recovery
3. **BPM** – Business Practice Manual
4. **BTM** – Behind The Meter
5. **CCA** – Community Choice Aggregation
6. **CCDEBE** – Commitment Cost Default Energy Bid Enhancements (policy initiative)
7. **CCE3** – Commitment Cost Enhancements Phase 3 (policy initiative)
8. **CLB** – Customer Load Baseline
9. **DAME** – Day-Ahead Market Enhancements (policy initiative)
10. **DERA** – Distributed Energy Resource Aggregation
11. **DLA** – Default Load Adjustment
12. **DLAP** – Default Load Aggregation Point
13. **DREM** – Demand Response Energy Measurement
14. **DRP** – Demand Response Provider
15. **DRRS** – Demand Response Registration System
16. **EVSE** – Electric Vehicle Supply Equipment
17. **FMM** – Fifteen-Minute Market
18. **IRP** – Imbalance Reserve Product
19. **LMP** – Locational Marginal Price
20. **LPA** – Load Point Adjustment
21. **LSE** – Load Serving Entity
22. **MEC** – Metered Energy Consumption (methodology)
23. **MGO** – Metered Generator Output (methodology)
24. **MOO** – Must Offer Obligation
25. **MUA** – Multiple-Use Application (CPUC Decision)
26. **NBT** – Net Benefits Test
27. **NGR** – Non-Generator Resource
28. **PDR** – Proxy Demand Resource
29. **PDR-LSR** – Proxy Demand Resource-Load Shift Resource
30. **RA** – Resource Adequacy
31. **RDRR** – Reliability Demand Response Resource
32. **RUC** – Residual Unit Commitment
33. **SC** – Scheduling Coordinator
34. **SIBR** – Software Infrastructure Business Rule (system)
35. **SOC** – State of Charge
36. **UIE** – Uninstructed Imbalance Energy

Attachment D – Board Memorandum

ESDER Phase 3B

California Independent System Operator Corporation

July 16, 2020



Memorandum

To: ISO Board of Governors

From: Keith Casey, Vice President, Market & Infrastructure Development

Date: August 29, 2018

Re: **Decision on the Energy Storage and Distributed Energy Resource phase 3 (ESDER 3) proposal**

This memorandum requires Board action.

EXECUTIVE SUMMARY

Management continues its efforts to lower barriers and enhance the ability of energy storage and distributed energy resources, including demand response, to participate in the ISO market through the energy storage and distributed energy resources phase 3 (ESDER 3) initiative. ESDER is an on-going stakeholder initiative to address market participation issues unique to demand response, non-generator resources, and distributed energy resource (DER) multi-use applications. This third phase of the initiative (ESDER 3) contains four elements requiring the Board of Governors' approval:

- 1) New bidding and real-time dispatch options for demand response
- 2) Removal of the single load serving entity aggregation requirement and the application of a default load adjustment
- 3) Load shift product for behind the meter energy storage
- 4) Performance evaluation methodology for behind the meter electric vehicle supply equipment load curtailment

The first element of the proposal provides demand response resources with additional bidding options to better align with certain resources' dispatch limitations. Stakeholders expressed concerns about the inability for certain demand response resources to respond to ISO dispatches in real-time due to insufficient notification time and recognition of their minimum run-time. To address these concerns, Management proposes to offer two new bidding options for proxy demand resources (PDR) that are modeled off the bidding rules applicable to inter-tie resources. Under the proposed bidding rules, PDRs will have the option to provide real-time market bids as an hourly block or as a 15-minute dispatchable

resource.¹ Choosing to be either an hourly block or 15-minute dispatchable resource provides PDRs with a longer dispatch notification time and a known minimum length of dispatch to respond to real-time dispatches.

The second element under the ESDER 3 proposal is a simplification of the registration rules and settlement mechanisms for aggregated demand response resources. The ISO currently requires demand response resource aggregations to be contained within a single load serving entity (LSE), represented by one demand response provider, and within a single sub-load aggregation point (sub-LAP).² The single LSE requirement stemmed from the ISO's application of a default load adjustment, which is a settlement mechanism to prevent a double payment for the load reduction of a demand response resource when it was provided during times found not to be net beneficial to the market. Stakeholders have expressed difficulty meeting or maintaining the minimum 100 kW threshold for demand response aggregations due to the migration of customers to new LSEs such as Community Choice Aggregators. Management proposes to remove the single LSE requirement for demand response aggregations, eliminate the need for a default load adjustment settlement mechanism, and institute a new bidding rule to ensure demand response resources bids are net beneficial to the system.

The third element of the proposal is a new product that will provide an opportunity for a behind the meter battery storage resources to consume energy during oversupply conditions and return that energy to the system during times of need. The new product, called the proxy demand resource – load shift resource (PDR-LSR), will enable such resources to bid and be dispatched for both load consumption (charging, negative generation) and load curtailment (discharging, generation) when the demand response resource is supported by a behind the meter battery storage device.

Finally, the fourth element of the proposal provides for separate load curtailment performance measurement of electric vehicle charge management through sub-metered electric vehicle supply equipment (EVSE). Stakeholders requested the ISO provide the means to recognize the distinct nature and performance of a sub-metered EVSE separate from the host facility's performance evaluation. Management proposes to leverage policy developed in ESDER 1, the metered generator output methodology, to develop a performance evaluation methodology for EVSEs.

Management proposes the following motion:

Moved, that the ISO Board of Governors approves the Energy Storage and Distributed Energy Resource phase 3 proposal, as described in the memorandum dated August 29, 2018; and

¹ PDRs will still have the ability to respond to 5-minute real-time dispatches as they do today if those PDRs prefer to stay with existing bidding and dispatch rules and not elect to participate under these new bidding options.

² A sub-LAP is a sub-region of pricing nodes grouped by similar grid conditions within a default load aggregation point.

Moved, that the ISO Board of Governors authorizes Management to make all necessary and appropriate filings with the Federal Energy Regulatory Commission to implement the proposal, including any filings that implement the overarching initiative policy but contain discrete revisions to incorporate Commission guidance in any initial ruling on the proposed tariff amendment.

DISCUSSION AND ANALYSIS

1) New bidding and real-time dispatch options for demand response

Management has recognized and worked towards resolving potential infeasible dispatch issues resulting from how the ISO's market optimization manages a demand response resource with a minimum operating level (Pmin) of 0 MW. Today, the ISO's market systems will issue a start-up instruction to a demand response resource to their Pmin, often 0 MW, well in advance of the commitment hour in the real-time market. This commitment ensures both start-up and minimum runtime constraints are met. Once these constraints are met, the optimization sees the resource as available for dispatch whenever the resource's energy bid is economic. This can result in 5-minute dispatch instructions with only a 2.5-minute notification time. Certain affected stakeholders have explained that this notification time is infeasible for many PDRs. In response, Management proposes to offer bidding options for PDRs that will provide longer notification times and extended real-time dispatch intervals, similar to what the ISO currently offers to inertia resources.

The two additional bidding options are:

Hourly block – The scheduling coordinator submits an hourly real-time market bid 75 minutes prior to the operating hour. If determined to be economic over the hour, the resource will be scheduled via the hour ahead scheduling process but will be settled at 15-minute market prices over the operating hour. The binding schedule is communicated to the scheduling coordinator at 52.5 minutes before the flow of energy. Because the resource is scheduled for the full hour, it will settle at the 15-minute market in real time making it a “price-taker” for the full hour.

15-minute dispatchable – The scheduling coordinator (SC) submits an hourly real-time market bid 75 minutes prior to the operating hour. If the 15-minute bid is economic, it will be dispatched and receive a binding schedule at the 15-minute market price. The dispatch notification is communicated 22.5 minutes before the flow of energy is expected.

Management believes that providing PDRs with the hourly and 15-minute economic bidding options currently available to inertia resources will allow certain PDRs that cannot respond to 5-minute dispatches to viably participate in the real-time market and increase resource performance. The new bidding options will also provide opportunities for participation from new demand response resources that were previously unable to align their resource performance with the current real-time bidding requirements.

2) Removal of the single load serving entity aggregation requirement and the application of a default load adjustment.

The ISO currently requires demand response resource aggregations be contained within a single load-serving entity (LSE), represented by one demand response provider, and within a single sub-LAP. The ISO originally established the single LSE requirement in its PDR policy, later replicated in the reliability demand response resource (RDRR) policy, to facilitate the settlement application of an LSE-specific default load adjustment. The default load adjustment mechanism eliminates a double payment for a demand response resource when it is not net beneficial to all energy purchasers in terms of a wholesale market price reduction based on the demand response net benefits test, which was a test instituted by the Federal Energy Regulatory Commission.³ The double payment occurs when the LSE gets credit for the load that does not show up in real-time in addition to the payment to the demand response provider. This double payment was determined by FERC to not be beneficial to the market if the demand response is dispatched at a bid price that does not have a significant impact on market clearing prices. At higher bid levels, demand response resources can have a greater impact on market clearing prices due to the shape of the resource supply curve. FERC defined that level at which demand response bids become net beneficial to the market, without the need for the default load adjustment, as the net benefits test threshold price.

The default load adjustment design feature required segmenting a demand response program into different aggregations by LSEs within a single sub-LAP. Demand response market participants raised concerns that this segmentation could potentially strand willing customer participants and affect the ability for some aggregators to meet the minimum market participation size requirement of 100 kW. In more specific cases, demand response providers establishing new resource aggregations expressed difficulty meeting, or maintaining, the 100 kW minimum participation requirement as customers are defaulted or moved to new LSEs, such as to a Community Choice Aggregator (CCA). Therefore, Management proposes to remove the single LSE requirement for demand response aggregations as well as remove the application of the default load adjustment settlement mechanism and institute a bidding rule that requires proxy demand resources bid at or above the net benefits test price threshold.

Management believes removing the default load adjustment settlement mechanism is necessary because the allocation of costs becomes too complex to implement and manage across multiple LSEs under a single demand response aggregation. In support of removing the default load adjustment, data analysis shows that the settlement implications have historically been de minimis relative to the benefits achieved by eliminating the one LSE per demand response aggregation requirement. To ensure that demand response resources are bidding beneficially to the market, Management proposes to utilize the net benefits test threshold price to screen submitted demand response bids to ensure they are at or above

3

<http://www.caiso.com/informed/Pages/StakeholderProcesses/CompletedClosedStakeholderInitiatives/DemandResponseNetBenefitsTest.aspx>

the threshold price in compliance with FERC Order No. 745. The bidding requirement will ensure demand response resources are net beneficial to the system when submitting bids to the ISO rather than an after-the-fact assessment in the settlement system currently conducted through the default load adjustment. The ISO will use the existing monthly calculation of the net benefits test and its resulting on-peak and off-peak threshold prices to validate bid submissions in the day-ahead and real-time markets to ensure all energy bids from proxy demand resources are at or above the net benefits threshold price.

3) Load shift product for behind the meter energy storage

Management proposes to develop a load shift product for behind the meter storage devices under the PDR demand response participation model. The load shift product will fall under existing PDR policy provisions with new functionalities to enable the resource to bid and be dispatched for both load consumption (charging, negative generation) and load curtailment (discharging, generation) from a behind the meter battery storage resource. The initial product will allow a PDR to access day-ahead and real-time energy markets for both load curtailment and load consumption through the use of two separate resource IDs. The proposal will facilitate the provision of “shift” services while maintaining a demand response policy that injection or export of behind the meter energy storage beyond the retail meter is not eligible for wholesale market compensation, nor is energy associated with typical use for non-ISO purposes, such as customer demand and energy management.

The PDR-LSR will be designed as two discrete resource IDs utilizing specific bidding rules and parameters to prevent scenarios where both resource IDs are given conflicting dispatches. The resource ID for curtailment (discharging, generation) will be allowed to bid from the net benefits test price up to the ISO bid cap and the resource ID for consumption (charging, negative generation) will be allowed to bid from less than \$0 down to the bid floor (currently at -\$150). In addition to specific bidding rules, the resource ID for curtailment must register with a Pmin of 0 MW and the ISO will enforce ramping capabilities for each resource ID.

The PDR-LSR will be settled using the meter on the storage device, subtracting off any typical use (i.e., for non-ISO purposes) such as customer energy and demand management. This subtraction of typical use ensures the ISO is not compensating for services provided for other purposes, under a multiple use application. The typical use is calculated using a 10-in-10 customer load baseline methodology. The 10-in-10 methodology estimates what electricity use would typically have been during the relevant settlement intervals but for an ISO dispatch instruction. The subtraction of typical use is an existing and FERC-approved settlement construct that is applied today to proxy demand resources that elect the meter generator output performance evaluation methodology. Specific to PDR-LSRs, Management proposes to modify the existing 10-in-10 “typical use” baseline methodology to account for both charge and discharge values when establishing the typical use value. Specifically, when the simple average of typical energy use is opposite to the ISO dispatch, the value is adjusted to zero. In other words, if the device is typically charging when the ISO

instructs the resource to discharge, the ISO will set the typical use to zero, expecting energy to be delivered equal to the ISO dispatch instruction.

4) Performance evaluation methodology for behind the meter electric vehicle supply equipment load curtailment

In ESDER phase 1, Management proposed the meter generator output (MGO) performance measurement, which uniquely recognizes a sub-metered storage device's contribution to a facility's overall load curtailment during an ISO dispatch event. Certain stakeholders requested that the ISO extend the MGO concept to sub-metered electric vehicle service equipment (EVSE) load curtailment.

Management proposes to enable EVSE sub-metering and extend the MGO performance method for EVSE market participation independent of, or in combination with, its host customer. Currently, EVSEs or any sub-metered device can already participate using the MGO provisions, but the ISO currently cannot accommodate a sub-metered resource with a different performance evaluation methodology than its host facility load, which many desire for EVSEs. Sub-metering resolves many issues including the lack of fifteen-minute interval metering at the host facility for measurement of curtailment in five-minute intervals, enabling direct measurement of the actual EV load curtailment achieved, and creating a more tailored market participation model for EVSEs. The proposal includes implementing two additional day-matching customer load baselines to accommodate for EVSEs in the residential and non-residential sector.

POSITIONS OF THE PARTIES

Stakeholder comments were generally supportive of ESDER 3's proposal with the exception of one stakeholder opposing the EVSE element of the proposal.

Under the proposal for a load shift product for behind the meter energy storage, a majority of stakeholders support the calculation of a typical use as an important and reasonable settlement construct. One stakeholder, Stem, representing storage resource interests, does not support the proposed treatment of typical use under the PDR-LSR option.

Stem believes that if their storage device is typically charging when the ISO dispatches the device to discharge, then it should be credited for its typical use. In other words, if the ISO dispatched Stem's storage device to discharge 25 kW, and the typical use calculation shows the device typically charges at 25 kW of energy in this same interval, then Stem should have no obligation to deliver actual energy; they simply must stop charging the battery to fulfill the ISO's dispatch instruction.

Stem's proposal is problematic for several reasons. Currently, there is a fundamental misalignment between retail rates and the needs of the bulk grid, which creates perverse

incentives and outcomes that are not rational from an overall system perspective. Most LSE retail time of use (TOU) rates continue to identify 12 noon to 6 PM as a peak period, meaning customers are incented to conserve during periods of over supply when the bulk system needs consumption. Retail partial peak periods occur after 6 PM, just when the ISO is experiencing the net peak demand, i.e. from 4 PM to 9 PM. From 4 PM to 9 PM, the ISO generally needs conservation and wants storage devices to discharge. The PDR-LSR option is designed to help the ISO address over-supply and store negatively priced energy during over-supply conditions, and preferably, deliver that energy back to the system in times of need. Unfortunately, current TOU rates provide storage a very strong retail incentive to do the opposite of the what the bulk power system needs — to discharge the storage device to manage a customer's peak demand during peak solar output periods (belly of the duck) and to charge during the evening net load ramp period when solar output tails off and loads continue to be high (neck of the duck) — the opposite of what is needed for reliability. The misalignment of retail TOU rate periods and ISO bulk system needs creates opportunities where it is both advantageous to charge and at the same time be paid by the ISO to stop charging, since the charging exacerbates the net load ramp in the first instance. This is a perverse incentive that should not be supported as an ISO performance evaluation method. To address this, Management's proposal sets any typical consumption of a PDR-LSR to zero when settling the battery for its discharged energy. This prevents the gaming opportunity described above, and ensures actual energy is delivered in response to an ISO dispatch instruction.

Second, Stem argues this is discriminatory treatment of PDR-LSRs since traditional demand response is credited for its typical use. However, behind the meter energy storage device is different from traditional demand response because it is able to shift and store energy dynamically. Traditional demand response must curtail load, i.e., it must turn off actual load in response to an ISO dispatch instruction, thus reducing production, service, or comfort in exchange for a wholesale payment. In other words, traditional demand response cannot sit idle in response to a dispatch instruction and get credit for its typical use. Services must be curtailed and actions must be taken to intentionally reduce load below the customer's typical use baseline.

Third, the incentives for storage to charge when the system needs it to discharge, and vice versa will be mitigated when retail rates and the needs of the bulk power system are more closely aligned. With retail rate alignment, there should be limited instances and incentives for a battery's typical use to be in the opposite direction of the bulk power system's needs. Therefore, Management's typical use baseline applied to the proposed PDR-LSR option is appropriate and helps prevent these gaming opportunities under the current retail rate construct.

Management's concerns and justifications in response to Stem's position is generally supported by stakeholders and by the Department of Market monitoring.

Under the proposal for a performance evaluation methodology for a sub-metered EVSE, a majority of stakeholders have given general support for the proposal with the exception of

Southern California Edison (SCE). SCE opposes the proposal based on its concerns with a potential scenario where an EVSE participating in the wholesale market would not provide a full load drop because it could potentially disconnect from one EVSE and, in turn, connect to a non-participating EVSE. Management believes that the scenario posed by SCE is a highly unlikely scenario based on several discussions with stakeholders throughout the process. Management does not believe that there is an economic incentive nor a technologically feasible implementation for an EVSE owner to switch electric vehicles to non-participating EVSEs in response to ISO market dispatches. Pacific Gas & Electric requested as a condition to supporting Management's proposal, an attestation be required for EVSE participants when registering and submitting its ISO settlement quality meter data plan that they will provide curtailments of the EVSE consistent with their dispatch. Management has included this requirement in its proposal to disincentivize the practice of not providing full load curtailment by PDRs electing to register under the EVSE option.

Management addresses additional stakeholder comments in Attachment A.

CONCLUSION

Management requests the Board approve its proposal for the provision of two new bidding options for PDRs, eliminating the single LSE requirement and DLA settlement mechanism, the load shift product for behind the meter energy storage devices, and establishing performance evaluation methodologies to recognize an EVSE's load curtailment distinct from its host facility. The proposed enhancements will provide energy storage resources and distributed energy resources more opportunities to efficiently participate in the ISO market.