



Straw Proposal

Post-Release 1 MRTU Functionality for Demand Response

Executive Summary

The California Independent System Operator (CAISO) has a goal of helping to develop demand response resources that add to California's electric capacity and can participate in the CAISO's markets. The purpose of this document is to convey how the CAISO intends to enhance the functionality for demand resources that is in the initial release (Release 1) of its Market Redesign and Technology Upgrade (MRTU) program so that demand resources can more fully integrate and participate in the CAISO's markets and grid operations. This document is part of a stakeholder process that will specify the core set of software requirements that will be implemented in the CAISO's next phase of demand response. Once these are set, the Working Group will proceed to develop the procedures and User Guide for implementation of this Post-Release 1 approach.

This Straw Proposal provides details about the enhanced functionality to be implemented Post Release 1 under MRTU. The functionality described herein effectively provides demand resources with full comparable functionality to that of a generator in the CAISO's market software and systems. This proposed design provides considerable flexibility for demand resources, allowing Participating Loads to (1) simply bid into the CAISO Markets with a forward Energy Bid, or (2) provide additional details about the operating characteristics of the demand resource like Minimum Load Reduction (minimum MW of demand response), Minimum and Maximum Load Reduction Time, and Minimum Load Reduction Cost in addition to the Energy Bid, or (3) provide capacity for Residual Unit Commitment (RUC) and/or as Non-Spinning Reserve or other Ancillary Services (AS). In addition to providing additional options to market participants, having additional resources participating in the CAISO Markets makes the markets more liquid and addresses market power concerns, and having resources bid at their locations instead of at the Default Load Aggregation Point improves enhances congestion management.

The guiding principle for this Straw Proposal, which is that the Participating Load model should provide flexibility, means that at the most basic level, the minimum participation for Participating Load requires submitting only a simple Energy Bid. This provides a way of "participating" in the CAISO's market without requiring more complex resource parameters. Yet the model does appropriately provide additional options within the same program design when Participating Loads have need for additional functionality and resource modeling capability. A Participating Load that simply submits an Energy Bid is not very different from Price-Responsive Demand that bids as non-Participating Load, and both are valuable resources in the CAISO Markets. A Participating Load can bid into the Real-Time Market as well as the Day-Ahead Market, receive local LMP prices as compensation for Demand reductions when local areas are more congested than larger areas of the transmission system, and can set the Real-Time market price. Using additional, optional Bid components, a Participating Load can choose to provide capacity for

California Independent System Operator

RUC or AS, or to inform the CAISO that it has operational limits including but not limited to Minimum Load Reduction and associated costs, Minimum and Maximum Load Reduction Times, minimum time between load reductions, Minimum and Maximum Daily Energy Limits, and maximum number of daily load curtailments. The CAISO's design accommodates both customers with hourly and sub-hourly metering intervals. Telemetry is required only if a Participating Load provides AS.

This document updates a Draft Straw Proposal that the CAISO published (<http://www.caiso.com/1c64/1c64d4d07e40.pdf>) on September 25, 2007, and a Revised Draft Straw Proposal that the CAISO distributed to demand response working group participants on October 25, 2007, based on written comments on those documents from working group participants and discussion at working group meetings on October 16 and November 5, 2007. To the extent that working group participants' suggested enhancements to the CAISO's initial Draft Straw Proposal can be accommodated within the overall MRTU design and within the CAISO's obligations as a Control Area operator, the CAISO has incorporated them in this Straw Proposal. The CAISO has used the discussion in the demand response working group to add to the stakeholder process that began with discussion of an Issue Paper at a stakeholder meeting on June 26, 2007. In the CAISO's typical stakeholder process, the next step would have been publication of a Straw Proposal, which is this document. The CAISO believes that the added discussion in the demand response working group has resulted in a more thorough consideration of stakeholder concerns than would have occurred if this Straw Proposal had been produced directly after the Issue Paper. After discussion of this Straw Proposal with stakeholders as a whole, the CAISO will continue to use its stakeholder and working group processes in parallel to actively involve stakeholders in the informal working group setting to develop tariff provisions, updates to Business Practice Manuals, and develop a User Guide, and then bring the results to stakeholders as a whole at the same intervals that would normally occur.

Introduction

The CAISO's market design prior to MRTU includes opportunities for Loads to participate in the CAISO's Real-Time (RT) Energy market, and to provide Non-Spinning Reserve – known as Participating Loads. Through MRTU and subsequent market enhancements, the CAISO seeks not only to preserve these existing options, but also to add to their functionality. The September 21, 2006, FERC Order on MRTU, as well as FERC Orders since then, directed the CAISO to work with market participants to present additional opportunities for Demand Response resources to participate in the CAISO Markets.

The CAISO MRTU Release 1 software will include limited functionality but will allow demand resources to participate directly in the CAISO wholesale markets. The CAISO markets for MRTU Release 1 will accommodate pumping by aggregated water pumps and pumped storage hydroelectric generators, which participate in the CAISO markets as Participating Loads. Although the MRTU Release 1 design is limited, it may be possible for other types of demand resources to fit into this model, allowing other non-pumping demand resources to provide Imbalance Energy as well as Non-Spinning Reserve. This Straw Proposal proposes market design enhancements that significantly expand the options available to Participating Loads under MRTU Release 1.

In response to the FERC Orders and keen interest expressed by the California Public Utilities Commission (CPUC) and California Energy Commission (CEC) in developing and integrating demand resources into the wholesale markets, five key demand resource working groups have been formed to help meet this important objective. The five working groups are:

California Independent System Operator

1. Demand Response Participation in MRTU Release 1 (Lead agency - CAISO)
2. Demand Response Participation in MRTU Post Release 1 (Lead agency - CAISO)¹
3. Demand Resource Product Specification (Lead agency - CEC)
4. Infrastructure for Demand Resources (Lead agency - CEC)
5. Vision for Demand Resources (Lead agency - CPUC)

Each working group has specific objectives and resulting deliverables to produce, with the overarching objective being to enable greater participation from demand resources in the wholesale electricity markets.

This Straw Proposal is the result of a collaborative effort by the Demand Response Participation in MRTU Post Release 1 Working Group (group 2). As a product of the Post Release 1 working group, the scope of this document is to develop details for the implementation of enhanced Participating Load functionality in Release 1A, and is not intended to be a comprehensive vision statement for demand response in broader California contexts. This Straw Proposal adds functionality to what is available in MRTU Release 1, and does not replace MRTU Release 1's functionality for non-Participating Load. (The relationship to MRTU Release 1's functionality is described later in this Straw Proposal.)

Following this phase of the working group's activity, this Straw Proposal will be discussed with the broader community of stakeholders, and will then be a key input into the CAISO's software development process. The working group will also continue its activity by providing input into the CAISO's Business Practice Manuals and a User Guide for Participating Loads.

The CAISO initiated this working group by publishing an Issue Paper on "Post-Release 1 MRTU Functionality for Demand Response" on June 26, 2007 (see <http://www.caiso.com/1c08/1c0810a2e527b0.pdf>), and presenting it for discussion at a MRTU Release 1 demand response working group meeting on that date. The CAISO's Issue Paper described the vision for Participating Load functionality as originally stated in the CAISO's Market Design 2002 ("MD02") filings, but that original vision could not be realized until after the initial implementation of Market Redesign and Technology Upgrade ("MRTU"). The reader is encouraged to review the Issue Paper for the background that it provides. Feedback from stakeholders at that meeting indicated that there is interest in proceeding to develop the Participating Load functionality following the concepts that were described. Consequently, the CAISO has documented its proposed functionality in this Revised Draft Straw Proposal, including an appendix titled "Development of Software Requirements for Participating Load (Post-Release 1)". The CAISO's intent is that the final version of this appendix will become part of the Software Requirements Specification that guides the implementation of the Participating Load functionality.

Background

The original MD02 conceptual design included a comprehensive Participating Load model, which included voluntary three-part bids similar to generators' start-up/ minimum-load cost/ multi-segment Energy Bid, RUC participation, Load aggregation, participation in multiple markets (Day-Ahead (DA) and RT), eligibility to provide Non-Spinning Reserve, run-time constraints, etc. The original Participating Load design contemplated scheduling at local or aggregated levels, however, the overall MRTU design changed to scheduling Load at highly aggregated levels, which created a challenge since the Dispatch of Participating Load is needed at specific physical locations in the CAISO's transmission network. A market power concern

¹ The scope that has been outlined for Working Group 2 is: "Determine how demand resources will be modeled and fully integrated into the wholesale electricity markets and CAISO grid operations. This could involve changes to the MRTU software and tariff."

California Independent System Operator

was raised regarding the originally proposed Participating Load design: if the two principles of (1) overall scheduling of Load at a highly aggregated levels and (2) dispatching at specific physical locations were simply combined in a way that would first schedule Load at a highly aggregated level and then re-dispatch it at its specific physical location, an opportunity for abusing the market design would be created through scheduling of fictitious Load that is then “curtailed” at a higher price, back to its actual level.² This difference meant that the full Participating Load model could not be adapted in time for implementation in MRTU Release 1, and interim solutions needed to be implemented in MRTU Release 1, as described in the June 26 Issue Paper. However, the original Participating Load model was partially developed during MRTU Release 1’s implementation, and it appears that it can be restored as a market enhancement after Release 1.

The scope of this document does not include the functionality for pumped storage hydro generation, which is already addressed in MRTU Release 1. Release 1A will not decrease, and may improve, the Release 1 functionality for pumped storage hydro generation, but such changes are beyond the scope of this document.

Principles for Participating Load Functionality

A guiding principle for this Straw Proposal is that as a full dispatchable demand resource model, the Participating Load model should provide flexibility. This it does since, at the most basic level, minimum participation for Participating Load means only a simple Energy Bid must be submitted. The ability to provide only a simple Energy Bid can be considered as “Participating Load Lite” if you will, i.e., a way of “participating” in the CAISO’s market without requiring more complex resource parameters to be submitted along with the energy bid. Yet the model does appropriately provide additional options within the same program design when Participating Loads have need for additional functionality and resource modeling capability. A Participating Load that simply submits an Energy Bid is not very different from non-Participating Load, and both are valuable resources in the CAISO Markets. Using additional, optional Bid components, a Participating Load can choose to participate more flexibly in the CAISO Markets, to the benefit of both the CAISO and the Participating Load. The following discussion outlines several levels of participation that are available to Participating Load in the CAISO Markets.

Price-Responsive Demand

Despite its name, a non-Participating Load can participate in the CAISO markets by submitting an hourly Energy Bid in the CAISO’s Day-Ahead Market (DAM) and, most likely, purchasing or selling Energy in the Real-Time Market (RTM) by having actual Demand that differs from its DA Schedule.³ The use of an hourly DA Energy Bid, and the opportunity to adjust Demand in RT based on the market price of Energy, constitute Price-Responsive Demand.⁴ The DA Energy Bid for Price-Responsive Demand may have up to 10 segments, but a Bid may include fewer

² The potential for abusing the market design, and the resulting requirements for its mitigation, were discussed in a working group meeting on October 16, 2007. See <http://www.caiso.com/1c79/1c799d9a40d50.pdf>.

³ As an alternative to submitting an Energy Bid that indicates a price that the Load is willing to pay in the Day-Ahead Market, the Load can be “self-scheduled” by submitting only a MW quantity. However, a Self-Schedule is a “price taker” and is not price-responsive from the CAISO market perspective.

⁴ Other terms that use capitalization (e.g., Participating Load), the term is capitalized because it has the meaning stated in Appendix A of the MRTU tariff. For purposes of this document, “Price-Responsive Demand” is capitalized to emphasize that it has an equally important role in the CAISO Markets. Generally, “Price-Responsive Demand” is used to describe Demand that responds to varying prices in DA or RT, which is not necessarily a Participating Load.

California Independent System Operator

segments. The Price-Responsive Demand can indicate in its Energy Bid the price that it is willing to pay for the specified quantities of Energy in the DAM. The geographic areas that are covered by DA Energy Bids by non-Participating Load (including Price-Responsive Demand that is not Participating Load) are three large Load Aggregation Points (Default LAPs), where the same price applies to all locations within the Default LAPs.⁵

Figure A presents an example of an Energy Bid in the DAM for Price-Responsive Demand. In this example, there is a minimum amount of Demand that is labeled “Minimum Load”, which is a “price taker”, i.e., the bidder is willing to pay any market clearing price for this amount of Energy, regardless of how high the price is.⁶ There are then multiple Bid segments that indicate amounts of Energy that would be purchased at various prices, which extend out to a “Maximum Load”, which represents the most Energy that this bidder would purchase at any price, regardless of how low the price is. There is no requirement that the prices of the Energy Bid segments must be greater or less than an expected market clearing price: that is, an Energy Bid segment could either indicate a limited willingness to buy Energy if it costs more than a certain amount, or an interest in buying inexpensive Energy if it is available.

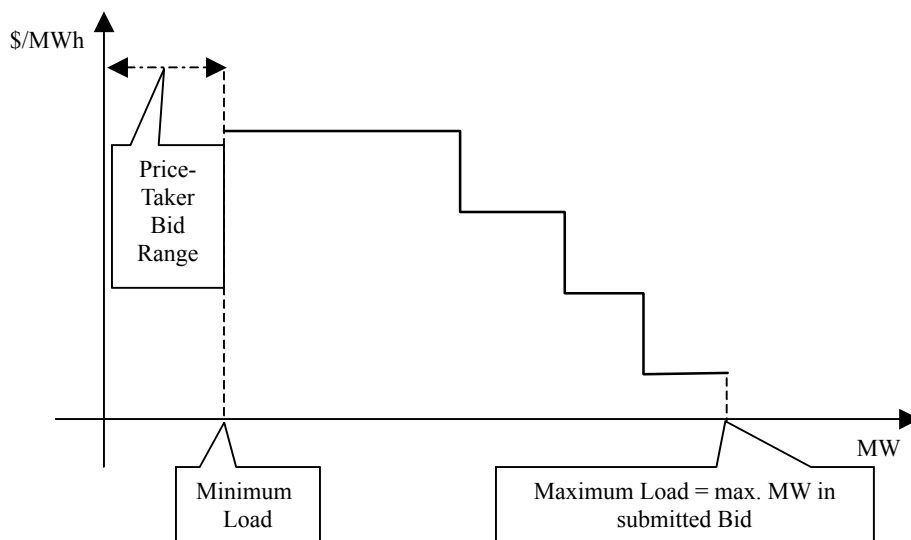

Figure A: Day-Ahead Energy Bid for Price-Responsive Demand

In RTM, the CAISO must dispatch enough “Supply” to match the actual Demand, and therefore non-Participating Load, by its very definition, is not dispatchable by the CAISO. Thus, non-Participating Load is ineligible to submit RT Energy Bids and participate in the RTM. However, under MRTU, the CAISO will publish the current RT cost of Energy (which is the market clearing price for market dispatches issued at the start of a Dispatch Interval, for Energy needed during

⁵ The three Default LAPs are the Pacific Gas and Electric, Southern California Edison, and San Diego Gas and Electric transmission areas.

⁶ Any Demand that is scheduled using Transmission Ownership Right (TOR) or Existing Transmission Contract (ETC) capacity must be scheduled as a price taker at a MW level no higher than the Minimum Load. Price-Responsive Demand cannot be self-scheduled using a TOR or ETC scheduling priority, because the use of these scheduling priorities inherently excludes the capacity covered by an economic Energy Bid. This applies to Participating Load as well as to non-Participating Load.

California Independent System Operator

the Dispatch Interval), in addition to advisory prices 45 minutes before the beginning of each hour, for each 15-minute interval within the hour.⁷ This will allow Price-Responsive Demand to adjust its level of consumption to either avoid paying for avoidable usage during high-cost intervals, or purchase additional Energy during low-cost intervals. The CAISO discussed the availability and use of the RTM's advisory prices in the demand response working group meeting of July 17, 2007. The CAISO's presentation is available at <http://www.caiso.com/1c27/1c27755a43710.pdf>.

There are no penalties in Release 1A of the CAISO Markets that limit the ability of Price-Responsive Demand to select its level of consumption in the DAM or to adjust its consumption in the RTM: (1) whereas section 11.23 of the MRTU tariff provides Uninstructed Deviation Penalties that may be imposed, subject to additional FERC Order, on generators and Interchange transactions with other Control Areas, these provisions do not apply to Load or Curtailable Demand, and (2) provisions that are currently being developed for MRTU Release 1 to ensure sufficient DA scheduling of Load terminate with the implementation of Convergence Bidding in Release 1A, which is when the Participating Load functionality described in this document is also implemented.

Because location-specific information is not provided in Bids for non-Participating Load, Price-Responsive Demand that is non-Participating Load cannot bid to provide AS or capacity for RUC. Instead, the CAISO has been working through the MRTU Release 1 working group to establish a mechanism for Load Serving Entities to inform the CAISO about their operation of demand response programs that use non-Participating Load (whether price-responsive or not), and for the CAISO to use this information to adjust its capacity procurement in the RUC process. The mechanisms developed for MRTU Release 1 can remain available for as long as Load Serving Entities operate demand response programs that use non-Participating Load.

Participating Load: Basic Functionality

Like other Price-Responsive Demand, the Energy Bid for a Participating Load may have up to 10 segments, but a Bid may include fewer segments. The Energy Bid is the only required Bid component for a Participating Load. Figure B presents an example of an Energy Bid for Participating Load. As the reader will note, Figure B is nearly indistinguishable from Figure A – that is, there are few differences between the minimum participation of a Participating Load and the activity of Price-Responsive Demand that is in the CAISO Markets as a non-Participating Load.⁸

⁷ The RTM's Hour-Ahead Scheduling Process (HASP) determines binding hourly Schedules and prices for Intertie resources that cannot participate in RT interval dispatch, and also publishes the dispatch and prices within the CAISO Control Area that result from HASP, which are non-binding for Non-Participating Loads or for resources that dispatchable in RT interval dispatch.

⁸ The CAISO's Participating Load software functionality for Release 1A will need to assume that in the market optimization, there is a single Energy Bid that includes both the initial scheduling of Energy and the demand response that may modify that Energy Schedule. However, the policy that affects how Bids are submitted to the CAISO may change to allow a demand response aggregator that is a separate Market Participant from the Load Serving Entity (LSE), if CPUC regulations allow this to occur. The CAISO will specify that its vendor's software design should not assume that the demand response aggregator is the same entity as the LSE, but more details will be needed before these market roles can be separated. First, retail market rules would need to be established such as whether the demand response aggregator and the LSE need to be aware of the other's Bids and Schedules, how Imbalance Energy would be allocated between them, etc. Then the CAISO would need to define rules to maintain reliability and accurate settlements, such as the LSE needing to schedule the same Custom LAP as the demand response aggregator, avoiding double-counting that could occur if the LSE's Scheduling

California Independent System Operator

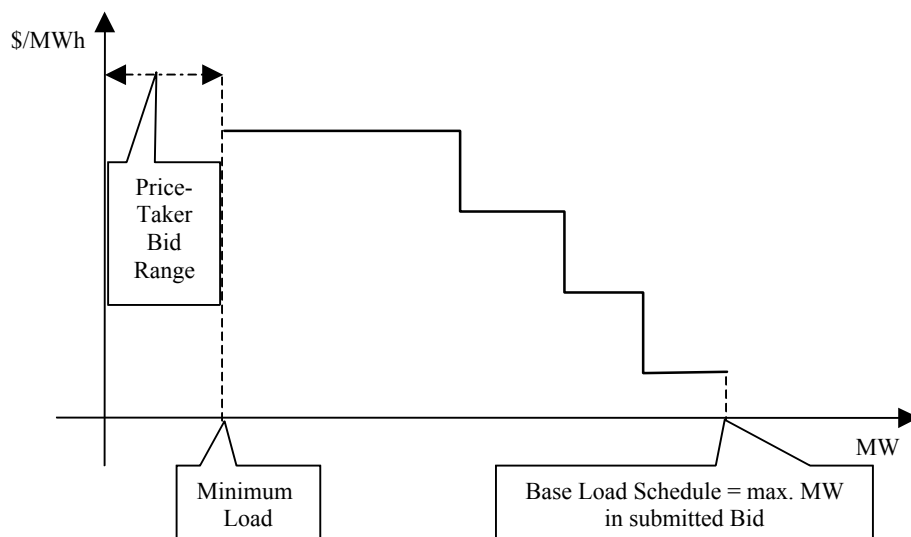

Figure B: Day-Ahead or Real-Time Energy Bid for Participating Load

The differences between the Energy Bids presented in Figures A and B are:

1. Bids that have been submitted in the DAM may be revised in the RTM, for scheduling in either the Hour-Ahead Scheduling Process⁹ or RT interval dispatch (depending primarily on the capability of the end-use customer's meter).¹⁰
2. As indicated in the June 26 Issue Paper, Participating Loads will schedule at a nodal level or using custom load aggregation points (Custom LAPs), generally within boundaries such as the "sub-LAPs" used in parts of the current Congestion Revenue Right allocation process.¹¹ This level of aggregation ensures that the CAISO can rely on

Coordinator schedules its demand based on the same reduction that the demand response aggregator is bidding, defining responsibility for Uninstructed Deviations in the wholesale market, etc.

⁹ This Revised Draft Straw Proposal adds an option to the design in the September 25 Draft Straw Proposal to recognize that some retail meters only support hourly metering intervals, by dispatching these Participating Loads in the Hour-Ahead Scheduling Process (HASP), similar to Intertie resources. Dispatch in HASP has some limitations because HASP has a limited look-ahead period for its market optimization, and because Real-Time Bids are only available hour-by-hour. Multi-hour dispatch commitments are not possible in HASP, other than unit commitment of medium-startup-time generation (which generally has a minimum load that is a small fraction of its maximum capacity). For Participating Loads that cannot participate in Real-Time interval dispatch and have minimum curtailment periods, minimum operating time limits will be available in the Day-Ahead Market. This Revised Draft Straw Proposal does include limitations on availability for dispatch, as opposed to minimum duration of dispatch.

¹⁰ The CAISO has not yet determined whether bidding activity rules are necessary for Participating Loads, which could place limits on changes to Bid prices for Load that has already been scheduled in the Day-Ahead Market.

¹¹ The Sub-LAPs that are used in the CRR allocation process are sub-areas of the Default LAPs, which have been based on the CAISO's previous analyses of congestion patterns. Defining the boundaries of Custom LAPs in this way is consistent with the CAISO's existing Participating Load Technical Standard, section 8.2, which states: "... The location of the Load must be included in the bids submitted to the CAISO. Loads posing potential Intra-Zonal Congestion problems will be identified and will not be allowed to participate. Preference will be given to Loads within areas where potential Congestion problems could be mitigated by Demand curtailment ... The ISO reserves the right to determine whether a group of Loads ... spans or interferes with an intra-zonal path." In Release 1A, the CAISO does not propose to exclude loads that have

California Independent System Operator

scheduling and dispatching Participating Load demand resources to appropriately manage congestion. Along with ensuring Real-Time reliability of the network, this can also help to ensure the feasibility of scheduling Load using the Default Load Aggregation Points (LAPs). If there are insufficient Bids available for Congestion Management of local network constraints, reductions of Load throughout a Default LAP may be necessary, and the result would be high LMPs in constrained locations since a large amount of Load must be rescheduled to relieve a constraint by a small amount. Having Energy Bids from Participating Load available to the CAISO at the local level reduces the risk of this outcome. The MRTU Release 1 tariff provides that a Participating Load resource is settled entirely at its location's LMP, including Minimum Load that is not included as a price-sensitive portion of the Energy Bid. Because consistent pricing is needed for scheduling and settlement, the Participating Load will continue to be settled at its location's LMP.

The example in Figure C illustrates how Participating Load would function with only an Energy Bid curve. In this example, the Participating Load has submitted an Energy Bid with four segments. Following the definition of Base Load in the MRTU Release 1 tariff ("the maximum consumption of a Participating Load as bid in the CAISO Markets by Scheduling Coordinators"), the highest MW level of the Energy Bid is labeled as the "Base Load". The lowest MW level of the Energy Bid is labeled as the "Minimum Load", and in this case (since there is only an Energy Bid, and no optional Bid components have been used), the Minimum Load is a Self-Schedule like a Price-Responsive Demand Bid could include. The Participating Load's Schedule would be determined economically within its Bid range, i.e., between its Minimum Load and Base Load. In this example, the fourth Bid segment's price is less than the market clearing price at its location, so its Schedule is at the break between its third and fourth Bid segment. This is shown as a reduction ("Load Curtailment") from its Base Load.¹²

different intra-zonal congestion impacts from participation, but instead has used congestion to define the boundaries of Sub-LAPs. The CAISO will review the Sub-LAP boundaries with the working group before Release 1A implementation.

¹² Optional Bid components are discussed in subsections below, but one merits discussion at this point. For a Participating Load that participates in Real-Time interval dispatch, a single bid segment could cover a larger MW range than the Participating Load is actually able to change within a 5-minute interval, and price changes between intervals could cause multiple Bid segments to be dispatched. The Participating Load can specify a Load Drop Rate and/or Load Pickup Rate that limits how fast the CAISO changes the Participating Load's dispatch.

The significance of the CAISO's "dispatch" of a Participating Load also needs to be understood. As noted previously, Loads and Curtailable Demand are not subject to the Uninstructed Deviation Penalty, if this provision of the CAISO Tariff is activated. The "Dispatch" simply informs the Participating Load of where its optimal operating point is, based on its submitted Bid.

California Independent System Operator

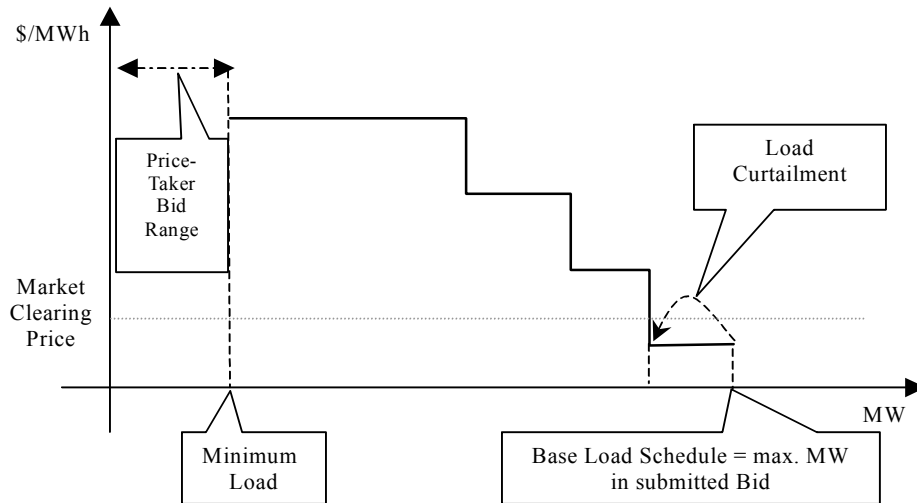

Figure C: Participating Load Energy Bid

The DAM uses hourly scheduling intervals for all loads, including Participating and non-Participating load. In the RTM, the dispatch interval for each Participating Load resource depends on the metering intervals that apply to the relevant end-use customers. Participating Load that is supported only by hourly metering can participate in RT dispatch using hourly intervals, which are provided in the Hour-Ahead Scheduling Process (HASP) but not in subsequent RT interval dispatch. For these Participating Loads, the process for submitting Settlement Quality Meter Data (SQMD) is the same as for non-Participating Load. For Participating Loads that participate in RT interval dispatch (which uses 5-minute dispatch intervals in MRTU), the SQMD needs to be submitted for 5-minute intervals, but the intervals within the meters may actually be 15-minute intervals. The CAISO allows the 15-minute underlying data to be reported by dividing it into the 5-minute reporting intervals required by SQMD. Except as needed to use 5-minute reporting intervals rather than 60-minute reporting intervals, the process for reporting these end-use customers' SQMD would also be the same as for non-Participating Loads.

Technical requirements for participation in Energy markets are limited to providing SQMD that meters Energy usage for the time intervals that match the market prices for the Participating Load's location, and establishment of Custom LAPs that identify the Participating Load's location. The additional metering requirements for Participating Loads, compared to non-Participating Loads, exist because settlement for hourly or sub-hourly prices requires accurate hourly or sub-hourly meter data (not data determined from load profiles). No telemetry is required for Participating Loads to participate in Energy markets (although the availability of telemetry will assist the CAISO in maintaining system reliability).

Participating Load: Optional Capacity Products

In addition to the basic functionality of participating in Energy markets, a Participating Load may optionally participate in the Residual Unit Commitment (RUC) process if it submits a RUC Availability Bid.¹³ The Participating Load model enables demand resources to offer all available

¹³ Participation in RUC may be required for Resource Adequacy (RA) Resources. A RUC Availability Bid of \$0/MWh is currently used for RA Resources that are required to bid into the CAISO Markets, and the CAISO expects this to continue in

California Independent System Operator

Ancillary Service products including Non-Spinning Reserve, Spinning Reserve, and Regulation.¹⁴ The eligible amount of AS capacity is the Load reduction that can be delivered within 10 minutes (which requires RT interval dispatch), and requires certification by the CAISO to ensure compliance with technical standards established by the Western Electricity Coordinating Council (WECC) and North American Electric Coordinating Council (NERC).¹⁵ Ancillary Services can be simultaneously self-provided for part of the resource's capacity, and bid for any remaining capacity using a single segment for the quantity and price of offered capacity. The RUC Availability Bid indicates the quantity and price of capacity that is offered to meet the CAISO's RUC Requirement. A RUC Award does not alter the Participating Load's DA Schedule, but obligates the bidder to offer the RUC capacity for Dispatch in RTM.

A summary of requirements for providing AS is as follows. Details of the technical specifications for Non-Spinning Reserve are documented in the CAISO's current Participating Load Technical Standard, which is available at <http://www.caiso.com/docs/2001/01/22/200101221153242073.pdf> and detailed technical specifications for provision of Spinning Reserve and Regulation will be developed through the working group process.

- **Non-Spinning Reserve:** In addition to the interval metering requirements for energy, Non-Spinning Reserve requires telemetry. Telemetry is required to abide by WECC and NERC standards. The WSCC Operating Reserve White Paper (<http://www.wecc.biz/documents/library/PWG/wsc6oprs.pdf>) states: "The WSCC [Minimum Operating Reliability Criteria] requires that system operators must know, at all times, the amount of Operating Reserve available which can be fully activated within the next 10-minutes. That means this information must be periodically calculated and displayed." CAISO Energy Management System (EMS) requires 4-second reporting intervals in a Scheduling Coordinator's Data Processing Gateway (DPG), but allows 1-minute updates from end-use meters to the Scheduling Coordinator's system. In other words, a DPG is not required at every load point, but a DPG must exist between the SC and the CAISO and be able to communicate with the CAISO on a 4-second basis. The limiting requirement is the one-minute updates that must occur between the SCs load points and the SCs DPG. Otherwise, except as necessary, metering and telemetry requirements for Participating Loads are the same as for non-Participating Loads.
- **Spinning Reserve:** In addition to the requirements for Non-Spinning Reserve, CAISO Tariff Appendix K (Ancillary Service Requirements Protocol) requirements for Spinning

Release 1A. However, bidding requirements for RA Resources are being developed through other regulatory and stakeholder processes, and are beyond the scope of this document. The CAISO intends to insert adjustments to the CAISO Forecast of CAISO Demand (CFCD) when Load Serving Entities (LSEs) inform the CAISO that they are implementing Day-Ahead demand response programs that are not bid into the CAISO Markets as Participating Load. The CFCD is the basis for the CAISO's capacity reservation in RUC. The CAISO anticipates that this will continue in Release 1A.

¹⁴ The CAISO will be updating its Participating Load Technical Standard as part of its implementation of Release 1A Participating Load functionality, to reflect the applicable requirements. As specific demand response resources demonstrate to the CAISO that they satisfy the performance requirements for Ancillary Service products, the CAISO will also ensure that WECC and NERC requirements are satisfied.

¹⁵ The CAISO's current Participating Load Technical Standard documents the requirements for providing Energy and Non-Spinning Reserve, and is available at <http://www.caiso.com/docs/2001/01/22/200101221153242073.pdf>. Telemetry for Non-Spinning Reserve is required by WECC and NERC standards, but Participating Loads do not need to provide Non-Spinning Reserve. The CAISO's Participating Load Technical Standard also limits the amount of Non-Spinning Reserve from loads that are reported through a single Data Processing Gateway to 400 MW, but this is not a limit on the total amount of Non-Spinning Reserve that can be provided by Participating Loads as a whole.

California Independent System Operator

Reserve include: (1) the resource must provide an automatic frequency response governor with minimum performance (5% droop,¹⁶ governor deadband must be ± 0.036 Hertz, and power output must change within one second for any frequency deviation outside the governor deadband), and (2) ability to “increase real power output” within one minute after instructions to dispatch Spinning Reserve.¹⁷ Qualification for Spinning Reserve will require certification by the CAISO and compliance with applicable technical standards.

- **Regulation:** The CAISO Tariff definition of Regulation is “The service ... capable of responding to the CAISO's direct digital control signals ... in an upward and downward direction to match, on a real-time basis, Demand and resources, consistent with established NERC and WECC operating criteria. ...”. In addition to the requirements for Spinning Reserve, WECC Minimum Operating Reliability Criteria (MORC) requirements for Regulating reserve include: “Sufficient spinning reserve, immediately responsive to automatic generation control (AGC) to provide sufficient regulating margin to allow the control area to meet NERC’s Control Performance Criteria.” Qualification for Regulation will require certification by the CAISO and compliance with applicable technical standards.

Participating Load: Other Optional Bid Components

In addition to the options stated above, the Participating Load model several optional Bid components that may be used by Participating Loads to guide how their capacity is dispatched in the CAISO Markets, but that are not required components. These are listed in the following table:

¹⁶ Droop measures the change in output as a percentage of capacity, in response to frequency deviations.

¹⁷ The requirements for frequency response may change when WECC adopts a separate Frequency Response Reserve.

California Independent System Operator

Comparison of Dispatchable Demand Resource Bid Components with Generation Resource		
Dispatchable Demand Resource		Generator Resource
Bid Component	Explanation	
Base Load Schedule	Expected Demand if not curtailed	Base Load
Minimum Load Reduction	Minimum amount of curtailment	Minimum generator output
Minimum Load	Minimum usage	Maximum generator output
Load Reduction Initiation Time	Time required to initiate load reduction	Start-up time
Minimum Load Reduction Time	Minimum time required to operate at reduced load after start of load reduction	Minimum up time
Maximum Load Reduction Time	Maximum time required to operate at reduced load after load reduction initiation	Maximum daily energy limit
Minimum Base Load Time	Minimum time after load restoration, before the next load reduction	Minimum down time
Maximum number of daily load curtailments	Maximum number of curtailments per day	Maximum number of daily starts
Minimum & Maximum Daily Energy Limit	Limits on daily energy from load reduction, if a Curtailable Demand Bid is dispatched	Maximum daily energy limit
Load Drop Rate	Ramp rate for load drop	Ramp up rate
Load Pickup Rate	Ramp rate for load pickup	Ramp down rate
Load Reduction Initiation Cost	Minimum curtailment cost, per curtailment	Start-up cost
Minimum Load Reduction Cost	Minimum curtailment cost, per hour	Minimum load cost

For end-use customers with hourly metering intervals, which would be eligible for dispatch in HASP, all optional Bid components apply in DAM, but the options in RTM are limited to:

- Base Load Schedule
- Minimum Load Reduction
- Minimum Load
- Maximum Load Reduction Time
- Minimum Base Load Time
- Maximum Number of Daily Load Curtailments,
- Maximum Daily Energy Limit
- Load Reduction Initiation Cost
- Minimum Load Reduction Cost

The availability of these Bid components provides Participating Loads with essentially the same flexibility that generators have in the CAISO Markets to ensure that the CAISO's Dispatch

California Independent System Operator

recognizes limitations in their availability.¹⁸ The Load Drop Rate and Load Pickup Rate Bid components, which indicate how fast the Participating Load can respond to the CAISO's Dispatch instructions, can be pertinent to all Participating Loads. In addition, the Minimum Load and Minimum Load Reduction can be relevant even if only the Energy Bid is submitted (without AS or RUC Bids). The remaining optional Bid components are meaningful if a Participating Load has a minimum amount of load, which is the "Minimum Load Reduction", that must be dispatched if any Load Curtailment is used; these are: Base Load Schedule, Minimum Load Reduction, Load Reduction Initiation Time, Minimum & Maximum Load Reduction Time, Minimum & Maximum Daily Energy Limit, Load Reduction Initiation Cost, and Minimum Load Reduction Cost.

The role of these optional Bid components can be seen by comparing Figure D, "Generator Bid", with Figure E, "Participating Load Bid with Minimum Load Reduction". The generator's output is variable within the range of its Energy Bid, but cannot operate below its "Gen Minimum Output". To reach its minimum output, the generator may incur start-up costs. To operate at its minimum output level, it may incur average costs that are higher than the incremental cost at points within its first Bid segment. The generator may have operating limits including how fast it can start, how long it must run once it starts, and how much Energy it can produce in a given day. The CAISO's market optimization software will take these costs and operating limits into account in determining the optimum Schedules for this and other supply resources. Similarly, the operation of the Participating Load shown in Figure E is variable within the range of its Energy Bid, but if it reduces its Demand below its Base Load, it must reduce by at least its Minimum Load Reduction. It may incur a minimum cost for starting each Load Curtailment, or an hourly cost for its minimum Load Curtailment that exceeds the price at which it can offer additional reductions in Demand. The Participating Load may have operating limits including how fast it can initiate its Load Curtailment, a minimum amount of time that it must remain off-line once it starts a Load Curtailment, a maximum duration of a Load Curtailment, or minimum or maximum amounts of Energy reduction during Load Curtailments. The attributes that the CAISO proposes to include as Bid components are listed in the table above, which the CAISO believes enables a very flexible array of options for tailoring and managing demand resources.

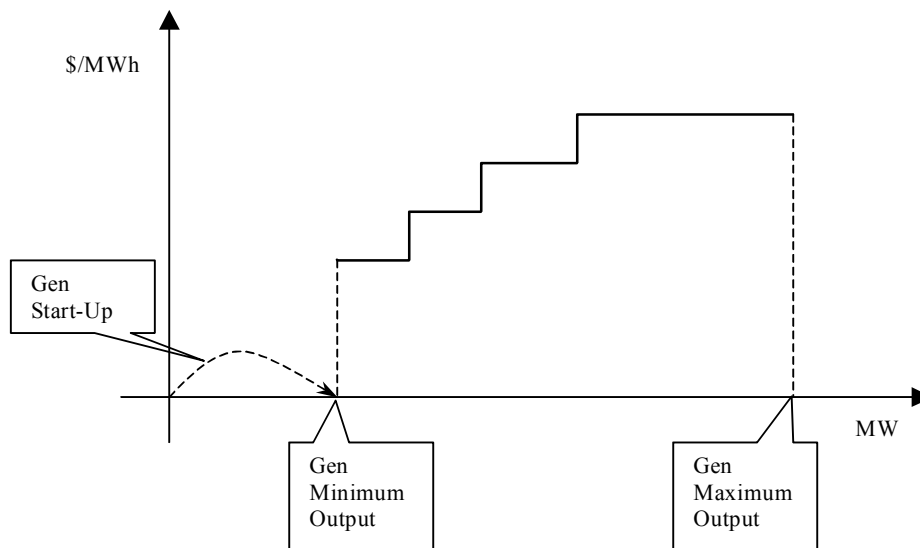

Figure D: Generator Bid

¹⁸ The CAISO compares the options available to Participating Loads and generators to demonstrate that its proposal provides comparable flexibility for scheduling in CAISO Markets, not to suggest that Participating Load is the same as generation.

California Independent System Operator

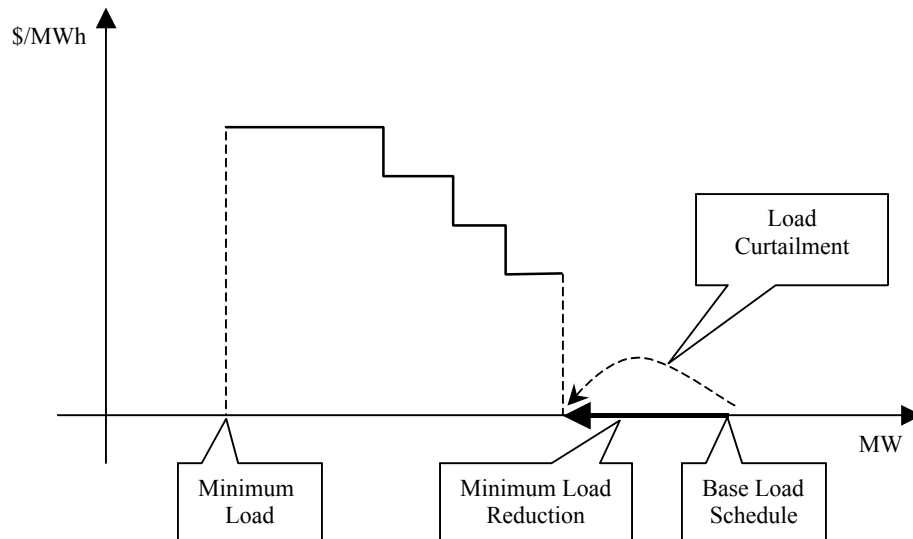

Figure E: Participating Load Bid with Minimum Load Reduction

Future Enhancement Possibilities

The CAISO also sees the development of this Straw Proposal as an opportunity to identify potential future enhancements to its Participating Load functionality. Examples of potential future enhancements include:

- It is possible that the RTM's clearing price may understate the value of ramping capacity, as short price spikes have occurred in the pre-MRTU market when economic resources cannot ramp quickly enough to meet changes in system Demand, or as sustained ramping periods have produced capacity shortages. Some demand resources can be among the sources of ramping capacity.
- Current Ancillary Service products (which provide 10-minute availability) may not be the best match for local supply scarcity (which requires availability in 20- to 30-minutes, or more). The creation of these reserve capacity products would be part of the CAISO's future evaluation of scarcity pricing, and is not currently planned for Release 1A.

The CAISO invites input, on an ongoing basis, as to whether these or other longer-term enhancements should become part of the Participating Load model. Because these topics would affect multiple types of resources, the CAISO would need to understand how any suggested enhancements would fit into its overall market development strategy, which is managed through a process known as the "Market Initiatives Roadmap". Once potential future enhancements are identified, they can be placed in the Roadmap process for prioritization among the CAISO's other initiatives.

Next Steps

The CAISO's publication of its June 26 Issue Paper, September 25 Draft Straw Proposal, October 25 Revised Draft Straw Proposal, and this Straw Proposal are the beginning of a process that will result in implementing improvements to the Participating Load functionality of MRTU Release 1. The CAISO's proposed schedule for moving toward implementation steps is as follows:

California Independent System Operator

- CAISO issues Straw Proposal to stakeholders: November 9, 2007
- Stakeholder comments requested on Straw Proposal for discussion at stakeholder meeting: November 26, 2007
- Stakeholder meeting: December 4, 2007
- Post-meeting stakeholder comments requested: December 11, 2007
- Working Group input on Business Practice Manual and User Guide begins: December 2007. Tasks include:
 - Identify data needs, data flow and associated timelines
 - Develop business rules and outline business process
 - Also develop necessary tariff modifications
- Complete BPM and User Guide: Summer 2008

The working group activity that begins in December will parallel internal CAISO work of software development, consisting of (1) CAISO software requirements going to the CAISO's vendor, and the vendor preparing its detailed design, in the first quarter of 2008, (2) vendor implementation, followed by several testing phases, and (3) CAISO integration testing after Summer 2008 and market simulation testing in the first quarter of 2009.

Through this process, both conceptual and implementation issues will be identified and explored. Among these is the need for bidding activity rules or other market power mitigation requirements, including but not limited to:

- Whether any controls must be established on the amount of Base Load that can be scheduled.
- Whether rules need to be established for Bid Cost Recovery to ensure that action by the Load was actually necessary to reduce its Demand. That is, there may be opportunities for Participating Loads to structure their Bids to be eligible for Bid Cost Recovery when their resulting Schedule is where they normally would be operating, with no actual demand response being necessary. It may be necessary to make Bid Cost Recovery subject to a validation of verifiable costs.¹⁹
- Whether telemetry (when available) or previous dispatch points should be used for the CAISO's dispatch for future intervals, and whether there are circumstances in which the CAISO should base its dispatch for future intervals on RT validation that a resource is complying with the CAISO's current dispatch.

¹⁹ In comments on the CAISO's Draft Straw Proposal, the California Department of Water Resources (CDWR) State Water Project suggested that the current design for verification of Bid Cost Recovery (BCR) is sufficient, and there should be no additional mechanism for verifying Participating Load's BCR. CDWR suggested that Base Load validation may occur through reference to a Participating Load's prior 10 days of operations or DAM schedules. Currently, the CAISO verifies the eligibility of BCR payment for a generator by checking whether the generator is self-committed or committed by the CAISO. CDWR suggests that the same mechanism can be applied to Participating Load, which should be treated the same as a generator. Regarding controls on the amount of Base Load, CDWR believes the Base Load (against which load drop is compared) can be best determined using that load's historical operation pattern when allowing Participating Load to submit load drop schedules in DAM. For instance, an average of the previous 10 days of metered demand could be used as the Base Load for validating Demand Response schedules in DAM. For RTM, the Base Load could be determined as that load's awarded schedule in DAM. Proposals such as CDWR's will be valuable input as the CAISO determines whether and how Base Load validation will need to occur. This will involve the design of compliance mechanisms, which can probably proceed on a different schedule than is necessary for developing the market software.

California Independent System Operator

- Whether there are circumstances that affect resources other than providers of AS in which the CAISO should receive “outage” notices that Participating Loads will be unable respond fully to the CAISO’s dispatch. (The CAISO will create a mechanism for providers of AS to notify the CAISO of conditions that restrict their availability for dispatch.)

Throughout the course of this project, the CAISO will coordinate its development of all Release 1A features, and identify both (a) any interactions between Convergence Bidding and Participating Load, and (b) the role of demand response in Scarcity Pricing.

Appendix

Development of Software Requirements for Participating Load (Post-Release 1)

1 Introduction

This document describes enhancements to functionality in Release 1 of the CAISO's Market Redesign and Technology Upgrade (MRTU) for Load resources that wish to actively participate in the CAISO Markets. These resources are known as "Participating Loads", and participate in the CAISO Markets through tariff provisions including the following definitions.²⁰

Participating Load: An entity, including an entity with Pumping Load, providing Curtailable Demand, which has undertaken in writing by execution of a Participating Load Agreement to comply with all applicable provisions of the CAISO Tariff, as they may be amended from time to time.

Curtailable Demand: Demand from a Participating Load or Aggregated Participating Load that can be curtailed at the direction of the CAISO in the Real-Time Dispatch of the CAISO Controlled Grid. Scheduling Coordinators with Curtailable Demand may offer it to the CAISO to meet Non-Spinning Reserve or Imbalance Energy.

Custom Load Aggregation Point (Custom LAP): An aggregation of Load PNodes created by the CAISO based on a set of custom LDFs submitted by a Scheduling Coordinator, at which such Scheduling Coordinator may submit a single Bid and settle Demand consistent with the CAISO Tariff rules, and for which the Scheduling Coordinator is required to submit to the CAISO Meter Data for the nodal Load represented in such aggregation.

MRTU Release 1 includes limited functionality for Participating Loads, and the CAISO intends to expand this functionality in Release 1A. In addition to participation in the Day-Ahead Market (DAM) providing opportunities for response by Participating Loads to the CAISO's needs for capacity that might not be available in the Real-Time Market (RTM) since the DAM allows end-use customers more time to plan their Energy consumption, and because the CAISO intends to procure 100% of its Ancillary Service (AS) capacity (e.g., Non-Spinning Reserve) in the DAM, the functionality described herein will be available in both the DAM and the RTM. For other types of resources, participation in the DAM and the RTM involve separate bidding and scheduling processes in most ways – differences involve aspects such as bidding activity rules, and scheduling priority in the RTM for schedules that have been established in the DAM. Similarly, the functionality described in this document is intended to apply to both the DAM and the RTM, as

²⁰ These provisions are from the CAISO Tariff for MRTU as of October 12, 2007.

California Independent System Operator

separate bidding and scheduling processes, except where specific differences are noted.

The scope of this document does not include the functionality for pumped storage hydro generation, for which MRTU Release 1 provides at least some functionality.

2 Load Aggregation

2.1 General Requirements

The MRTU market design aggregates Loads using Standard/Default Load Aggregation Points (Default LAPs) and Custom Load Aggregation Points (Custom LAPs). The CAISO will determine criteria for the designation of Custom LAPs. For scheduling and settlement, SCs may schedule Participating Load using a Custom LAP or at a nodal level if they are registered to schedule at the nodal level.²¹ The load that is scheduled at an aggregated level will be distributed to nodes according to relevant Load Distribution Factors (LDFs). The LDFs for the Custom LAPs for aggregated Participating Load are fixed (i.e., not variable) during the optimization. The Integrated Forward Market (IFM) / Residual Unit Commitment (RUC) application shall provide final DA and RT schedules at each bus and at the same aggregation level that SCs specified when they submitted their schedules.

For Custom LAPs, the minimum for the total size of an aggregation may be reduced to 0.1 MW, pending analysis of impacts on other CAISO systems.

2.2 LMPs for Aggregated Participating Load

A Participating Load aggregation is treated as an aggregate control in the optimization, with a fixed distribution to the underlying nodes using the relevant Custom LDFs. For Participating Load, the Locational Marginal Prices (LMPs) calculated at Aggregated Pricing Nodes (APNodes) are aggregated, weighted-averages of the LMPs at the Pricing Nodes (PNodes) that make up the APNodes, weighted by the same LDFs that are used to distribute the aggregated Participating Load Bid to nodes during the optimization.

Custom Load Aggregations that represent Participating Loads are excluded from the calculation of the aggregated LMPs for Default LAPs. While LDFs for Default LAPs' Load are determined based on historical State Estimator data, LDFs for Custom LAPs are established by the CAISO using data provided by the Scheduling Coordinator. A question to be resolved is whether Scheduling Coordinators should be able to update the LDFs for Custom LAPs through their Bid submissions, or remain as Master File data as in MRTU Release 1. Similarly, the frequency of updates of the static LDFs in the

²¹ Currently, a single SC submits Bids for both Energy and demand response. The CAISO is not changing this arrangement at this time. However, the underlying policy may change in the future, as a result of policies that may be established by the CPUC about the structure of retail markets. Among the many potential alternatives are:

- One SC could self-schedule Energy while a different SC submits a bid curve for demand response, or an Ancillary Service Bid, in the same market, or
- One SC could schedule a Participating Load in DAM while a different SC schedules the Participating Load in RTM.

Until the underlying policies about future retail market structure are determined, the CAISO cannot develop details of software requirements. However, the Release 1A software design should not assume that the same SC submits Bids for Energy and demand response.

California Independent System Operator

Master File based on nodal Meter Data, and requirements for hourly submission of nodal Meter Data for Settlement, need to be established.

3 Bids Usage and Treatment in IFM/RUC Application

3.1 Bids for Participating Loads

Bids for Participating Loads provide for participation in CAISO Markets beyond that of non-Participating Loads. Non-Participating Loads can submit a monotonically decreasing staircase curve having up to 10 segments defined by MW load levels and prices. This Bid curve applies to scheduling at a Default LAP. There are no inter-temporal constraints in the Bid for a non-Participating Load (i.e., it is not a three-part bid).

Participating Load shall be modeled at a specified node or Custom Load Aggregation. The Participating Load functionality supports a variety of Bid components in order to provide Scheduling Coordinators with flexible options for structuring Demand Response programs, including a three-part bid and certified operating limits, ramp up/down rates, and inter-temporal constraints, as detailed further below. A Participating Load may also provide AS²² with a capacity and energy bid up to a certified capacity, and may offer capacity for RUC.

Figure 1 shows an example of a Participating Load Energy Bid.

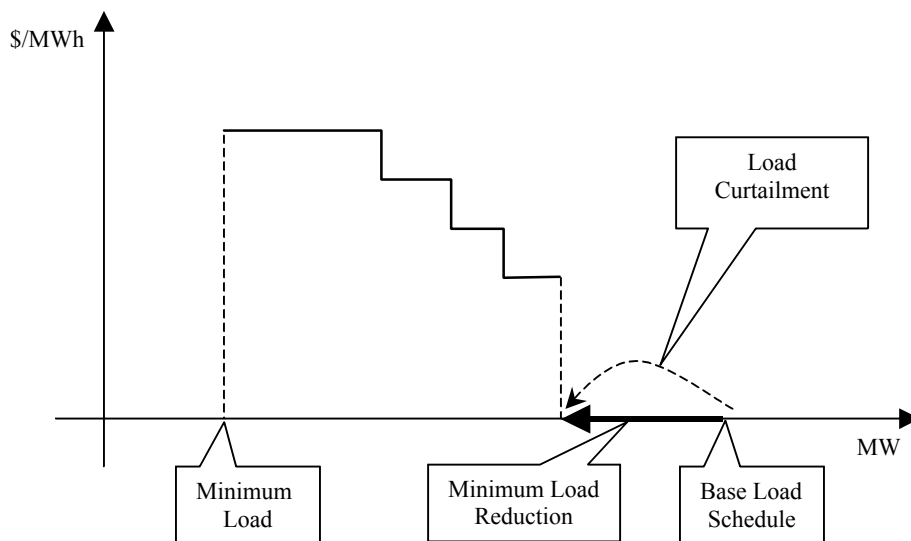

Figure 1. Participating Load Energy Bid

The Energy Bid Curve is required, but use of the other Bid components is optional. The three-part bid includes the following:

²² Ancillary Service bidding by Participating Loads will be provided in the market software systems for Non-Spinning Reserve, Spinning Reserve, Regulation Up, and Regulation Down.

California Independent System Operator

- Load Energy Bid curve (required, allows multiple segments)²³
- Load Reduction Initiation Cost (optional)²⁴
- Minimum Load Reduction Cost (optional)

A RUC Availability Bid is optional, but may be required if a Demand Resource is a Resource Adequacy Resource.²⁵

- RUC Availability Bid

The Participating Load model data provides the following additional Bid components,²⁶ which are included in submitted Bids only at the option of the Participating Load. Default values will be used if specific values are not submitted in the Bid for a Participating Load.²⁷

- Base Load Schedule (see discussion below)
- Load Reduction Initiation Time (the time required to initiate Load reduction – single segment)
- Minimum Load Reduction Time (the minimum time required to operate at reduced load after load reduction initiation)
- Maximum Load Reduction Time (the maximum time required to operate at reduced load after load reduction initiation)

²³ The energy bid that is submitted by the Scheduling Coordinator has up to ten segments. But the Scheduling Infrastructure and Business Rules (SIBR) system may add up to ten additional segments from the proxy bid curve. Therefore the energy bid that is passed to the IFM from SIBR may have up to 20 segments. In addition, the IFM application may add additional segments to represent various self-scheduling priorities.

Any Demand that is scheduled using Transmission Ownership Right (TOR) or Existing Transmission Contract (ETC) capacity must be scheduled as a price taker at a MW level no higher than the Minimum Load. This applies to Participating Load as well as to Non-Participating Load.

²⁴ The use of the Load Reduction Initiation Cost and Minimum Load Reduction Cost require that a Bid may also include a Minimum Load Reduction.

²⁵ The CAISO's development of Participating Load functionality in its market systems does not determine either the requirements for Resource Adequacy Resources to bid into CAISO markets or the eligibility of Load to qualify as a Resource Adequacy Resource.

²⁶ This list of Bid components is based on the CAISO's previous Software Requirements Specification Addendum for the Real Time Market, version 1.2, from which the CAISO's vendor prepared a detailed design. Bid components that are now being added to this list, because of requests by CAISO Market Participants, are separately stated.

²⁷ The default values are:

- Base Load Schedule: maximum MW in Energy Bid
- Load Reduction Initiation Time: zero
- Minimum Load Reduction Time: zero
- Maximum Load Reduction Time: unlimited (i.e., a large number)
- Load Drop Rate: unlimited (i.e., a large number)
- Load Pickup Rate: unlimited (i.e., a large number)
- Minimum and Maximum Daily Energy Limits: minimum = zero, maximum = unlimited (i.e., a large number)
- Minimum Base Load Time: zero
- Maximum Number of Daily Curtailments: unlimited (i.e., a large number)
- Maximum Non-Spinning Reserve Capacity: zero
- Maximum Spinning Reserve Capacity: zero
- Maximum Regulation-Up Capacity: zero
- Maximum Regulation-Down Capacity: zero

California Independent System Operator

- Load Drop Rate (the ramp rate for load drop)
- Load Pickup Rate (the ramp rate for load pickup)
- Minimum and Maximum Daily Energy Limits (limits on daily energy from load reduction, if a Curtailable Demand Bid is dispatched)
- Maximum Non-Spinning Reserve Capacity (MW and price for load reduction within 10 minutes, for qualified resources)²⁸

Additional Bid components have been requested by the CAISO's Market Participants as being necessary for specific business requirements:

- Minimum Base Load Time (minimum time after load restoration, before another Load reduction is dispatched),
- Maximum Number of Daily Load Curtailments,
- Maximum Spinning Reserve Capacity (MW and price for load reduction within 10 minutes, for qualified resources)
- Maximum Regulation-Up Capacity (MW and price for load reduction within 10 minutes, for qualified resources)
- Maximum Regulation-Down Capacity (MW and price for load increase within 10 minutes, for qualified resources)²⁹

The three-part Energy Bid Curve in RTM may be submitted for either the Hour-Ahead Scheduling Process (HASP) or Real-Time interval dispatch process (RTID), depending on the type of meter installed for the end-use customers, and the available Bid components between these options. The Real-Time (RT) dispatch for end-use customers with metering intervals of less than one hour (e.g., 15-minute intervals) will occur in RTID, and all of the optional Bid components listed above are applicable for Bids in RTM. The RT dispatch for end-use customers with hourly metering intervals will occur in HASP and settled at HASP prices, and while all optional Bid components (except AS eligibility) are applicable to these end-use customers in DAM, the optional Bid components in HASP (in addition to a multi-segment Energy Bid that can include a Minimum Load greater than zero) are limited to:

- Base Load Schedule
- Minimum Load Reduction
- Load Reduction Initiation Cost
- Minimum Load Reduction Cost
- Maximum Load Reduction Time
- Maximum Daily Energy Limit
- Minimum Base Load Time

²⁸ All Ancillary Services provided by Participating Loads may be simultaneously self-provided for part of the resource's capacity, and bid for remaining capacity. If a Participating Load's Ancillary Service capacity Bid is accepted in DAM, then its Energy Bid range in RTM must be at least as much as the awarded Ancillary Service capacity.

²⁹ An end-use customer may provide Regulation-Down by using an energy storage system to manage its regular load. As a result, it may have a negative load (net positive injection) from time to time. The market software must accommodate variable, negative loads.

California Independent System Operator

- Maximum Number of Daily Load Curtailments,

A Participating Load may specify a “Base Load” as part of its Bid.³⁰ The specification of a Base Load causes the Bid to be treated differently in the optimization if the Base Load exceeds the maximum MW of Load that is stated in its Energy Bid. The two options are:

1. If the Participating Load designates a Base Load that is higher than the maximum MW of Load that is stated in its Energy Bid, then the difference between (a) its designated Base Load, and (b) the maximum MW of Load that is stated in its Energy Bid, defines the “Minimum Load Reduction”. That is, the CAISO’s optimization may set the Schedule for the Participating Load either (a) at the designated Base Load or (b) within the range of the Energy Bid, but the CAISO’s optimization shall not schedule the Participating Load within the range defined as the Minimum Load Reduction. So that the CAISO’s optimization considers a meaningful decision between these two points, the Base Load is considered to be a Self-Schedule by the Participating Load if the Minimum Load Reduction is greater than zero (i.e., if the Base Load is higher than the maximum MW of Load that is stated in its Energy Bid). The CAISO’s optimization then determines whether to accept the Participating Load’s Bid to reduce its Demand below its Base Load.

If a Participating Load’s Bid includes a Minimum Load Reduction, then its Bid may also include (a) a Load Reduction Initiation Cost (which is a fixed cost for reducing Load below the Base Load, regardless of the duration of reduction below the Base Load), and/or (b) a Minimum Load Reduction Cost (which is an hourly cost of reducing Load below the Base Load). The Load Reduction Initiation Cost and Minimum Load Reduction Cost will affect the CAISO optimization’s determination of whether (a) the Participating Load’s optimal schedule remains at its Base Load (i.e., the combination of Energy Bid, Load Reduction Initiation Cost, and Minimum Load Reduction Cost does not make it economic to reduce the Participating Load’s Schedule below the Base Load, which is its Self-Schedule if its Curtailable Demand Bid is not accepted), or (b) its Curtailable Demand Bid is accepted and it is scheduled at a lower MW level within the range of the Energy Bid.

2. If the Participating Load’s Bid does not designate a Base Load, or the designated Base Load does not exceed the maximum MW of Load that is stated in its Energy Bid, it is considered to be able to provide Demand Response over the entire range of its Energy Bid, and its Base Load is treated as the maximum MW of Load that is stated in its Energy Bid.³¹ In this case, the minimum MW of Load in its Energy Bid (i.e., the start of its first submitted Bid segment) constitutes the Participating Load’s Self-Schedule. This Self-Schedule up to the start of the first energy bid point is a “price taker”, i.e., it is charged the relevant aggregate LMP regardless of its dispatched level up to the self-scheduled MW, as is any non-Participating Load. In the CAISO’s optimization, scheduling of the self-scheduled MW is implemented for Congestion Management by inserting “uneconomic” Bid

³⁰ The MRTU Release 1 tariff defines “Base Load” as “the maximum consumption of a Participating Load as bid in the CAISO Markets by Scheduling Coordinators.”

³¹ If the Base Load does not exceed the maximum MW of Load that is stated in its Energy Bid, its Minimum Load Reduction equals zero. If a Participating Load’s Bid states a Load Reduction Initiation Cost and/or Minimum Load Reduction Cost but does not have a Minimum Load Reduction greater than zero, then the Load Reduction Initiation Cost and/or Minimum Load Reduction Cost will be ignored.

California Independent System Operator

segments between zero MW and the self-scheduled MW, based on artificial prices (“penalty prices”, in optimization terms) that reflect various scheduling priorities, such as TOR and ETC schedules, etc. – the same as is the case for non-Participating Load.³²

For Generating Units, a resource’s minimum load (“Pmin”) is registered in the CAISO’s Master File, and changes to the resource’s minimum load due to derates are reported in SLIC or the Siemens Outage Scheduler. For a Participating Load, the Minimum Load Reduction is submitted implicitly with the energy bid, as the difference between Base Load and the last (highest) MW Energy Bid quantity. Thus, there is no need for updates to be received from SLIC or the Siemens Outage Scheduler for Participating Loads that provide only Energy. For Participating Loads that provide AS, the CAISO will define a mechanism (e.g., SLIC) for reporting that the awarded AS is unavailable.

3.2 RUC Participation

By submitting a RUC Availability Bid, a Participating Load indicates the quantity (MW) and price (\$/MWh) at which it offers to sell capacity for the specified interval of time to meet the CAISO’s Residual Unit Commitment requirement. The CAISO’s acceptance of a RUC Availability Bid does not alter the Participating Load’s DA Schedule, but obligates the bidder to offer the RUC capacity for dispatch in RTM. A RUC participation flag that is contained in its Bid submitted to the IFM controls participation of each Participating Load in RUC. For Load resources, only Participating Loads can participate in RUC.³³ The RUC participation flag has the same values that are defined for generators.

Participating Loads may be required to submit RUC Availability Bids of \$0/MWh for their RUC capacity, and to be excluded from receiving RUC payments. The CAISO will determine the requirements for validating and/or adjusting RUC Availability Bids and for RUC settlements in a future version. However, bidding requirements for RA Resources are being developed through other regulatory and stakeholder processes, and are beyond the scope of this document.

3.3 Market Power Mitigation

The CAISO will determine Market Power Mitigation requirements once the general design of the Participating Load functionality is established, through consultation with its Department of Market Monitoring. This may include bidding activity rules or other requirements.

³² If the Base Load exceeds the maximum MW of Load that is stated in its Energy Bid, and therefore its Base Load is its Self-Schedule, the CAISO’s optimization shall also insert “uneconomic” Bid segments for Congestion Management between zero MW and the lowest MW level in the Energy Bid curve. However, the Base Load constitutes the “price taker” Self-Schedule if the optimization does not accept the Curtailable Demand Bid.

³³ In cases where Load-Serving Entities have Demand Response programs that utilize the CAISO’s Non-Participating Load functionality, the CAISO may adjust the RUC procurement target using the same mechanisms that are being defined and used prior to implementation of the expanded functionality described herein.

California Independent System Operator

4 Modeling of Participating Load Resources in Optimization

This section builds on the previous sections by describing the Participating Load model's formulation in optimization terms, as part of implementing the business requirements stated above.³⁴ The functionality described herein anticipates the use of an explicit Participating Load Resource model with an example of a three-part bid as follows:

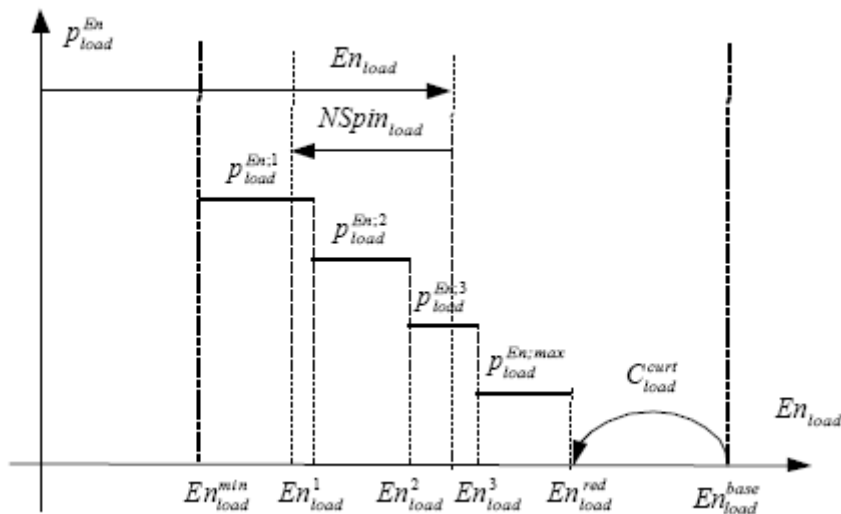

Figure 2. Participating Load Resource model

The contribution of a dispatched Participating Load Resource at time period t in the objective function of the DAM and RTM is as follows:³⁵

$$C_{load}^{curr} + C_{load}^{min} - C_{load}^{En}(En_{load}^t) + C_{load}^{NSpin}(NSpin_{load}^t) \quad (1)$$

Where:

- En_{load} is the dispatch (DOT);
- En_{load}^{base} is the Base Load;
- En_{load}^{red} is the dispatch at Minimum Load Reduction;
- En_{load}^{min} is the minimum dispatch;
- En_{load}^i for $i=1,2,\dots,n$; define the segments of the energy bid;
- $P_{load}^{En:i}$ for $i=1,2,\dots,n$; are the prices of the energy bid segments;
- $C_{load}^{En}(En_{load})$ is the energy bid (the incremental cost as a function of dispatch);

³⁴ The latest description of the Participating Load functionality for MRTU Release 1 was stated in the CAISO's Software Requirements Specification Addendum for the Real Time Market, version 1.2, and has been adapted for the current document.

³⁵ At present, this equation only includes Non-Spinning Reserve as an Ancillary Service. It will be expanded to include all applicable Ancillary Services.

California Independent System Operator

C_{load}^{curt}	is the Load Reduction Initiation Cost (the cost to initiate load reduction);
C_{load}^{min}	is the Minimum Load Reduction Cost (the cost/hr to operate at reduced load); and
$NSpin_{load}$	is the Non-Spinning Reserve Award;
C_{load}^{NSpin}	is the Non-Spinning Reserve Bid Price.
$Spin_{load}$	is the Spinning Reserve Award;
C_{load}^{Spin}	is the Spinning Reserve Bid Price.
$RegUp_{load}$	is the Regulation-Up Award;
C_{load}^{RegUp}	is the Regulation-Up Bid Price.
$RegDown_{load}$	is the Regulation-Down Award;
$C_{load}^{RegDown}$	is the Regulation-Down Bid Price.

The following inter-temporal constraints apply to Participating Load Resources:

- Load Reduction Initiation Time (the time required to initiate load reduction);
- Minimum Load Reduction Time (the minimum time required to operate at reduced load after load reduction initiation);
- Maximum Load Reduction Time (the maximum time required to operate at reduced load after load reduction initiation);
- Load Drop Rate (the ramp rate for load drop);
- Load Pickup Rate (the ramp rate for load pickup);
- Minimum and Maximum Daily Energy Limits (limits on daily energy from load reduction);
- Minimum Base Load Time (minimum time after load restoration, before another Load reduction is dispatched);
- Maximum Number of Daily Load Curtailments.

Participating Loads will not contribute reactive power capacity for voltage regulation.

5 Settlement Principles

The basic principle for financial Settlements for this Participating Load model is that DAM and RTM establish scheduled levels of operation, which creates a financially binding DA Schedule for purchases at the CAISO's DA LMPs, and that the final Settlement in RTM will be based on the difference between Settlement Quality Meter Data and the DA Schedule, priced at RT LMPs. The benefit of being a Participating Load rather than a non-Participating Load is the ability to offer Bids in RTM that will receive Dispatches from the CAISO that indicate opportunities to be paid at least the Bid

California Independent System Operator

price for Load reductions as well as to buy additional Energy at no more than the Bid price, to respond to locational prices for Energy purchases in DAM as well as RTM, and (if qualified) to earn capacity payments for RUC and Ancillary Services.

In addition, to the extent that a Participating Load includes a Load Reduction Initiation Cost and/or hourly Minimum Load Reduction Cost in its Bid, it will be assured that its market revenues for Load reductions in DAM or RTM will be at least as much as these Bid components. The principles for Bid cost recovery will be the same as for other resources, as described in the CAISO Tariff.

6 Changes from Software Requirements Specification for MRTU Release 1

An implementation of the Participating Load model was included in MRTU Release 1 and was partially implemented, but as other aspects of the MRTU Release 1 design evolved, not all market design features of the Participating Load model could be conformed to the overall design within the required timeframe. The latest description of the Participating Load functionality for MRTU Release 1 was stated in the Software Requirements Specification Addendum for the Real Time Market, version 1.2, and has been adapted for the current document.

In the original design, a Participating Load was required to self-schedule a “Base Load” in the IFM in order to provide Demand Response and/or Non-Spinning Reserve. The “Base Load” Self Schedule would be a price taker, i.e., it would be charged the relevant aggregate LMP, like any non-Participating Load. Using the “Base Load” as its initial schedule, Demand Response would be provided using a three-part Bid and certified operating limits, ramp up/down rates, and inter-temporal constraints. When the Participating Load would be dispatched (curtailed) from its Base Load, it would be paid the LMP for the Load reduction at its specific location, in addition to being charged for its Base Load at the Default LAP price. The Participating Load would be eligible for recovering its Load Reduction Initiation Cost and its hourly Minimum Load Reduction Cost through Bid cost recovery. The original design’s difference in Settlement between the Base Load and reductions from the Base Load led to requirements (1) for the Participating Load to qualify for locational pricing of its demand response by registering a minimum value for its Minimum Load Reduction in the CAISO’s Master File, (2) for the Scheduling Infrastructure and Business Rules (SIBR) system to validate that the Participating Load’s Base Load exceeds the highest Energy Bid quantity by no less than the registered Minimum Load Reduction, and (3) for the optimization process to check whether a derate had increased the Minimum Load Reduction below the last energy bid quantity, and potentially delete the overlapping portion of the energy bid for the duration of the derate. Non-Spinning Reserve would optionally be provided with a capacity and Energy Bid up to a certified capacity, subject to Demand Response plus Non-Spinning Reserve not exceeding the Base Load schedule.

The revised design requirements described in this document are very similar to the original design requirements. One difference is that the Base Load will now be settled at the same locational price as reductions from the Base Load. As a result, there is no need to limit to a Master File value, or validate the Minimum Load Reduction against a Master File value, and the implementation is simplified. This also results in a more flexible design from the perspective of the Participating Load, which can determine whether its own business needs justify defining a Minimum Load Reduction.

California Independent System Operator

The original design would have also required validation that the Base Load could be scheduled as a Self-Schedule as part of the Default LAP, separately from the determination of whether Load reductions should be dispatched at the locational price, whereas the current design allows the use of a single Energy Bid. The current design sets the “self-scheduled” quantity differently depending on whether the Participating Load’s Bid includes a Minimum Load Reduction, but this is more a matter of semantics than of constructing the bid curve in the optimization process. By avoiding the requirement for each Participating Load to have a Minimum Load Reduction greater than zero, the current design may improve the performance of the optimization process.

The original design also contains references to (a) a separate hour-ahead market and (b) binding scheduling and dispatch in the Hour-Ahead Scheduling Process for resources that also participate in RTID, which are no longer part of the MRTU design. This updated statement of software requirements provides an option for some Participating Loads to be dispatched in HASP instead of RTID, which is similar to HASP’s operation for inertie resources. For Participating Loads, this updated document allows optional Bid components in HASP that are not available to inertie resources in HASP, but these are a subset of the options that are available to generators in RTID. This document adds Bid components that were not available to Participating Loads in the previous Software Requirements Specification, although these are among the Bid components available to generators.

Although it appears that the current design simplifies the implementation, whether these changes do facilitate the implementation of the Participating Load model will need to be determined through consultation with the vendor while the design is being completed.