

APPENDIX G: 2028 LOCAL CAPACITY TECHNICAL STUDY

Intentionally left blank

Executive Summary

This report documents the results of the 2028 Long-Term Local Capacity Technical (LCT) Study. The LCT Study objectives, inputs, methodologies and assumptions are the same as those discussed in the 2019 LCT Study to be adopted by the CAISO and submitted to the CPUC for adoption in its 2019 Local Resource Adequacy process.

Overall, the Local Capacity area resource Requirements (LCR) trend compared with 2023, is down by about 113 MW or about 0.5%. It is worth mentioning the following areas: (1) LA Basin and Big Creek/Ventura where LCR has decreased mostly due to load forecast; (2) San Diego/Imperial Valley where LCR has decreased mostly due to new effective resources (during NQC dispatch); (3) Sierra, Fresno and Kern where LCR has decreased mostly due to new transmission projects; (4) North Coast/North Bay, Stockton and Bay Area where LCR has increased mainly due to load forecast increase; (5) Humboldt, where LCR needs are steady.

The load forecast used in this study is based on the final adopted California Energy Demand Updated Forecast, 2018-2030 developed by the CEC; namely the load serving entity (LSE and balancing authority (BA) mid baseline demand with low additional achievable energy efficiency and photo voltaic (AAEE-AAPV), re-posted on 2/21/2018: http://www.energy.ca.gov/2017_energypolicy/documents/index.html#02212018.

The 2028 and 2023 total LCR needs are provided below for comparison:

2028 Local Capacity Needs

Local Area Name	Qualifying Capacity			2028 LCR Need Based on Category B			2028 LCR Need Based on Category C with operating procedure		
	QF/ Muni (MW)	Market (MW)	Total (MW)	Existing Capacity Needed	Deficiency	Total (MW)	Existing Capacity Needed**	Deficiency	Total (MW)
Humboldt	0	202	202	117	0	117	170	0	170
North Coast/ North Bay	119	736	855	855	26*	881	855	28*	883
Sierra	1146	1004	2150	1053	0	1053	1510	0	1510
Stockton	144	540	684	303	0	303	324	213*	537
Greater Bay	627	6984	7611	4795	0	4795	5396	204*	5600
Greater Fresno	334	3174	3508	1628	0	1628	1728	0	1728
Kern	13	462	475	0	0	0	137	3*	140
LA Basin	1443	6841	8284	5526	0	5526	6590	0	6590
Big Creek/ Ventura	424	3087	3511	2095	0	2095	2131	114*	2245
San Diego/ Imperial Valley	106	4402	4508	3908	0	3908	3908	0	3908
Total	4356	27432	31788	20280	26	20306	22749	562	23311

2023 Local Capacity Needs

Local Area Name	Qualifying Capacity			2023 LCR Need Based on Category B			2023 LCR Need Based on Category C with operating procedure		
	QF/ Muni (MW)	Market (MW)	Total (MW)	Existing Capacity Needed	Deficiency	Total (MW)	Existing Capacity Needed**	Deficiency	Total (MW)
Humboldt	0	202	202	111	0	111	169	0	169
North Coast/ North Bay	119	771	890	553	0	553	553	0	553
Sierra	1146	1004	2150	1268	0	1268	1924	0	1924
Stockton	144	540	684	225	20*	245	333	106*	439
Greater Bay	627	6427	7054	3676	0	3676	4752	0	4752
Greater Fresno	340	3169	3509	1688	0	1688	1688	0	1688
Kern	13	462	475	152	6*	158	174	8*	182
LA Basin	1443	6868	8311	6793	0	6793	6793	0	6793
Big Creek/Ventura	424	3083	3507	2212	0	2212	2690	102*	2792
San Diego/ Imperial Valley	106	4381	4487	4132	0	4132	4132	0	4132
Total	4362	26907	31269	20810	26	20836	23208	216	23424

* No local area is “overall deficient”. Resource deficiency values result from a few deficient sub-areas; and since there are no resources that can mitigate this deficiency the numbers are carried forward into the total area needs. Resource deficient sub-area implies that in order to comply with the criteria, at summer peak, load may be shed immediately after the first contingency.

** Since “deficiency” cannot be mitigated by any available resource, the “Existing Capacity Needed” will be split among LSEs on a load share ratio during the assignment of local area resource responsibility.

The narrative for each Local Capacity Area lists important new projects included in the base cases as well as a description of reason for changes between the 2023 Long-Term LCT study and this 2028 Long-Term LCT study.

This 2028 Long-Term Local Capacity Technical (LCT) Study was prepared in keeping with the ISO’s current commitment to prepare biennial 10-year local capacity technical studies on an informational basis, to assist with the CPUC’s Integrated Resource Planning processes.

This 10-year study is the first prepared by the ISO that provides stakeholders with comprehensive load profile and transmission capacity profile information to provide additional insight into the nature of the local capacity needs additional information to understand the nature. As well, in keeping with the stated intent in the 2018-2019 transmission planning process, the ISO has explored and identified alternatives for reducing reliance on local gas-fired generation capacity in at least half of the areas and sub-areas. Several of these alternatives were transitioned to the ISO’s economic study phase in this transmission planning cycle for further consideration as potential economic-driven transmission solutions.

Further, the ISO has provided a general assessment of the volume of gas-fired generation in each local capacity area based on general flexibility attributes that could make the generation more or less useful as system resources, as well as delineating the volume that is in or out of

disadvantaged communities. The categorization as more or less useful for system and flexibility needs is confidential, as it was based on confidential market information. Also, the data is only provided at an area or large sub-area basis to maintain confidentiality of the ranking of specific generators. The ISO considers that this information, coupled with the broader data regarding needs and the type and cost of potential mitigations, will be helpful in future resource planning discussions.

Intentionally left blank

Table of Contents

Executive Summary	1
1 Overview of the Study: Inputs, Outputs and Options.....	6
1.1 Objectives	7
1.2 Key Study Assumptions	7
1.2.1 Inputs and Methodology	7
1.3 Grid Reliability	9
1.4 Application of N-1, N-1-1, and N-2 Criteria	10
1.5 Performance Criteria	10
1.5.1 Performance Criteria- Category B.....	10
1.5.2 Performance Criteria- Category C	11
1.5.3 CAISO Statutory Obligation Regarding Safe Operation	12
1.6 The Two Options Presented In This LCT Study Report.....	15
1.6.1 Option 1 - Meet Performance Criteria Category B	15
1.6.2 Option 2 - Meet Performance Criteria Category C and Incorporate Suitable Operational Solutions	16
2 Assumption Details: How the Study was Conducted.....	17
2.1 System Planning Criteria.....	17
2.1.1 Power Flow Assessment:	18
2.1.2 Post Transient Load Flow Assessment:.....	19
2.1.3 Stability Assessment:	19
2.2 Load Forecast	19
2.2.1 System Forecast	19
2.2.2 Base Case Load Development Method	20
2.3 Power Flow Program Used in the LCR analysis	21
3 Locational Capacity Requirement Study Results	22
3.4 Summary of Study Results.....	22
3.5 Summary of Results by Local Area	25
3.5.1 Humboldt Area	25
3.5.2 North Coast / North Bay Area	29
3.5.3 Sierra Area	37
3.5.4 Stockton Area.....	53
3.5.5 Greater Bay Area	66
3.5.6 Greater Fresno Area	97
3.5.7 Kern Area.....	123
3.5.8 Big Creek/Ventura Area.....	138
3.5.9 LA Basin Area	148
3.5.10 San Diego-Imperial Valley Area.....	160
3.5.11 Valley Electric Area	183
Attachment A – List of physical resources by PTO, local area and market ID	184
Attachment B – Effectiveness factors for procurement guidance.....	234
Attachment C – Gas-fired generation based on general flexibility attributes	253

Intentionally left blank

1 Overview of the Study: Inputs, Outputs and Options

1.1 Objectives

The intent of the 2028 Long-Term LCT Study is to identify specific areas within the CAISO Balancing Authority Area that have limited import capability and determine the minimum generation capacity (MW) necessary to mitigate the local reliability problems in those areas, as was the objective of all previous Local Capacity Technical Studies.

This 2028 Long-Term Local Capacity Technical (LCT) Study was prepared in keeping with the ISO's current commitment to prepare biennial 10-year local capacity technical studies on an informational basis, to assist with the CPUC's Integrated Resource Planning processes.

This 10-year study goes beyond the scope of previous 10-year local capacity technical studies and is the first prepared by the ISO that provides stakeholders with comprehensive load profile and transmission capacity profile information to provide additional insight into the nature of the local capacity needs additional information to understand the nature. As well, in keeping with the stated intent in the 2018-2019 transmission planning process, the ISO has explored and identified alternatives for reducing reliance on local gas-fired generation capacity in at least half of the areas and sub-areas. Several of these alternatives were transitioned to the ISO's economic study phase in this transmission planning cycle for further consideration as potential economic-driven transmission solutions.

Further, the ISO has provided a general assessment of the volume of gas-fired generation in each local capacity area based on general flexibility attributes that could make the generation more or less useful as system resources, as well as delineating the volume that is in or out of disadvantaged communities. This is provided in Attachment C attached to this report. The categorization of generators as more or less useful for system and flexibility needs is confidential, as it was based on confidential market information. Also, the data is only provided at an area or large sub-area basis to maintain confidentiality of the ranking of specific generators. The ISO considers that this information, coupled with the broader data regarding needs and the type and cost of potential mitigations, will be helpful in future resource planning discussions.

1.2 Key Study Assumptions

1.2.1 Inputs and Methodology

The CAISO used the same Inputs and Methodology as agreed upon by interested parties and previously incorporated into the 2019 LCT Study. The following table sets forth a summary of the approved inputs and methodology that have been used in the 2019 LCT Study as well as this 2028 LCT Study:

Table 1.2-1 Summary Table of Inputs and Methodology Used in this LCT Study:

Issue	How Incorporated into THIS LCT Study:
Input Assumptions:	
Transmission System Configuration	The existing transmission system has been modeled, including all projects operational on or before June 1, of the study year and all other feasible operational solutions brought forth by the PTOs and as agreed to by the CAISO.
Generation Modeled	The existing generation resources has been modeled and also includes all projects that will be on-line and commercial on or before June 1, of the study year
Load Forecast	Uses a 1-in-10 year summer peak load forecast
Methodology:	
Maximize Import Capability	Import capability into the load pocket has been maximized, thus minimizing the generation required in the load pocket to meet applicable reliability requirements.
QF/Nuclear/State/Federal Units	Regulatory Must-take and similarly situated units like QF/Nuclear/State/Federal resources have been modeled on-line at qualifying capacity output values for purposes of this LCT Study.
Maintaining Path Flows	Path flows have been maintained below all established path ratings into the load pockets, including the 500 kV. For clarification, given the existing transmission system configuration, the only 500 kV path that flows directly into a load pocket and will, therefore, be considered in this LCT Study is the South of Lugo transfer path flowing into the LA Basin.

Performance Criteria:	
Performance Level B & C, including incorporation of PTO operational solutions	This LCT Study is being published based on Performance Level B and Performance Level C criterion, yielding the low and high range LCR scenarios. In addition, the CAISO will incorporate all new projects and other feasible and CAISO-approved operational solutions brought forth by the PTOs that can be operational on or before June 1, of the study year. Any such solutions that can reduce the need for procurement to meet the Performance Level C criteria will be incorporated into the LCT Study.
Load Pocket:	
Fixed Boundary, including limited reference to published effectiveness factors	This LCT Study has been produced based on load pockets defined by a fixed boundary. The CAISO only publishes effectiveness factors where they are useful in facilitating procurement where excess capacity exists within a load pocket.

Further details regarding the 2019 as well as 2028 LCT Study methodology and assumptions are provided in Section III, below.

1.3 Grid Reliability

Service reliability builds from grid reliability because grid reliability is reflected in the Reliability Standards of the North American Electric Reliability Council (NERC) and the Western Electricity Coordinating Council (“WECC”) Regional Criteria (collectively “Reliability Standards”). The Reliability Standards apply to the interconnected electric system in the United States and are intended to address the reality that within an integrated network, whatever one Balancing Authority Area does can affect the reliability of other Balancing Authority Areas. Consistent with the mandatory nature of the Reliability Standards, the CAISO is under a statutory obligation to ensure efficient use and reliable operation of the transmission grid consistent with achievement of the Reliability Standards.¹ The CAISO is further under an obligation, pursuant to its FERC-approved Transmission Control Agreement, to secure compliance with all “Applicable Reliability Criteria.” Applicable Reliability Criteria consists of the Reliability Standards as well as reliability criteria adopted by the CAISO (Grid Planning Standards).

¹ Pub. Utilities Code § 345

The Reliability Standards define reliability on interconnected electric systems using the terms “adequacy” and “security.” “Adequacy” is the ability of the electric systems to supply the aggregate electrical demand and energy requirements of their customers at all times, taking into account physical characteristics of the transmission system such as transmission ratings and scheduled and reasonably expected unscheduled outages of system elements. “Security” is the ability of the electric systems to withstand sudden disturbances such as electric short circuits or unanticipated loss of system elements. The Reliability Standards are organized by Performance Categories. Certain categories require that the grid operator not only ensure that grid integrity is maintained under certain adverse system conditions (e.g., security), but also that all customers continue to receive electric supply to meet demand (e.g., adequacy). In that case, grid reliability and service reliability would overlap. But there are other levels of performance where security can be maintained without ensuring adequacy.

1.4 Application of N-1, N-1-1, and N-2 Criteria

The CAISO will maintain the system in a safe operating mode at all times. This obligation translates into respecting the Reliability Criteria at all times, for example during normal operating conditions (N-0) the CAISO must protect for all single contingencies (N-1) and common mode (N-2) double line outages. Also, after a single contingency, the CAISO must re-adjust the system to support the loss of the next most stringent contingency. This is referred to as the N-1-1 condition.

The N-1-1 vs N-2 terminology was introduced only as a temporal differentiation between two existing² NERC Category C events. N-1-1 represents NERC Category C3 (“category B contingency, manual system adjustment, followed by another category B contingency”). The N-2 represents NERC Category C5 (“any two circuits of a multiple circuit tower line”) as well as WECC-S2 (for 500 kV only) (“any two circuits in the same right-of-way”) with no manual system adjustment between the two contingencies.

1.5 Performance Criteria

As set forth on the Summary Table of Inputs and Methodology, this LCR Report is based on NERC Performance Level B and Performance Level C criterion. The NERC Standards refer mainly to thermal overloads. However, the CAISO also tests the electric system in regards to the dynamic and reactive margin compliance with the existing WECC standards for the same NERC performance levels. These Performance Levels can be described as follows:

1.5.1 Performance Criteria- Category B

Category B describes the system performance that is expected immediately following the loss of a single transmission element, such as a transmission circuit, a generator, or a transformer.

Category B system performance requires that all thermal and voltage limits must be within their “Applicable Rating,” which, in this case, are the emergency ratings as generally determined by

² NERC Category B and C terminology no longer aligns with the current NERC standards. It is used in this report since the ISO Tariff still uses this terminology that was in effect at the time when the ISO Tariff section was written.

the PTO or facility owner. Applicable Rating includes a temporal element such that emergency ratings can only be maintained for certain duration. Under this category, load cannot be shed in order to assure the Applicable Ratings are met however there is no guarantee that facilities are returned to within normal ratings or to a state where it is safe to continue to operate the system in a reliable manner such that the next element out will not cause a violation of the Applicable Ratings.

1.5.2 Performance Criteria- Category C

The NERC Planning Standards require system operators to “look forward” to make sure they safely prepare for the “next” N-1 following the loss of the “first” N-1 (stay within Applicable Ratings after the “next” N-1). This is commonly referred to as N-1-1. Because it is assumed that some time exists between the “first” and “next” element losses, operating personnel may make any reasonable and feasible adjustments to the system to prepare for the loss of the second element, including, operating procedures, dispatching generation, moving load from one substation to another to reduce equipment loading, dispatching operating personnel to specific station locations to manually adjust load from the substation site, or installing a “Special Protection Scheme” that would remove pre-identified load from service upon the loss of the “next “ element.³ All Category C requirements in this report refer to situations when in real time (N-0) or after the first contingency (N-1) the system requires additional readjustment in order to prepare for the next worst contingency. In this time frame, load drop is not allowed per existing planning criteria.

Generally, Category C describes system performance that is expected following the loss of two or more system elements. This loss of two elements is generally expected to happen simultaneously, referred to as N-2. It should be noted that once the “next” element is lost after the first contingency, as discussed above under the Performance Criteria B, N-1-1 scenario, the event is effectively a Category C. As noted above, depending on system design and expected system impacts, the **planned and controlled** interruption of supply to customers (load shedding), the removal from service of certain generators and curtailment of exports may be utilized to maintain grid “security.”

³ A Special Protection Scheme is typically proposed as an operational solution that does not require additional generation and permits operators to effectively prepare for the next event as well as ensure security should the next event occur. However, these systems have their own risks, which limit the extent to which they could be deployed as a solution for grid reliability augmentation. While they provide the value of protecting against the next event without the need for pre-contingency load shedding, they add points of potential failure to the transmission network. This increases the potential for load interruptions because sometimes these systems will operate when not required and other times they will not operate when needed.

1.5.3 CAISO Statutory Obligation Regarding Safe Operation

The CAISO will maintain the system in a safe operating mode at all times. This obligation translates into respecting the Reliability Criteria at all times, for example during normal operating conditions **A (N-0)** the CAISO must protect for all single contingencies **B (N-1)** and common mode **C5 (N-2)** double line outages. As a further example, after a single contingency the CAISO must readjust the system in order to be able to support the loss of the next most stringent contingency **C3 (N-1-1)**.

Figure 1.5-1 Temporal graph of LCR Category B vs. LCR Category C

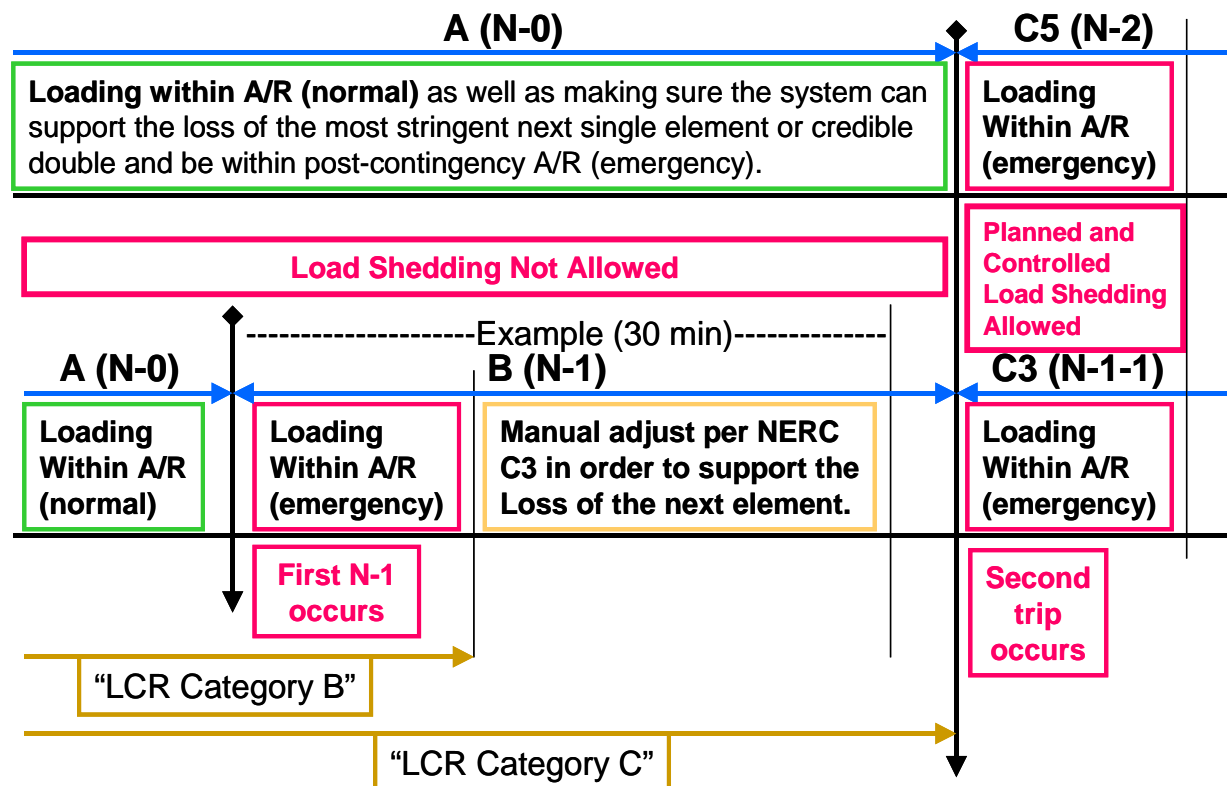

The following definitions guide the CAISO’s interpretation of the Reliability Criteria governing safe mode operation and are used in this LCT Study:

Applicable Rating:

This represents the equipment rating that will be used under certain contingency conditions.

Normal rating is to be used under normal conditions.

Long-term emergency ratings, if available, will be used in all emergency conditions as long as “system readjustment” is provided in the amount of time given (specific to each element) to reduce the flow to within the normal ratings. If not available, the normal rating is to be used.

Short-term emergency ratings, if available, can be used as long as “system readjustment” is provided in the “short-time” available in order to reduce the flow to within the long-term

emergency ratings where the element can be kept for another length of time (specific to each element) before the flow needs to be reduced the below the normal ratings. If not available long-term emergency rating should be used.

Temperature-adjusted ratings shall not be used because this is a year-ahead study, not a real-time tool, and as such the worst-case scenario must be covered. In case temperature-adjusted ratings are the only ratings available then the minimum rating (highest temperature) given the study conditions shall be used.

CAISO Transmission Register is the only official keeper of all existing ratings mentioned above.

Ratings for future projects provided by PTO and agreed upon by the CAISO shall be used.

Other short-term ratings not included in the CAISO Transmission Register may be used as long as they are engineered, studied and enforced through clear operating procedures that can be followed by real-time operators.

Path Ratings need to be maintained within their limits in order to assure that proper capacity is available in order to operate the system in real-time in a safe operating zone.

Controlled load drop:

This is achieved with the use of a Special Protection Scheme.

Planned load drop:

This is achieved when the most limiting equipment has short-term emergency ratings AND the operators have an operating procedure that clearly describes the actions that need to be taken in order to shed load.

Special Protection Scheme:

All known SPS shall be assumed. New SPS must be verified and approved by the CAISO and must comply with the new SPS guideline described in the CAISO Planning Standards.

System Readjustment:

This represents the actions taken by operators in order to bring the system within a safe operating zone after any given contingency in the system.

Actions that can be taken as system readjustment after a single contingency (Category B):

1. System configuration change – based on validated and approved operating procedures
2. Generation re-dispatch
 - a. Decrease generation (up to 1150 MW) – limit given by single contingency SPS as part of the CAISO Grid Planning standards (ISO G4)

- b. Increase generation – this generation will become part of the LCR need

Actions, which shall not be taken as system readjustment after a single contingency (Category B):

1. Load drop – based on the intent of the CAISO/WECC and NERC criteria for category B contingencies.

The NERC Transmission Planning Standards footnote mentions that load shedding can be done after a category B event in certain local areas in order to maintain compliance with performance criteria. However, the main body of the criteria spells out that no dropping of load should be done following a single contingency. All stakeholders and the CAISO agree that no involuntary interruption of load should be done immediately after a single contingency. Further, the CAISO and stakeholders now agree on the viability of dropping load as part of the system readjustment period – in order to protect for the next most limiting contingency. After a single contingency, it is understood that the system is in a Category B condition and the system should be planned based on the body of the criteria with no shedding of load regardless of whether it is done immediately or in 15-30 minute after the original contingency. Category C conditions only arrive after the second contingency has happened; at that point in time, shedding load is allowed in a planned and controlled manner.

A robust California transmission system should be, and under the LCT Study is being, planned based on the main body of the criteria, not the footnote regarding Category B contingencies. Therefore, if there are available resources in the area, they are looked to meet reliability needs (and included in the LCR requirement) before resorting to involuntary load curtailment. The footnote may be applied for criteria compliance issues only where there are no resources available in the area.

Time allowed for manual readjustment:

Tariff Section 40.3.1.1, requires the CAISO, in performing the Local Capacity Technical Study, to apply the following reliability criterion:

Time Allowed for Manual Adjustment: This is the amount of time required for the Operator to take all actions necessary to prepare the system for the next Contingency. The time should not be more than thirty (30) minutes.

The CAISO Planning Standards also impose this manual readjustment requirement. As a parameter of the Local Capacity Technical Study, the CAISO must assume that as the system operator the CAISO will have sufficient time to:

- (1) make an informed assessment of system conditions after a contingency has occurred;
- (2) identify available resources and make prudent decisions about the most effective system redispatch;

(3) manually readjust the system within safe operating limits after a first contingency to be prepared for the next contingency; and

(4) allow sufficient time for resources to ramp and respond according to the operator's redispatch instructions. This all must be accomplished within 30 minutes.

Local capacity resources can meet this requirement by either (1) responding with sufficient speed, allowing the operator the necessary time to assess and redispatch resources to effectively reposition the system within 30 minutes after the first contingency, or (2) have sufficient energy available for frequent dispatch on a pre-contingency basis to ensure the operator can meet minimum online commitment constraints or reposition the system within 30 minutes after the first contingency occurs. Accordingly, when evaluating resources that satisfy the requirements of the CAISO Local Capacity Technical Study, the CAISO assumes that local capacity resources need to be available in no longer than 20 minutes so the CAISO and demand response providers have a reasonable opportunity to perform their respective and necessary tasks and enable the CAISO to reposition the system within the 30 minutes in accordance with applicable reliability criteria.

1.6 The Two Options Presented In This LCT Study Report

This LCT Study sets forth different solution “options” with varying ranges of potential service reliability consistent with CAISO’s Reliability Criteria. The CAISO applies Option 2 for its purposes of identifying necessary local capacity needs and the corresponding potential scope of its backstop authority. Nevertheless, the CAISO continues to provide Option 1 as a point of reference for the CPUC and Local Regulatory Authorities in considering procurement targets for their jurisdictional LSEs.

1.6.1 Option 1 - Meet Performance Criteria Category B

Option 1 is a service reliability level that reflects generation capacity that must be available to comply with reliability standards immediately after a NERC Category B given that load cannot be removed to meet this performance standard under Reliability Criteria. However, this capacity amount implicitly relies on load interruption as the **only means** of meeting any Reliability Criteria that is beyond the loss of a single transmission element (N-1). These situations will likely require substantial load interruptions in order to maintain system continuity and alleviate equipment overloads prior to the actual occurrence of the second contingency.⁴

⁴ This potential for pre-contingency load shedding also occurs because real time operators must prepare for the loss of a common mode N-2 at all times.

1.6.2 Option 2 - Meet Performance Criteria Category C and Incorporate Suitable Operational Solutions

Option 2 is a service reliability level that reflects generation capacity that is needed to readjust the system to prepare for the loss of a second transmission element (N-1-1) using generation capacity *after* considering all reasonable and feasible operating solutions (including those involving customer load interruption) developed and approved by the CAISO, in consultation with the PTOs. Under this option, there is no expected load interruption to end-use customers under normal or single contingency conditions as the CAISO operators prepare for the second contingency. However, the customer load may be interrupted in the event the second contingency occurs.

As noted, Option 2 is the local capacity level that the CAISO requires to reliably operate the grid per NERC, WECC and CAISO standards. As such, the CAISO recommends continuing the adoption of this Option to guide resource adequacy procurement.

2 Assumption Details: How the Study was Conducted

2.1 System Planning Criteria

The following table provides a comparison of system planning criteria, based on the NERC performance standards, used in the study:

Table 2.1-1: Criteria Comparison

Contingency Component(s)	ISO Grid Planning Criteria	Old RMR Criteria	Local Capacity Criteria
<u>A – No Contingencies</u>	X	X	X
<u>B – Loss of a single element</u>			
1. Generator (G-1)	X	X ¹	X ¹
2. Transmission Circuit (L-1)	X	X	X ¹
3. Transformer (T-1)	X	X ²	X ^{1,2}
4. Single Pole (dc) Line	X	X	X ¹
5. G-1 system readjusted L-1	X	X	X
<u>C – Loss of two or more elements</u>			
1. Bus Section	X		
2. Breaker (failure or internal fault)	X		X
3. L-1 system readjusted G-1	X		X
3. G-1 system readjusted T-1 or T-1 system readjusted G-1	X		X
3. L-1 system readjusted T-1 or T-1 system readjusted L-1	X		X
3. G-1 system readjusted G-1	X		X
3. L-1 system readjusted L-1	X		X
3. T-1 system readjusted T-1	X		X
4. Bipolar (dc) Line	X		
5. Two circuits (Common Mode) L-2	X		
6. SLG fault (stuck breaker or protection failure) for G-1	X		
7. SLG fault (stuck breaker or protection failure) for L-1	X		
8. SLG fault (stuck breaker or protection failure) for T-1	X		X
9. SLG fault (stuck breaker or protection failure) for Bus section	X		
WECC-S3. Two generators (Common Mode) G-2	X ³		
<u>D – Extreme event – loss of two or more elements</u>			
Any B1-4 system readjusted (Common Mode) L-2	X ⁴		X ³
All other extreme combinations D1-14.	X ⁴		
¹ System must be able to readjust to a safe operating zone in order to be able to support the loss of the next contingency. ² A thermal or voltage criterion violation resulting from a transformer outage may not be cause for a local area reliability requirement if the violation is considered marginal (e.g. acceptable loss of facility life or low voltage), otherwise, such a violation will necessitate creation of a requirement. ³ Evaluate for risks and consequence, per NERC standards. No voltage collapse or dynamic instability allowed. ⁴ Evaluate for risks and consequence, per NERC standards.			

A significant number of simulations were run to determine the most critical contingencies within each Local Capacity Area. Using power flow, post-transient load flow, and stability assessment tools, the system performance results of all the contingencies that were studied were measured against the system performance requirements defined by the criteria shown in Table 2.1-2. Where the specific system performance requirements were not met, generation was adjusted such that the minimum amount of generation required to meet the criteria was determined in the Local Capacity Area. The following describes how the criteria were tested for the specific type of analysis performed.

2.1.1 Power Flow Assessment:

Table 2.1-3 Power flow criteria

Contingencies	Thermal Criteria ³	Voltage Criteria ⁴
Generating unit ^{1,6}	Applicable Rating	Applicable Rating
Transmission line ^{1,6}	Applicable Rating	Applicable Rating
Transformer ^{1,6}	Applicable Rating ⁵	Applicable Rating ⁵
(G-1)(L-1) ^{2,6}	Applicable Rating	Applicable Rating
Overlapping ^{6,7}	Applicable Rating	Applicable Rating

- ¹ All single contingency outages (i.e. generating unit, transmission line or transformer) will be simulated on Participating Transmission Owners' local area systems.
- ² Key generating unit out, system readjusted, followed by a line outage. This over-lapping outage is considered a single contingency within the ISO Grid Planning Criteria. Therefore, load dropping for an overlapping G-1, L-1 scenario is not permitted.
- ³ Applicable Rating – Based on CAISO Transmission Register or facility upgrade plans including established Path ratings.
- ⁴ Applicable Rating – CAISO Grid Planning Criteria or facility owner criteria as appropriate including established Path ratings.
- ⁵ A thermal or voltage criterion violation resulting from a transformer outage may not be cause for a local area reliability requirement if the violation is considered marginal (e.g. acceptable loss of facility life or low voltage), otherwise, such a violation will necessitate creation of a requirement.
- ⁶ Following the first contingency (N-1), the generation must be sufficient to allow the operators to bring the system back to within acceptable (normal) operating range (voltage and loading) and/or appropriate OTC following the studied outage conditions.
- ⁷ During normal operation or following the first contingency (N-1), the generation must be sufficient to allow the operators to prepare for the next worst N-1 or common mode N-2

without pre-contingency interruptible or firm load shedding. SPS/RAS/Safety Nets may be utilized to satisfy the criteria after the second N-1 or common mode N-2 except if the problem is of a thermal nature such that short-term ratings could be utilized to provide the operators time to shed either interruptible or firm load. T-2s (two transformer bank outages) would be excluded from the criteria.

2.1.2 Post Transient Load Flow Assessment:

Table 2.1-4 Post transient load flow criteria

Contingencies	Reactive Margin Criteria ²
Selected ¹	Applicable Rating

¹ If power flow results indicate significant low voltages for a given power flow contingency, simulate that outage using the post transient load flow program. The post-transient assessment will develop appropriate Q/V and/or P/V curves.

² Applicable Rating – positive margin based on the higher of imports or load increase by 5% for N-1 contingencies, and 2.5% for N-2 contingencies.

2.1.3 Stability Assessment:

Table 2.1-5 Stability criteria

Contingencies	Stability Criteria ²
Selected ¹	Applicable Rating

¹ Base on historical information, engineering judgment and/or if power flow or post transient study results indicate significant low voltages or marginal reactive margin for a given contingency.

² Applicable Rating – CAISO Grid Planning Criteria or facility owner criteria as appropriate.

2.2 Load Forecast

2.2.1 System Forecast

The California Energy Commission (CEC) derives the load forecast at the system and Participating Transmission Owner (PTO) levels. This relevant CEC forecast is then distributed across the entire system, down to the local area, division and substation level. The PTOs use an econometric equation to forecast the system load. The predominant parameters affecting the system load are (1) number of households, (2) economic activity (gross metropolitan products, GMP), (3) temperature and (4) increased energy efficiency and distributed generation programs.

2.2.2 Base Case Load Development Method

The method used to develop the load in the base case is a melding process that extracts, adjusts and modifies the information from the system, distribution and municipal utility forecasts. The melding process consists of two parts: Part 1 deals with the PTO load and Part 2 deals with the municipal utility load. There may be small differences between the methodologies used by each PTO to disaggregate the CEC load forecast to their level of local area as well as bar-bus model.

2.2.2.1 PTO Loads in Base Case

The methods used to determine the PTO loads are, for the most part, similar. One part of the method deals with the determination of the division⁵ loads that would meet the requirements of 1-in-5 or 1-in-10 system or area base cases and the other part deals with the allocation of the division load to the transmission buses.

a. Determination of division loads

The annual division load is determined by summing the previous year division load and the current division load growth. Thus, the key steps are the determination of the initial year division load and the annual load growth. The initial year for the base case development method is based heavily on recorded data. The division load growth in the system base case is determined in two steps. First, the total PTO load growth for the year is determined, as the product of the PTO load and the load growth rate from the system load forecast. Then this total PTO load growth is allocated to the division, based on the relative magnitude of the load growth projected for the divisions by the distribution planners. For example, for the 1-in-10 area base case, the division load growth determined for the system base case is adjusted to the 1-in-10 temperature using the load temperature relation determined from the latest peak load and temperature data of the division.

b. Allocation of division load to transmission bus level

Since the loads in the base case are modeled at the various transmission buses, the division loads developed must be allocated to those buses. The allocation process is different depending on the load types. For the most part, each PTO classifies its loads into four types: conforming, non-conforming, self-generation and generation-plant loads. Since the non-conforming and self-generation loads are assumed to not vary with temperature, their magnitude would be the same in the system or area base cases of the same year. The remaining load (the total division load developed above, less the quantity of non-conforming and self-generation load) is the conforming load. The remaining load is allocated to the transmission buses based on the relative magnitude of the distribution forecast. The summation of all base case loads is generally higher than the load forecast because some load, i.e., self-generation and generation-plant, are behind the meter and must be modeled in the base cases. However, for the most part, metered or aggregated data with telemetry is used to come up with the load forecast.

⁵ Each PTO divides its territory in a number of smaller area named divisions. These are usually smaller and compact areas that have the same temperature profile.

2.2.2.2 *Municipal Loads in Base Case*

The municipal utility forecasts that have been provided to the CEC and PTOs for the purposes of their base cases were also used for this study.

2.3 Power Flow Program Used in the LCR analysis

The technical studies were conducted using General Electric's Power System Load Flow (GE PSLF) program version 21.05 and PowerGem's Transmission Adequacy and Reliability Assessment (TARA) program version 1702. This GE PSLF program is available directly from GE or through the Western System Electricity Council (WECC) to any member and TARA program is commercially available.

To evaluate Local Capacity Areas, the starting base case was adjusted to reflect the latest generation and transmission projects as well as the one-in-ten-year peak load forecast for each Local Capacity Area as provided to the CAISO by the PTOs.

Electronic contingency files provided by the PTOs were utilized to perform the numerous contingencies required to identify the LCR. These contingency files include remedial action and special protection schemes that are expected to be in operation during the year of study. A CAISO created EPCL (a GE programming language contained within the GE PSLF package) routine and/or TARA software were used to run the combination of contingencies; however, other routines are available from WECC with the GE PSFL package or can be developed by third parties to identify the most limiting combination of contingencies requiring the highest amount of generation within the local area to maintain power flows within applicable ratings.

3 Locational Capacity Requirement Study Results

3.4 Summary of Study Results

LCR is defined as the amount of resource capacity that is needed within a Local Capacity Area to reliably serve the load located within this area. The results of the CAISO's analysis are summarized in the Executive Summary Tables.

Table 3.4-1 2028 Local Capacity Needs vs. Peak Load and Local Area Resources

	2028 Total LCR (MW)	Peak Load (1 in10) (MW)	2028 LCR as % of Peak Load	Total Dependable Local Area Resources (MW)	2028 LCR as % of Total Area Resources
Humboldt	170	185	92%	202	84%
North Coast/North Bay	883	1587	56%	855	103%**
Sierra	1510	1940	78%	2150	70%
Stockton	537	1153	47%	684	79%**
Greater Bay	5600	11146	50%	7611	74%**
Greater Fresno	1728	3496	49%	3508	49%
Kern	140	1393	10%	475	29%**
LA Basin	6590	19625	34%	8284	80%
Big Creek/Ventura	2245	5031	45%	3511	64%**
San Diego/Imperial Valley	3908	4671	84%	4508	87%
Total	23311	50227*	46%*	31788	73%

Table 3.4-2 2023 Local Capacity Needs vs. Peak Load and Local Area Resources

	2023 Total LCR (MW)	Peak Load (1 in10) (MW)	2023 LCR as % of Peak Load	Total Dependable Local Area Resources (MW)	2023 LCR as % of Total Area Resources
Humboldt	169	188	90%	202	84%
North Coast/North Bay	553	1524	36%	890	62%
Sierra	1924	1822	106%	2150	89%
Stockton	439	1227	36%	684	64%**
Greater Bay	4752	10441	46%	7054	67%
Greater Fresno	1688	3231	52%	3509	48%
Kern	182	1140	16%	475	38%**
LA Basin	6793	20072	34%	8311	82%
Big Creek/Ventura	2792	5169	54%	3507	80%**
San Diego/Imperial Valley	4132	4554	91%	4487	92%
Total	23424	49368*	47%*	31269	75%

* Value shown only illustrative, since each local area peaks at a different time.

** Resource deficient LCA (or with sub-area that are deficient) – deficiency included in LCR. Resource deficient area implies that in order to comply with the criteria, at summer peak, load must be shed immediately after the first contingency.

Table 3.4-1 and Table 3.4-2 shows how much of the Local Capacity Area load is dependent on local resources and how many local resources must be available in order to serve the load in those Local Capacity Areas in a manner consistent with the Reliability Criteria. These tables also indicate where new transmission projects, new resource additions or demand side management programs would be most useful in order to reduce the dependency on existing, generally older and less efficient local area resources.

The term “Qualifying Capacity” used in this report is the “Net Qualifying Capacity” (“NQC”) posted on the CAISO web site at:

<http://www.caiso.com/planning/Pages/ReliabilityRequirements/Default.aspx>

The NQC list includes the area (if applicable) where each resource is located for units already operational. Neither the NQC list nor this report incorporates Demand Side Management

programs and their related NQC. Units scheduled to become operational before June 1 of 2028 have been included in this 2028 Long-Term LCR Report and added to the total NQC values for those respective areas (see detail write-up for each area).

Regarding the main tables up front (page 2), the first column, “Qualifying Capacity,” reflects two sets of resources. The first set is comprised of resources that would normally be expected to be on-line such as Municipal and Regulatory Must-take resources (state, federal, QFs, wind and nuclear units). The second set is “market” resources. The second column, “YEAR LCR Requirement Based on Category B” identifies the local capacity requirements, and deficiencies that must be addressed, in order to achieve a service reliability level based on Performance Criteria- Category B. The third column, “YEAR LCR Requirement Based on Category C with Operating Procedure”, sets forth the local capacity requirements, and deficiencies that must be addressed, necessary to attain a service reliability level based on Performance Criteria-Category C with operational solutions.

3.5 Summary of Results by Local Area

Each Local Capacity Area's overall requirement is determined by also achieving each sub-area requirement. Because these areas are a part of the interconnected electric system, the total for each Local Capacity Area is not simply a summation of the sub-area needs. For example, some sub-areas may overlap and therefore the same units may count for meeting the needs in both sub-areas.

3.5.1 Humboldt Area

3.5.1.1 Area Definition:

The transmission tie lines into the area include:

- Bridgeville-Cottonwood 115 kV line #1
- Humboldt-Trinity 115 kV line #1
- Laytonville-Garberville 60 kV line #1
- Trinity-Maple Creek 60 kV line #1

The substations that delineate the Humboldt Area are:

- Bridgeville is in, Low Gap, Wildwood and Cottonwood are out
- Humboldt is in, Trinity is out
- Kekawaka and Garberville are in, Laytonville is out
- Maple Creek is in, Trinity and Ridge Cabin are out

3.5.1.1.1 Humboldt LCR Area Diagram

Figure 3.5-1 Humboldt LCR Area

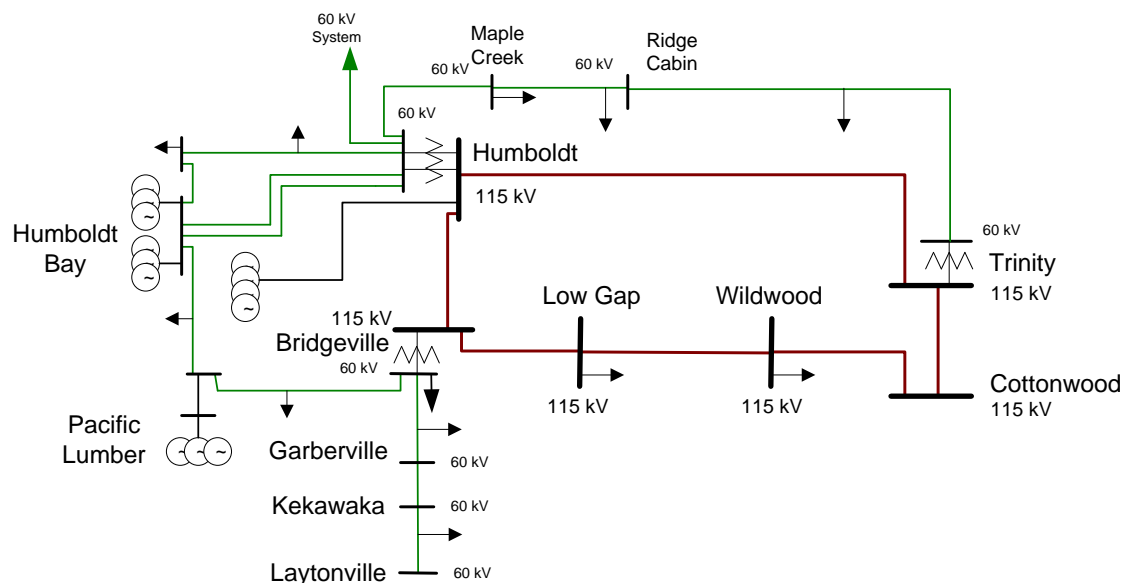

3.5.1.1.2 Humboldt LCR Area Load and Resources

Table 3.5-1 provides the forecast load and resources in the Humboldt LCR Area in 2028. The list of generators within the LCR area are provided in Attachment A.

Table 3.5-1 Humboldt LCR Area 2028 Forecast Load and Resources

Load (MW)		Generation (MW)	
Gross Load	183	Market Gas	163
AAEE	-9	Other Gas	13
Behind the meter DG	0	Non-Gas	26
Net Load	174		
Transmission Losses	11		
Pumps	0	Total Qualifying Capacity	202
Load + Losses + Pumps	185		

3.5.1.1.3 Humboldt LCR Area Hourly Profiles

Figure 3.5-2 illustrates the forecast 2028 profile for the summer peak, winter peak and spring off-peak days for the Humboldt LCR area with the Category C (Multiple Contingency) transmission capability with no market gas. Figure 3.5-3 illustrates the forecast 2028 hourly profile for Humboldt LCR area with the Category C (Multiple Contingency) transmission capability with no market gas.

Figure 3.5-2 Humboldt 2028 Peak Day Forecast Profiles

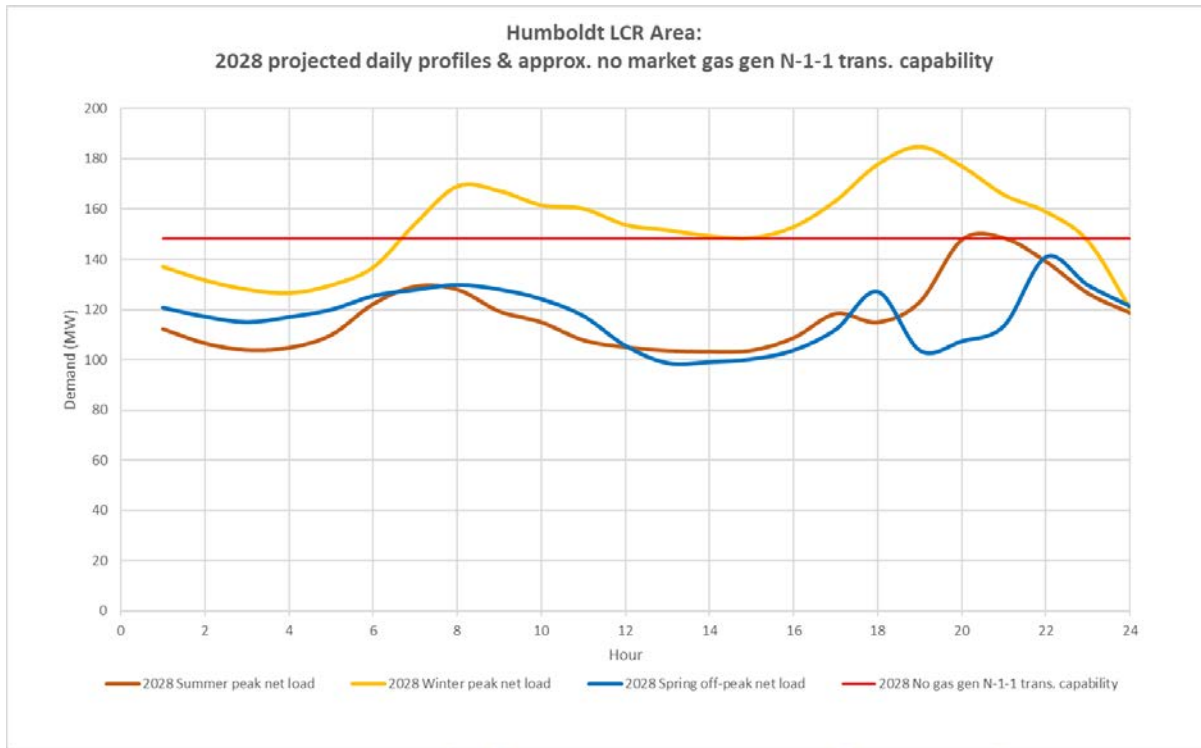
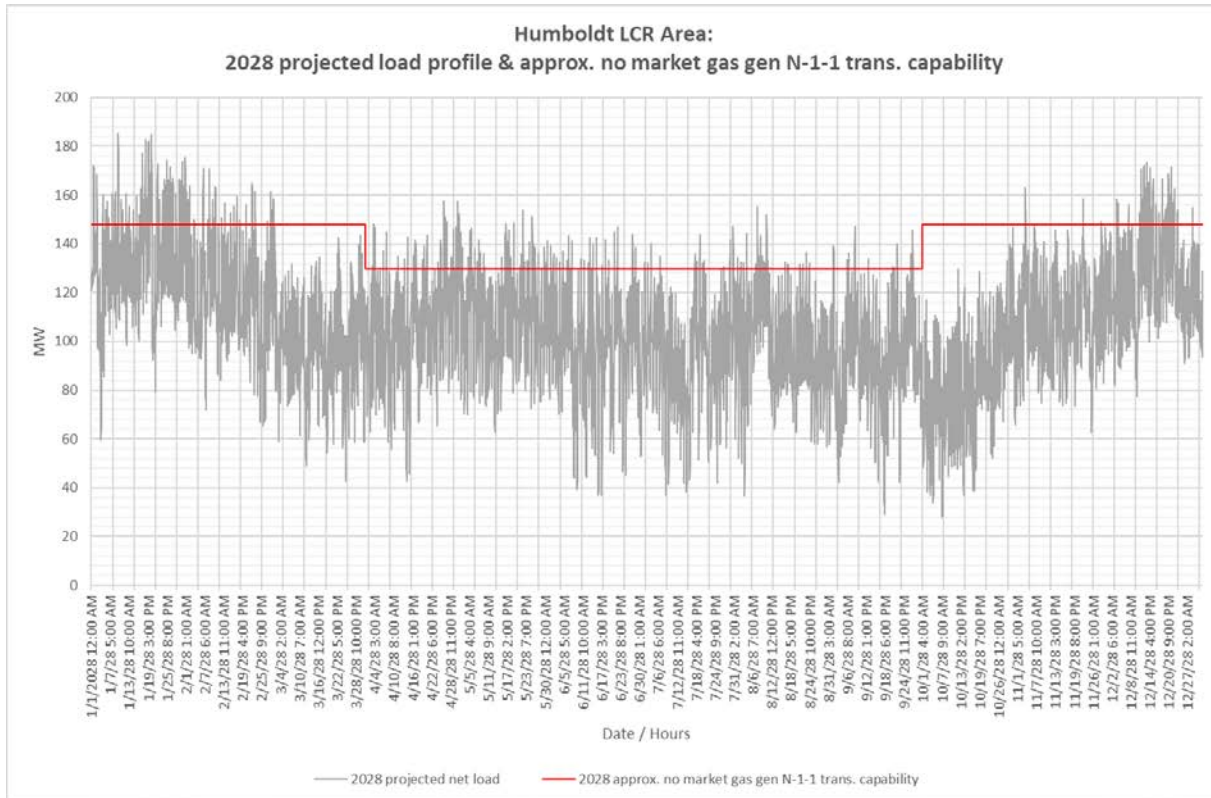

Figure 3.5-3 Humboldt 2028 Forecast Hourly Profile



3.5.1.1.4 Approved transmission projects included in base cases

1. Maple Creek Reactive Support
2. Garberville Reactive Support
3. Bridgeville 115/60 kV #1 transformer replacement

3.5.1.2 Humboldt Overall LCR Requirement

Table 3.5-2 identifies the limiting facility and contingency that establishes the Humboldt 2028 LCR requirements. The LCR requirement for Category B (Single Contingency) is 117 MW and for Category C (Multiple Contingency) is 170 MW.

Table 3.5-2 Humboldt LCR Area Requirements

Year	Limit	Category	Limiting Facility	Contingency	LCR (MW) (Deficiency)
2028	First Limit	B ⁶	Humboldt-Trinity 115 kV	Cottonwood-Bridgeville 11 5kV line with one of the Humboldt Bay units	117
2028	First Limit	C ⁷	Humboldt-Trinity 115 kV	Cottonwood-Bridgeville 115 kV & Humboldt - Humboldt Bay 115 kV	170

3.5.1.2.1 Effectiveness factors:

For most helpful procurement information please read procedure 2210Z Effectiveness Factors under 7110 (T-138Z) posted at: <http://www.caiso.com/Documents/2210Z.pdf>

3.5.1.2.2 Changes compared to last year's results:

Compared with 2023 the load forecast decreased by 3 MW and the total LCR has increased by 1 MW.

⁶ LCR requirement for a single contingency means that there wouldn't be any criteria violations following the loss of a single element, however the operators will not have any means (other than load drop) in order to bring the system within a safe operating zone and get prepared for the next contingency as required by NERC transmission operations standards.

⁷ LCR requirement for multiple contingencies means that not only there wouldn't be any criteria violations following the loss of a single element, but also the operators will have enough generation (other operating procedures) in order to bring the system within a safe operating zone and get prepared for the next contingency as required by NERC transmission operations standards.

3.5.1.2.3 Alternatives to Reduce or Eliminate Gas Generation

As a part of the 2018-2019 transmission planning process the ISO undertook an assessment in approximately half of the LCR areas and LCR Sub-areas to determine potential transmission alternatives to reduce or eliminate the need for gas-fired generation to meet the LCR requirement. In the 2018-2019 transmission planning process the Humboldt LCR Area was not selected to assess alternatives to reduce or eliminate the requirement for gas-fired generation to address the LCR requirement.

3.5.2 North Coast / North Bay Area

3.5.2.1 *Area Definition:*

The transmission tie facilities coming into the North Coast/North Bay area are:

- Cortina-Mendocino 115 kV Line
- Cortina-Eagle Rock 115 kV Line
- Willits-Garberville 60 kV line #1
- Vaca Dixon-Lakeville 230 kV line #1
- Tulucay-Vaca Dixon 230 kV line #1
- Lakeville-Sobrante 230 kV line #1
- Ignacio-Sobrante 230 kV line #1

The substations that delineate the North Coast/North Bay area are:

- Cortina is out, Mendocino and Indian Valley are in
- Cortina is out, Eagle Rock, Highlands and Homestake are in
- Willits and Lytonville are in, Kekawaka and Garberville are out
- Vaca Dixon is out, Lakeville is in
- Tulucay is in, Vaca Dixon is out
- Lakeville is in, Sobrante is out
- Ignacio is in, Sobrante and Crocket are out

3.5.2.1.1 North Coast and North Bay LCR Area Diagram

Figure 3.5-4 North Coast and North Bay LCR Area

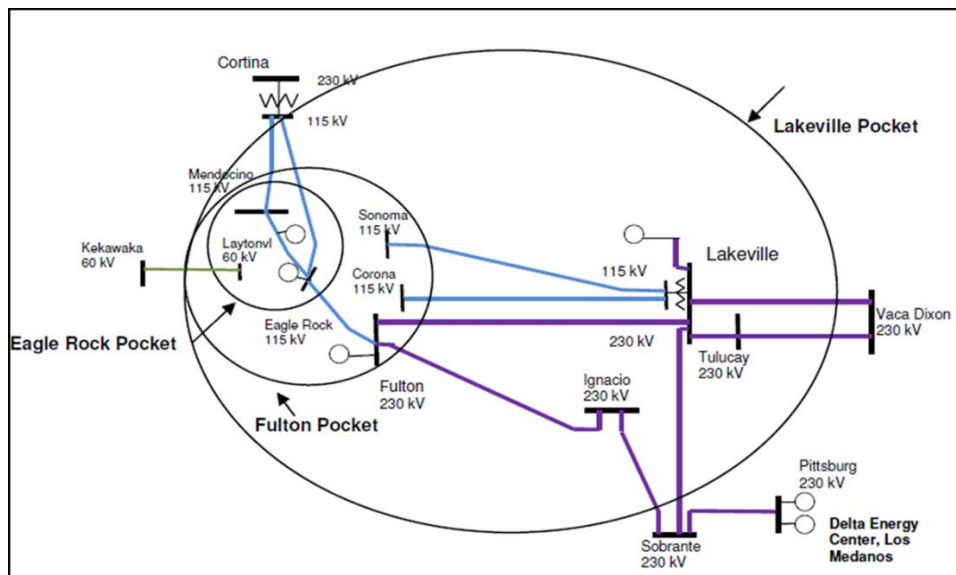

3.5.2.1.2 North Coast and North Bay LCR Area Load and Resources

Table 3.5-3 provides the forecast load and resources in the North Coast and North Bay LCR Area in 2028. The list of generators within the LCR area are provided in Attachment A.

Table 3.5-3 North Coast and North Bay LCR Area 2028 Forecast Load and Resources

Load (MW)		Generation (MW)	
Gross Load	1627	Market Gas	0
AAEE	-89	Other Gas	0
Behind the meter DG	0	Non-Gas	850
Net Load	1538		
Transmission Losses	49	QF	5
Pumps	0	Total Qualifying Capacity	855
Load + Losses + Pumps	1587		

3.5.2.1.3 North Coast and North Bay LCR Area Hourly Profiles

Figure 3.5-5 illustrates the forecast 2028 profile for the summer peak, winter peak and spring off-peak days for the North Coast and North Coast LCR area with the Category C (Multiple Contingency) transmission capability with no market gas. Figure 3.5-6 illustrates the forecast 2028 hourly profile for North Coast and North Bay LCR area with the Category C (Multiple Contingency) transmission capability with no market gas.

Figure 3.5-5 North Coast and North Bay 2028 Peak Day Forecast Profiles

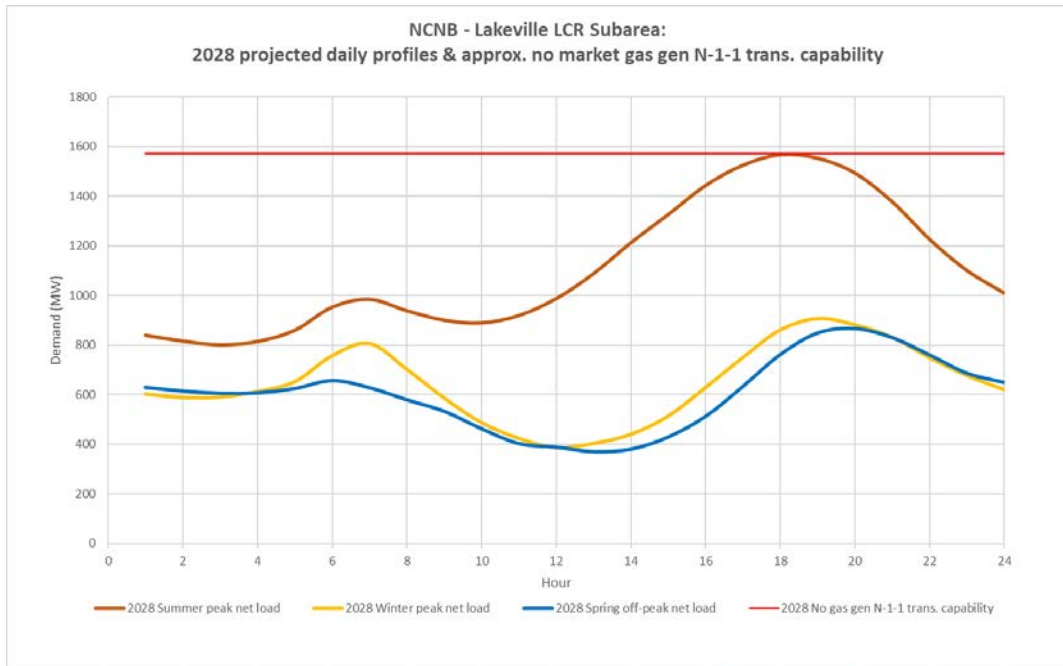
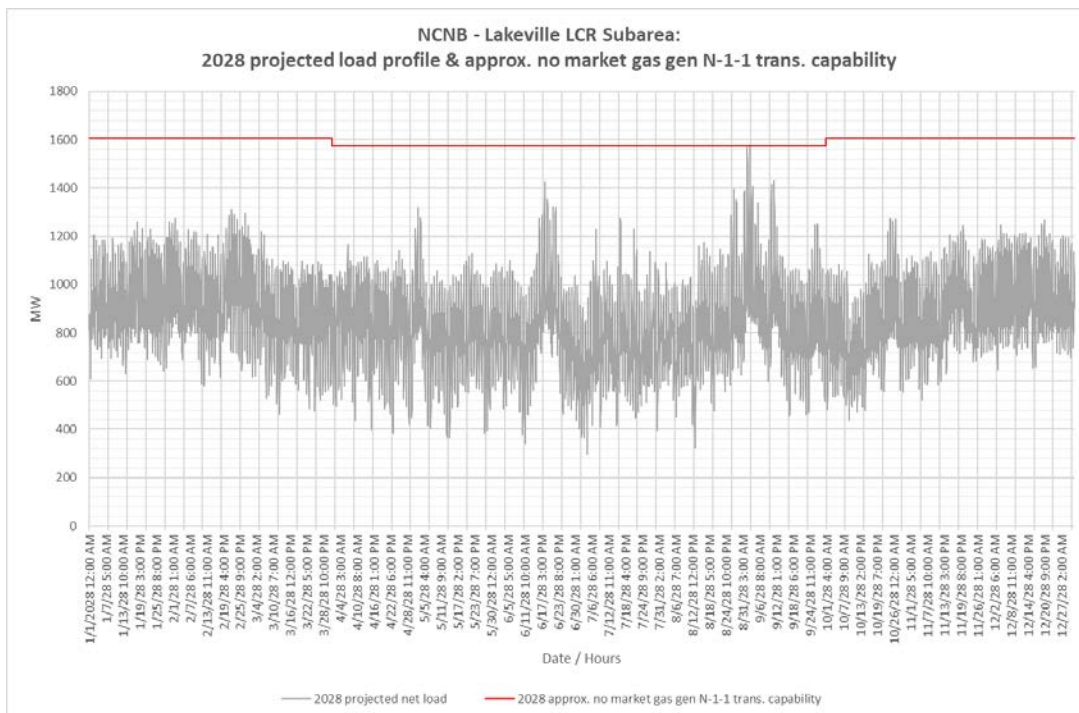

Figure 3.5-6 North Coast and North Bay 2028 Forecast Hourly Profile



3.5.2.1.4 Approved transmission projects modeled in base cases

- Vaca Dixon-Lakeville 230 kV Corridor Series Compensation
- Fulton-Fitch Mountain 60 kV Line Reconductor
- Clear Lake 60 kV System Reinforcement
- Ignacio-Alta 60 kV Line Conversion
- Lakeville 60 kV Area Reinforcement

3.5.2.2 **Eagle Rock LCR Sub-area**

Eagle Rock is a Sub-area of the North Coast and North Bay LCR Area.

3.5.2.2.1 Eagle Rock LCR Sub-area Diagram

Figure 3.5-7 Eagle Roc LCR Sub-area

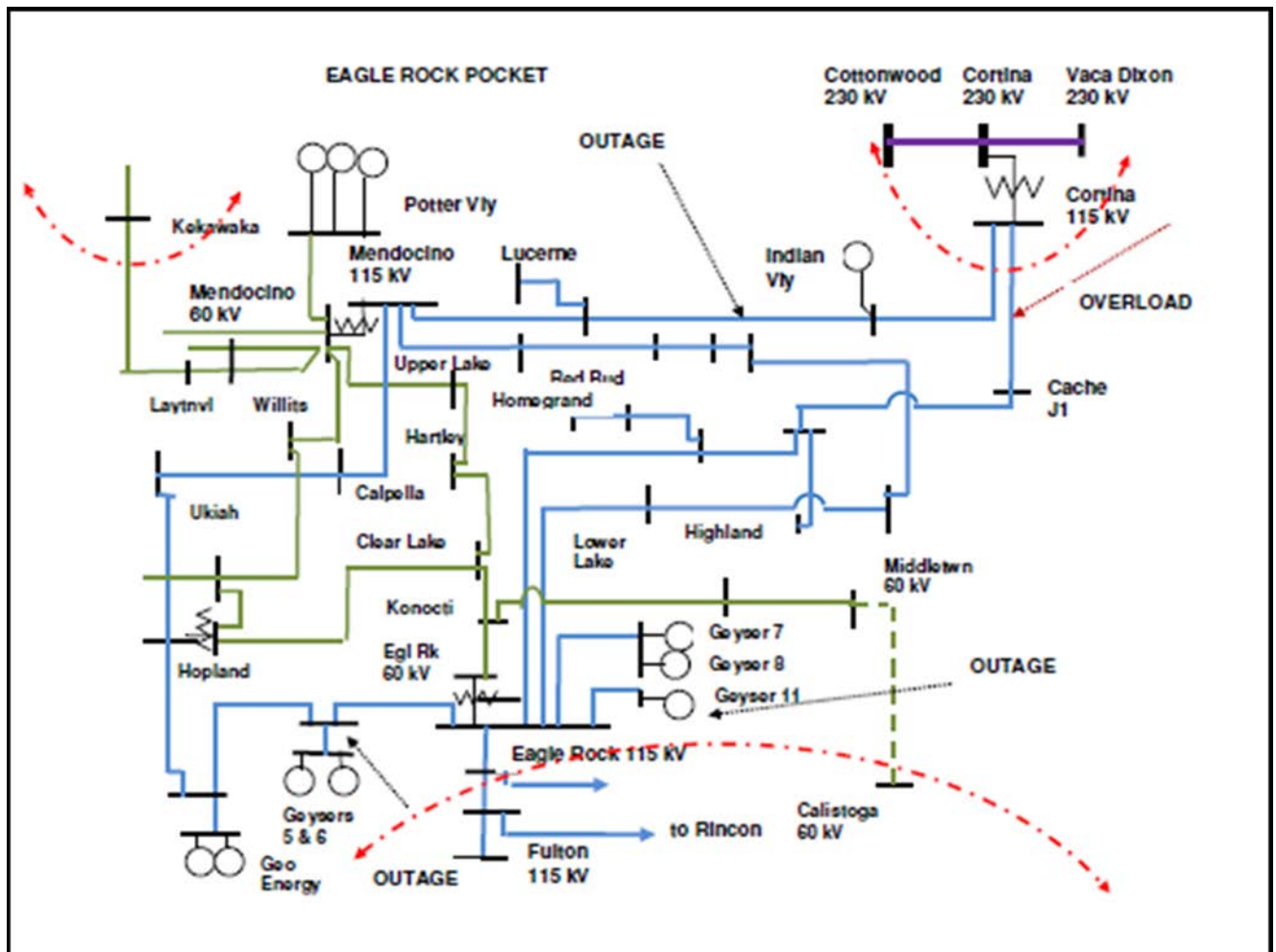

3.5.2.2.2 Eagle Rock LCR sub-area Load and Resources

Table 3.5-4 provides the forecast load and resources in Eagle Rock LCR Sub-area in 2028. The list of generators within the LCR Sub-area are provided in Attachment A.

Table 3.5-4 Eagle Rock LCR Area 2028 Forecast Load and Resources

Load (MW)		Generation (MW)	
Gross Load		Market Gas	
AAEE		Other Gas	
Behind the meter DG		Non-Gas	
Net Load			
Transmission Losses		QF	
Pumps		Total Qualifying Capacity	
Load + Losses + Pumps			

3.5.2.2.3 Eagle Rock LCR Sub-area Hourly Profiles

Figure 3.5-8 illustrates the forecast 2028 profile for the summer peak, winter peak and spring off-peak days for the North Coast and North Coast LCR area with the Category C (Multiple Contingency) transmission capability with no market gas. Figure 3.5-6 illustrates the forecast 2028 hourly profile for North Coast and North Bay LCR area with the Category C (Multiple Contingency) transmission capability with no market gas.

Figure 3.5-8 Eagle Rock LCR Sub-area 2028 Peak Day Forecast Profiles

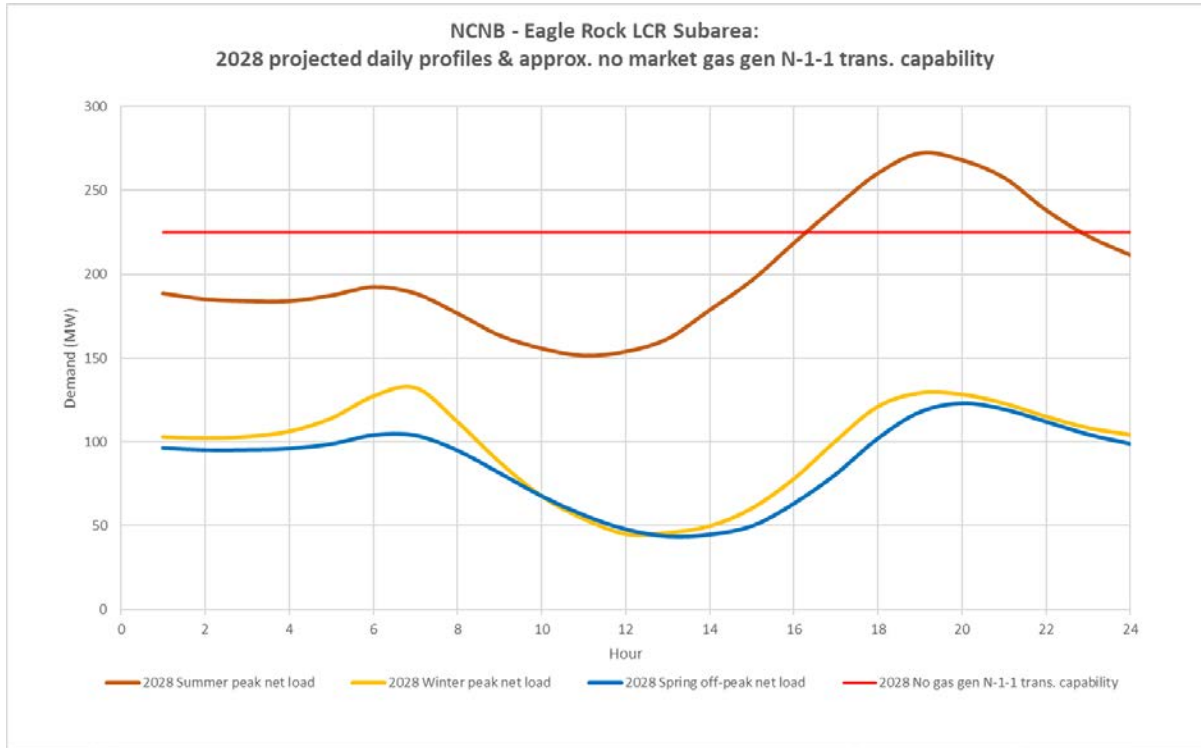
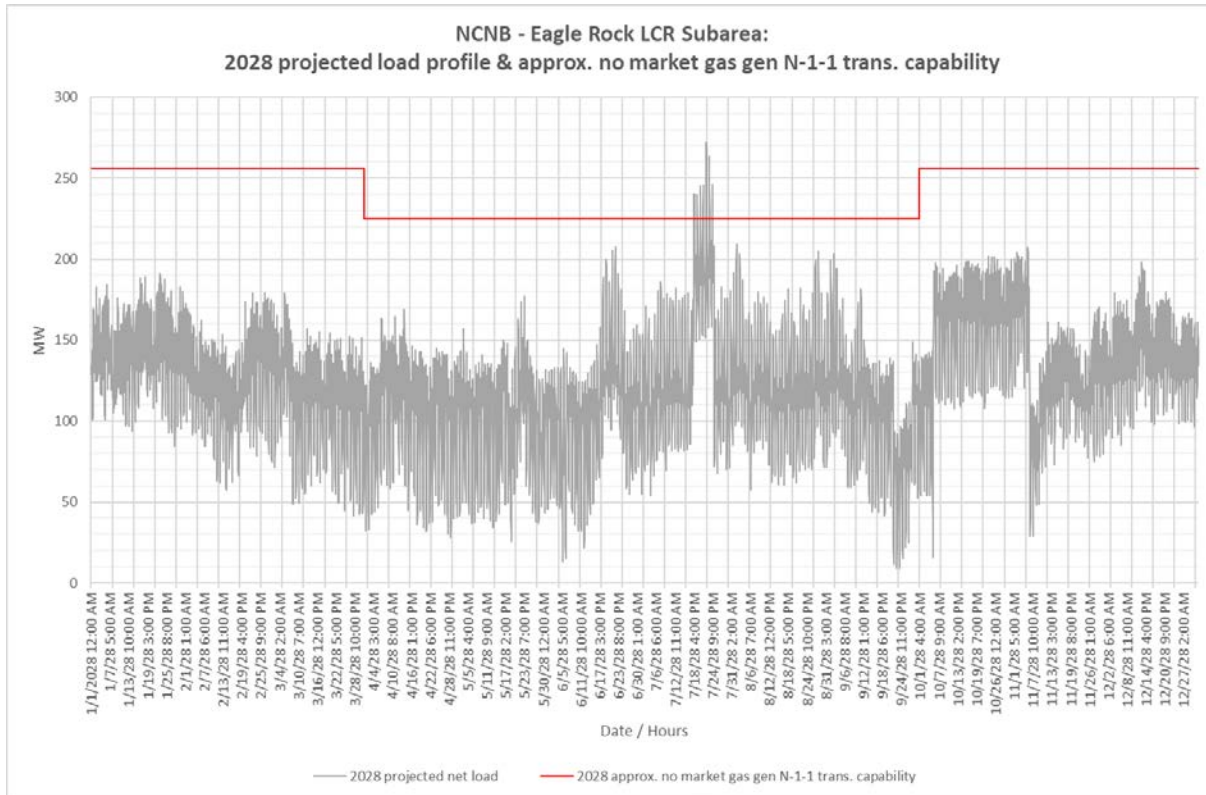

Figure 3.5-9 Eagle Rock LCR Sub-area 2028 Forecast Hourly Profiles



3.5.2.2.4 Eagle Rock LCR Sub-area Requirement

Table 3.5-5 identifies the Eagle Rock 2028 LCR Sub-area requirements. The LCR requirement for Category B (Single Contingency) is 276 MW with a 26 MW deficiency and for Category C (Multiple Contingency) is 278 MW with a 28 MW deficiency.

Table 3.5-5 Eagle Rock LCR Sub-area Requirements

Year	Limit	Category	Limiting Facility	Contingency	LCR (MW) (Deficiency)
2028	First Limit	B	Eagle Rock-Cortina 115 kV line	Cortina-Mendocino 115 kV with Geysers #11 unit out	276 (26)
2028	First Limit	C	Eagle Rock-Cortina 115 kV line	Cortina-Mendocino 115 kV & Geysers #3-Geysers #5 115 kV	278 (28)

3.5.2.2.5 Effectiveness factors:

Effectiveness factors for generators in the Eagle Rock LCR Sub-area are in Attachment B table titled [Eagle Rock](#).

For most helpful procurement information please read procedure 2210Z Effectiveness Factors under 7110 (T-138Z) posted at: <http://www.caiso.com/Documents/2210Z.pdf>

3.5.2.2.6 Alternatives to Reduce or Eliminate Gas Generation

As a part of the 2018-2019 transmission planning process the ISO undertook an assessment in approximately half of the LCR areas and LCR Sub-areas to determine potential transmission alternatives to reduce or eliminate the need for gas-fired generation to meet the LCR requirement. In the 2018-2019 transmission planning process the Eagle Rock LCR Sub-Area was not selected to assess alternatives to reduce or eliminate the requirement for gas-fired generation to address the LCR requirement.

3.5.2.3 Fulton Sub-area

Fulton is a Sub-area of the North Coast and North Bay LCR Area. The 2028 LCT study identified that the Fulton Sub-area will no longer be required due to Lakeville #2 60 kV line (Lakeville-Petaluma-Cotati 60 kV) being permanently open.

3.5.2.4 *Lakeville Sub-area (North Coast and North Bay Overall)*

Lakeville is a Sub-area of the North Coast and North Bay LCR Area and as illustrated in Figure 3.2-4 the Lakeville area now represent the North Coast and North Bay LCR overall requirement.

3.5.2.4.1 Lakeville Sub-area LCR Sub-area Diagram

As illustrated in Figure 3.5-4 the Lakeville area now represent the North Coast and North Bay LCR overall requirement.

3.5.2.4.2 Lakeville Sub-area LCR Sub-area Hourly Profiles

The Lakeville Sub-area represents the North Coast and North Bay overall LCR area with the profiles being as illustrated in Figure 3.5-5 and Figure 3.5-6

3.5.2.4.3 Lakeville LCR Sub-area Load and Resources

The Lakeville Sub-area represents the North Coast and North Bay overall LCR area with the load and resources are as identified in Table 3.5-3. The list of generators within the LCR Sub-area are provided in Attachment A.

3.5.2.4.4 Lakeville LCR Sub-area (North Coast and North Bay Overall) Requirement

Table 3.5-2 Table 3.5-6 identifies the limiting facility and contingency that establishes the Lakeville Sub-area and the North Coast and North Bay LCR area overall 2028 LCR requirements. The LCR requirement for Category B (Single Contingency) is 881 MW with a 26 MW deficiency and for Category C (Multiple Contingency) is 883 MW with a 28 MW deficiency.

Table 3.5-6 Lakville LCR Sub-area and North Coast and North Bay LCR area Requirements

Year	Limit	Category	Limiting Facility	Contingency	LCR (MW) (Deficiency)
2028	First Limit	B	Eagle Rock-Cortina 115 kV	Cortina-Mendocino 115 kV with Geysers #11 unit out of service	881 (26)
2028	First Limit	C	Eagle Rock-Cortina 115 kV	Cortina-Mendocino 115 kV & Geysers #3-Geysers #5 115 kV	883 (28)

3.5.2.4.5 Effectiveness factors:

Effectic factors for generators in the Lakeville LCR Sub-area and North Coast and North Bay LCR

area are in Attachment B table titled [Lakeville](#).

For most helpful procurement information please read procedure 2210Z Effectiveness Factors under 7110 (T-138Z) posted at: <http://www.caiso.com/Documents/2210Z.pdf>

3.5.2.4.6 Changes compared to 2023 LCT study

Overall the load forecast went up by 63 MW compared to 2023. The overall LCR requirement went up by 330 MW as a result of load increase in the Eagle Rock sub-area. This load has much higher effectiveness factor against the main constraint than additional resources required to mitigate the same constraint from Fulton and Lakeville sub-areas.

3.5.2.4.7 Alternatives to Reduce or Eliminate Gas Generation

As a part of the 2018-2019 transmission planning process the ISO undertook an assessment in approximately half of the LCR areas and LCR Sub-areas to determine potential transmission alternatives to reduce or eliminate the need for gas-fired generation to meet the LCR requirement. In the 2018-2019 transmission planning process the Lakeville or North Coast and North Bay LCR Area was not selected to assess alternatives to reduce or eliminate the requirement for gas-fired generation to address the LCR requirement. Furthermore there are no gas resources in the North Coast/North Bay area.

3.5.3 Sierra Area

3.5.3.1 Area Definition:

The transmission tie lines into the Sierra Area are:

- Table Mountain-Rio Oso 230 kV line
- Table Mountain-Palermo 230 kV line
- Table Mt-Pease 60 kV line
- Caribou-Palermo 115 kV line
- Drum-Summit 115 kV line #1
- Drum-Summit 115 kV line #2
- Spaulding-Summit 60 kV line
- Brighton-Bellota 230 kV line
- Rio Oso-Lockeford 230 kV line
- Gold Hill-Eight Mile Road 230 kV line
- Lodi-Eight Mile Road 230 kV line
- Gold Hill-Lake 230 kV line

The substations that delineate the Sierra Area are:

- Table Mountain is out Rio Oso is in
- Table Mountain is out Palermo is in
- Table Mt is out Pease is in
- Caribou is out Palermo is in
- Drum is in Summit is out
- Drum is in Summit is out
- Spaulding is in Summit is out
- Brighton is in Bellota is out
- Rio Oso is in Lockeford is out
- Gold Hill is in Eight Mile is out
- Lodi is in Eight Mile is out
- Gold Hill is in Lake is out

3.5.3.1.1 Sierra LCR Area Diagram

Figure 3.5-10 Sierra LCR Area

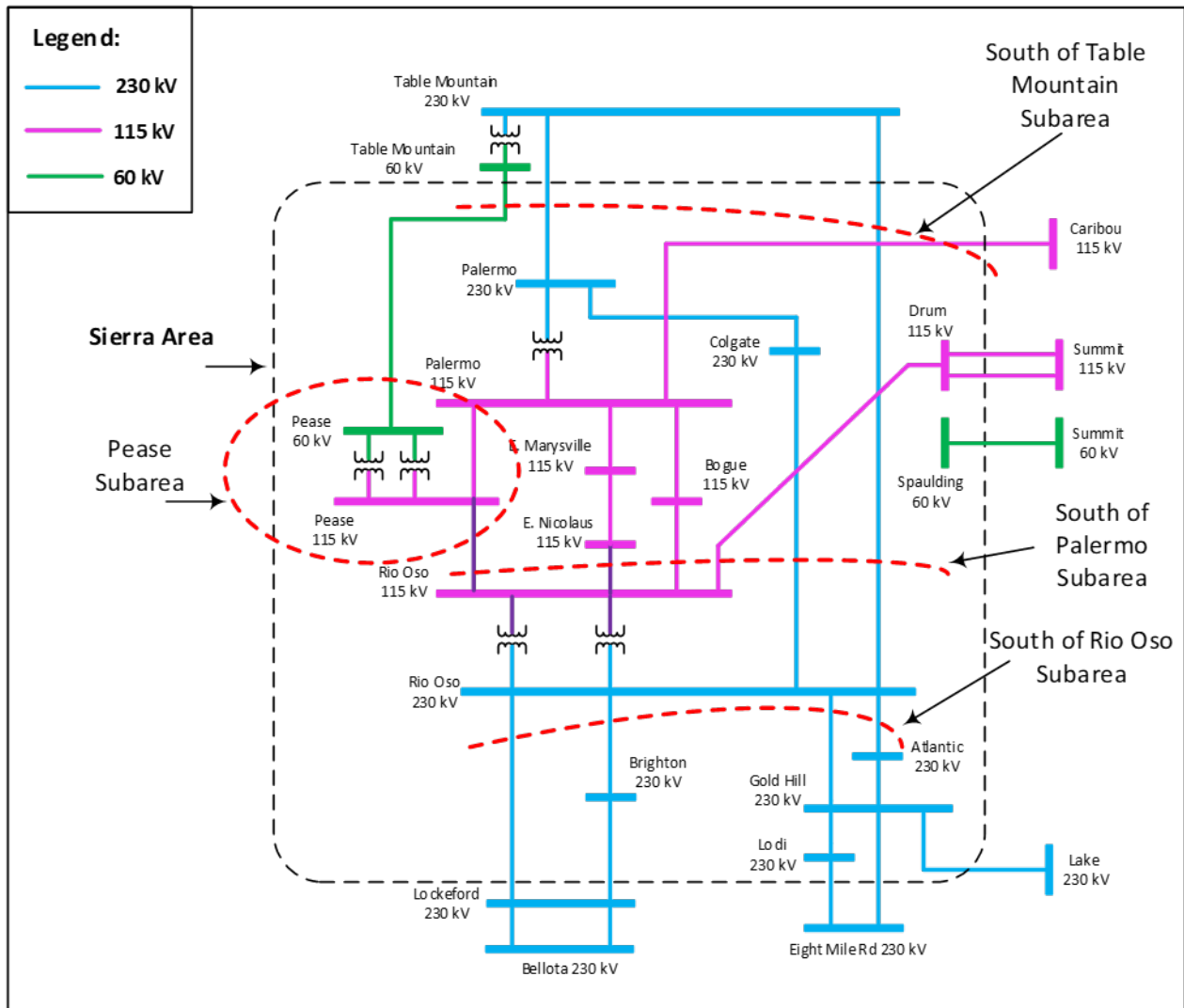

3.5.3.1.2 Sierra LCR Area Load and Resources

Table 3.5-7 provides the forecast load and resources in the Sierra LCR Area in 2028. The list of generators within the LCR area are provided in Attachment A.

Table 3.5-7 Sierra LCR Area 2028 Forecast Load and Resources

Load (MW)		Generation (MW)	
Gross Load	1974	Market Gas	258
AAEE	-117	Other Gas	330
Behind the meter DG	0	Non-Gas	1524
Net Load	1856		
Transmission Losses	84	QF	38
Pumps	0	Total Qualifying Capacity	2150
Load + Losses + Pumps	1940		

3.5.3.1.3 Approved transmission projects modeled:

- Gold Hill-Missouri Flat #1 and #2 115 kV line reconductoring
- Rio Oso #1 and #2 230/115 kV transformer replacement
- Pease 115/60 kV transformer addition
- South of Palermo 115 kV Reinforcement
- Vaca-Davis Area Reinforcement
- Rio Oso Area 230 kV Voltage Support
- Atlantic-Placer 115 kV Line Project

3.5.3.2 *Placerville Sub-area*

Placerville is a Sub-area of the Sierra LCR Area. The 2028 LCT study identified that the Placerville Sub-area will no longer be required due to the Missouri Flat-Gold Hill 115 kV lines reconductoring project being in-service.

3.5.3.3 *Placer Sub-area*

Placer is Sub-area of the Sierra LCR Area. The 2028 LCT study identified that the Placer Sub-area will no longer be required due to the Atlantic-Placer 115 kV Line project being in-service.

3.5.3.4 *Pease Sub-area*

Pease is Sub-area of the Sierra LCR Area.

3.5.3.4.1 Pease LCR Sub-area Diagram

Figure 3.5-11 Pease LCR Sub-area

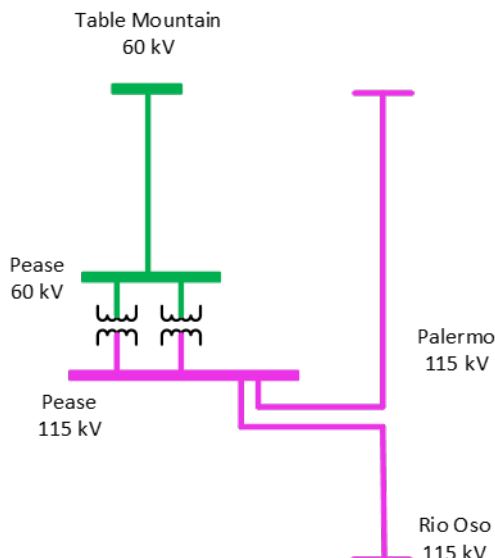

3.5.3.4.2 Pease LCR Sub-area Load and Resources

Table 3.5-8 provides the forecast load and resources in Pease LCR Sub-area in 2028. The list of generators within the LCR Sub-area are provided in Attachment A.

Table 3.5-8 Pease LCR Sub-area 2028 Forecast Load and Resources

Load (MW)		Generation (MW)	
Gross Load	179	Market Gas	98 ⁸
AAEE	-11	Other Gas	36
Behind the meter DG	0	Non-Gas	0
Net Load	168		
Transmission Losses	1		
Pumps	0	Total Qualifying Capacity	134
Load + Losses + Pumps	169		

3.5.3.4.3 Pease LCR Sub-area Hourly Profiles

Figure 3.5-12 illustrates the forecast 2028 profile for the summer peak, winter peak and spring off-peak days for the Pease LCR Sub-area with the Category C (Multiple Contingency) transmission

⁸ The 98 MW Market Gas generation includes the Yuba City Energy Center (YCEC) unit with NQC of 47.6 MW.

capability with no market gas. Figure 3.5-13 illustrates the forecast 2028 hourly profile for Pease LCR Sub-area with the Category C (Multiple Contingency) transmission capability with no market gas.

Figure 3.5-12 Pease LCR Sub-area 2028 Peak Day Forecast Profiles

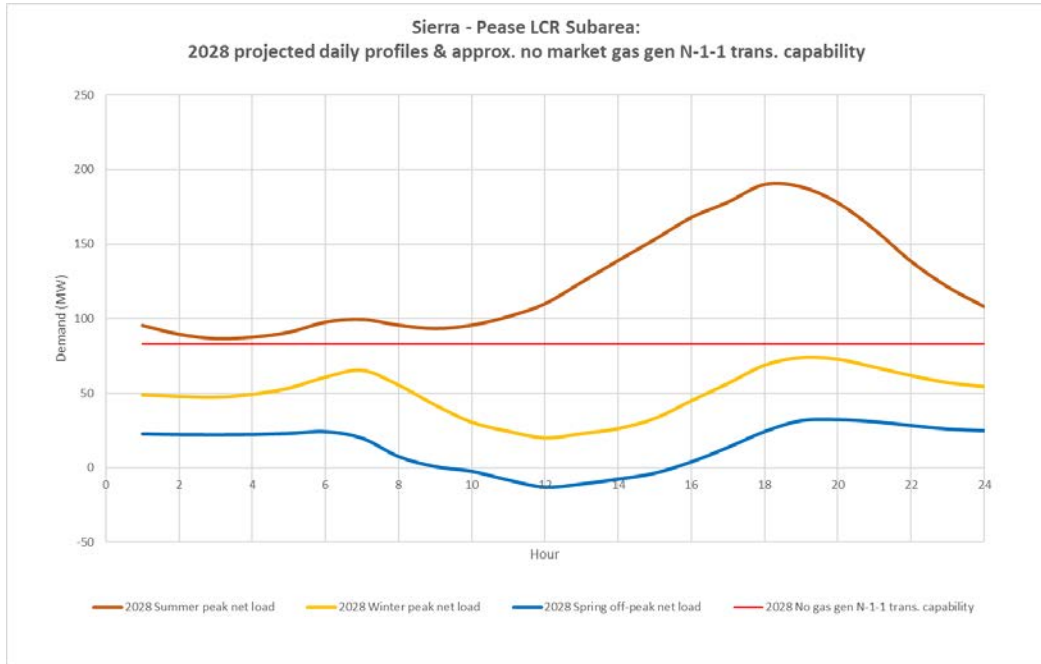
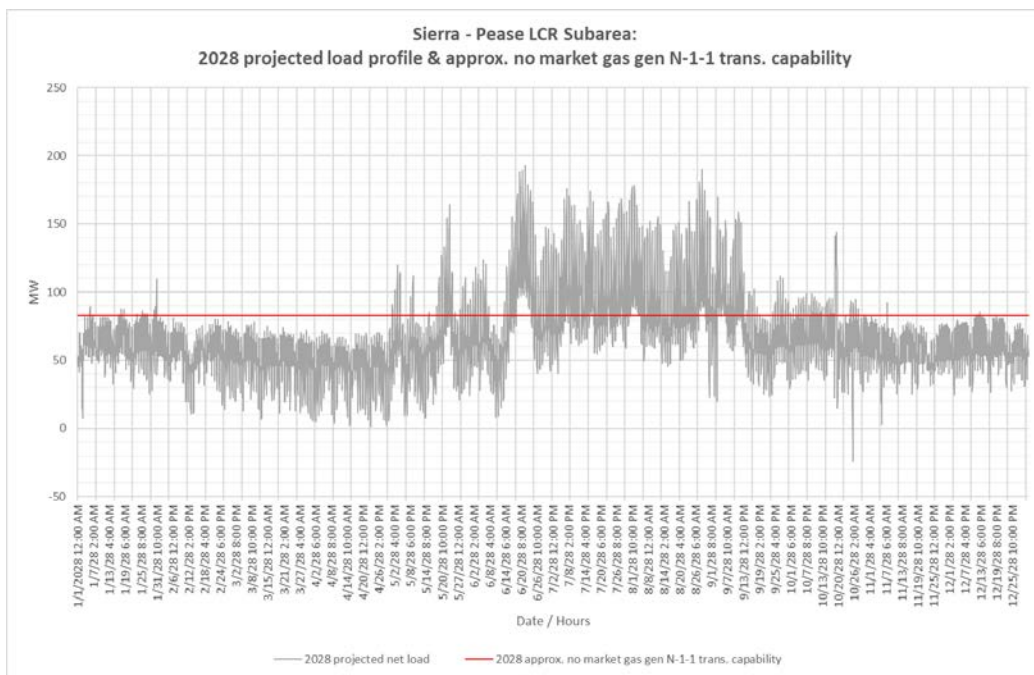

Figure 3.5-13 Pease LCR Sub-area 2028 Forecast Hourly Profiles



3.5.3.4.4 Pease LCR Sub-area Requirement

Table 3.5-9 identifies the Pease 2028 LCR Sub-area requirements. There is no Category B (Single Contingency) LCR requirement and the LCR requirement for Category C (Multiple Contingency) is 92 MW. The second limiting facility and contingency has been provided for information only.

Table 3.5-9 Pease LCR Sub-area Requirements

Year	Limit	Category	Limiting Facility	Contingency	LCR (MW) (Deficiency)
2028	First Limit	B	None	None	0
2028	First Limit	C	Thermal overload of Table Mountain – Pease 60 kV	Palermo – Pease 115 kV and Pease – Rio Oso 115 kV	92
2028	Second Limit	C	Thermal overload of Table Mountain – Pease 60 kV	Pease #1 115/60 kV Tx Pease #2 115/60 kV Tx	54

3.5.3.4.5 Effectiveness factors:

All units within the Pease Sub-area have the same effectiveness factor.

For most helpful procurement information please read procedure 2210Z Effectiveness Factors under 7110 (T-138Z) posted at: <http://www.caiso.com/Documents/2210Z.pdf>

3.5.3.4.6 Alternatives to Reduce or Eliminate Gas Generation

As a part of the 2018-2019 transmission planning process the ISO undertook an assessment in approximately half of the LCR areas and LCR Sub-areas to determine potential transmission alternatives to reduce or eliminate the need for gas-fired generation to meet the LCR requirement. Alternatives in the Pease Sub-area were assessed. The following alternatives were considered.

- Install a Direct Transfer Trip (DTT) to trip the load at Harter upon the loss of 115 kV Lines plus 25 Mvar voltage support
- Convert Table Mountain – Pease 60 kV Line to 115 kV lines
- Looping Palermo – Nicolaus 115 kV line into Pease 115 kV Bus
- Loop in Pease – Marysville 60 kV line into E. Marysville 115 kV substation and install a 115/60 kV transformer at E. Marysville substation plus 25 Mvar voltage support.

Table 3.5-10 provides the LCR requirement for the alternatives identified above. For the alternatives that reduced the LCR requirement but did not eliminate the requirement, the limiting facility and contingency have been provided.

Table 3.5-10 Alternatives to Reduce or Eliminate the Pease Sub-Area Requirement for Gas-fired generation

Year	Limit	Category	Limiting Facility	Contingency	LCR (MW) (Deficiency)
Install a DTT to trip the load at Harter upon the loss of 115 kV Lines plus 25 Mvar voltage support.					
2028	First limit	C	Thermal overload of Table Mountain – Pease 60 kV	Palermo – Pease 115 kV and Pease – Rio Oso 115 kV	50
Convert Table Mountain – Pease 60 kV Line to 115 kV lines					
2028	First limit	C	Thermal overload of Table Mountain – Pease 115 kV	Palermo – Pease 115 kV and Pease – Rio Oso 115 kV	20
Looping Palermo – Nicolaus 115 kV line into Pease 115 kV Bus.					
2028	First limit	C	None	None	0
Loop in Pease – Marysville 60 kV line into E. Marysville 115 kV substation and install a 115/60 kV transformer at E. Marysville substation plus 25 Mvar voltage support.					
2028	First limit	C	None	None	0

Table 3.5-11 provides the cost estimates and the total Pease LCR Sub-area requirement and portion of requirement that would need to be supplied from gas-fired and non gas generation for the alternatives identified above.

Table 3.5-11 Alternative Cost Estimate and LCR Requirement

Alternatives	Submitted By	Estimated Cost (\$M)	Requirement (MW)			
			Total	Market Gas	Other Gas	Non-Gas
Install a DTT to trip the load at Harter upon the loss of 115 kV Lines plus 25 Mvar voltage support.	PG&E	TBD	50	14	36	0
Convert Table Mountain – Pease 60 kV Line to 115 kV lines	PG&E	TBD	20	0	20	0
Looping Palermo – E. Nicolaus 115 kV line into Pease 115 kV Bus.	PG&E	TBD	0	0	0	0
Loop in Pease – Marysville 60 kV line into E. Marysville 115 kV substation and install a 115/60 kV transformer at E. Marysville substation plus 25 Mvar voltage support.	ISO	\$26M-\$32M	0	0	0	0

Two of the alternatives, Install DTT plus reactive support and convert Table Mountain-Pease 60kV line to 115 kV, reduce the Pease Sub-area LCR requirement to 50 MW and 20 MW respectively.

These alternatives also have a higher cost estimate while not eliminating the LCR requirement from gas-fired generation.

Both of the alternatives, looping of the Palermo-East Nicolaus 115 kV line into Pease substation and the Looping in the Pease-Marysville 60 kV line into East Marysville substation would eliminate the LCR requirement for gas-fired generation in the Pease Sub-area. The looping in the Pease-Marysville 60 kv line into East Marysville substation is the preferred alternative for the following reasons.

- Lower estimated cost; and
- Mitigates for the P6 contingency of both Pease 115/60 kV transformers, while the Looping into Palermo-East Nicolaus 115 kV does not and would require an SPS to shed load for this contingency. This is not an LCR criteria requirement; however mitigation is required to meet local reliability standards if the gas-fired generation is not in-service.

The economic assessment of the elimination of the gas-fired generation to address the Pease LCR requirement of the alternative to Loop in Pease – Marysville 60 kV line into E. Marysville 115 kV substation and install a 115/60 kV transformer at E. Marysville substation plus 25 Mvar voltage support is in section 1.9.5 in Chapter 4.

3.5.3.5 *Drum-Rio Oso Sub-area*

Drum-Rio Oso is a Sub-area of the Sierra LCR Area. The 2028 LCT study identified that the Drum-Rio Oso Sub-area will no longer be required due to the Rio Oso 230/115 kV Transformer Upgrade project being in-service.

3.5.3.6 *South of Rio Oso Sub-area*

South of Rio Oso is Sub-area of the Sierra LCR Area.

3.5.3.6.1 *South of Rio Oso LCR Sub-area Diagram*

Figure 3.5-14 Pease LCR Sub-area

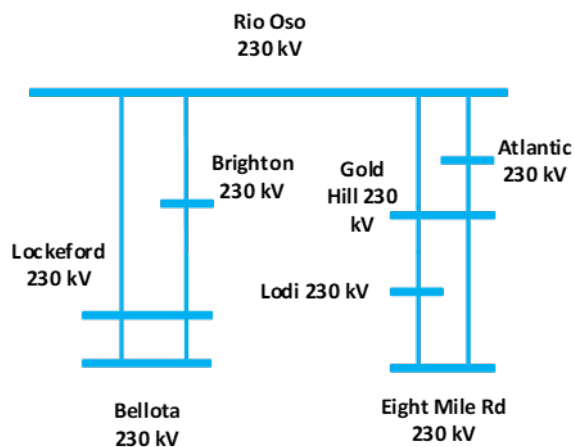

3.5.3.6.2 South of Rio Oso LCR Sub-area Load and Resources

The South of Rio Oso Sub-area does not have a defined load pocket with the limits based upon power flow through the area. Table 3.5-12 provides the forecast resources in the South of Rio Oso LCR Sub-area in 2028. The list of generators within the LCR area are provided in Attachment A.

Table 3.5-12 South of Rio Oso LCR Sub-area 2028 Forecast Load and Resources

Load (MW)	Generation (MW)	
The South of Rio Oso Sub-area does not has a defined load pocket with the limits based upon power flow through the area.	Market Gas	0
	Other Gas	330
	Non-Gas	390
	QF	
	Total Qualifying Capacity	720

3.5.3.6.3 South of Rio Oso LCR Sub-area Hourly Profiles

The South of Rio Oso Sub-area does not has a defined load pocket with the limits based upon power flow through the area. Figure 3.5-15 illustrates the 2017 Category C (Multiple Contingency) post contingency flows on the limiting facility for the summer peak, winter peak and spring off-peak days for the South of Rio Oso Sub-area transmission capability with no market gas. Figure 3.5-16 illustrates the 2017 hourly profile of the Category C (Multiple Contingency) post contingency flows on the limiting facility for South of Rio Oso LCR Sub-area with no market gas. With redispatch of resources in the area after the first contingency the flow would be below the transmission capability in the figures.

Figure 3.5-15 South of Rio Oso LCR Sub-area 2017 Limiting Post Contingency Peak Day Profiles

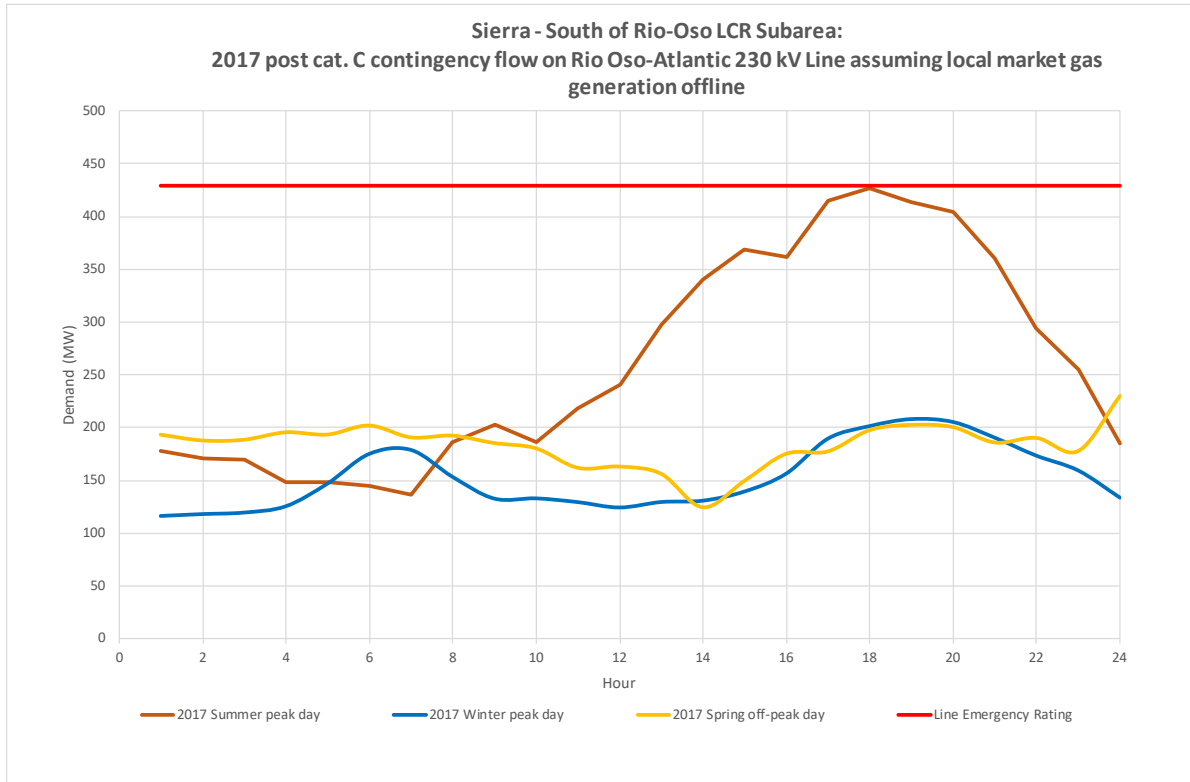
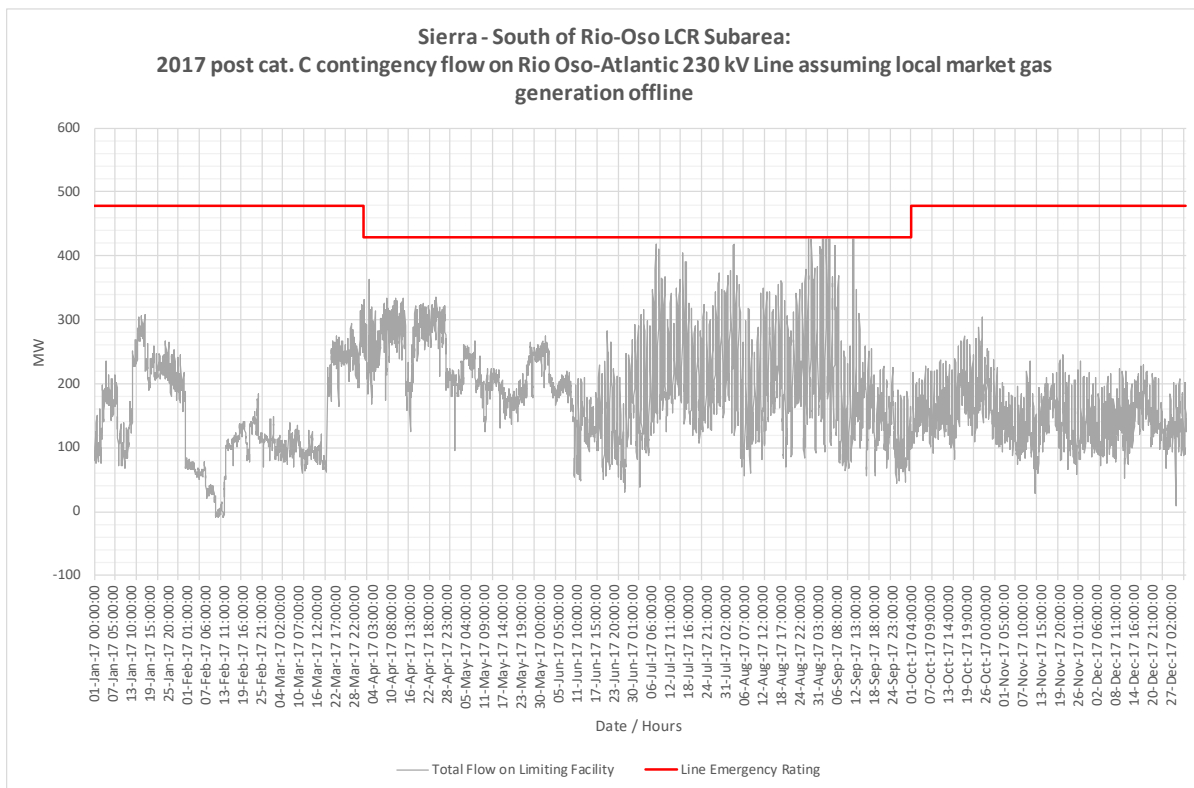

Figure 3.5-16 South of Rio Oso LCR Sub-area 2017 Limiting Post Contingency Hourly Profiles



3.5.3.6.4 South of Rio Osos LCR Sub-area Requirement

Table 3.5-13 identifies the limiting facility and contingency that establishes the South of Rio Oso Sub-area 2028 LCR requirements. The LCR requirement for Category B (Single Contingency) is 348 MW and for Category C (Multiple Contingency) is 390 MW. The second and third limiting facility and contingency has been provided for information only.

Table 3.5-13 South of Rio Oso LCR Sub-area Requirements

Year	Limit	Category	Limiting Facility	Contingency	LCR (MW) (Deficiency)
2028	First limit	B	Rio Oso – Atlantic 230 kV	Rio Oso – Gold Hill 230 kV & Ralston Unit	348 ¹
2028	First limit	C	Rio Oso – Atlantic 230 kV	Rio Oso – Gold Hill 230 kV Rio Oso – Brighton 230 kV	390 ¹
2028	Second limit	C	Rio Oso – Atlantic 230 kV	Rio Oso – Gold Hill 230 kV Rio Oso – Lockeford 230 kV	390 ¹
2028	Third limit	C	Rio Oso – Gold Hill 230 kV	Rio Oso – Atlantic 230 kV Rio Oso – Brighton 230 kV	300

¹ Resources in the area are redispatched after the first contingency

3.5.3.6.5 Effectiveness factors:

Effectic factors for generators in the South of Rio Oso LCR Sub-area are in Attachement B table titled [Rio Oso](#).

For other helpful procurement information please read procedure 2210Z Effectiveness Factors under 7230 (T-165Z) posted at: <http://www.caiso.com/Documents/2210Z.pdf>

3.5.3.6.6 Alternatives to Reduce or Eliminate Gas Generation

As a part of the 2018-2019 transmisson planning process the ISO undertook an assessment in approximately half of the LCR areas and LCR Sub-areas to determine potential transmission alternatives to reduce or eliminate the need for gas-fired generation to meet the LCR requirement. The 2028 LCT study identified for the South of Rio Oso Sub-area that the LCR requirement can be met by the non-gas generation in the area. With this no alternatives were required to be assessed in the 2018-2019 transmission planning process.

3.5.3.7 South of Palermo Sub-area

South of Palermo is a Sub-area of the Sierra LCR Area. The 2028 LCT study identified that there is no additional requirement beyond those established by Pease and South of Rio Oso.

3.5.3.8 South of Table Mountain Sub-area (Sierra Area Overall)

South of Table Mountain is a Sub-area of the Sierra LCR Area.

3.5.3.8.1 South of Table Mountain LCR Sub-area Diagram

Figure 3.5-17 Table Mountain LCR Sub-area

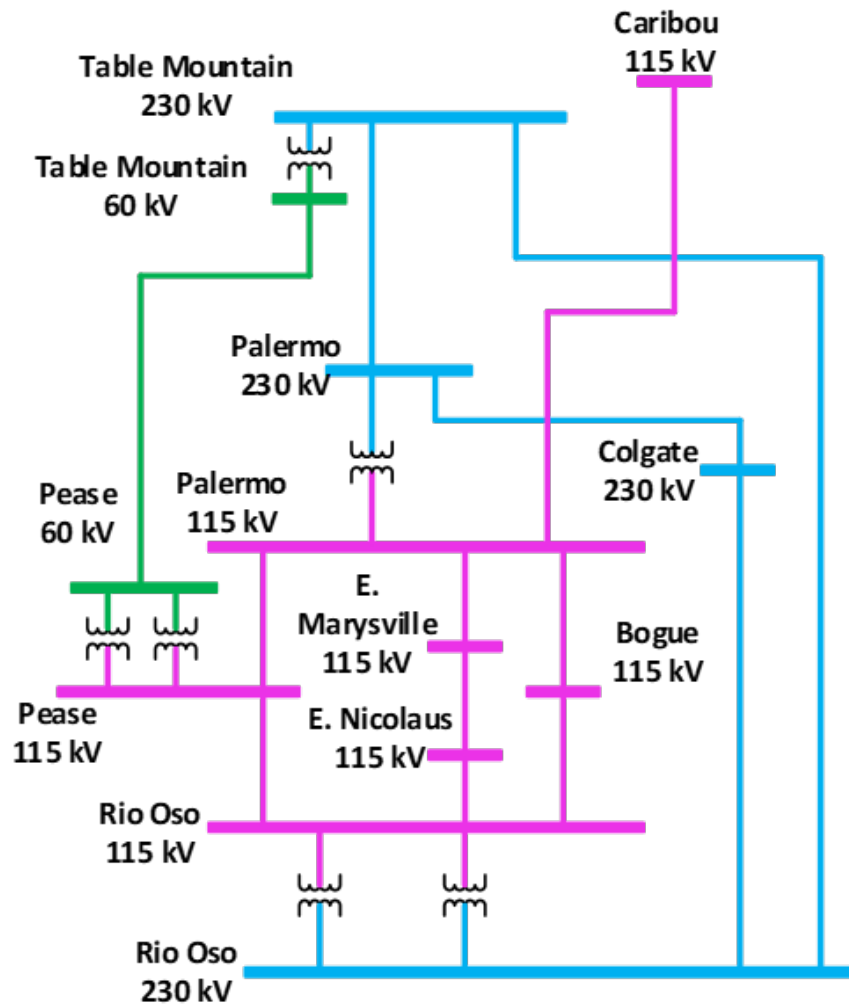

3.5.3.8.2 South of Table Mountain LCR Sub-area Load and Resources

The South of Table Mountain Sub-area does not have a defined load pocket with the limits based upon power flow through the area. Table 3.5-14 provides the forecast resources in the South of Rio Oso LCR Sub-area in 2028. The list of generators within the LCR area are provided in Attachment A.

Table 3.5-14 South of Table Mountain 2028 Forecast Load and Resources

Load (MW)	Generation (MW)	
The South of Rio Oso Sub-area does not has a defined load pocket with the limits based upon power flow through the area.	Market Gas	258
	Other Gas	330
	Non-Gas	1524
	QF	38
	Total Qualifying Capacity	2,150

3.5.3.8.3 South of Table Mountain LCR Sub-area Hourly Profiles

The South of Table Mountain Sub-area does not has a defined load pocket with the limits based upon power flow through the area. Figure 3.5-18 illustrates the 2017 Category C (Multiple Contingency) post contingency flows on the limiting facility for the summer peak, winter peak and spring off-peak days for the South of Table Mountain Sub-area transmission capability with no market gas. Figure 3.5-19 illustrates the 2017 hourly profile of the Category C (Multiple Contingency) post contingency flows on the limiting facility for South of Table Mountain LCR Sub-area with no market gas. With redispatch of resources in the area after the first contingency the flow would be below the transmission capability in the figures.

Figure 3.5-18 South of Table Mountain Sub-area 2017 Limiting Post Contingency Peak Day Profiles

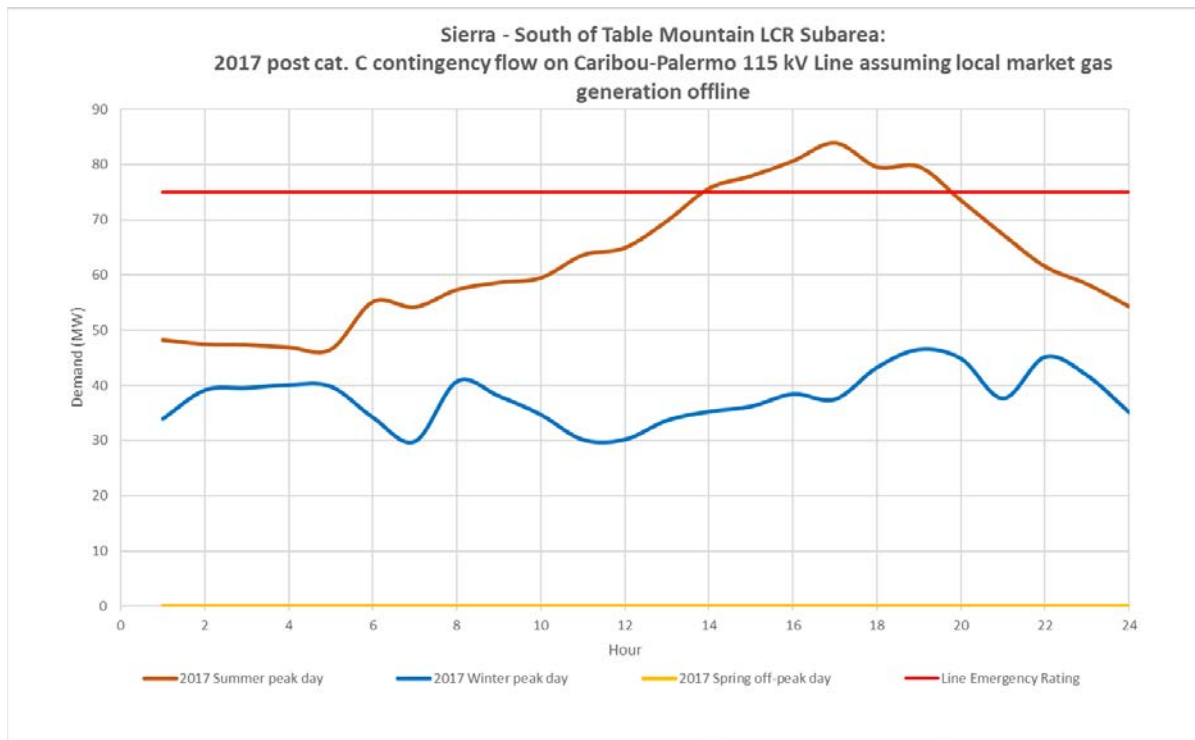

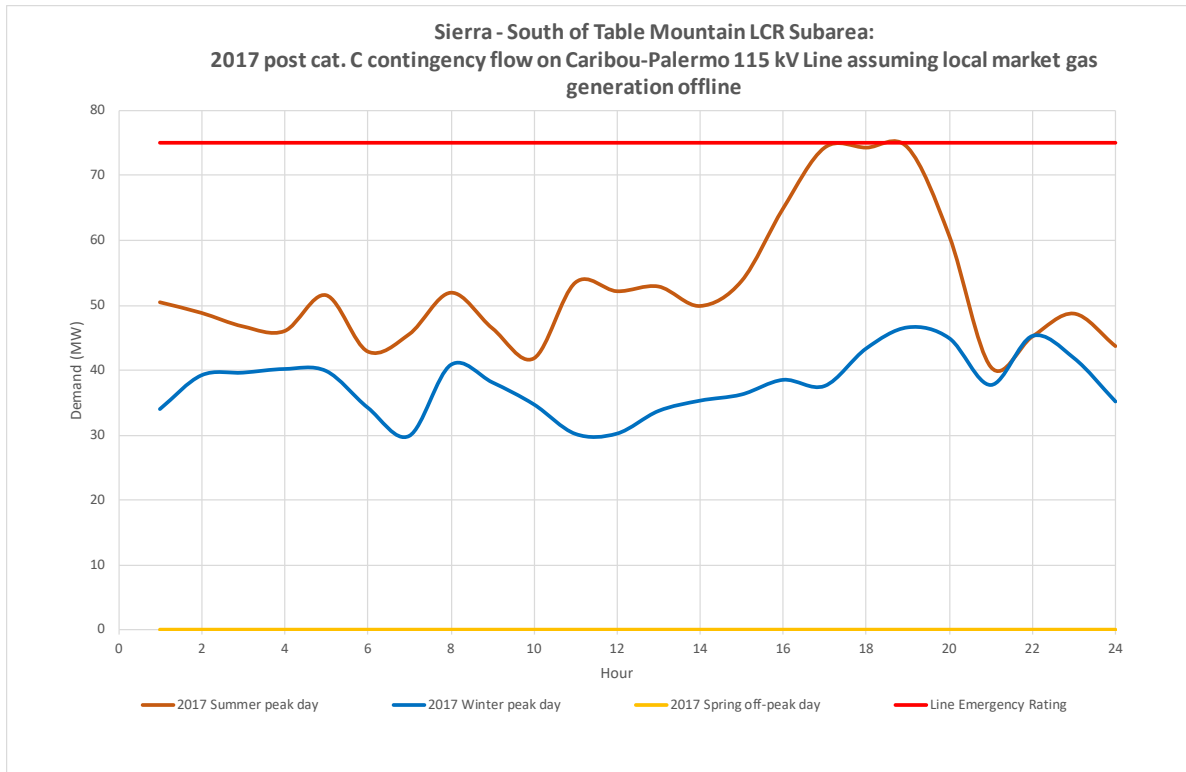
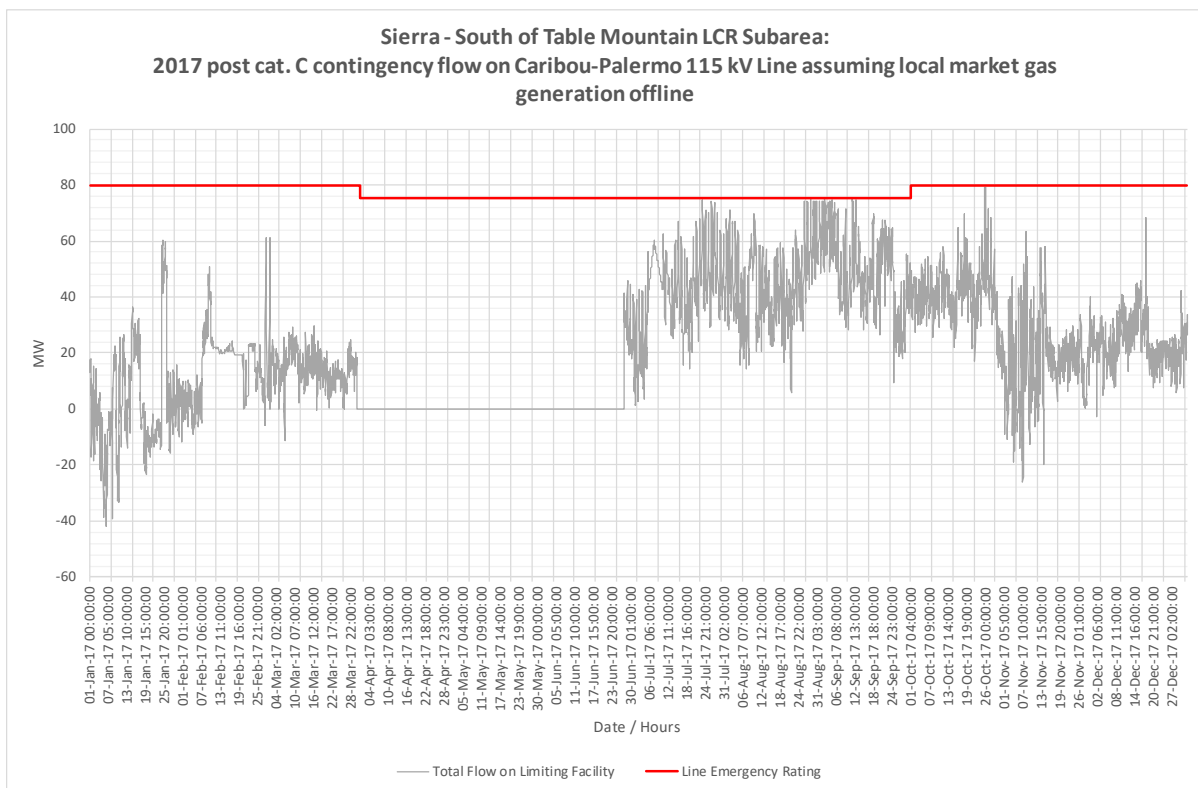

Figure 3.5-19 South of Table Mountain Sub-area 2017 Limiting Post Contingency Hourly Profiles



3.5.3.8.4 South of Table Mountain LCR Sub-area Requirement

Table 3.5-15 identifies the limiting facility and contingency that establishes the South of Table Mountain Sub-area 2028 LCR requirements. The LCR requirement for Category B (Single Contingency) is 1053 MW and for Category C (Multiple Contingency) is 1510 MW. The second limiting facility and contingency has been provided for information only.

Table 3.5-15 South of Table Mountain LCR Sub-area Requirements

Year	Limit	Category	Limiting Facility	Contingency	LCR (MW) (Deficiency)
2028	First limit	B	Caribou – Palermo 115 kV	Table Mountain – Palermo 230 kV	1053
2028	Second limit	B	Table Mountain – Pease 60 kV	Table Mountain – Palermo 230 kV	963
2028	Third limit	B	Table Mountain – Palermo 230 kV	Table Mountain – Rio Oso 230 kV	941
2028	First limit	C	Caribou – Palermo 115 kV	Table Mountain – Palermo 230 kV Table Mountain – Rio Oso 230 kV	1510
2028	Second limit	C	Table Mountain – Pease 60 kV	Table Mountain – Palermo 230 kV Table Mountain – Rio Oso 230 kV	1450

3.5.3.8.5 Effectiveness factors:

Effectic factors for generators in the South of Table Mountain LCR Sub-area are in Attachment B table titled South of Table Mountain.

For other helpful procurement information please read procedure 2210Z Effectiveness Factors under 7230 (T-165Z) posted at: <http://www.caiso.com/Documents/2210Z.pdf>

3.5.3.8.6 Changes compared to last year’s results:

The load forecast went up by 118 MW as compared to 2023. Overall the total LCR for the Sierra area has decreased by 414 MW due to new transmission projects.

3.5.3.8.7 Alternatives to Reduce or Eliminate Gas Generation

As a part of the 2018-2019 transmisson planning process the ISO undertook an assessment in approximately half of the LCR areas and LCR Sub-areas to determine potential transmission alternatives to reduce or eliminate the need for gas-fired generation to meet the LCR requirement. In the 2018-2019 transmission planning process the Sierra LCR Area was selected to assess alternatives to reduce or eliminate the requirement for gas-fired generation to address the LCR requirement. The 2028 LCT study indicates that the requirement can be addressed with nongas-fired generation in the Sierra Area.

3.5.4 Stockton Area

The LCR requirement for the Stockton Area is driven by the sum of the requirements for the Tesla-Bellota and Weber sub-areas. Area Definition:

Tesla-Bellota Sub-Area Definition

The transmission facilities that establish the boundary of the Tesla-Bellota sub-area are:

- 1) Bellota 230/115 kV Transformer #1
- 2) Bellota 230/115 kV Transformer #2
- 3) Tesla-Tracy 115 kV Line
- 4) Tesla-Salado 115 kV Line
- 5) Tesla-Salado-Manteca 115 kV line
- 6) Tesla-Schulte #1 115 kV Line
- 7) Tesla-Schulte #2 115kV line
- 8) Tesla-Vierra 115 kV Line

The substations that delineate the Tesla-Bellota Sub-area are:

- 1) Bellota 230 kV is out Bellota 115 kV is in
- 2) Bellota 230 kV is out Bellota 115 kV is in
- 3) Tesla is out Tracy is in
- 4) Tesla is out Salado is in
- 5) Tesla is out Salado and Manteca are in
- 6) Tesla is out Schulte is in
- 7) Tesla is out Schulte is in
- 8) Tesla is out Thermal Energy is in

Weber Sub-Area Definition

The transmission facilities that establish the boundary of the Weber Sub-area are:

- Weber 230/60 kV Transformer #1
- Weber 230/60 kV Transformer #2

The substations that delineate the Weber Sub-area are:

- Weber 230 kV is out Weber 60 kV is in
- Weber 230 kV is out Weber 60 kV is in

3.5.4.1.1 Stocton LCR Area Diagram

The Stocton LCR Area is comprised of the individual noncontiguous Sub-areas with diagrams provided for each of the Sub-areas below.

3.5.4.1.2 Stocton LCR Area Load and Resources

Table 3.5-16 provides the forecast load and resources in the Stocton LCR Area in 2028. The list of generators within the LCR area are provided in Attachment A.

Table 3.5-16 Stockton LCR Area 2028 Forecast Load and Resources

Load (MW)		Generation (MW)	
Gross Load	1203	Market Gas	432
AAEE	-71	Other Gas	24
Behind the meter DG	0	Non-Gas	210
Net Load	1132		
Transmission Losses	84	QF	18
Pumps	0	Total Qualifying Capacity	684
Load + Losses + Pumps	1153		

3.5.4.1.3 Stocton LCR Area Hourly Profiles

The Stocton LCR Area is comprised of the individual noncontiguous Sub-areas with profiles provided for each of the Sub-areas below.

3.5.4.1.4 Approved transmission projects modeled

- Weber-Stockton "A" #1 and #2 60 kV Reconductoring
- Ripon 115 kV line
- Vierra 115 kV Looping Project
- Lockeford-Lodi Area 230 kV Development

3.5.4.2 Weber Sub-area

Weber is a Sub-area of the Stockton LCR Area.

3.5.4.2.1 Weber LCR Sub-area Diagram

Figure 3.5-20 Weber LCR Sub-area

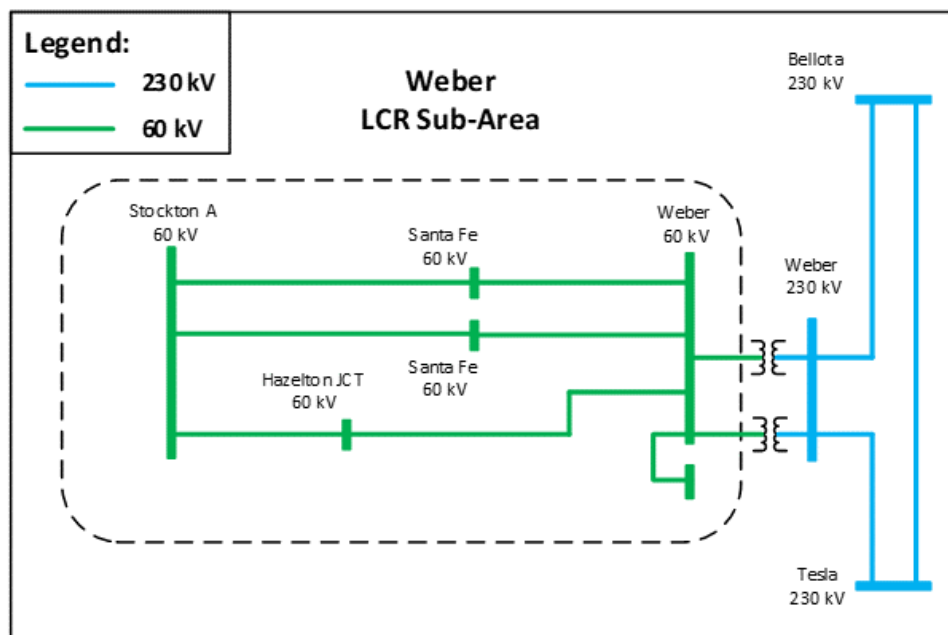

3.5.4.2.2 Weber LCR Sub-area Load and Resources

Table 3.5-17 provides the forecast load and resources in Weber LCR Sub-area in 2028. The list of generators within the LCR Sub-area are provided in Attachment A.

Table 3.5-17 Weber LCR Sub-area 2028 Forecast Load and Resources

Load (MW)		Generation (MW)	
Gross Load	270	Market Gas	47
AAEE	16	Other Gas	0
Behind the meter DG	0	Non-Gas	0
Net Load	254		
Transmission Losses	2	QF	1
Pumps	0	Total Qualifying Capacity	48
Load + Losses + Pumps	256		

3.5.4.2.3 Weber LCR Sub-area Hourly Profiles

Figure 3.5-21 illustrates the forecast 2028 profile for the summer peak, winter peak and spring off-peak days for the Weber LCR Sub-area with the Category C (Multiple Contingency) transmission capability with no market gas. Figure 3.5-22 illustrates the forecast 2028 hourly profile for Weber LCR Sub-area with the Category C (Multiple Contingency) transmission capability with no market gas.

Figure 3.5-21 Weber LCR Sub-area 2028 Peak Day Forecast Profiles

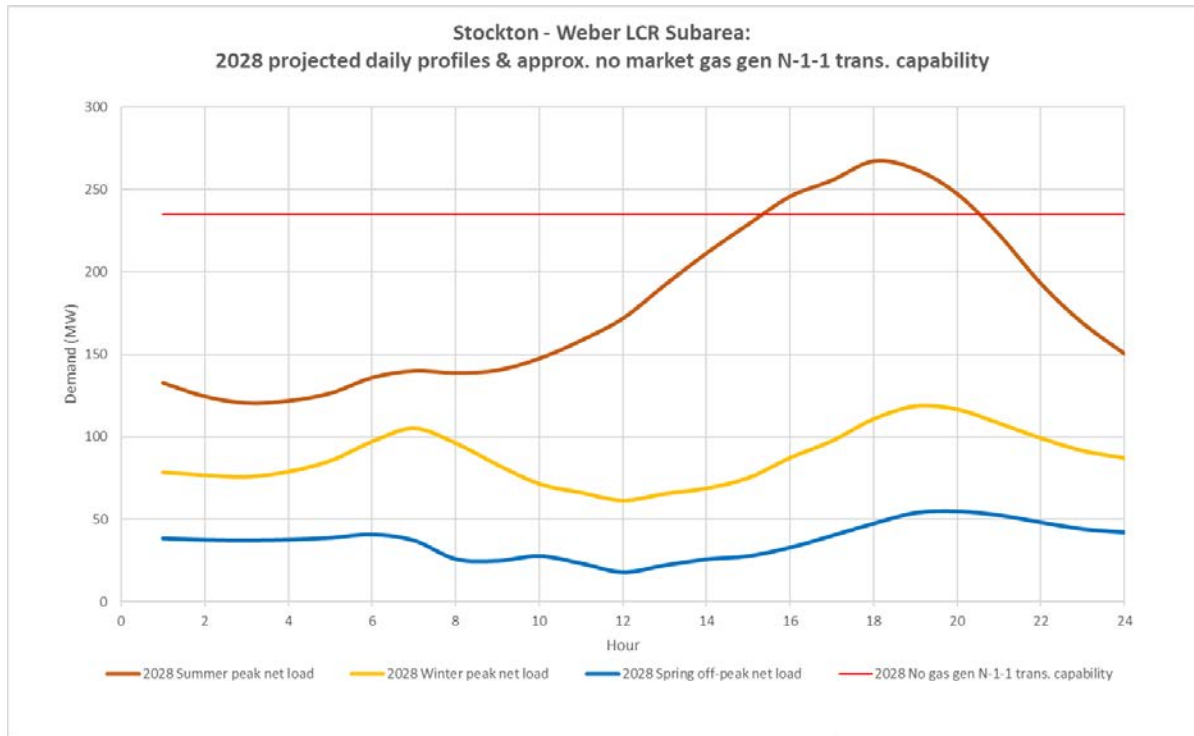
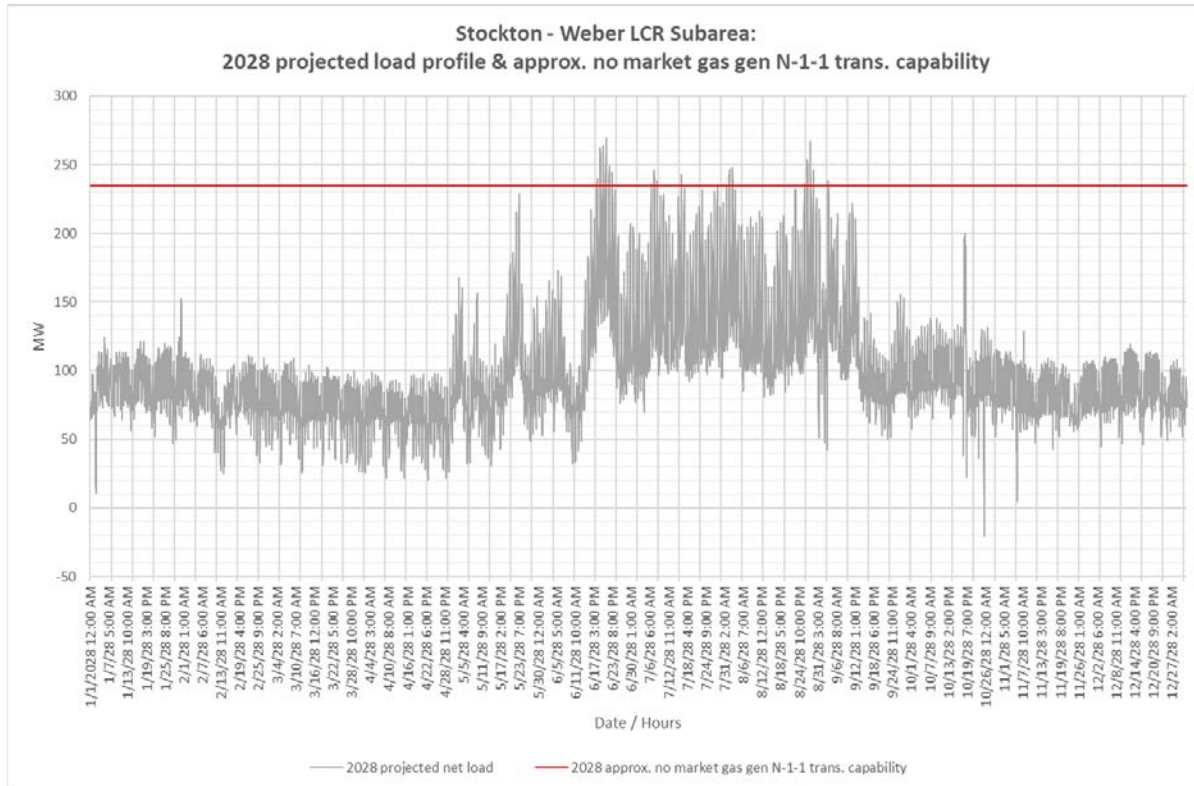

Figure 3.5-22 Weber LCR Sub-area 2028 Forecast Hourly Profiles



3.5.4.2.4 Weber LCR Sub-area Requirement

Table 3.5-18 identifies the Weber 2028 LCR Sub-area requirements. There was no LCR requirement for Category B (Single Contingency) and the LCR Requirement for a Category C (Multiple Contingency) is 30 MW.

Table 3.5-18 Weber LCR Sub-area Requirements

Year	Limit	Category	Limiting Facility	Contingency	LCR (MW) (Deficiency)
2028	First Limit	B	None	None	0
2028	First Limit	C	Stockton A-Weber #3 60 kV	Stockton A-Weber #1 & #2 60 kV	30

3.5.4.2.5 Effectiveness factors:

All units within the Pease Sub-area have the same effectiveness factor.

For most helpful procurement information please read procedure 2210Z Effectiveness Factors under 7110 (T-138Z) posted at: <http://www.caiso.com/Documents/2210Z.pdf>

3.5.4.2.6 Alternatives to Reduce or Eliminate Gas Generation

As a part of the 2018-2019 transmission planning process the ISO undertook an assessment in approximately half of the LCR areas and LCR Sub-areas to determine potential transmission alternatives to reduce or eliminate the need for gas-fired generation to meet the LCR requirement. In the 2018-2019 transmission planning process the Weber LCR Sub-area and Stockton LCR Area were not selected to assess alternatives to reduce or eliminate the requirement for gas-fired generation to address the LCR requirement.

3.5.4.3 Lockeford Sub-area

Lockeford is a Sub-area of the Stockton LCR Area. The 2028 LCT study identified that Lockeford Sub-area will no longer be required due to the Lockeford-Lodi Area 230 kV Development project being in-service.

3.5.4.4 Stanislaus Sub-area

Stanislaus is a Sub-area of the Stockton LCR Area.

3.5.4.4.1 Stanislaus LCR Sub-area Diagram

Figure 3.5-23 Stanislaus LCR Sub-area

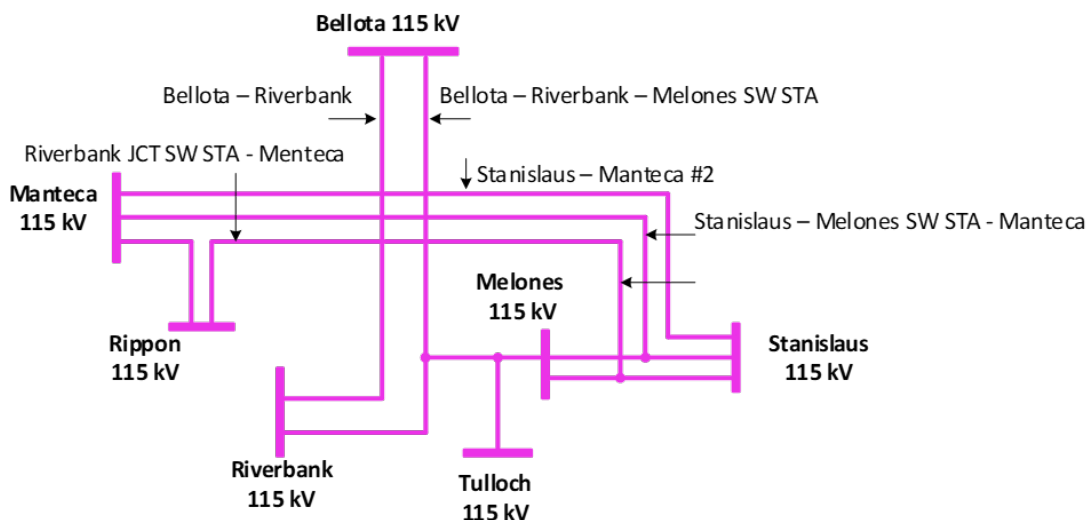

3.5.4.4.2 Stanislaus LCR Sub-area Load and Resources

The Stanislaus Sub-area does not have a defined load pocket with the limits based upon power flow through the area. Table 3.5-19 provides the forecast resources in the Stanislaus LCR Sub-area in 2028. The list of generators within the LCR area are provided in Attachment A.

Table 3.5-19 Stanislaus LCR Sub-area 2028 Forecast Load and Resources

Load (MW)	Generation (MW)	
The Stanislaus Sub-area does not have a defined load pocket with the limits based upon power flow through the area.	Market Gas	0
	Other Gas	0
	Non-Gas	202
	QF	0
	Total Qualifying Capacity	202

3.5.4.4.3 Stanislaus LCR Sub-area Hourly Profiles

The Stanislaus Sub-area does not have a defined load pocket with the limits based upon power flow through the area. Figure 3.5-24 illustrates the 2017 Category C (Multiple Contingency) post contingency flows on the limiting facility for the summer peak, winter peak and spring off-peak days for the Stanislaus Sub-area transmission capability with no market gas. Figure 3.5-25 illustrates the 2017 hourly profile of the Category C (Multiple Contingency) post contingency flows on the limiting facility for Stanislaus LCR Sub-area with no market gas.

Figure 3.5-24 Stanislaus LCR Sub-area 2017 Limiting Post Contingency Peak Day Profiles

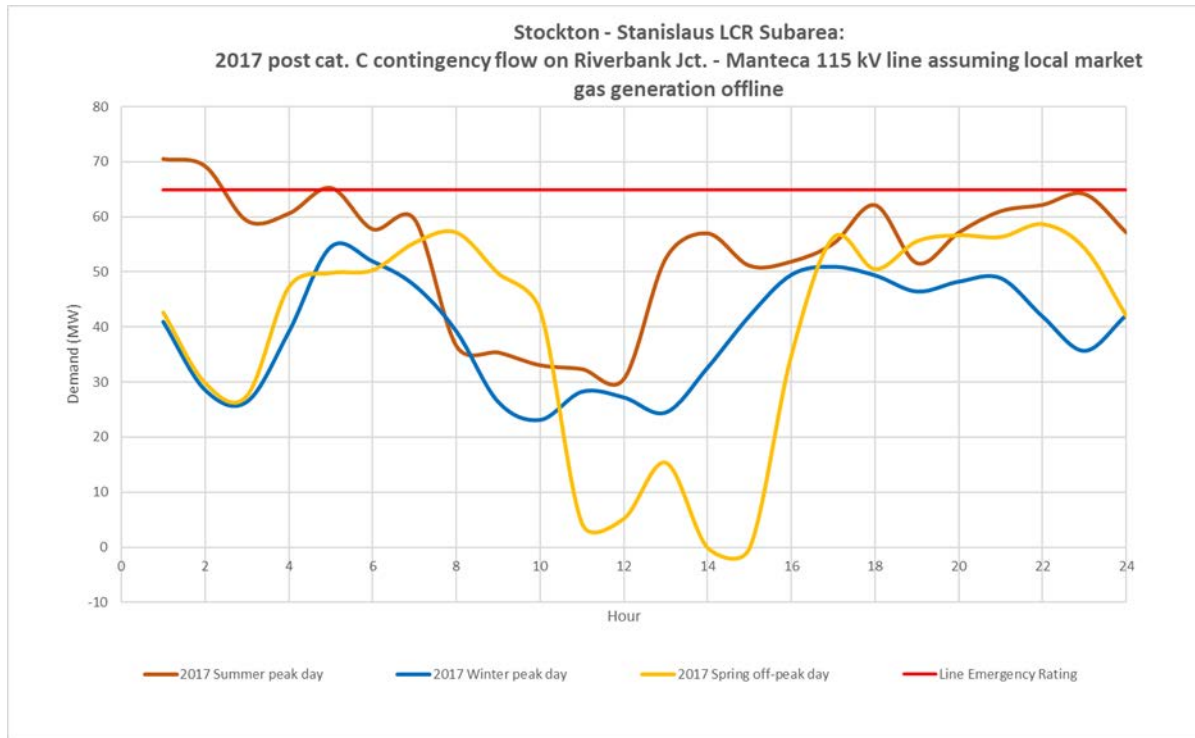
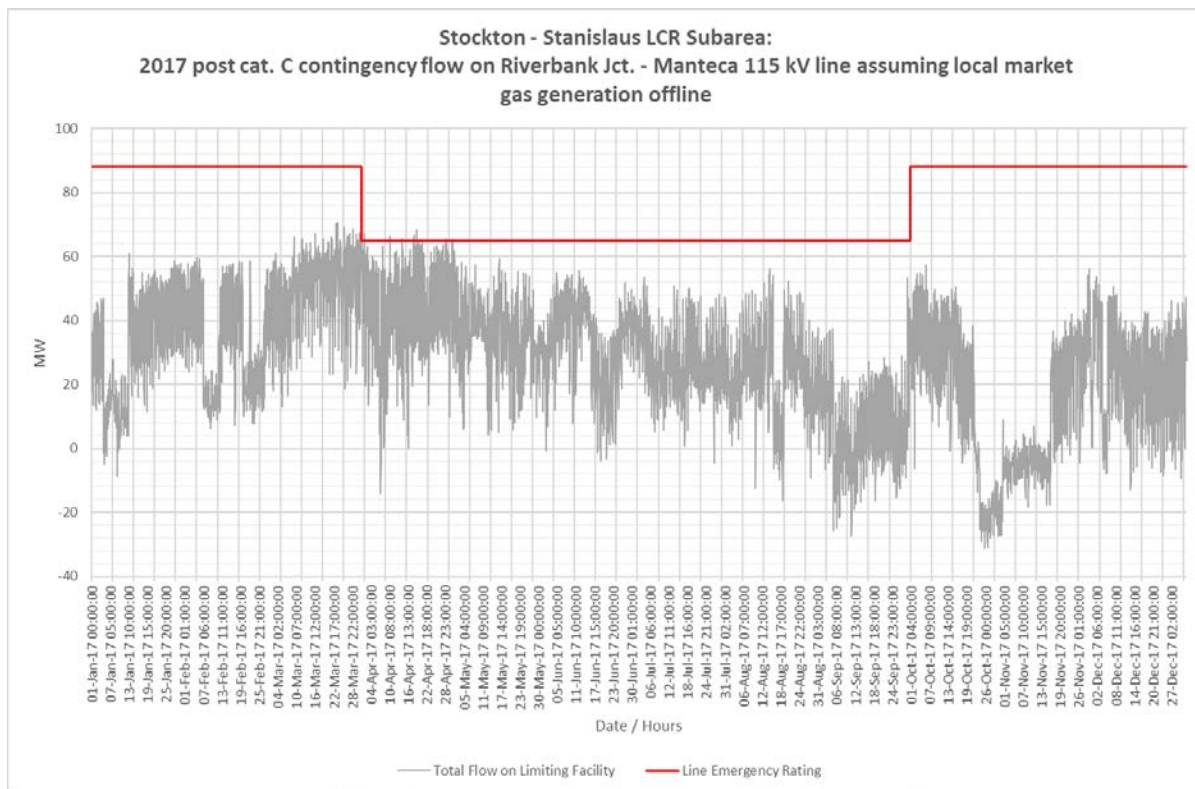

Figure 3.5-25 Stanislaus LCR Sub-area 2017 Limiting Post Contingency Hourly Profiles



3.5.4.4.4 Stanislaus LCR Sub-area Requirement

Table 3.5-20 identifies the limiting facility and contingency that establishes the Stanislaus Sub-area 2028 LCR requirements. The LCR requirement for Category B (Single Contingency) is 174 MW and Category C (Multiple Contingency) requirement is the same.

Table 3.5-20 Stanislaus LCR Sub-area Requirements

Year	Limit	Category	Limiting Facility	Contingency	LCR (MW) (Deficiency)
2028	First limit	B/C	River Bank Jct. – Manteca 115 kV	Bellota-Riverbank-Melones 115 kV and Stanislaus PH	174

3.5.4.4.5 Effectiveness factors:

All units within the Stanislaus Sub-area have the same effectiveness factor.

For most helpful procurement information please read procedure 2210Z Effectiveness Factors under 7110 (T-138Z) posted at: <http://www.caiso.com/Documents/2210Z.pdf>

3.5.4.4.6 Alternatives to Reduce or Eliminate Gas Generation

As a part of the 2018-2019 transmission planning process the ISO undertook an assessment in approximately half of the LCR areas and LCR Sub-areas to determine potential transmission alternatives to reduce or eliminate the need for gas-fired generation to meet the LCR requirement. In the 2018-2019 transmission planning process the Stanislaus Sub-area or Stockton LCR Area was not selected to assess alternatives to reduce or eliminate the requirement for gas-fired generation to address the LCR requirement.

3.5.4.5 **Tesla-Bellota Sub-area**

Tesla-Bellota is a Sub-area of the Stockton LCR Area.

3.5.4.5.1 **Tesla-Bellota LCR Sub-area Diagram**

Figure 3.5-26 Tesla-Bellota LCR Sub-area

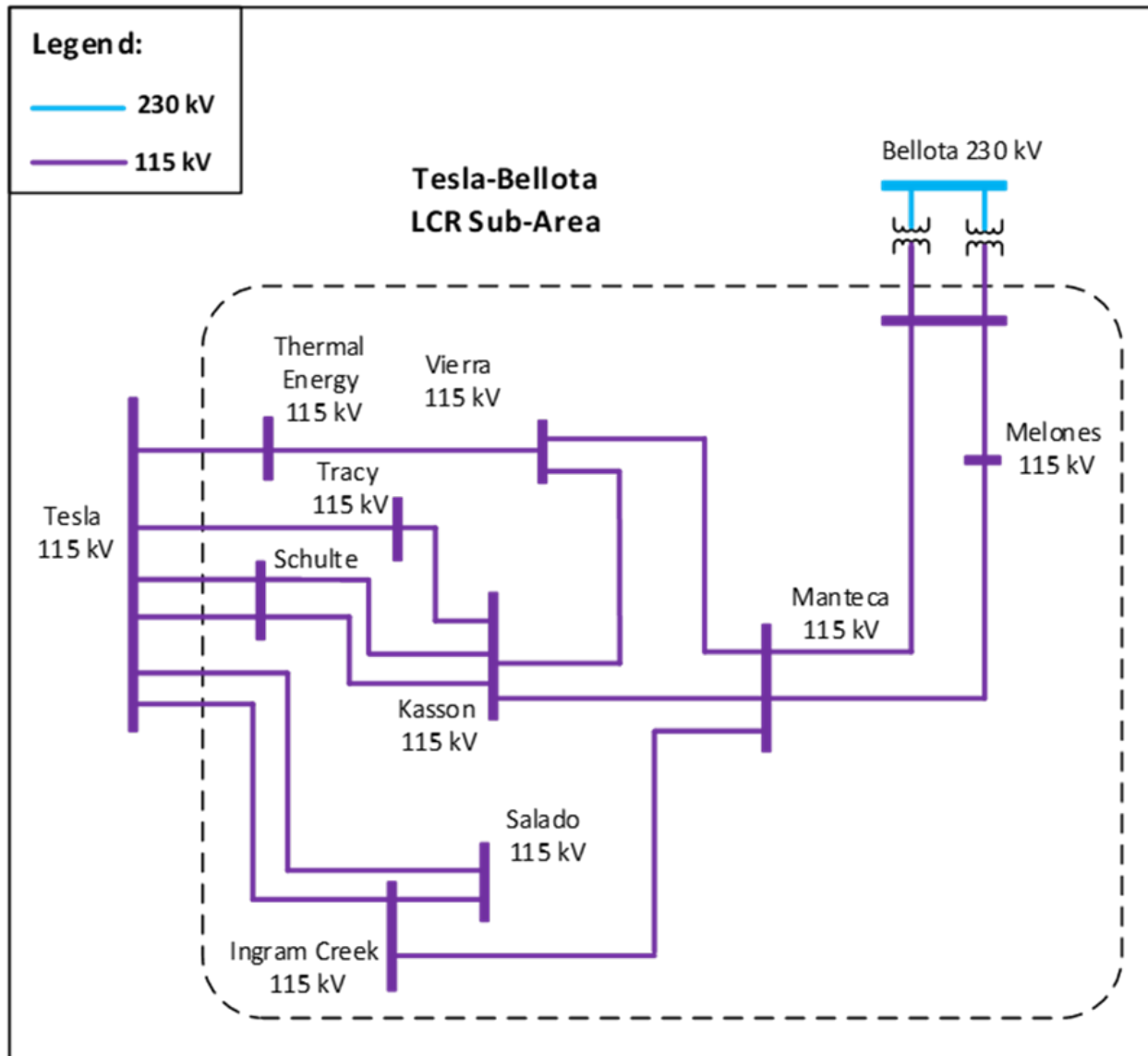

3.5.4.5.2 **Tesla Bellota LCR Sub-area Load and Resources**

Table 3.5-21 provides the forecast load and resources in Tesla-Bellota LCR Sub-area in 2028. The list of generators within the LCR Sub-area are provided in Attachment A.

Table 3.5-21 Tesla Bellota LCR Sub-area 2028 Forecast Load and Resources

Load (MW)		Generation (MW)	
Gross Load	933	Market Gas	376
AAEE	55	Other Gas	0
Behind the meter DG	0	Non-Gas	220
Net Load			
Transmission Losses	19	QF	16
Pumps	0	Total Qualifying Capacity	612
Load + Losses + Pumps	897		

All of the resources needed to meet the Stanislaus sub-area count towards the Tesla-Bellota sub-area LCR need.

3.5.4.5.3 Tesla-Bellota LCR Sub-area Hourly Profiles

The Tesla-Bellota Sub-area does not have a defined load pocket with the limits based upon power flow through the area. Figure 3.5-27 illustrates the 2017 Category C (Multiple Contingency) post contingency flows on the limiting facility for the summer peak, winter peak and spring off-peak days for the Tesla-Bellota Sub-area transmission capability with no market gas. Figure 3.5-28 illustrates the 2017 hourly profile of the Category C (Multiple Contingency) post contingency flows on the limiting facility for Tesla-Bellota LCR Sub-area with no market gas.

Figure 3.5-27 Tesla-Bellota LCR Sub-area 2017 Limiting Post Contingency Peak Day Profiles

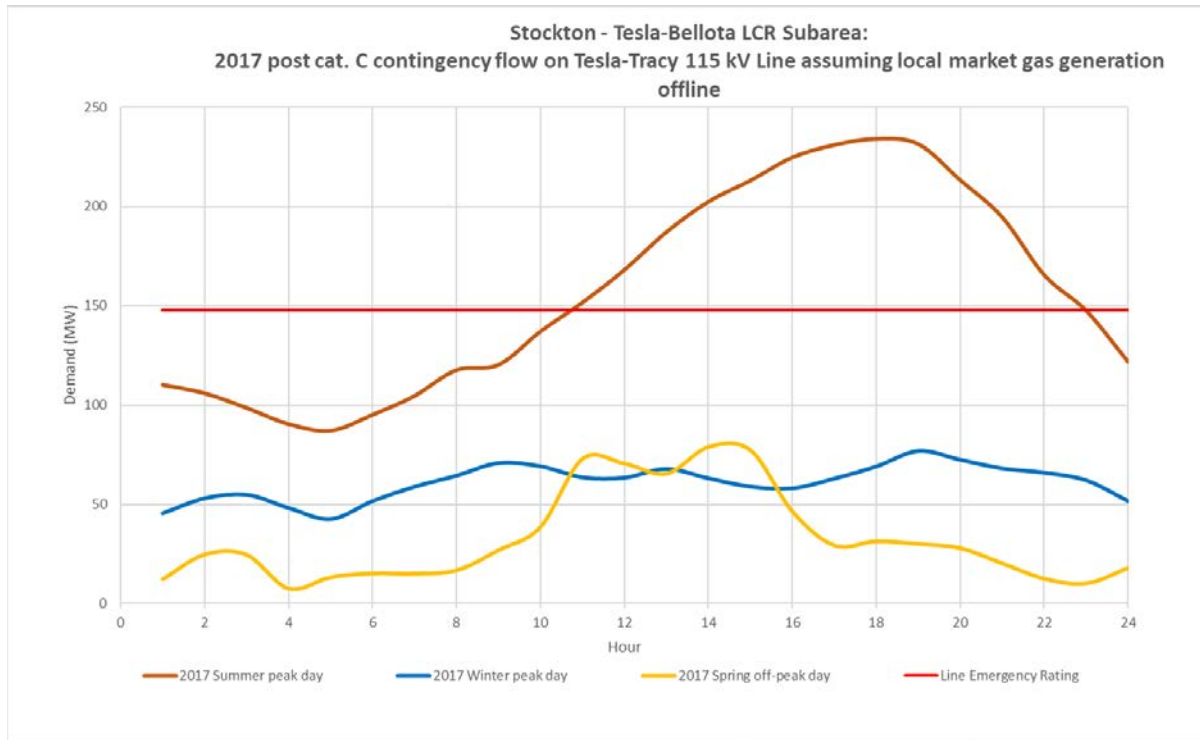
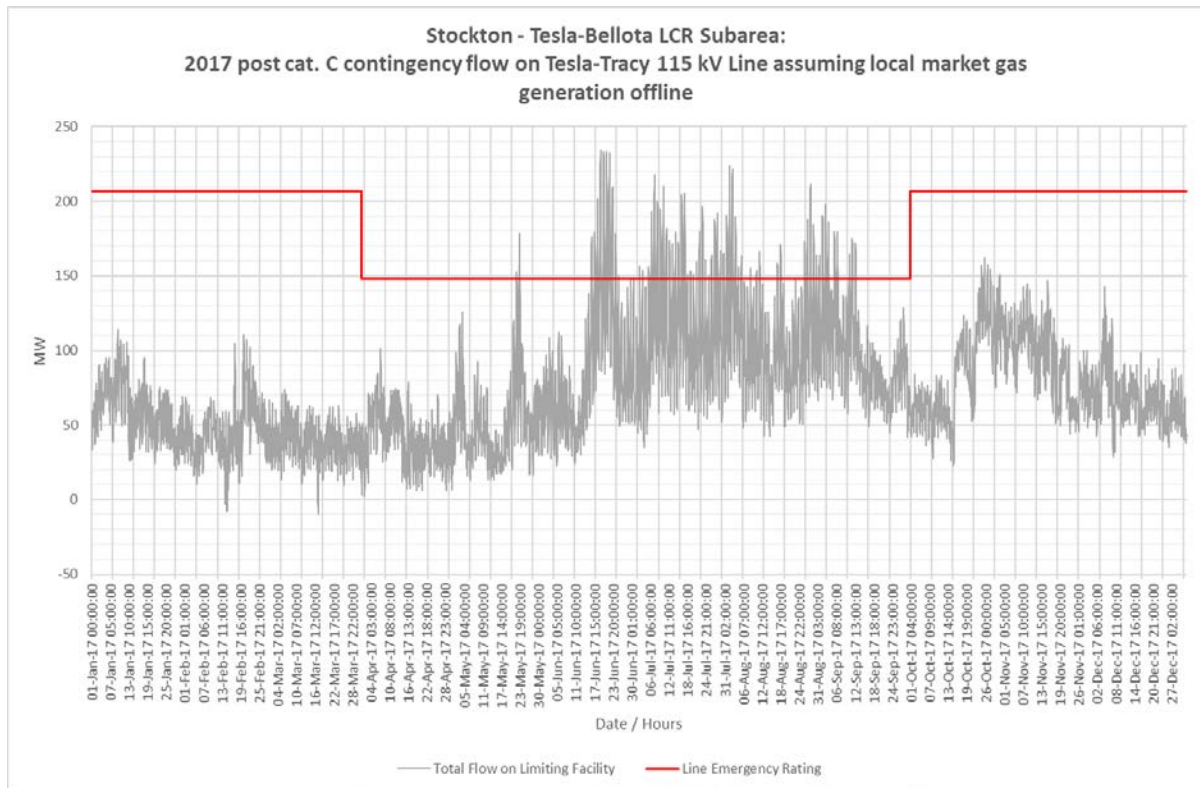

Figure 3.5-28 Tesla-Bellota LCR Sub-area 2017 Limiting Post Contingency Hourly Profiles



3.5.4.5.4 Tesla-Bellota LCR Sub-area (Stockton Overall) Requirement

Table 3.5-22 identifies the limiting facility and contingency that establishes the Tesla-Belota Sub-area 2028 LCR requirements. The LCR requirement for Category B (Single Contingency) is 303 MW and for Category C (Multiple Contingency) is 507 MW with a 213 MW deficiency. The second and third limiting facility and contingency has been provided for information only.

Table 3.5-22 Tesla-Bellota LCR Sub-area Requirements

Year	Limit	Category	Limiting Facility	Contingency	LCR (MW) (Deficiency)
2028	First limit	B	Tesla – Tracy 115 kV	Tesla – Vierra 115 kV and GWF Tracy #3 unit	303
2028	Second limit	B	Tesla – Vierra 115 kV	Tesla – Tracy 115 kV and GWF Tracy #3 unit	291
2028	Third limit	B	Tesla – Tracy 115 kV	Schulte - Lammers115 kV and GWF Tracy #3 unit	239
2028	First limit	C	Tesla – Tracy 115 kV	Schulte - Lammers115 kV and Schulte-Kasson-Manteca 115 kV	507 (213)
2028	Second limit	C	Tesla – Vierra 115 kV	Schulte - Lammers115 kV and Schulte-Kasson-Manteca 115 kV	460 (167)
2028	Third limit	C	Tesla – Schulte #2 115 kV	Tesla – Vierra 115 kV and Tesla – Schulte #1 115 kV	247

3.5.4.5.5 Effectiveness factors:

All units within the Tesla-Bellota Sub-area have the same effectiveness factor.

For most helpful procurement information please read procedure 2210Z Effectiveness Factors under 7110 (T-138Z) posted at: <http://www.caiso.com/Documents/2210Z.pdf>

3.5.4.5.6 Alternatives to Reduce or Eliminate Gas Generation

As a part of the 2018-2019 transmission planning process the ISO undertook an assessment in approximately half of the LCR areas and LCR Sub-areas to determine potential transmission alternatives to reduce or eliminate the need for gas-fired generation to meet the LCR requirement. In the 2018-2019 transmission planning process the Tesla-Bellota LCR Sub-area was not selected to assess alternatives to reduce or eliminate the requirement for gas-fired generation to address the LCR requirement.

3.5.4.6 Stockton Overall

3.5.4.6.1 Stockton LCR Area Overall Requirement

The requirement for this area is driven by the sum of requirements for the Tesla-Bellota and Weber sub-areas. Table 3.5-23 identifies the limiting facility and contingency that establishes the Tesla-Belota Sub-area 2028 LCR requirements. The LCR requirement for Category B (Single Contingency) is 303 MW and for Category C (Multiple Contingency) is 537 MW with a 213 MW deficiency.

Table 3.5-23 Stockotn LCR Sub-area Overall Requirements

Year	Limit	Category	Limiting Facility	Contingency	LCR (MW) (Deficiency)
2028	First Limit	B	None	None	0
2028	First limit	B	Tesla – Tracy 115 kV	Tesla – Vierra 115 kV and GWF Tracy #3 unit	303
2018		B	Stockton Overall		303
2028	First Limit	C	Stockton A-Weber #3	Stockton A-Weber #1 and #2 60 kV	30
2028	First limit	C	Tesla – Tracy 115 kV	Schulte - Lammers 115 kV and Schulte-Kasson-Manteca 115 kV	507 (213)
2018		B	Stockton Overall		537 (213)

3.5.4.6.2 Changes compared to 2023 LCT study

The load forecast went up by 150 MW as compared to 2023. Overall the total LCR for the Stockton area has increased by 98 MW due to increase in load forecast.

3.5.4.6.3 Alternatives to Reduce or Eliminate Gas Generation

As a part of the 2018-2019 transmission planning process the ISO undertook an assessment in approximately half of the LCR areas and LCR Sub-areas to determine potential transmission alternatives to reduce or eliminate the need for gas-fired generation to meet the LCR requirement. In the 2018-2019 transmission planning process the Stockton Area was not selected to assess alternatives to reduce or eliminate the requirement for gas-fired generation to address the LCR requirement.

3.5.5 Greater Bay Area

3.5.5.1 *Area Definition:*

The transmission tie lines into the Greater Bay Area are:

- Lakeville-Sobrante 230 kV
- Ignacio-Sobrante 230 kV
- Parkway-Moraga 230 kV
- Bahia-Moraga 230 kV
- Lambie SW Sta-Vaca Dixon 230 kV
- Peabody-Contra Costa P.P. 230 kV
- Tesla-Kelso 230 kV
- Tesla-Delta Switching Yard 230 kV
- Tesla-Pittsburg #1 230 kV
- Tesla-Pittsburg #2 230 kV
- Tesla-Newark #1 230 kV
- Tesla-Newark #2 230 kV
- Tesla-Ravenswood 230 kV
- Tesla-Metcalf 500 kV
- Moss Landing-Metcalf 500 kV
- Moss Landing-Metcalf #1 230 kV
- Moss Landing-Metcalf #2 230 kV
- Oakdale TID-Newark #1 115 kV
- Oakdale TID-Newark #2 115 kV

The substations that delineate the Greater Bay Area are:

- Lakeville is out Sobrante is in
- Ignacio is out Sobrante is in
- Parkway is out Moraga is in
- Bahia is out Moraga is in
- Lambie SW Sta is in Vaca Dixon is out
- Peabody is out Contra Costa P.P. is in
- Tesla is out Kelso is in

- Tesla is out Delta Switching Yard is in
- Tesla is out Pittsburg is in
- Tesla is out Pittsburg is in
- Tesla is out Newark is in
- Tesla is out Newark is in
- Tesla is out Ravenswood is in
- Tesla is out Metcalf is in
- Moss Landing is out Metcalf is in
- Moss Landing is out Metcalf is in
- Moss Landing is out Metcalf is in
- Oakdale TID is out Newark is in
- Oakdale TID is out Newark is in

3.5.5.1.1 Greater Bay LCR Area Diagram

Figure 3.5-29 Greater Bay LCR Area

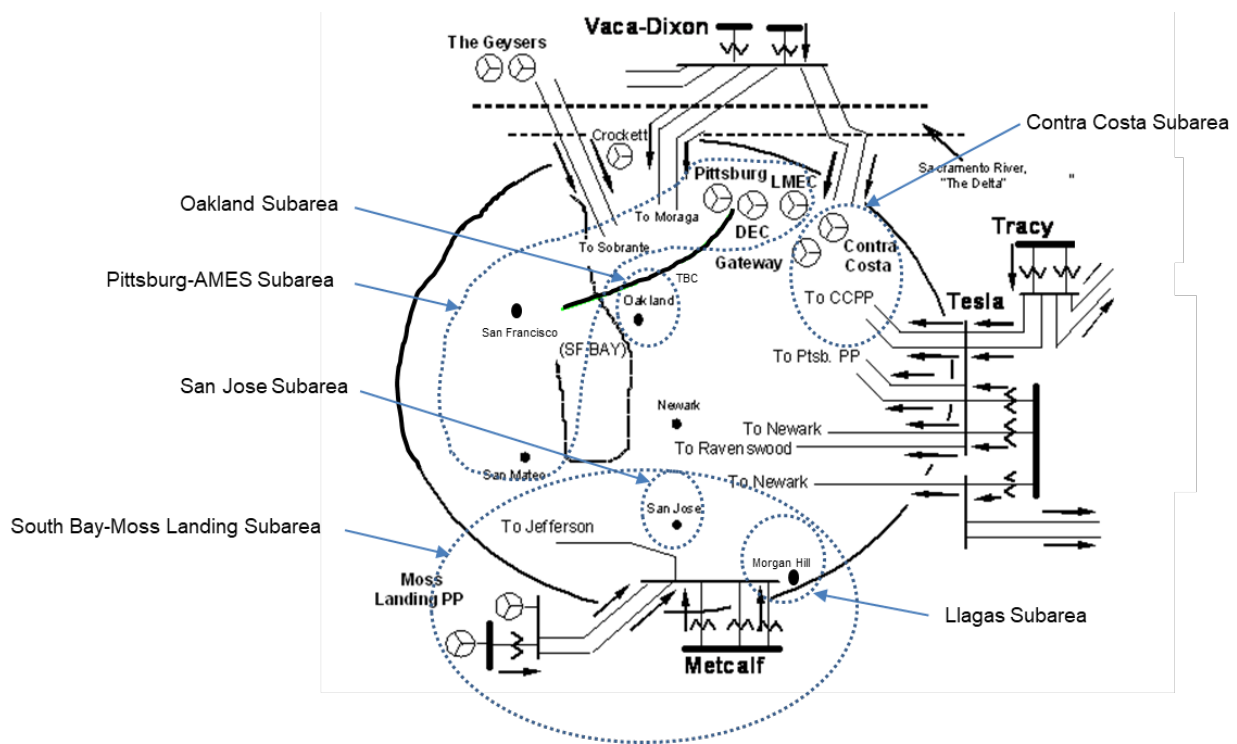

3.5.5.1.2 Greater Bay LCR Area Load and Resources

Table 3.5-24 provides the forecast load and resources in Greater Bay Area LCR area in 2028. The list of generators within the LCR area are provided in Attachment A.

Table 3.5-24 Greater Bay Area LCR Area 2028 Forecast Load and Resources

Load (MW)		Generation (MW)	
Gross Load	11576	Market Gas	5853
AAEE	-653	Other Gas	485
Behind the meter DG	-309	Non-Gas	1273
Net Load	10614		
Transmission Losses	268		
Pumps	264	Total Qualifying Capacity	7611
Load + Losses + Pumps	11146		

3.5.5.1.3 Approved transmission projects modeled

- Oakland Clean Energy Initiative Project (Oakland CTs are assumed retired)
- Morgan Hill Area Reinforcement (revised scope)
- Metcalf-Piercy & Swift and Newark-Dixon Landing 115 kV Upgrade
- East Shore-Oakland J 115 kV Reconductoring Project
- Vaca Dixon-Lakeville 230 kV Corridor Series Compensation
- Metcalf-Evergreen 115 kV Line Reconductoring
- Trimble-San Jose B 115 kV Line Limiting Facility Upgrade
- Trimble-San Jose B 115 kV Series Reactor
- Moss Landing-Panoche 230 kV Path Upgrade
- South of San Mateo Capacity Increase

3.5.5.2 Llagas Sub-area

Llagas is a Sub-area of the Greater Bay LCR Area.

3.5.5.2.1 Llagas LCR Sub-area Diagram

Figure 3.5-30 Llagas LCR Sub-area

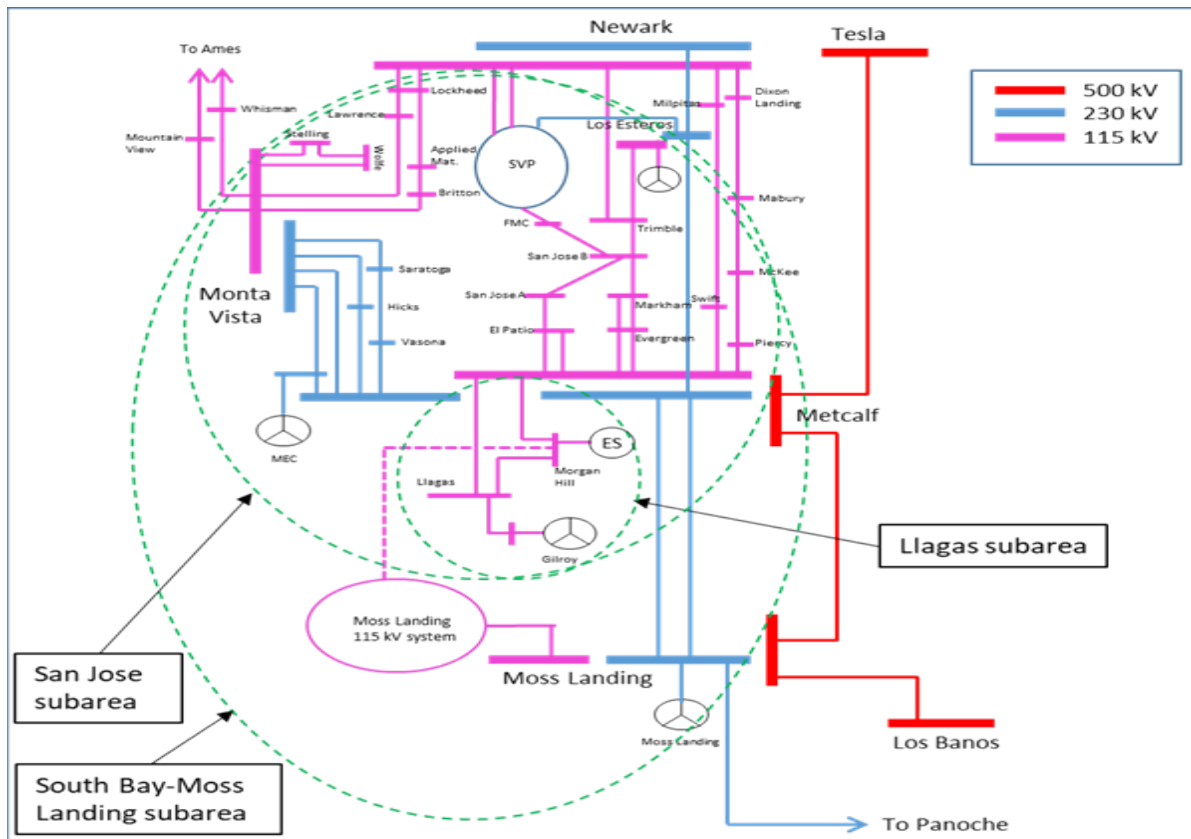

3.5.5.2.2 Llagas LCR Sub-area Load and Resources

Table 3.5-25 provides the forecast load and resources in Llagas LCR Sub-area in 2028. The list of generators within the LCR Sub-area are provided in Attachment A.

Table 3.5-25 Llagas LCR Sub-area 2028 Forecast Load and Resources

Load (MW)		Generation (MW)	
Gross Load	212	Market Gas	247
AAEE	-12	Other Gas	0
Behind the meter DG	-9	Non-Gas	0
Net Load	191		
Transmission Losses	0	Future preferred resource and energy storage (Resolution E-4949)	75
Pumps	0	Total Qualifying Capacity	322
Load + Losses + Pumps	191		

3.5.5.2.3 Llagas LCR Sub-area Hourly Profiles

Figure 3.5-31 illustrates the forecast 2028 profile for the summer peak, winter peak and spring off-peak days for the Llagas LCR Sub-area with the Category C (Multiple Contingency) transmission capability with no market gas. Figure 3.5-32 illustrates the forecast 2028 hourly profile for Llagas LCR Sub-area with the Category C (Multiple Contingency) transmission capability with no market gas.

Figure 3.5-31 Llagas LCR Sub-area 2028 Peak Day Forecast Profiles

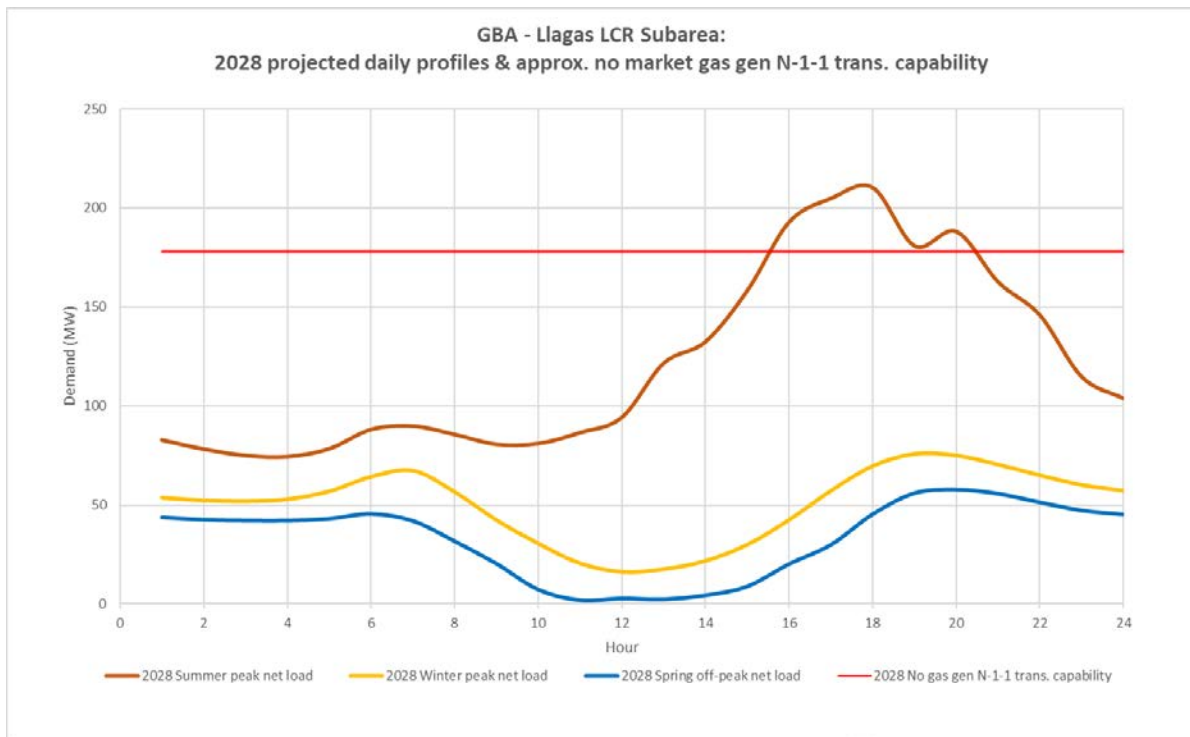
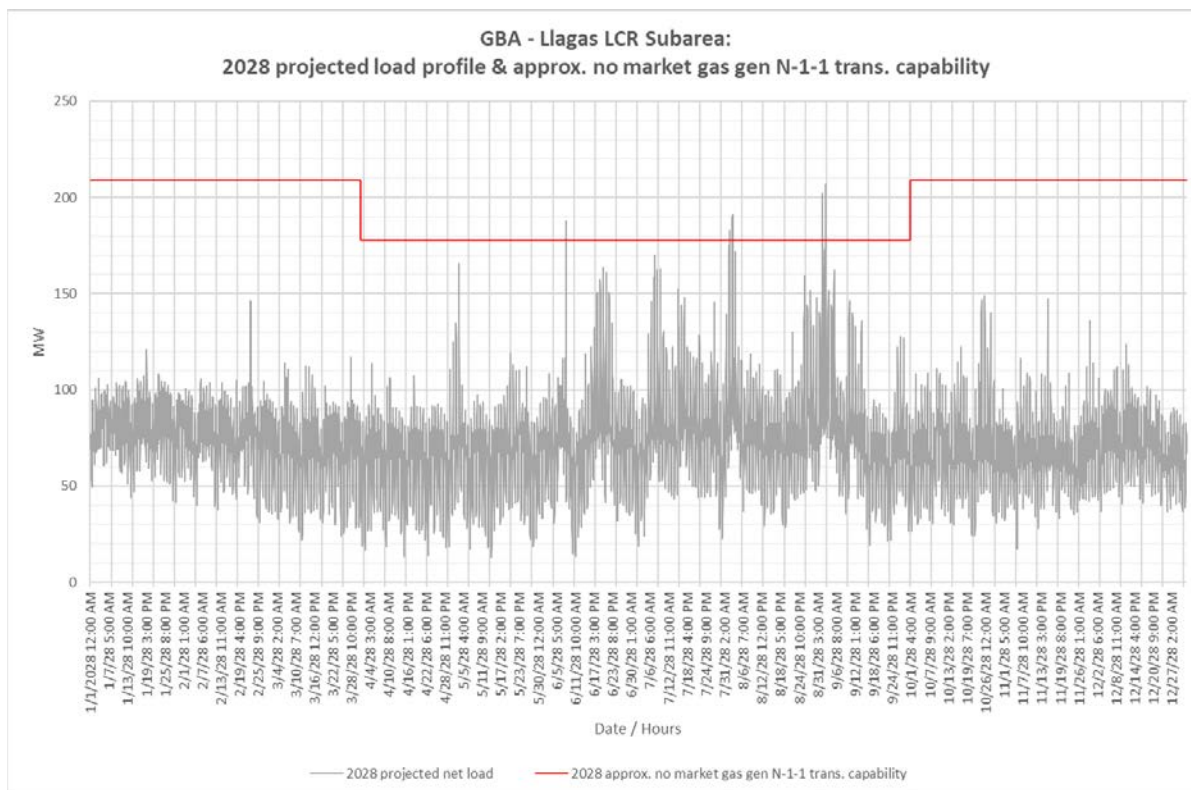

Figure 3.5-32 Llagas LCR Sub-area 2028 Forecast Hourly Profiles



3.5.5.2.4 Llagas LCR Sub-area Requirement

Table 3.5-26 identifies the Llagas 2028 LCR Sub-area requirements. There was no LCR requirement for Category B (Single Contingency) and the LCR Requirement for a Category C (Multiple Contingency) is 33 MW.

Table 3.5-26 Llagas LCR Sub-area Requirements

Year	Limit	Category	Limiting Facility	Contingency	LCR (MW) (Deficiency)
2028	First limit	B	None	None	0
2028	First limit	C	Morgan Hill-Llagas 115 kV	Metcalf-Morgan Hill 115 kV Morgan Hill-Green Valley 115 kV	33

3.5.5.2.5 Effectiveness factors:

All units within the Llagas Sub-area have the same effectiveness factor.

For most helpful procurement information please read procedure 2210Z Effectiveness Factors under 7110 (T-138Z) posted at: <http://www.aiso.com/Documents/2210Z.pdf>

3.5.5.2.6 Alternatives to Reduce or Eliminate Gas Generation

As a part of the 2018-2019 transmission planning process the ISO undertook an assessment in approximately half of the LCR areas and LCR Sub-areas to determine potential transmission alternatives to reduce or eliminate the need for gas-fired generation to meet the LCR requirement. In the 2018-2019 transmission planning process the Llagas LCR Sub-area was selected to assess alternatives to reduce or eliminate the requirement for gas-fired generation to address the LCR requirement.

The 75 MW of storage resources that were approved in Resolution E-4949 with the approved transmission projects address the LCR requirements in Llagas LCR Sub-area with out requiring gas-fired generation.

3.5.5.3 San Jose Sub-area

San Jose is a Sub-area of the Greater Bay LCR Area.

3.5.5.3.1 San Jose LCR Sub-area Diagram

The San Jose LCR Sub-area is identified in Figure 3.2-30.

3.5.5.3.2 San Jose LCR Sub-area Load and Resources

Table 3.5-27 provides the forecast load and resources in San Jose LCR Sub-area in 2028. The list of generators within the LCR Sub-area are provided in Attachment A.

Table 3.5-27 San Jose LCR Sub-area 2028 Forecast Load and Resources

Load (MW)		Generation (MW)	
Gross Load	3101	Market Gas	1139
AAEE	-199	Other Gas	202
Behind the meter DG	-60	Non-Gas	0
Net Load	2842		
Transmission Losses	83	Future preferred resource and energy storage (Resolution E-4949)	75
Pumps	0	Total Qualifying Capacity	1416
Load + Losses + Pumps	2925		

3.5.5.3.3 San Jose LCR Sub-area Hourly Profiles

Figure 3.5-33 illustrates the forecast 2028 profile for the summer peak, winter peak and spring off-peak days for the San Jose LCR Sub-area with the Category C (Multiple Contingency) transmission capability with no market gas. Figure 3.5-34 illustrates the forecast 2028 hourly profile for San Jose LCR Sub-area with the Category C (Multiple Contingency) transmission capability with no market gas.

Figure 3.5-33 San Jose LCR Sub-area 2028 Peak Day Forecast Profiles

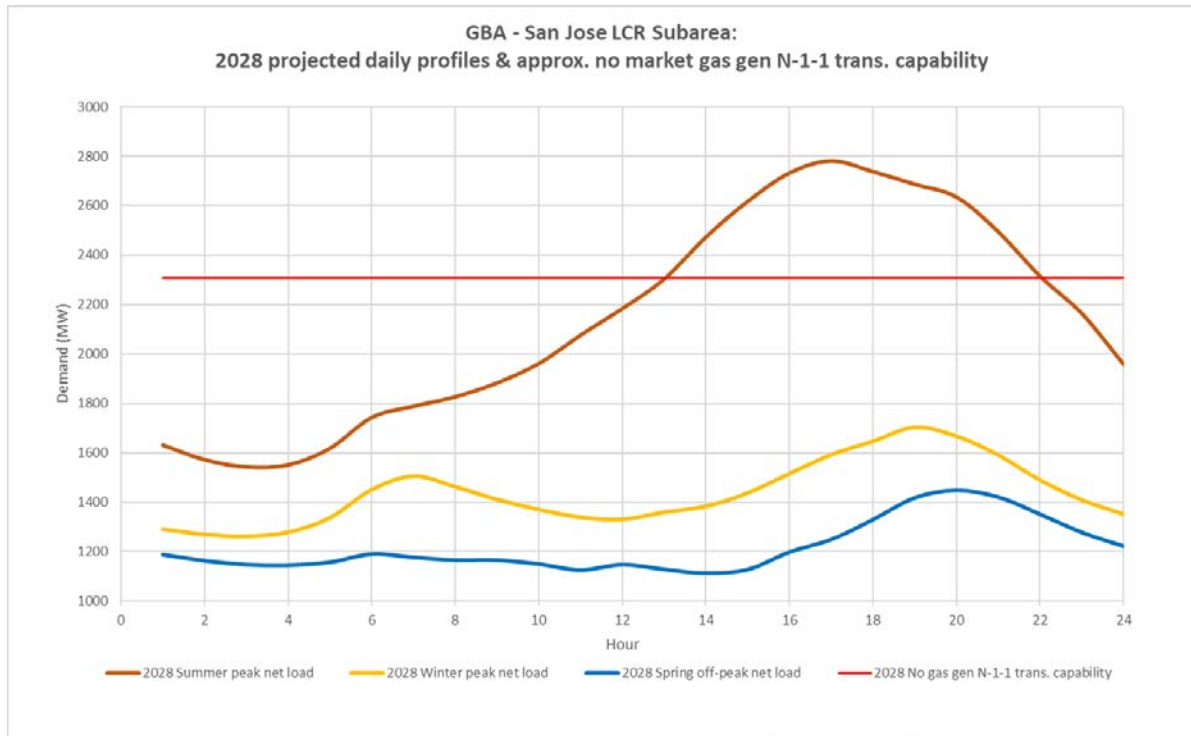
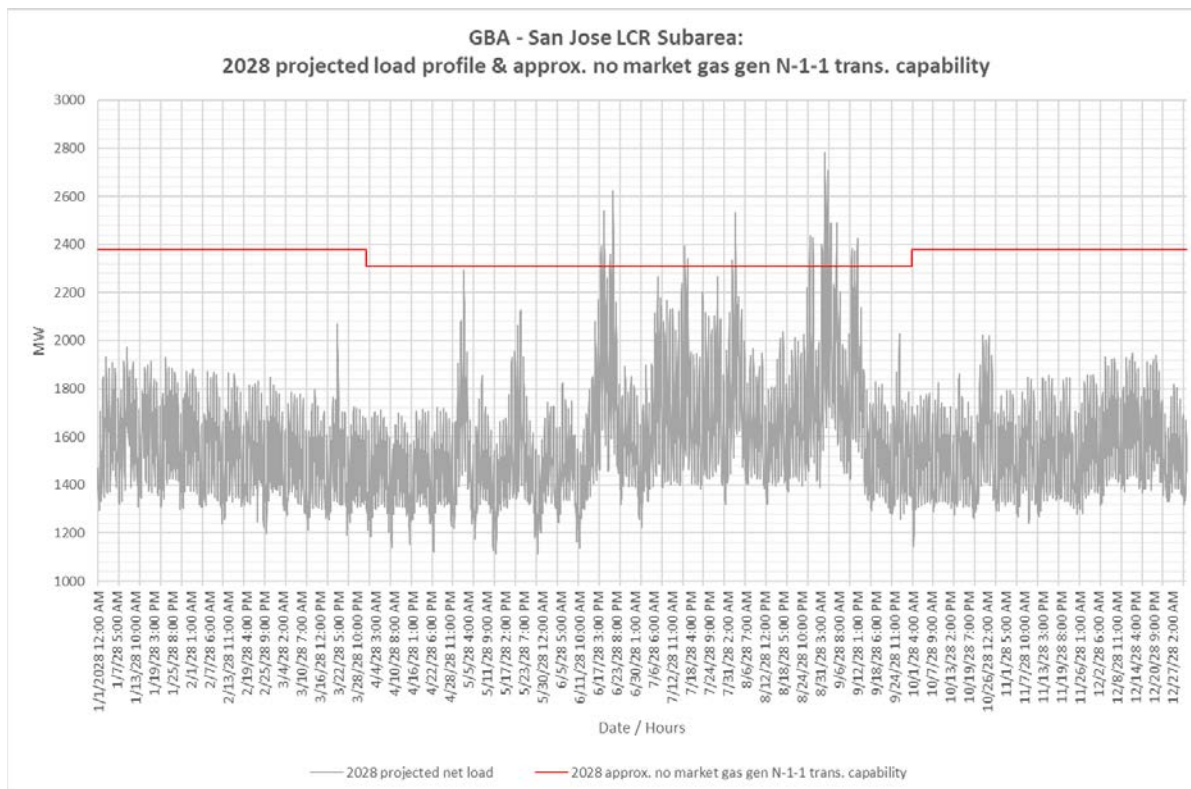

Figure 3.5-34 San Jose LCR Sub-area 2028 Forecast Hourly Profiles



3.5.5.3.4 San Jose LCR Sub-area Requirement

Table 3.5-28 identifies the limiting facility and contingency that establishes the San Jose Sub-area 2028 LCR requirements. The LCR requirement for Category B (Single Contingency) is 868 MW and for Category C (Multiple Contingency) is 1543 MW with a 204 MW deficiency. The second and third limiting facility and contingency has been provided for information only.

Table 3.5-28 San Jose LCR Sub-area Requirements

Year	Limit	Category	Limiting Facility	Contingency	LCR (MW) (Deficiency)
2028	First limit	B	El Patio-San Jose A 115 kV	Newark-Los Esteros 230 kV line & DVR unit	868
2028	First limit	C	Newark-NRS #1 115 kV	Newark-Los Esteros 230 kV & Metcalf-Los Esteros 230 kV	1543 (204)
2028	Second limit	C	Newark-NRS #2 115 kV	Newark-Los Esteros 230 kV & Metcalf-Los Esteros 230 kV	1435 (156)
2028	Third limit	C	Newark-Kifer 115 kV	Newark-Los Esteros & Metcalf-Los Esteros 230 kV lines	1208
Multiple subsequent constraints with limiting facilities within the San Jose 115 kV system					

Within the San Jose LCR Sub-area there are significant subsequent constraints with limiting facilities with 34 separate P6 contingencies that result in overloading 11 separate facilities.

3.5.5.3.5 Effectiveness factors:

Effectiveness factors for generators in the San Jose LCR Sub-area are in Attachment B table titled San Jose.

For other helpful procurement information please read procedure 2210Z Effectiveness Factors under 7230 (T-165Z) posted at: <http://www.aiso.com/Documents/2210Z.pdf>

3.5.5.3.6 Alternatives to Reduce or Eliminate Gas Generation

As a part of the 2018-2019 transmission planning process the ISO undertook an assessment in approximately half of the LCR areas and LCR Sub-areas to determine potential transmission alternatives to reduce or eliminate the need for gas-fired generation to meet the LCR requirement. Alternatives in the San Jose Sub-area were assessed. The following alternatives were considered.

- New Sunol 500 kV substation
- Reconductor nine 115 kV lines (~85 miles)
- With ~600 MW of preferred resource / storage distributed throughout San Jose Sub-area
- With 4-terminal DC (2000-350-300-1350) & 500 MVAR Reactive Support
- With 4-terminal DC (2000-350-300-1350), 500 MVAR Reactive Support & Eight SVP connecting Facilities Upgrade

Table 3.5-29 provides the LCR requirement for the alternatives identified above. For the alternatives that reduced the LCR requirement but did not eliminate the requirement, the limiting facility and contingency have been provided.

Table 3.5-29 Alternatives to Reduce or Eliminate the San Jose Sub-Area Requirement for Gas-fired generation

Year	Limit	Category	Limiting Facility	Contingency	LCR (MW) (Deficiency)
New Sunol 500 kV substation					
New Sunol 500 kV substation exacerbates the San Jose Sub-area constraint increasing the LCR need compared to the baseline.					
Reconductor nine 115 kV lines (~85 miles)					
2028	First Limit	C	Newark-Los Esteros 230 kV line	Newark 230/115 kV bank #9 and Los Esteros-Metcalf 230 kV line	196
With ~600 MW of preferred resource / storage distributed throughout San Jose Sub-area					
2028	First Limit	C	Newark-NRS #1 115 kV line	Newark-Los Esteros & Metcalf-Los Esteros 230 kV lines	100-700
With 4-terminal DC (2000-350-300-1350) & 500 MVAR Reactive Support					
2028	First Limit	C	Kifer-FMC 115 kV line	Los Esteros-Nortech and Newark-Zanker-Kifer 115 kV lines	209
With 4-terminal DC (2000-350-300-1350), 500 MVAR Reactive Support & Eight SVP connecting Facilities Upgrade					
2028	First Limit	C	None	None	None

Table 3.5-30 provides the cost estimates and the total San Jose LCR Sub-area requirement and portion of requirement that would need to be supplied from gas-fired and non gas generation for the alternatives identified above

Table 3.5-30 Alternative Cost Estimate and LCR Requirement

Alternatives	Submitted By	Estimated Cost (\$M)	Requirement (MW)			
			Total	Market Gas	Other Gas	Non-Gas
Reconductor nine 115 kV lines (~85 miles)	ISO	200	196	0	196	0
~600 MW of preferred resource / storage	ISO	TBD	100-700	0	100	0-600
With 4-terminal DC (2000-350-300-1350)& 500 MVAR Reactive Support	ISO	\$1B+	209	0	209	0
With 4-terminal DC (2000-350-300-1350), 500 MVAR Reactive Support & Eight SVP connecting Facility Upgrade	ISO	\$1B+	0	0	0	0

3.5.5.4 South Bay-Moss Landing Sub-area

South Bay-Moss Landing is a Sub-area of the Greater Bay LCR Area.

3.5.5.4.1 South Bay-Moss Landing LCR Sub-area Diagram

The South Bay-Moss Landing LCR Sub-area is identified in Figure 3.5-30.

3.5.5.4.2 South Bay-Moss Landing LCR Sub-area Load and Resources

Table 3.5-31 provides the forecast load and resources in South Bay-Moss Landing LCR Sub-area in 2028. The list of generators within the LCR Sub-area are provided in Attachment A.

Table 3.5-31 South Bay-Moss Landing LCR Sub-area 2028 Forecast Load and Resources

Load (MW)		Generation (MW)	
Gross Load	4841	Market Gas	2159
AAEE	-294	Other Gas	202
Behind the meter DG	-117	Non-Gas	0
Net Load	4431		
Transmission Losses	124	Future preferred resource and energy storage (Resolution E-4949)	561
Pumps	0	Total Qualifying Capacity	2922
Load + Losses + Pumps	4555		

3.5.5.4.3 South Bay-Moss Landing LCR Sub-area Hourly Profiles

Figure 3.5-35 illustrates the forecast 2028 profile for the summer peak, winter peak and spring off-peak days for the South Bay-Moss Landing LCR Sub-area with the Category C (Multiple Contingency) transmission capability with no market gas. Figure 3.5-36 illustrates the forecast 2028 hourly profile for South Bay-Moss Landing LCR Sub-area with the Category C (Multiple Contingency) transmission capability with no market gas.

Figure 3.5-35 South Bay-Moss Landing LCR Sub-area 2028 Peak Day Forecast Profiles

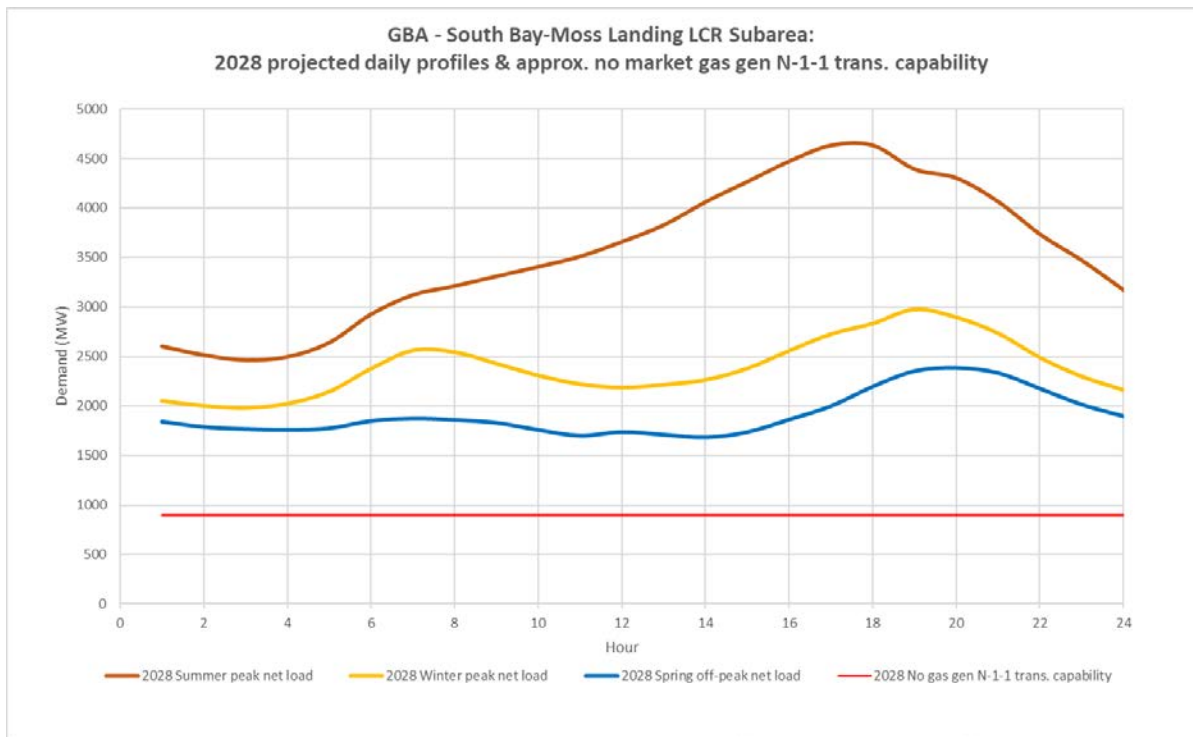
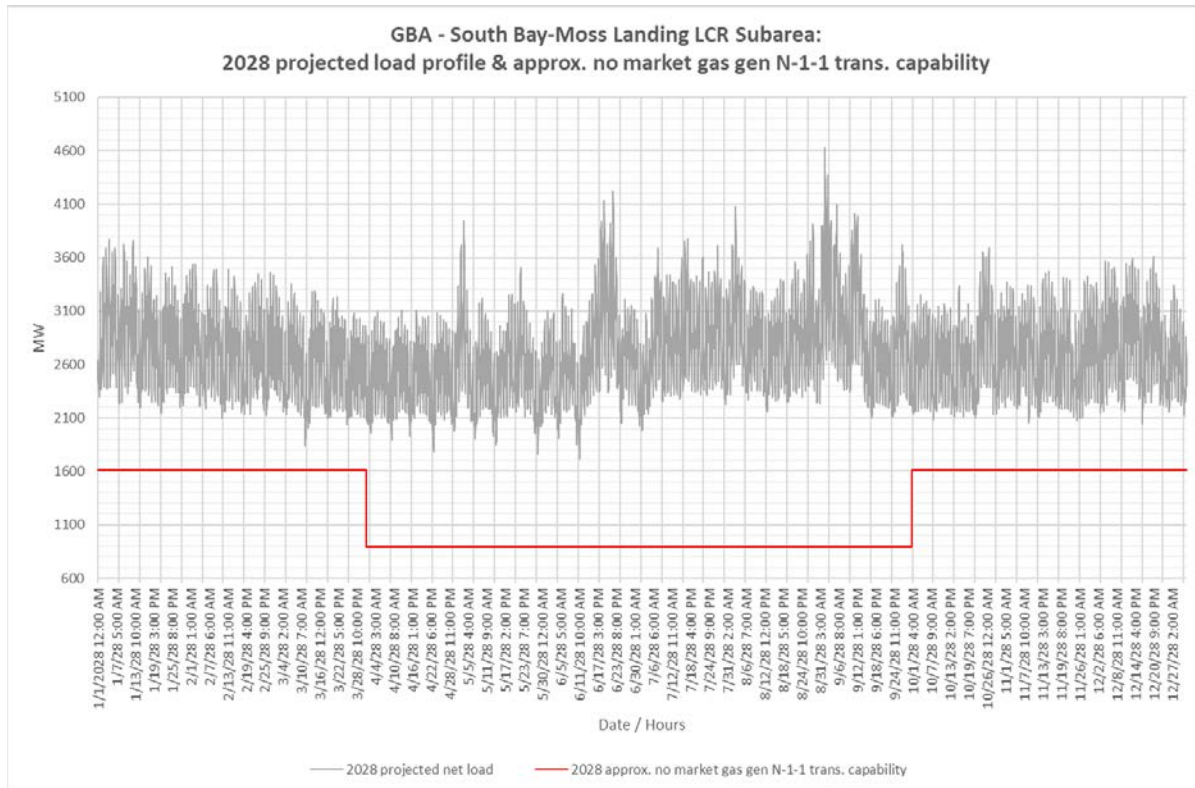

Figure 3.5-36 South Bay-Moss Landing LCR Sub-area 2028 Forecast Hourly Profiles



3.5.5.4.4 South Bay-Moss Landing LCR Sub- Requirement

Table 3.5-32 identifies the limiting facility and contingency that establishes the South Bay-Moss Landing Sub-area 2028 LCR requirements. There was no LCR requirement for Category B (Single Contingency) and the LCR Requirement for a Category C (Multiple Contingency) is 2100 MW. The second limiting facility and contingency has been provided for information only.

Table 3.5-32 South Bay-Moss Landing LCR Sub-area Requirements

Year	Limit	Category	Limiting Facility	Contingency	LCR (MW) (Deficiency)
2028	First Limit	B	None	None	0
2028	First Limit	C	Moss Landing-Las Aguilas 230 kV	Tesla-Metcalf 500 kV and Moss Landing-Los Banos 500 kV	2100
2028	Second Limit	C	Newark-NRS 115 kV	Tesla-Metcalf 500 kV and Moss Landing-Los Banos 500 kV	2010
Multiple subsequent constraints with limiting facilities within San Jose 115 kV system and extended to Tesla-Newark 230 kV lines					

3.5.5.4.5 Effectiveness factors:

Effect factors for generators in the South Bay-Moss Landing LCR Sub-area are in Attachment B table titled South Bay-Moss Landing.

For other helpful procurement information please read procedure 2210Z Effectiveness Factors under 7230 (T-165Z) posted at: <http://www.caiso.com/Documents/2210Z.pdf>

3.5.5.4.6 Alternatives to Reduce or Eliminate Gas Generation

As a part of the 2018-2019 transmission planning process the ISO undertook an assessment in approximately half of the LCR areas and LCR Sub-areas to determine potential transmission alternatives to reduce or eliminate the need for gas-fired generation to meet the LCR requirement. Alternatives in the South Bay-Moss Landing Sub-area were assessed. The following alternatives were considered.

- New Sunol 500 kV substation
- With 4-terminal DC (2000-350-300-1350) & 500 MVAR Reactive Support

Table 3.5-33 provides the LCR requirement for the alternatives identified above. For the alternatives that reduced the LCR requirement but did not eliminate the requirement, the limiting facility and contingency have been provided.

Table 3.5-33 Alternatives to Reduce or Eliminate the South Bay-Moss Landing Sub-Area Requirement for Gas-fired generation

Year	Limit	Category	Limiting Facility	Contingency	LCR (MW) (Deficiency)
New Sunol 500 kV substation					
2028	First Limit	C	Thermal overload of Newark-NRS 115 kV	Tesla-Metcalf 500 kV and Tesla-Sunol 500 kV	769
With 4-terminal DC (2000-350-300-1350) & 500 MVAR Reactive Support					
2028	First Limit	C	Thermal overload of Moss Landing-Las Aguilas 230 kV	Tesla-Metcalf 500 kV and Moss Landing-Los Banos 500 kV	534

Table 3.5-34 provides the cost estimates and the total South Bay-Moss Landing LCR Sub-area requirement and portion of requirement that would need to be supplied from gas-fired and non gas generation for the alternatives identified above

Table 3.5-34 Alternative Cost Estimate and LCR Requirement

Alternatives	Submitted By	Estimated Cost (\$M)	Requirement (MW)			
			Total	Market Gas	Other Gas	Non-Gas
New Sunol 500 kV substation	PGE	\$500M-\$1B	763	0	202	561
With 4-terminal DC (2000-350-300-1350), 500 MVAR Reactive Support at	ISO	\$1B+	534	0	0	534

3.5.5.5 **Oakland Sub-area**

Oakland is a Sub-area of the Greater Bay LCR Area.

3.5.5.5.1 **Oakland LCR Sub-area Diagram**

Figure 3.5-37 Oakland LCR Sub-area

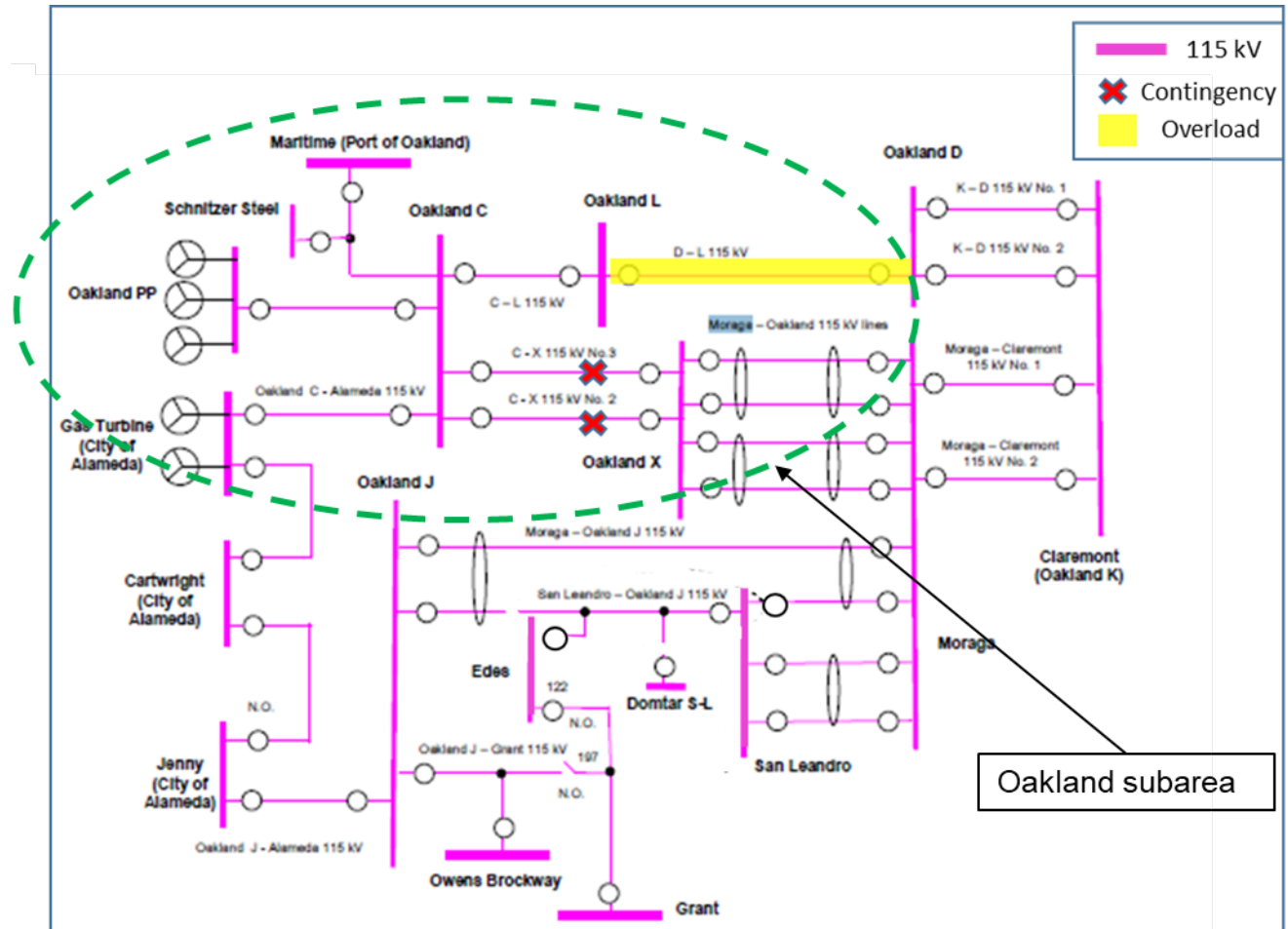

3.5.5.5.2 **Oakland LCR Sub-area Load and Resources**

Table 3.5-35 provides the forecast load and resources in Oakland LCR Sub-area in 2028. The list of generators within the LCR Sub-area are provided in Attachment A.

Table 3.5-35 Oakland LCR Sub-area 2028 Forecast Load and Resources

Load (MW)		Generation (MW)	
Gross Load	208	Market Gas	0
AEE	-15	Other Gas	49
Behind the meter DG	-6	Non-Gas	165
Net Load	187		
Transmission Losses	0		
Pumps	0	Total Qualifying Capacity	214
Load + Losses + Pumps	187		

3.5.5.5.3 Oakland LCR Sub-area Hourly Profiles

Figure 3.5-38 illustrates the forecast 2028 profile for the summer peak, winter peak and spring off-peak days for the Oakland LCR Sub-area with the Category C (Multiple Contingency) transmission capability with no market gas. Figure 3.5-39 illustrates the forecast 2028 hourly profile for Oakland LCR Sub-area with the Category C (Multiple Contingency) transmission capability with no market gas.

Figure 3.5-38 Oakland LCR Sub-area 2028 Peak Day Forecast Profiles

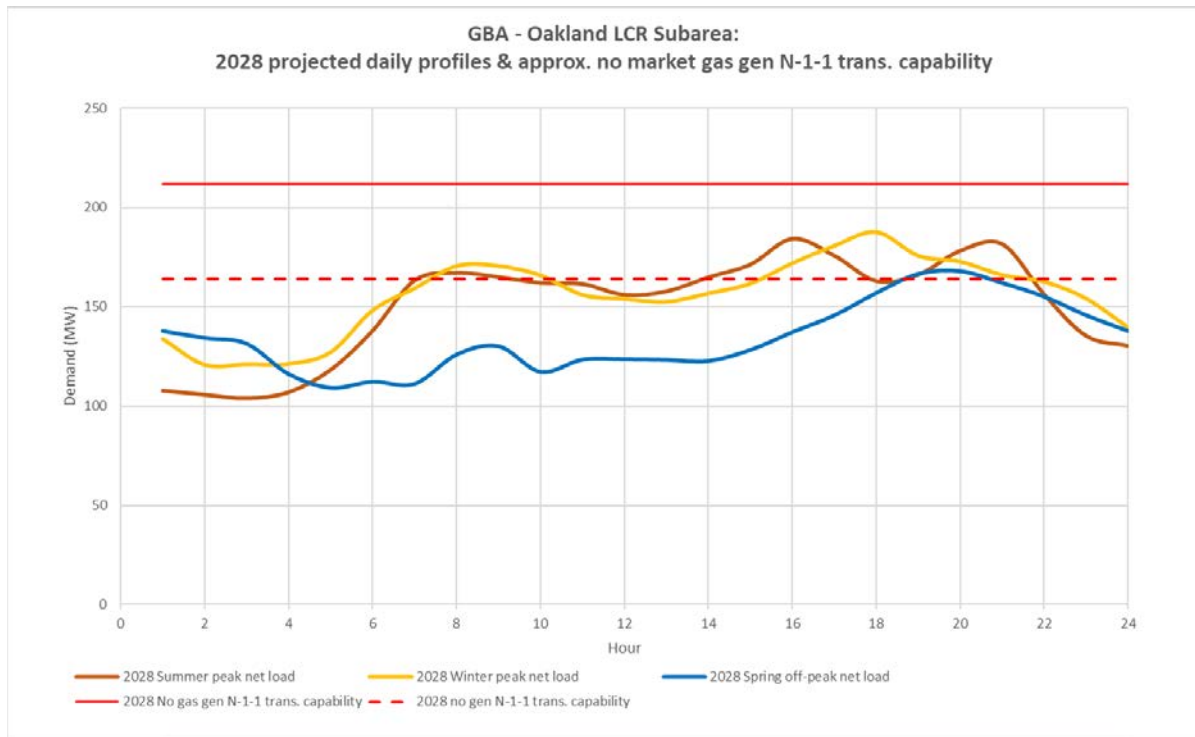
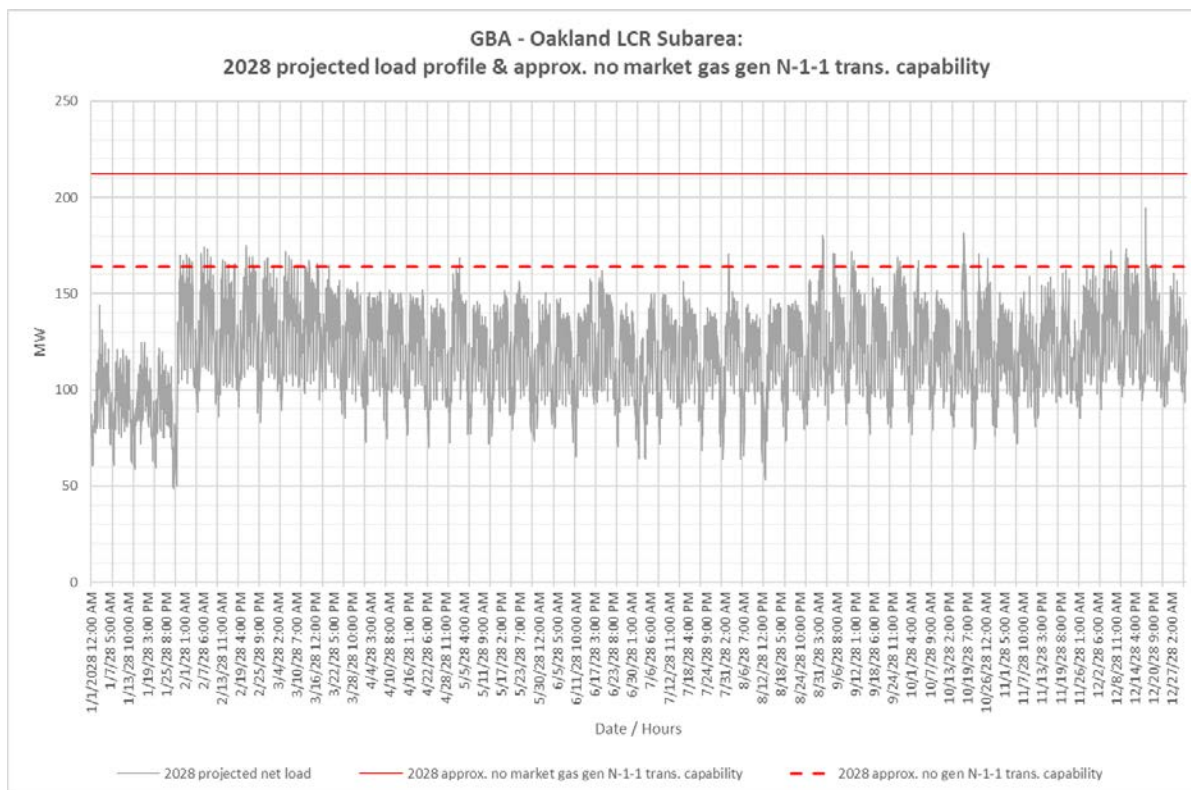

Figure 3.5-39 Oakland LCR Sub-area 2028 Forecast Hourly Profiles



3.5.5.5.4 Oakland LCR Sub-area Requirement

Table 3.5-36 identifies the Oakland 2028 LCR Sub-area requirements. There was no LCR requirement for Category B (Single Contingency) and the LCR Requirement for a Category C (Multiple Contingency) is 14 MW. The second limiting facility and contingency has been provided for information only.

Table 3.5-36 Oakland LCR Sub-area Requirements

Year	Limit	Category	Limiting Facility	Contingency	LCR (MW) (Deficiency)
2028	First limit	B	None	None	0
2028	First limit	C	Oakland D-L 115 kV cable	Oakland C-X #2 & #3 115 kV	14
2028	Second limit	C	Oakland C-X #2 115 kV cable	Oakland D-L & C-X #3 115 kV	13

3.5.5.5.5 Effectiveness factors:

All units within the Oakland Sub-area have the same effectiveness factor.

For most helpful procurement information please read procedure 2210Z Effectiveness Factors under 7110 (T-138Z) posted at: <http://www.caiso.com/Documents/2210Z.pdf>

3.5.5.5.6 Alternatives to Reduce or Eliminate Gas Generation

As a part of the 2018-2019 transmission planning process the ISO undertook an assessment in approximately half of the LCR areas and LCR Sub-areas to determine potential transmission alternatives to reduce or eliminate the need for gas-fired generation to meet the LCR requirement. In the 2018-2019 transmission planning process the Oakland LCR Sub-area was not selected to assess alternatives to reduce or eliminate the requirement for gas-fired generation to address the LCR requirement.

3.5.5.6 Ames-Pittsburg-Oakland Sub-areas Combined

Ames-Pittsburg-Oakland is a Sub-area of the Greater Bay LCR Area.

3.5.5.6.1 Ames-Pittsburg-Oakland LCR Sub-area Diagram

Figure 3.5-40 Ames-Pittsburg-Oakland LCR Sub-area

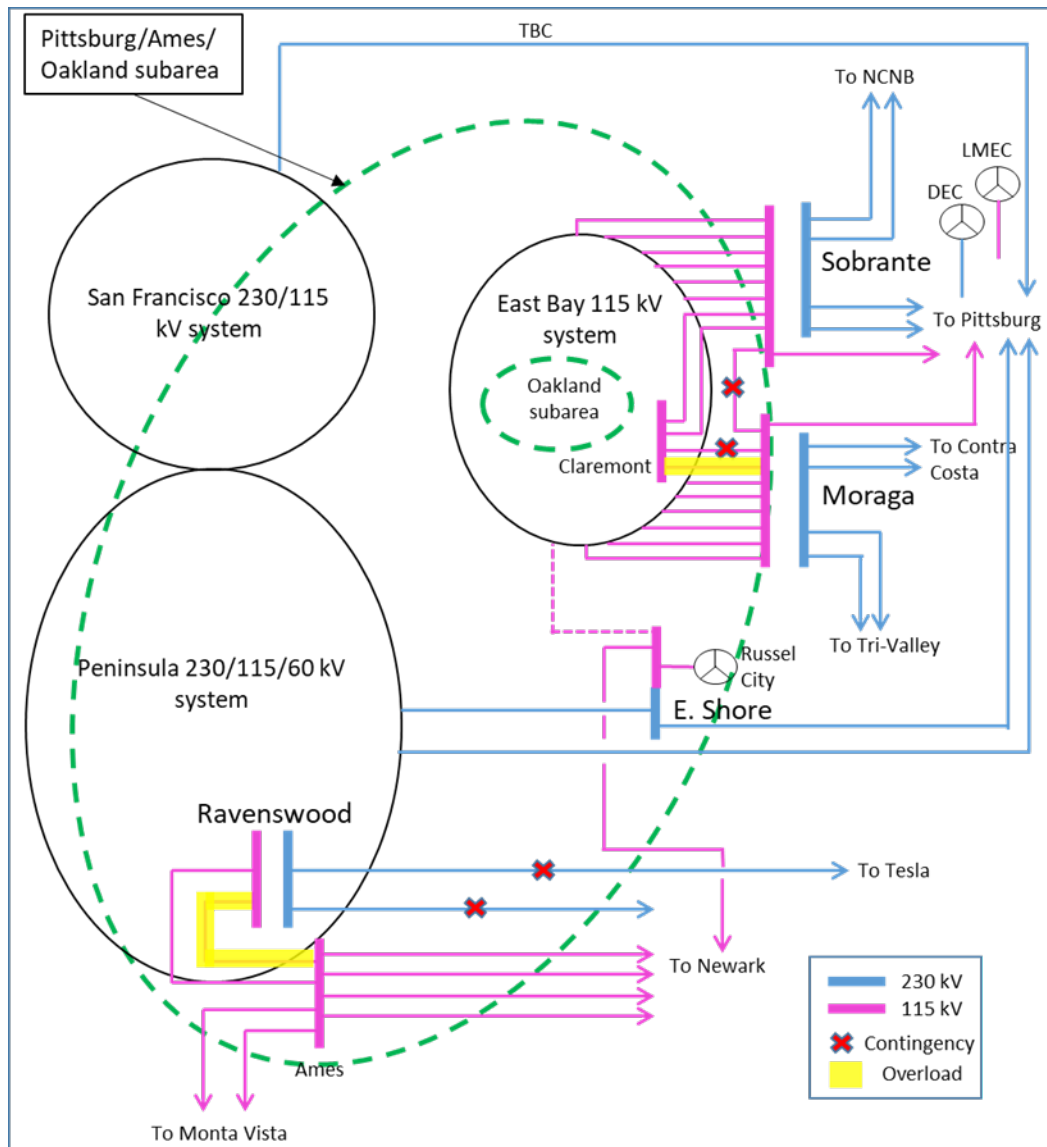

3.5.5.6.2 Ames-Pittsburg-Oakland LCR Sub-area Load and Resources

Table 3.5-37 provides the forecast load and resources in Ames-Pittsburg-Oakland LCR Sub-area in 2028. The list of generators within the LCR Sub-area are provided in Attachment A.

Table 3.5-37 Ames-Pittsburg-Oakland LCR Sub-area 2028 Forecast Load and Resources

Load (MW)	Generation (MW)	
The Ames-Pittsburg-Oakland Sub-area does not has a defined load pocket with the limits based upon power flow through the area.	Market Gas	2002
	Other Gas	279
	Non-Gas	198
	Future preferred resource and energy storage (Resolution E-4949)	0
	Total Qualifying Capacity	2479

3.5.5.6.3 Ames-Pittsburg-Oakland LCR Sub-area Hourly Profiles

The Ames-Pittsburg-Oakland Sub-area does not has a defined load pocket with the limits based upon power flow through the area. There are two limiting paths within the Ames-Pittsburg-Oakland Sub-area, Moraga-Claremont #2 115 kV line and Ames-Ravenswood #1 115 kV line.

Figure 3.5-41 illustrates the 2017 Category C (Multiple Contingency) post contingency flows on the limiting facility (Moraga-Claremont #2 115 kV line) for the summer peak, winter peak and spring off-peak days for the Ames-Pittsburg-Oakland Sub-area transmission capability with no market gas. Figure 3.5-42 illustrates the 2017 hourly profile of the Category C (Multiple Contingency) post contingency flows on the limiting facility (Moraga-Claremont #2 115 kV line) for Ames-Pittsburg-Oakland LCR Sub-area with no market gas.

Figure 3.5-43 illustrates the 2017 Category C (Multiple Contingency) post contingency flows on the limiting facility (Ames-Ravenswood #1 115 kV line) for the summer peak, winter peak and spring off-peak days for the Ames-Pittsburg-Oakland Sub-area transmission capability with no market gas. Figure 3.5-44 illustrates the 2017 hourly profile of the Category C (Multiple Contingency) post contingency flows on the limiting facility (Ames-Ravenswood #1 115 kV line) for Ames-Pittsburg-Oakland LCR Sub-area with no market gas.

Figure 3.5-41 Ames-Pittsburg-Oakland LCR Sub-area 2017 Limiting Post Contingency Peak Day Profiles (Moraga-Claremont #2 115 kV line)

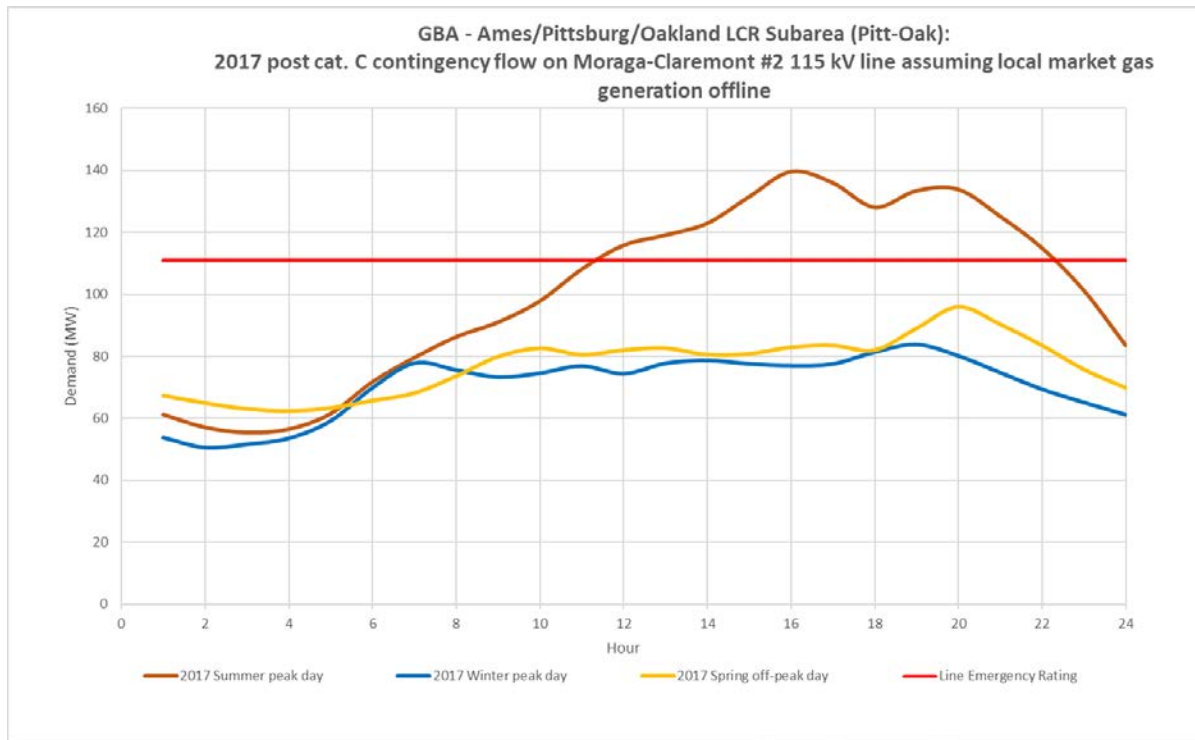

Figure 3.5-42 Ames-Pittsburg-Oakland LCR Sub-area 2017 Limiting Post Contingency Hourly Profiles (Moraga-Claremont #2 115 kV line)

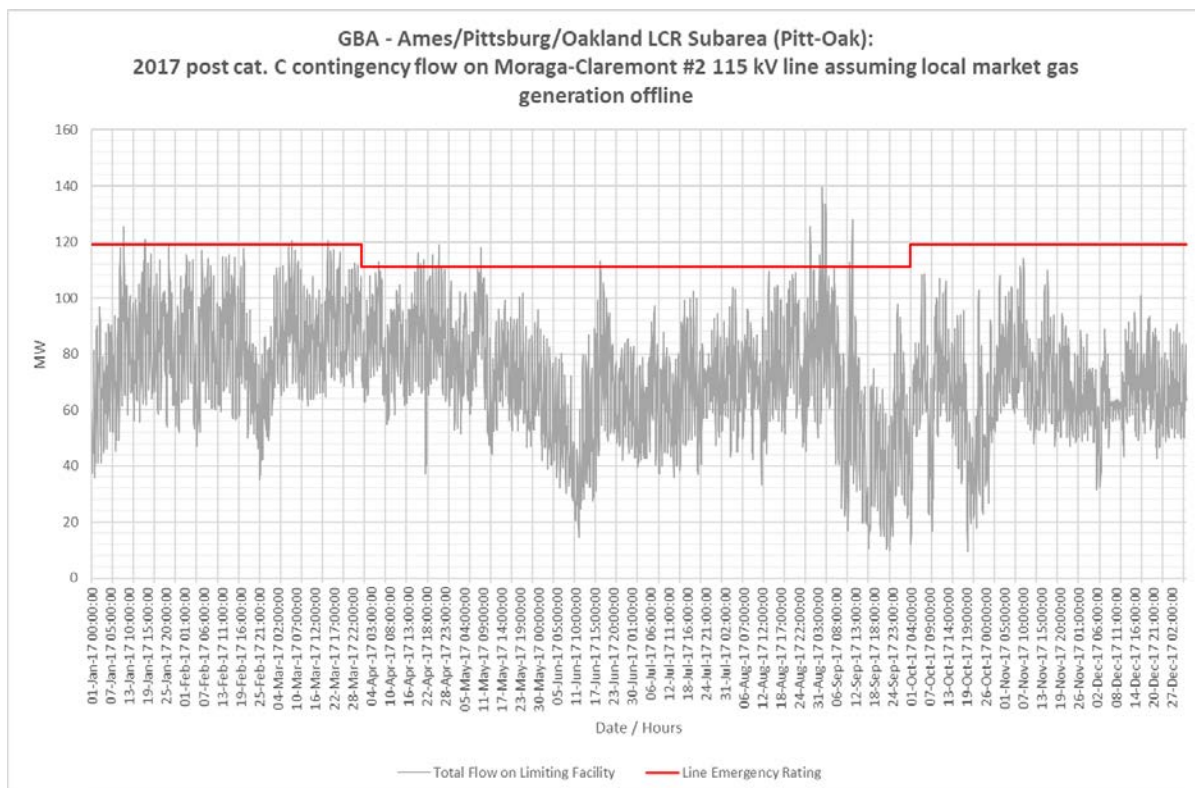

Figure 3.5-43 Ames-Pittsburg-Oakland LCR Sub-area 2017 Limiting Post Contingency Peak Day Profiles (Ames-Ravenswood #1 115 kV line)

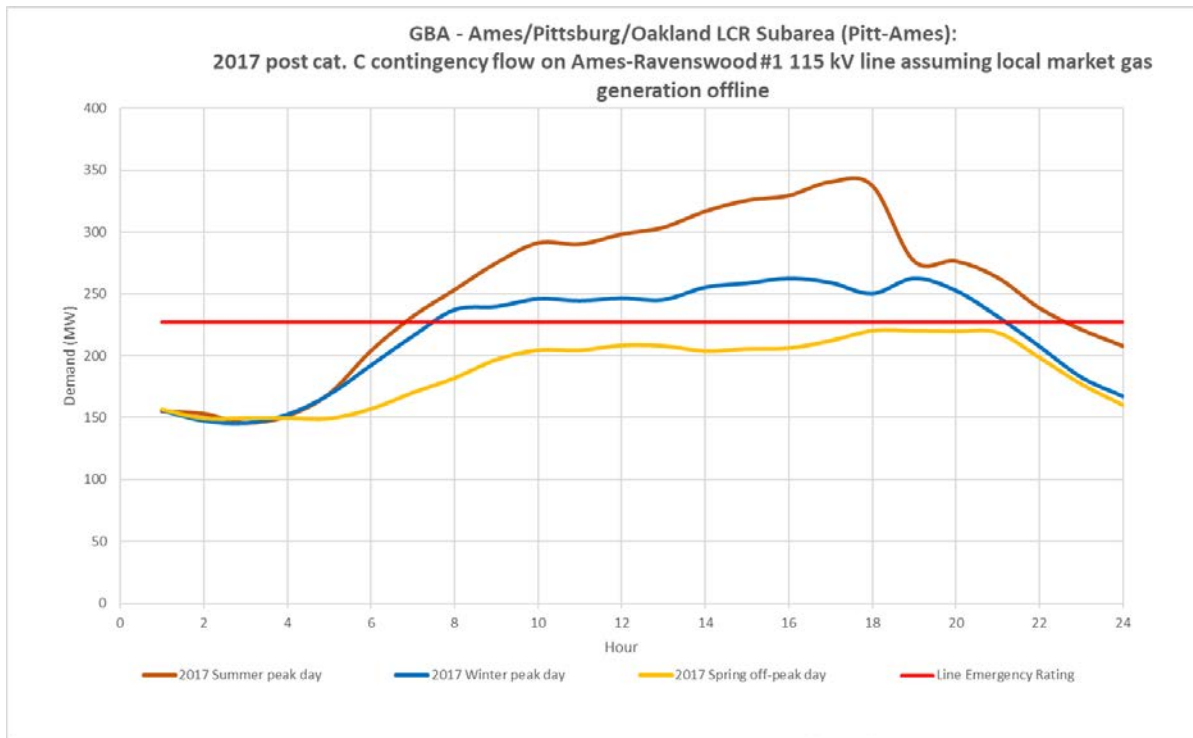
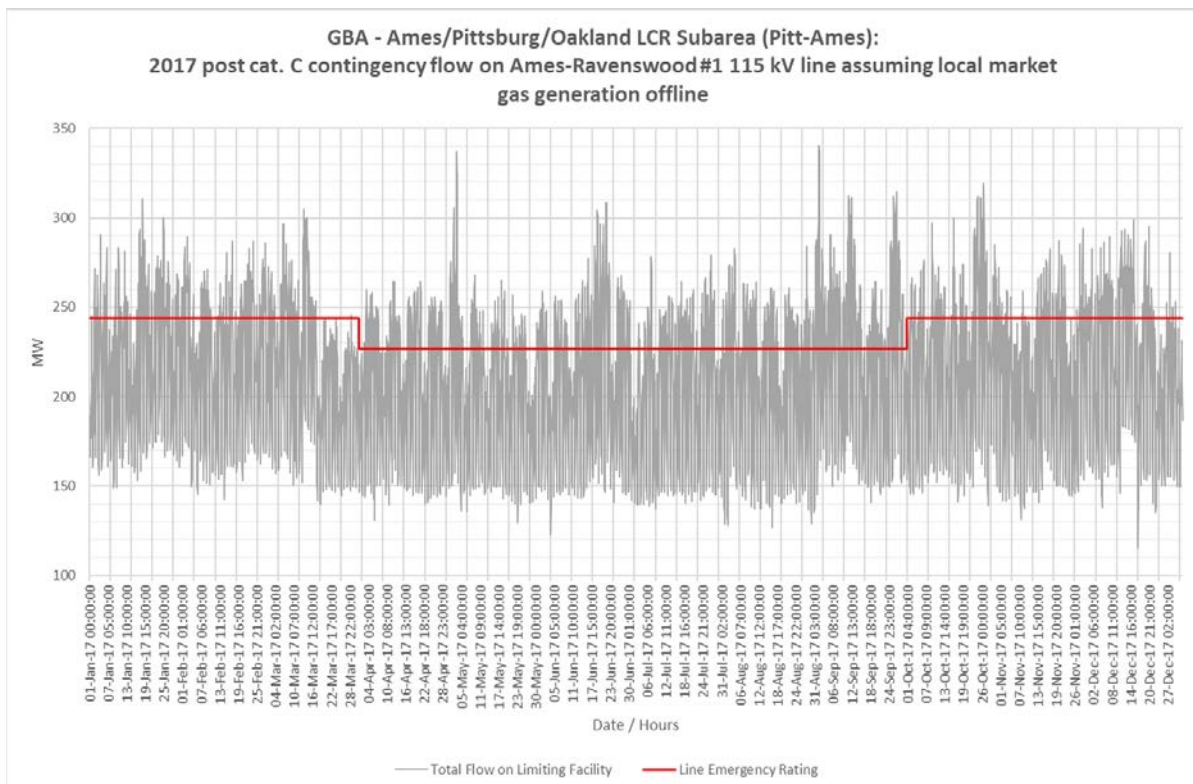

Figure 3.5-44 Ames-Pittsburg-Oakland LCR Sub-area 2017 Limiting Post Contingency Hourly Profiles (Ames-Ravenswood #1 115 kV line)



3.5.5.6.4 Ames-Pittsburg-Oakland LCR Sub-area Requirement

Table 3.5-38 identifies the limiting facility and contingency that establishes the Ames-Pittsburg-Oakland Sub-area 2028 LCR requirements. There was no LCR requirement for Category B (Single Contingency) and the LCR Requirement for a Category C (Multiple Contingency) is 2237 MW. The second limiting facility and contingency has been provided for information only.

Table 3.5-38 Ames-Pittsburg-Oakland LCR Sub-area Requirements

Year	Limit	Category	Limiting Facility	Contingency	LCR (MW) (Deficiency)
2028	First limit	B	None	None	0
2028	First limit	C	Monta Vista-Mountain View 115 kV	Whisman-Mountain View 115 kV and Jefferson-Martin 230 kV	2237
2028	Second limit	C	Ames-Ravenswood #1 115 kV line	Newark-Ravenswood 230 kV & Tesla-Ravenswood 230 kV	2022
			Moraga-Claremont #2 115 kV line	Moraga-Sobrante 115 kV & Moraga-Claremont #1 115 kV	
2028	Third limit	C	Newark-Ames 115 kV lines	Newark-Ravenswood 230 kV & Tesla-Ravenswood 230 kV	1432
2028	Fourth limit	C	Moraga-Sobrante 115 kV and Tesla-Newark 230 kV	Tesla-Pittsburg #1 & #2 230 kV	1336
Multiple subsequent constraints with limiting facilities within the San Jose 115 kV system					

3.5.5.6.5 Effectiveness factors:

Effectiveness factors for generators in the Ames-Pittsburg-Oakland LCR Sub-area are in Attachment B table titled Ames-Pittsburg-Oakland.

For other helpful procurement information please read procedure 2210Z Effectiveness Factors under 7230 (T-165Z) posted at: <http://www.caiso.com/Documents/2210Z.pdf>

3.5.5.6.6 Alternatives to Reduce or Eliminate Gas Generation

As a part of the 2018-2019 transmission planning process the ISO undertook an assessment in approximately half of the LCR areas and LCR Sub-areas to determine potential transmission alternatives to reduce or eliminate the need for gas-fired generation to meet the LCR requirement. Alternatives in the Ames-Pittsburg-Oakland Sub-area were assessed. The following alternatives were considered.

- Collinsville 500 kV substation
- Collinsville plus Monta Vista-Mountain View-Whisman and Moraga-Claremont 115 kV lines upgrade
- Collinsville 500 kV substation, Moraga-Claremont and Moraga-Sobrante 115 kV lines upgrade and 600 MW storage in Peninsula (or 600 MW HVDC from Pittsburg to Peninsula)

Table 3.5-39 provides the LCR requirement for the alternatives identified above. For the alternatives that reduced the LCR requirement but did not eliminate the requirement, the limiting facility and contingency have been provided.

Table 3.5-39 Alternatives to Reduce or Eliminate the Ames-Pittsburg-Oakland Sub-Area Requirement for Gas-fired generation

Year	Limit	Category	Limiting Facility	Contingency	LCR (MW) (Deficiency)
Collinsville 500 kV substation					
2028	First limit	C	Monta Vista-Mountain View 115 kV line	Whisman-Mountain View 115 kV and Jefferson-Martin 230 kV	970
Collinsville plus Monta Vista-Mountain View-Whisman and Moraga-Claremont 115 kV lines upgrade					
2028	First limit	C	Ames-Ravenswood 115 kV & Oakland J-E. Shore 115 kV	Newark-Ravenswood 230 kV & Tesla-Ravenswood 230 kV	450
Collinsville 500 kV substation, Moraga-Claremont and Moraga-Sobrante 115 kV lines upgrade and 600 MW storage in Peninsula (or 600 MW HVDC from Pittsburg to Peninsula)					
2028	First limit	C	Tesla-Newark #1 & #2 230 kV	Tesla-Pittsburg #1 & #2 230 kV	0-600

Table 3.5-40 provides the cost estimates and the total Ames-Pittsburg-Oakland LCR Sub-area requirement and portion of requirement that would need to be supplied from gas-fired and non gas generation for the alternatives identified above

Table 3.5-40 Alternative Cost Estimate and LCR Requirement

Alternatives	Submitted By	Estimated Cost (\$M)	Requirement (MW)			
			Total	Market Gas	Other Gas	Non-Gas
Collinsville 500 kV substation	PGE	\$0.5B-\$1B	970	493	279	198
Collinsville plus Monta Vista-Mountain View-Whisman and Moraga-Claremont 115 kV lines upgrade	PGE, ISO	\$1B+	450	0	252	198
Collinsville 500 kV substation, Moraga-Claremont and Moraga-Sobrante 115 kV lines upgrade and 600 MW storage in Peninsula (or 600 MW HVDC from Pittsburg to Peninsula)	PGE, ISO	\$1B+	0-600	0	0	0-600

3.5.5.7 **Contra Costa Sub-area**

Contra Costa is a Sub-area of the Greater Bay LCR Area.

3.5.5.7.1 **Contra Costa LCR Sub-area Diagram**

Figure 3.5-45 Contra Costa LCR Sub-area

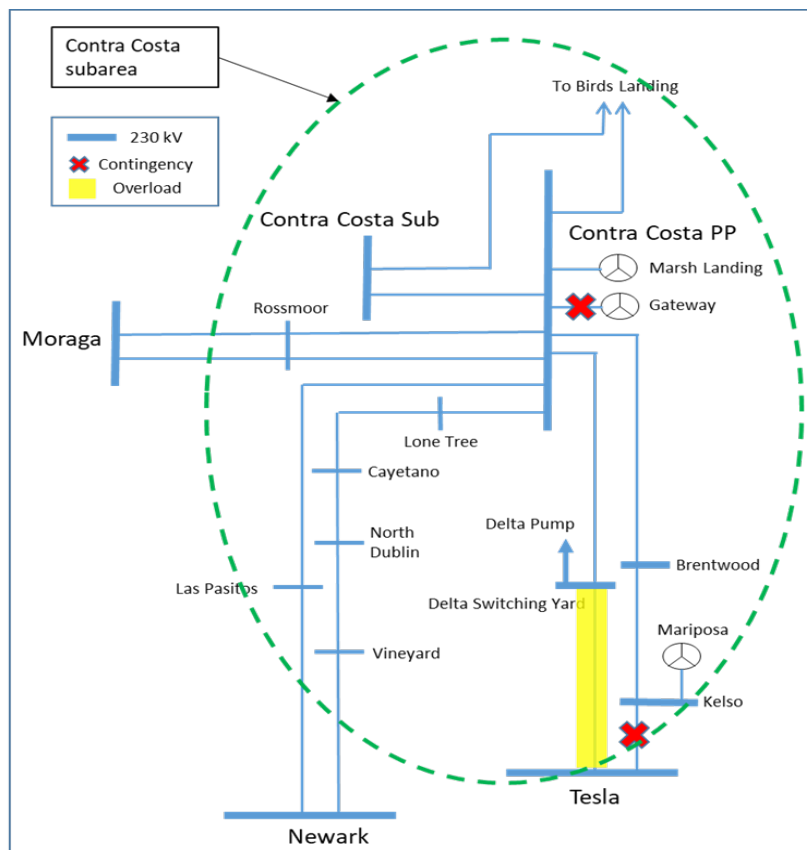

3.5.5.7.2 Contra Costa LCR Sub-area Load and Resources

Table 3.5-41 provides the forecast load and resources in Contra Costa LCR Sub-area in 2028. The list of generators within the LCR Sub-area are provided in Attachment A.

Table 3.5-41 Contra Costa LCR Sub-area 2028 Forecast Load and Resources

Load (MW)	Generation (MW)	
The Ames-Pittsburg-Oakland Sub-area does not has a defined load pocket with the limits based upon power flow through the area.	Market Gas	1717
	Other Gas	0
	Non-Gas	454
	Future preferred resource and energy storage (Resolution E-4949)	0
	Total Qualifying Capacity	2171

3.5.5.7.3 Contra Costa LCR Sub-area Hourly Profiles

The Contra Costa Sub-area does not has a defined load pocket with the limits based upon power flow through the area.

Figure 3.5-46 illustrates the 2017 Category C (Multiple Contingency) post contingency flows on the limiting facility for the summer peak, winter peak and spring off-peak days for the Contra Costa Sub-area transmission capability with no market gas. Figure 3.5-47 illustrates the 2017 hourly profile of the Category C (Multiple Contingency) post contingency flows on the limiting facility for Contra Costa LCR Sub-area with no market gas.

Figure 3.5-46 Contra Costa LCR Sub-area 2017 Limiting Post Contingency Peak Day Profiles

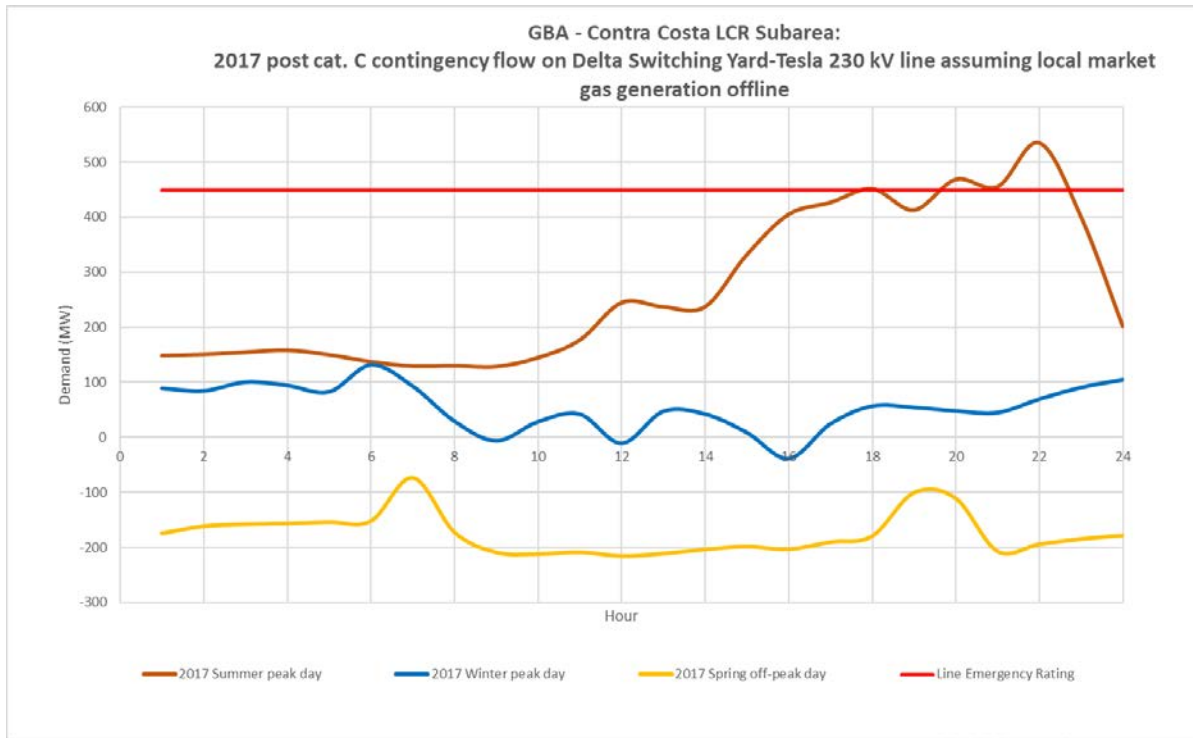
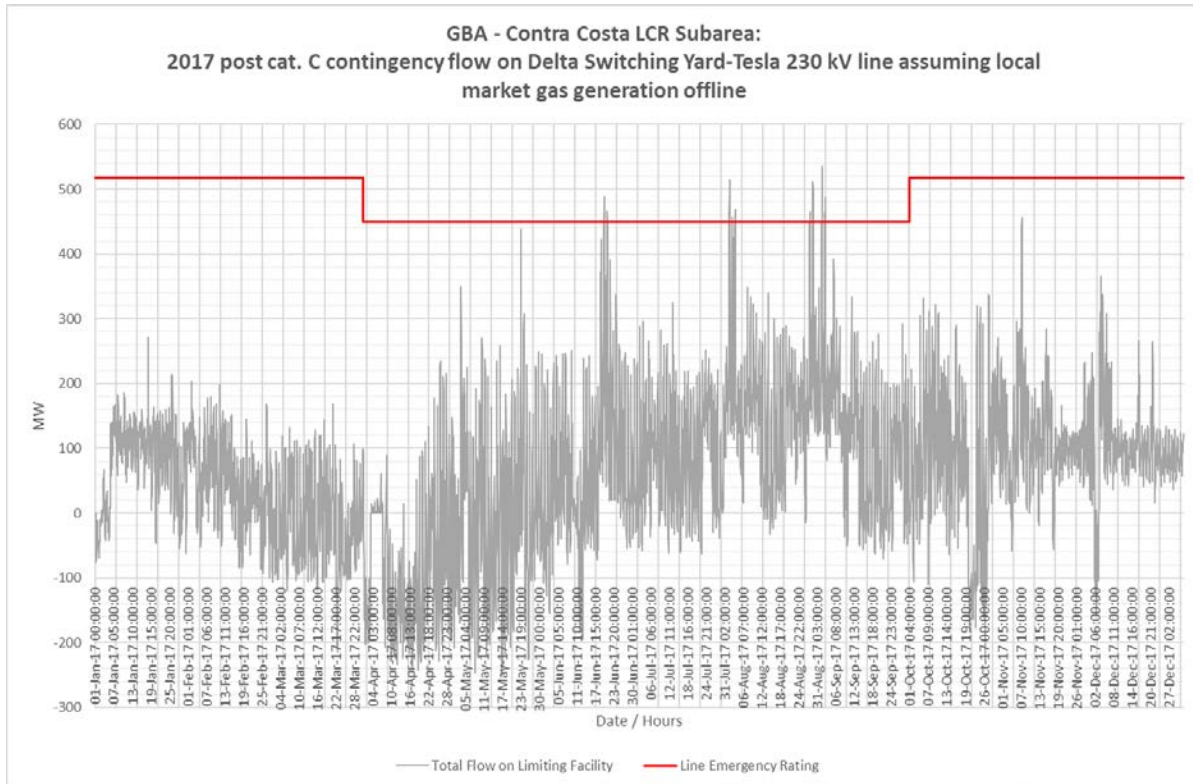

Figure 3.5-47 Contra Costa LCR Sub-area 2017 Limiting Post Contingency Hourly Profiles



3.5.5.7.4 Contra Costa LCR Sub-area Requirement

Table 3.5-42 identifies the limiting facility and contingency that establishes the Contra Costa Sub-area 2028 LCR requirements. The LCR requirement for Category B (Single Contingency) is 1274 MW and the LCR Requirement for a Category C (Multiple Contingency) is same as category B.

Table 3.5-42 Contra Costa LCR Sub-area Requirements

Year	Limit	Category	Limiting Facility	Contingency	LCR (MW) (Deficiency)
2028	First limit	B/C	Delta Switching Yard-Tesla 230 kV	Kelso-Tesla 230 kV line and Gateway unit	1274

3.5.5.7.5 Effectiveness factors:

Effectic factors for generators in the Contra Costa LCR Sub-area are in Attachment B table titled Contra Costa.

For other helpful procurement information please read procedure 2210Z Effectiveness Factors under 7230 (T-165Z) posted at: <http://www.caiso.com/Documents/2210Z.pdf>

3.5.5.7.6 Alternatives to Reduce or Eliminate Gas Generation

As a part of the 2018-2019 transmisson planning process the ISO undertook an assessment in approximately half of the LCR areas and LCR Sub-areas to determine potential transmission alternatives to reduce or eliminate the need for gas-fired generation to meet the LCR requirement. In the 2018-2019 transmission planning process the Contra Costa LCR Sub-area was not selected to assess alternatives to reduce or eliminate the requirement for gas-fired generation to address the LCR requirement.

3.5.5.8 Bay Area overall

3.5.5.8.1 Greater Bay LCR Area Overall Requirement

Table 3.5-43 identifies the limiting facility and contingency that establishes the Tesla-Belota Sub-area 2028 LCR requirements. The LCR requirement for Category B (Single Contingency) is 4795 MW and for Category C (Multiple Contingency) is 5600 MW with a 204 MW deficiency. The Category C (Multiple Contingency) is based upon the aggregate of the Sub-areas

Table 3.5-43 Tesla-Bellota LCR Sub-area Requirements

Year	Limit	Category	Limiting Facility	Contingency	LCR (MW) (Deficiency)
2028	First limit	B	Reactive margin	Tesla-Metcalf 500 kV line & DEC unit	4795
2028	First Limit	C	Aggregate of Sub-area requirements.		5600 (204)

3.5.5.8.2 Changes compared to 2023 requirements

Compared with 2023 the load forecast increased by 705 MW. The LCR need has increased by 848 MW mainly due to load increase.

3.5.5.8.3 Alternatives to Reduce or Eliminate Gas Generation

As a part of the 2018-2019 transmission planning process the ISO undertook an assessment in approximately half of the LCR areas and LCR Sub-areas to determine potential transmission alternatives to reduce or eliminate the need for gas-fired generation to meet the LCR requirement. An Alternative for the Greater Bay LCR Area were assessed based upon the alternatives considered from the Sub-area assessments. The following alternative was considered.

- With 4-terminal DC (2000-350-300-1350), 500 MVAR Reactive Support at Metcalf, Collinsville 500 kV substation, Moraga-Claremont and Moraga-Sobrante 115 kV lines upgrade and 600 MW storage in Peninsula (or 600 MW HVDC from Pittsburg to Peninsula)

Table 3.5-44 provides the LCR requirement for the alternatives identified above. For the alternatives that reduced the LCR requirement but did not eliminate the requirement, the limiting facility and contingency have been provided.

Table 3.5-44 Alternative to Reduce or Eliminate Greater Bay Requirement for Gas-fired generation

Year	Limit	Category	Limiting Facility	Contingency	LCR (MW) (Deficiency)
With 4-terminal DC (2000-350-300-1350), 500 MVAR Reactive Support at Metcalf, Collinsville 500 kV substation, Moraga-Claremont and Moraga-Sobrante 115 kV lines upgrade and 600 MW storage in Peninsula (or 600 MW HVDC from Pittsburg to Peninsula)					
2028	First limit	A	Reactive Margin		2500
2028	First limit	C	Moss Landing-Las Aguilas 230 kV	Tesla-Metcalf 500 kV & Moss Landing-Los Banos 500 kV	2570

Table 3.5-45 provides the cost estimate and the total Grater Bay LCR Area overall requirement and portion of requirement that would need to be supplied from gas-fired and non gas generation for the alternative identified above.

Table 3.5-45 Alternative Cost Estimate and LCR Requirement

Alternatives	Submitted By	Estimated Cost (\$M)	Requirement (MW)			
			Total	Market Gas	Other Gas	Non-Gas
With 4-terminal DC (2000-350-300-1350), 500 MVAR Reactive Support at Metcalf, E-4949 (ES forced), Collinsville 500 kV substation, Moraga-Claremont and Moraga-Sobrante 115 kV lines upgrade and 600 MW storage in Peninsula (or 600 MW HVDC from Pittsburg to Peninsula)	PGE, ISO	\$2B+	2570	812	485	1273

3.5.6 Greater Fresno Area

3.5.6.1 *Area Definition:*

The transmission facilities coming into the Greater Fresno area are:

- Gates-Mustang #1 230 kV
- Gates-Mustang #2 230 kV
- Gates #5 230/70 kV Transformer Bank
- Mercy Spring 230 /70 Bank # 1
- Los Banos #3 230/70 Transformer Bank
- Los Banos #4 230/70 Transformer Bank
- Warnerville-Wilson 230kV
- Melones-North Merced 230 kV line
- Panoche-Tranquility #1 230 kV
- Panoche-Tranquility #2 230 kV
- Panoche #1 230/115 kV Transformer Bank
- Panoche #2 230/115 kV Transformer Bank
- Corcoran-Smyrna 115kV
- Coalinga #1-San Miguel 70 kV

The substations that delineate the Greater Fresno area are:

- Gates is out Mustang is in
- Gates is out Mustang is in
- Gates 230 is out Gates 70 is in
- Mercy Springs 230 is out Mercy Springs 70 is in
- Los Banos 230 is out Los Banos 70 is in
- Los Banos 230 is out Los Banos 70 is in
- Warnerville is out Wilson is in
- Melones is out North Merced is in
- Panoche is out Tranquility #1 is in
- Panoche is out Tranquility #2 is in
- Panoche 230 is out Panoche 115 is in
- Panoche 230 is out Panoche 115 is in

- Corcoran is in Smyrna is out
- Coalinga is in San Miguel is out

3.5.6.1.2 Fresno LCR Area Diagram

Figure 3.5-48 Fresno LCR Area

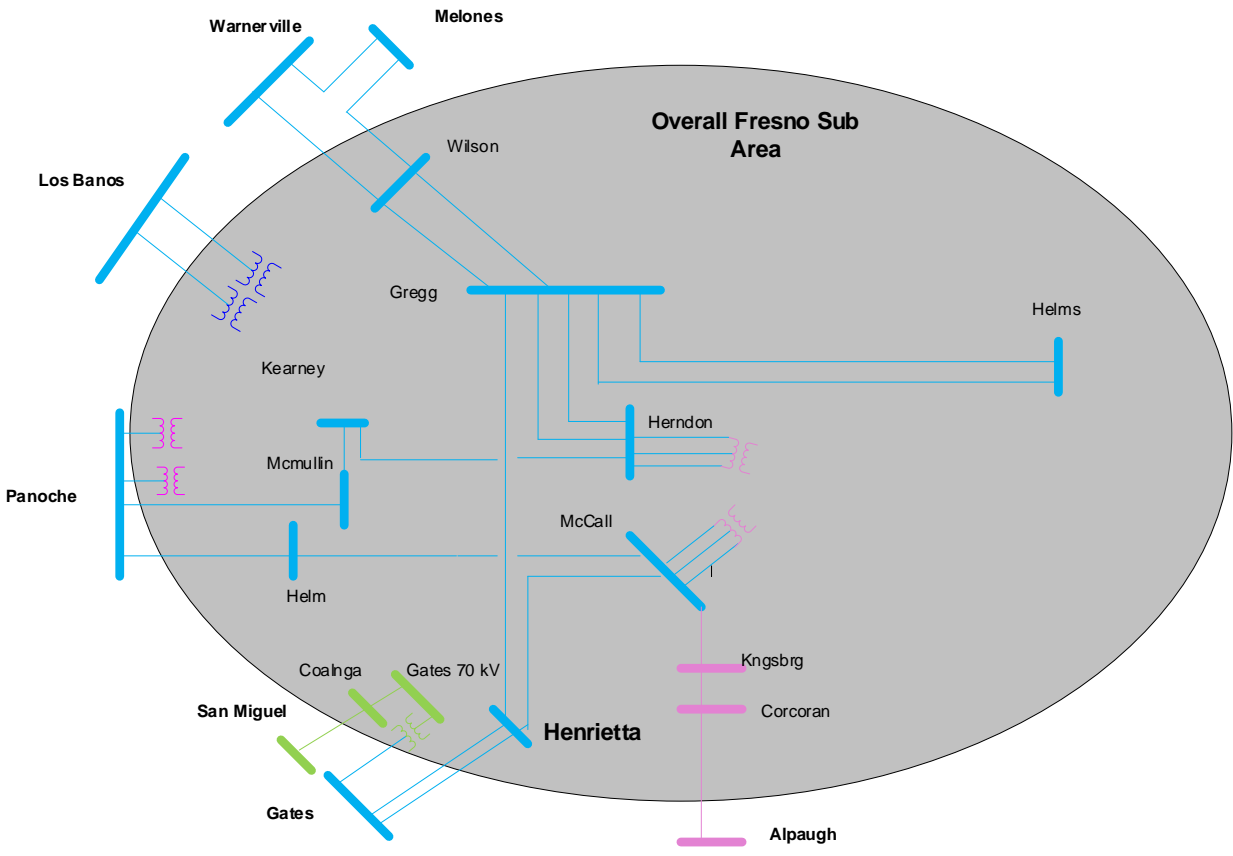

3.5.6.1.3 Fresno LCR Area Load and Resources

Table 3.5-46 provides the forecast load and resources in Fresno LCR Area in 2028. The list of generators within the LCR Sub-area are provided in Attachment A.

Table 3.5-46 Fresno LCR Area 2028 Forecast Load and Resources

Load (MW)		Generation (MW)	
Gross Load	3617	Market Gas	750
AAEE	-227	Other Gas	3
Behind the meter DG	-3	Non-Gas	2755
Net Load	3387		
Transmission Losses	109		
Pumps	0	Total Qualifying Capacity	3508
Load + Losses + Pumps	3496		

3.5.6.1.4 Approved transmission projects modeled

- Borden 230 kV Voltage Support (Feb 2019)
- Kearney-Hearndon 230 kV Line Reconductoring (May 2019)
- Gates #12 500/230 Transformer Bank addition (Dec 2019)
- Wilson 115 kV SVC (Dec 2019)
- Northern Fresno 115 kV Reinforcement (Revised scope – Mar 2020)
- Wilson-Legrand 115 kV Reconductoring (Dec 2020)
- Panoche-Oro Loma 115 kV Reconductoring (Dec 2020)
- Oro Loma 70 kV Reinforcement (May 2020)
- Reedley 70 kV Reinforcement Projects (Dec 2021)
- Herndon-Bullard Reconductoring Projects (Jan 2021)
- Wilson 115 kV Area Reinforcement (Dec 2023)
- Bellota-Warnerville 230 kV Line Reconductoring (Dec 2023)

3.5.6.2 **Hanford Sub-area**

Hanford is a Sub-area of the Fresno LCR Area.

3.5.6.2.1 **Hanford LCR Sub-area Diagram**

Figure 3.5-49 Hanford LCR Sub-area

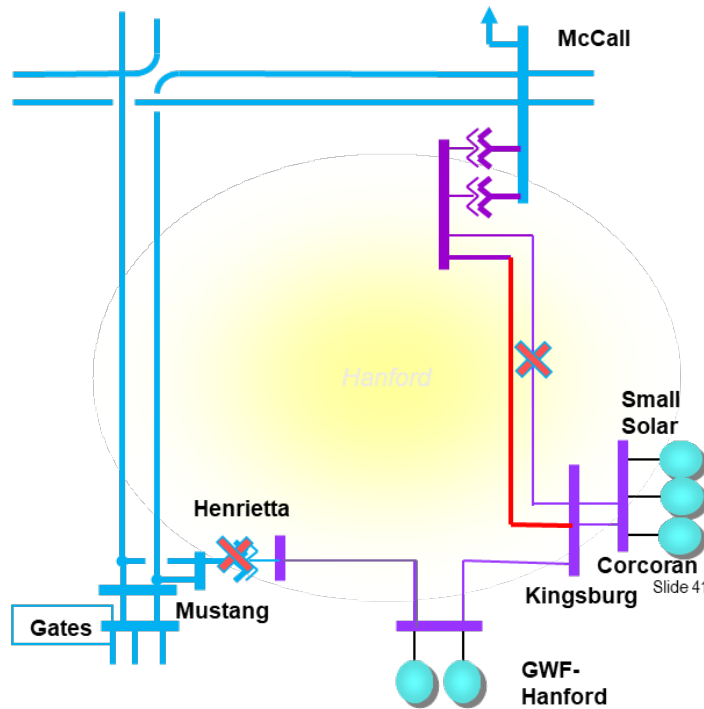

3.5.6.2.2 **Hanford LCR Sub-area Load and Resources**

Table 3.5-47 provides the forecast load and resources in Hanford LCR Sub-area in 2028. The list of generators within the LCR Sub-area are provided in Attachment A.

Table 3.5-47 Hanford LCR Sub-area 2028 Forecast Load and Resources

Load (MW)		Generation (MW)	
Gross Load	255	Market Gas	98
AAEE	-15	Other Gas	35
Behind the meter DG	-3	Non-Gas	104
Net Load	237		
Transmission Losses	5		
Pumps	0	Total Qualifying Capacity	237
Load + Losses + Pumps	242		

3.5.6.2.3 Hanford LCR Sub-area Hourly Profiles

Figure 3.5-50 illustrates the forecast 2028 profile for the summer peak, winter peak and spring off-peak days for the Hanford LCR Sub-area with the Category C (Multiple Contingency) transmission capability with no market gas. Figure 3.5-51 illustrates the forecast 2028 hourly profile for Hanford LCR Sub-area with the Category C (Multiple Contingency) transmission capability with no market gas. The red dotted line in the figures represents the transmission capability with no market gas and the solar output in the area output of zero MW.

Figure 3.5-50 Hanford LCR Sub-area 2028 Peak Day Forecast Profiles

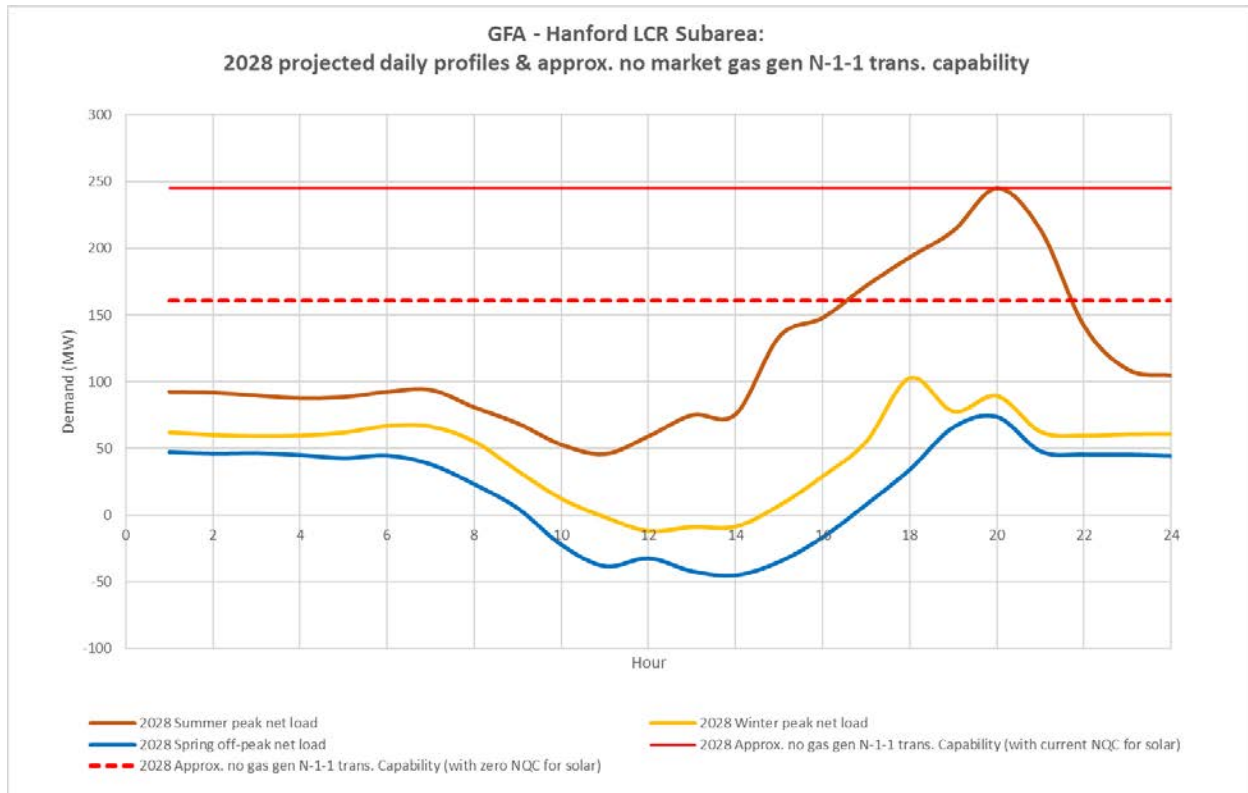
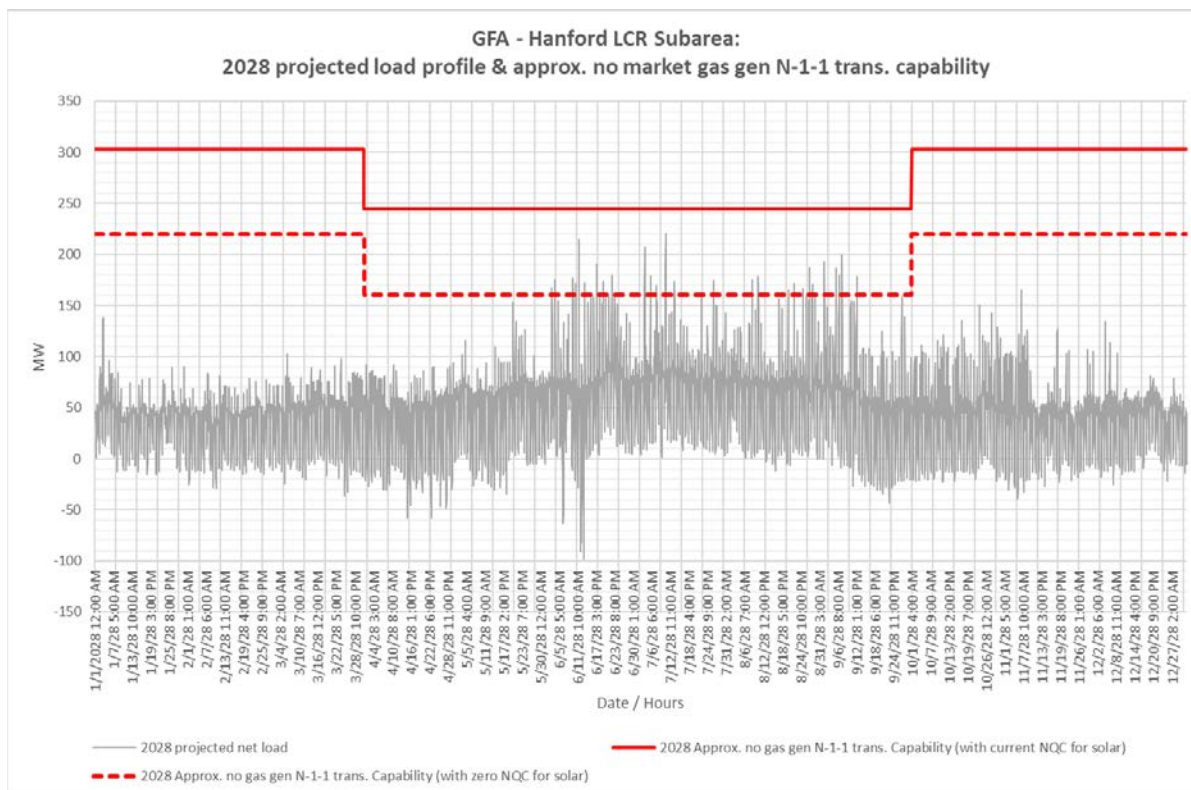

Figure 3.5-51 Hanford LCR Sub-area 2028 Forecast Hourly Profiles



3.5.6.2.4 Hanford LCR Sub-area Requirement

Table 3.5-48 identifies the Hanford 2028 LCR Sub-area requirements. There was no LCR requirement for Category B (Single Contingency) and the LCR Requirement for a Category C (Multiple Contingency) is 125 MW. The second and third limiting facility and contingency has been provided for information only.

Table 3.5-48 Hanford LCR Sub-area Requirements

Year	Limit	Category	Limiting Facility	Contingency	LCR (MW) (Deficiency)
2028	First limit	B	None	None	0
2028	First Limit	C	McCall-Kingsburg #1 115 kV	Mustang-Gates #1 and #2 230 kV	125
2028	Second Limit	C	McCall-Kingsburg #1 115 kV	McCall-Kingsburg #2 115kV & Henrietta #3 230/115kV Tx	89
2028	Third Limit	C	McCall-Kingsburg #2 115 kV	McCall-Kingsburg #1 115kV & Henrietta #3 230/115kV Tx	86

3.5.6.2.5 Effectiveness factors:

All units within the Hanford Sub-area have the same effectiveness factor.

For most helpful procurement information please read procedure 2210Z Effectiveness Factors under 7110 (T-138Z) posted at: <http://www.caiso.com/Documents/2210Z.pdf>

3.5.6.2.6 Alternatives to Reduce or Eliminate Gas Generation

As a part of the 2018-2019 transmission planning process the ISO undertook an assessment in approximately half of the LCR areas and LCR Sub-areas to determine potential transmission alternatives to reduce or eliminate the need for gas-fired generation to meet the LCR requirement. Alternatives in the Hanford Sub-area were assessed. The following alternatives were considered.

- Reconductor McCall-Kingsburg #1 line
- Reconductor Mccall-Kingsburg #1 and #2 line

Table 3.5-49 provides the LCR requirement for the alternatives identified above. For the alternatives that reduced the LCR requirement but did not eliminate the requirement, the limiting facility and contingency have been provided.

Table 3.5-49 Alternatives to Reduce or Eliminate the Hanford Sub-Area Requirement for Gas-fired generation

Year	Limit	Category	Limiting Facility	Contingency	LCR (MW) (Deficiency)
Reconductor McCall-Kingsburg #1 line					
2028	First Limit	C	McCall-Kingsburg #2 115 kV	McCall-Kingsburg #1 115 kV & Henrietta #3 230/115 kV Tx	86
Reconductor Mccall-Kingsburg #1 and #2 line					
2028	First limit	C	None	None	0

Table 3.5-50 provides the cost estimates and the total Hanford LCR Sub-area requirement and portion of requirement that would need to be supplied from gas-fired and non gas generation for the alternatives identified above

Table 3.5-50 Alternative Cost Estimate and LCR Requirement

Alternatives	Submitted By	Estimated Cost (\$M)	Requirement (MW)			
			Total	Market Gas	Other Gas	Non-Gas
Reconductor McCall-Kingsburg #1 115 kV line	CAISO	\$9M	86	51	35	0
Reconductor McCall-Kingsburg #1 and #2 115 kV lines	CAISO	\$23.5M	0	0	0	0

Two alternatives were assessed to reduce the LCR requirement in the Hanford Sub-area.

- The reconductoring of the McCall-Kingsburg #1 115 kV line reduced the Hanford Sub-area requirement by 39 MW from 125 MW to 86 MW.
- The reconductoring of both the McCall-Kingsburg #1 and #2 115 kV lines eliminates the requirement in Hanford Sub-area.

The economic assessment of the reduction and elimination of the gas-fired generation to address the Hanford LCR Sub-area requirement of both of the alternatives above is in section 1.9.5 in Chapter 4.

3.5.6.3 Coalinga Sub-area

Coalinga is a Sub-area of the Fresno LCR Area.

3.5.6.3.1 Coalinga LCR Sub-area Diagram

Figure 3.5-52 Coalinga LCR Sub-area

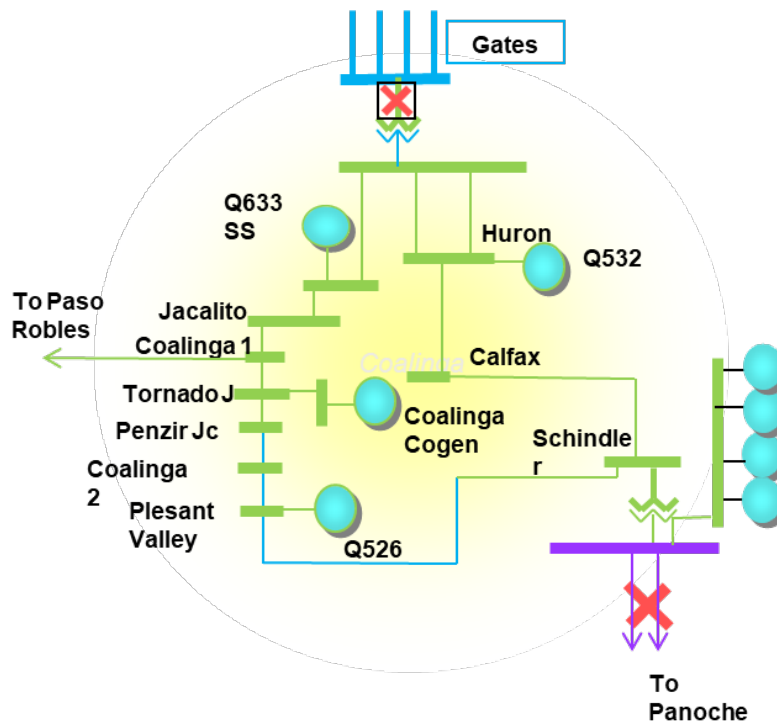

3.5.6.3.2 Coalinga LCR Sub-area Load and Resources

Table 3.5-51 provides the forecast load and resources in Coalinga LCR Sub-area in 2028. The list of generators within the LCR Sub-area are provided in Attachment A.

Table 3.5-51 Coalinga LCR Sub-area 2028 Forecast Load and Resources

Load (MW)		Generation (MW)	
Gross Load	91	Market Gas	35
AAEE	-7	Other Gas	3
Behind the meter DG	0	Non-Gas	8
Net Load	84		
Transmission Losses	1		
Pumps	0	Total Qualifying Capacity	45
Load + Losses + Pumps	85		

3.5.6.3.3 Coalinga LCR Sub-area Hourly Profiles

Figure 3.5-53 illustrates the forecast 2028 profile for the summer peak, winter peak and spring off-peak days for the Coalinga LCR Sub-area with the Category C (Multiple Contingency) transmission capability with no market gas. Figure 3.5-54 illustrates the forecast 2028 hourly profile for Coalinga LCR Sub-area with the Category C (Multiple Contingency) transmission capability with no market gas. The red dotted line in the figures represents the transmission capability with no market gas and the solar output in the area output of zero MW.

Figure 3.5-53 Coalinga LCR Sub-area 2028 Peak Day Forecast Profiles

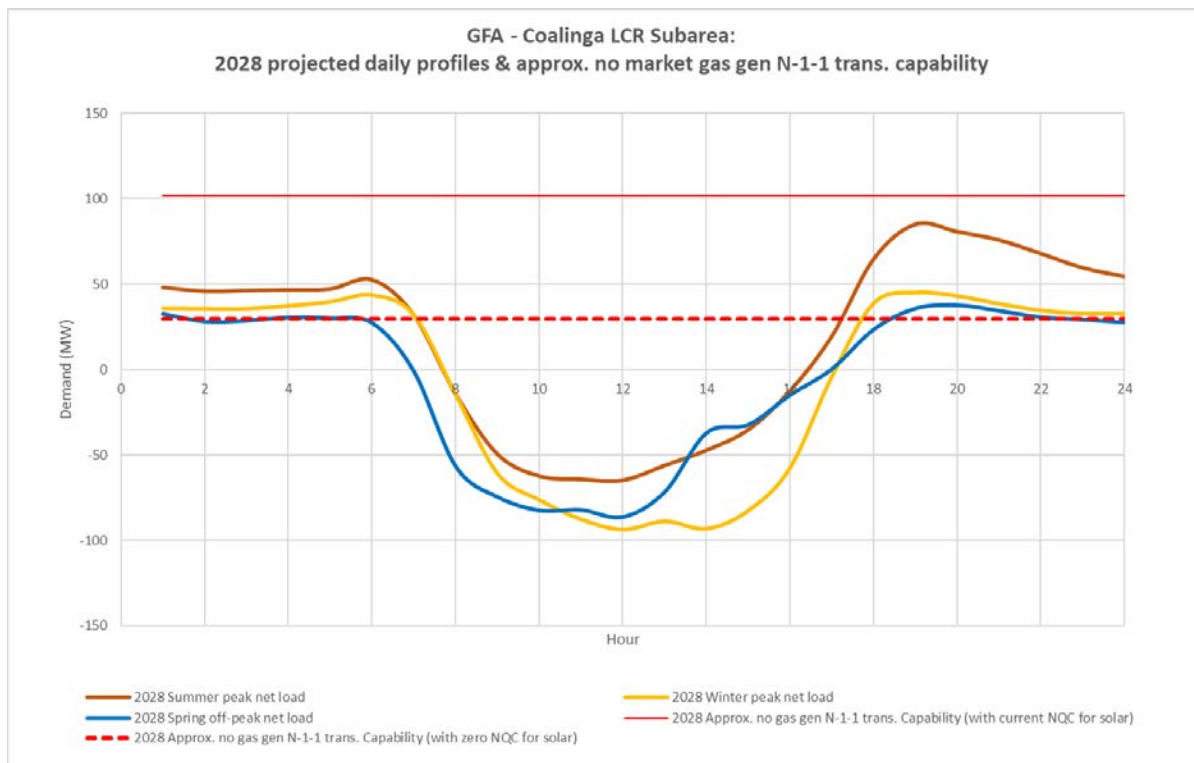
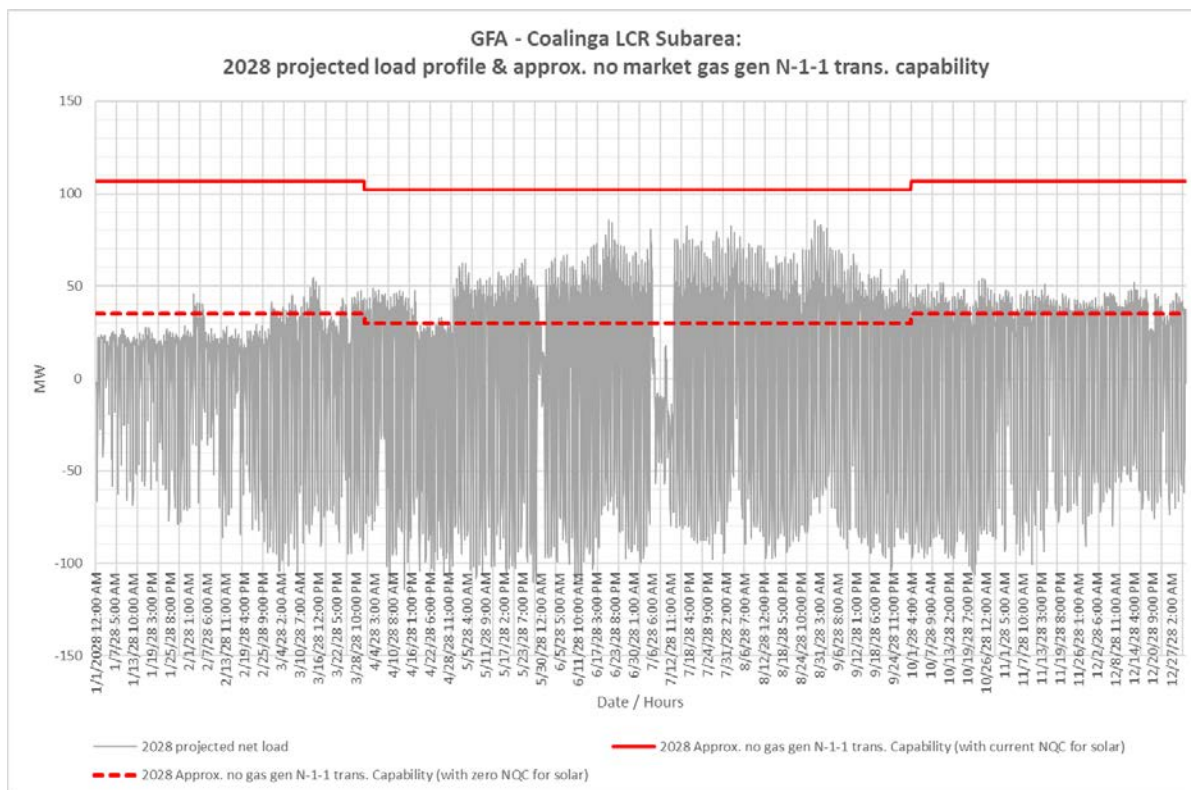

Figure 3.5-54 Coalinga LCR Sub-area 2028 Forecast Hourly Profiles



3.5.6.3.4 Coalinga LCR Sub-area Requirement

Table 3.5-52 identifies the Coalinga 2028 LCR Sub-area requirements. There was no LCR requirement for Category B (Single Contingency) and the LCR Requirement for a Category C (Multiple Contingency) is 17 MW. The second and third limiting facility and contingency has been provided for information only.

Table 3.5-52 Coalinga LCR Sub-area Requirements

Year	Limit	Category	Limiting Facility	Contingency	LCR (MW) (Deficiency)
2028	First Limit	B	None	None	0
2028	First Limit	C	Voltage Instability	Gates #5 230/70 kV Tx followed by Panoche-Schindler #1 & #2 115 kV DCTL	17

3.5.6.3.5 Effectiveness factors:

All units within the Coalinga Sub-area have the same effectiveness factor.

For most helpful procurement information please read procedure 2210Z Effectiveness Factors under 7110 (T-138Z) posted at: <http://www.aiso.com/Documents/2210Z.pdf>

3.5.6.3.6 Alternatives to Reduce or Eliminate Gas Generation

As a part of the 2018-2019 transmission planning process the ISO undertook an assessment in approximately half of the LCR areas and LCR Sub-areas to determine potential transmission alternatives to reduce or eliminate the need for gas-fired generation to meet the LCR requirement. In the 2018-2019 transmission planning process the Coalinga LCR Sub-area was not selected to assess alternatives to reduce or eliminate the requirement for gas-fired generation to address the LCR requirement.

3.5.6.4 **Borden Sub-area**

Borden is a Sub-area of the Fresno LCR Area.

3.5.6.4.1 **Borden LCR Sub-area Diagram**

Figure 3.5-55 Borden LCR Sub-area

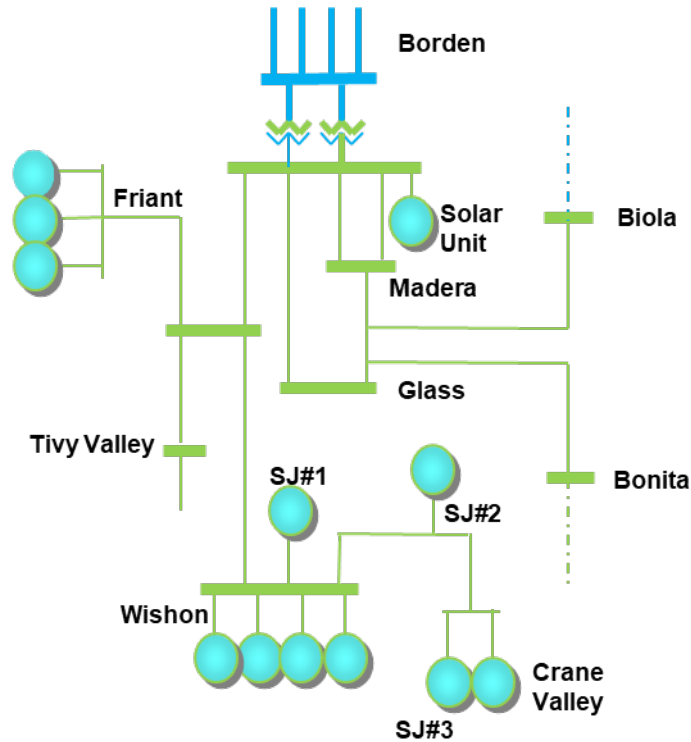

3.5.6.4.2 **Borden LCR Sub-area Load and Resources**

Table 3.5-53 provides the forecast load and resources in Borden LCR Sub-area in 2028. The list of generators within the LCR Sub-area are provided in Attachment A.

Table 3.5-53 Borden LCR Sub-area 2028 Forecast Load and Resources

Load (MW)		Generation (MW)	
Gross Load	160	Market Gas	0
AAEE	-11	Other Gas	0
Behind the meter DG	0	Non-Gas	57
Net Load	149		
Transmission Losses	3		
Pumps	0	Total Qualifying Capacity	57
Load + Losses + Pumps	152		

3.5.6.4.3 Borden LCR Sub-area Hourly Profiles

Figure 3.5-56 illustrates the forecast 2028 profile for the summer peak, winter peak and spring off-peak days for the Borden LCR Sub-area with the Category C (Multiple Contingency) transmission capability with no market gas. Figure 3.5-57 illustrates the forecast 2028 hourly profile for Borden LCR Sub-area with the Category C (Multiple Contingency) transmission capability with no market gas. The red dotted line in the figures represents the transmission capability with no market gas and the solar output in the area output of zero MW.

Figure 3.5-56 Borden LCR Sub-area 2028 Peak Day Forecast Profiles

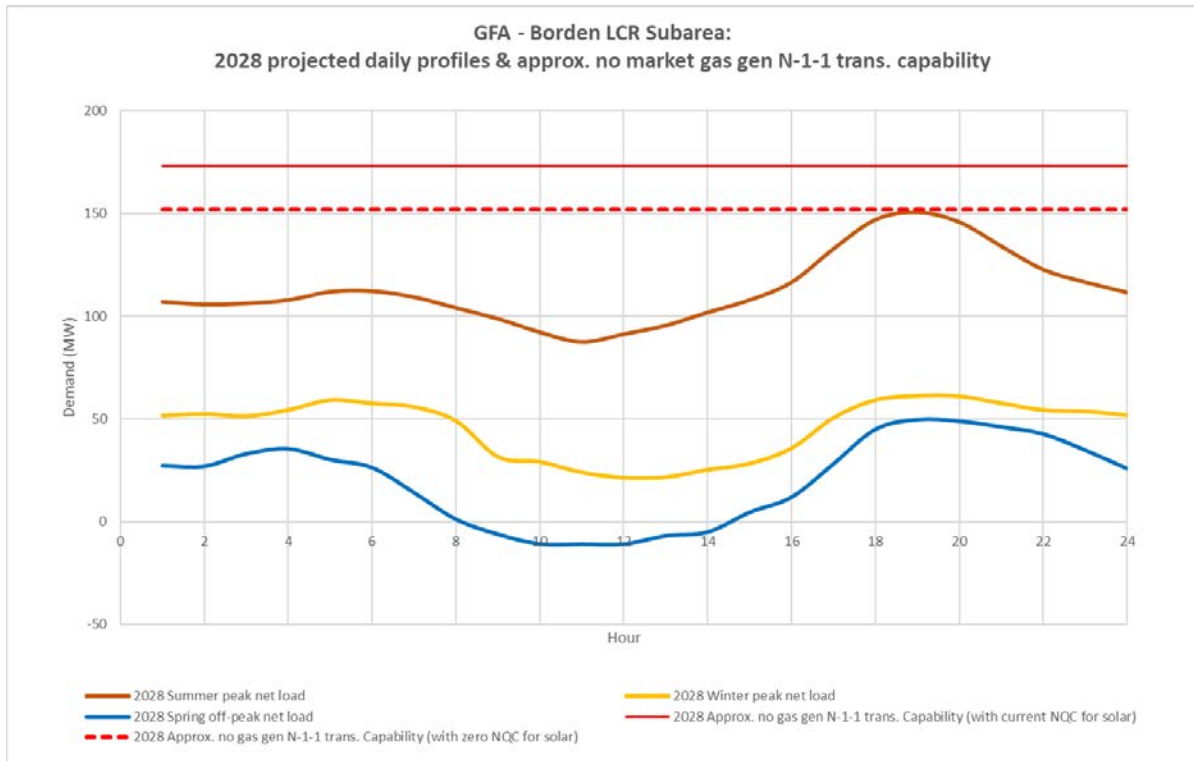
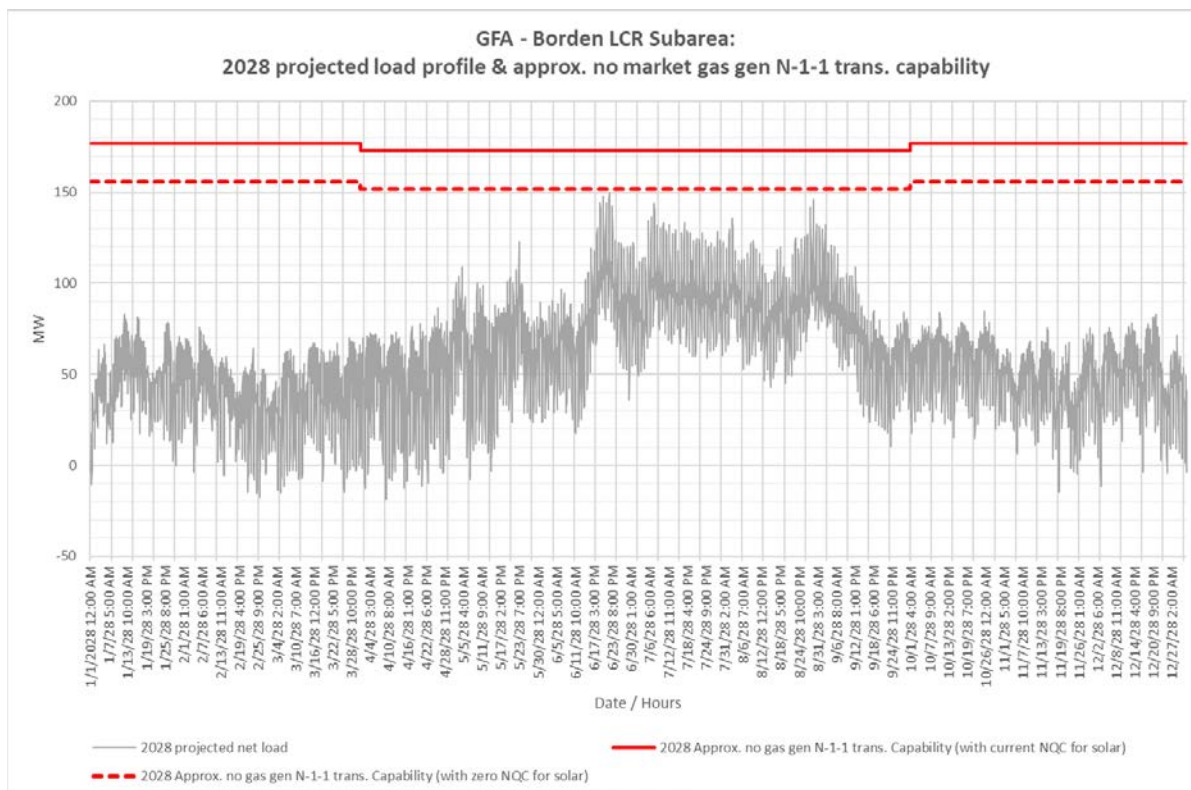

Figure 3.5-57 Borden LCR Sub-area 2028 Forecast Hourly Profiles



3.5.6.4.4 Borden LCR Sub-area Requirement

Table 3.5-54 identifies the Borden 2028 LCR Sub-area requirements. The LCR requirement for Category B (Single Contingency) is 21 MW deficiency and for Category C (Multiple Contingency) is 25 MW.

Table 3.5-54 Borden LCR Sub-area Requirements

Year	Limit	Category	Limiting Facility	Contingency	LCR (MW) (Deficiency)
2028	First Limit	B	Borden #1 230/70 kV Tx	Borden 230/70 kV # 4	21
2028	First Limit	C	Borden #1 230/70 kV Tx	Friant - Coppermine 70 kV & Borden #2 230/70 kV Tx	25

3.5.6.4.5 Effectiveness factors:

All units within the Borden Sub-area have the same effectiveness factor.

For most helpful procurement information please read procedure 2210Z Effectiveness Factors under 7110 (T-138Z) posted at: <http://www.caiso.com/Documents/2210Z.pdf>

3.5.6.4.6 Alternatives to Reduce or Eliminate Gas Generation

As a part of the 2018-2019 transmission planning process the ISO undertook an assessment in approximately half of the LCR areas and LCR Sub-areas to determine potential transmission alternatives to reduce or eliminate the need for gas-fired generation to meet the LCR requirement. In the 2018-2019 transmission planning process the Borden LCR Sub-area was not selected to assess alternatives to reduce or eliminate the requirement for gas-fired generation to address the LCR requirement. The 2028 LCT study identified that the requirement in the Borden Sub-area can be addressed with nongas-fired generation.

3.5.6.5 Reedley Sub-area

Reedley is a Sub-area of the Fresno LCR Area.

3.5.6.5.1 Reedley LCR Sub-area Diagram

Figure 3.5-58 Reedley LCR Sub-area

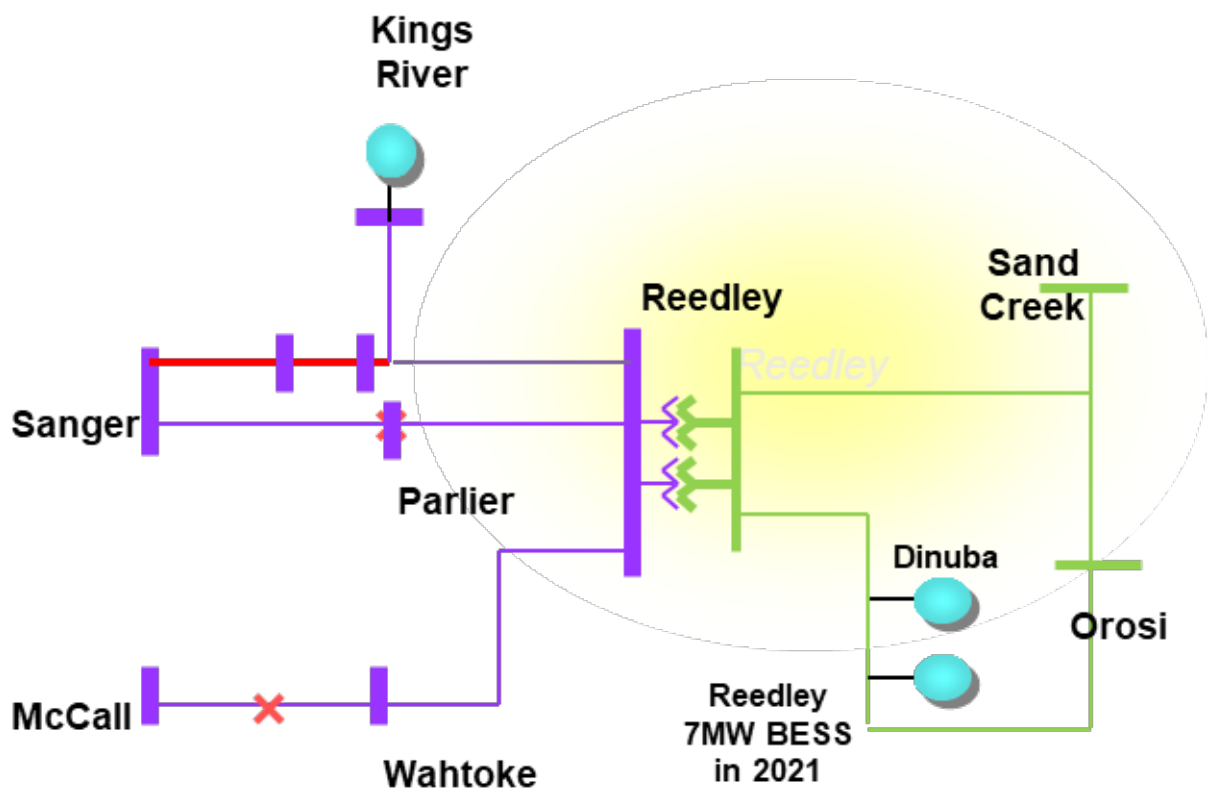

3.5.6.5.2 Reedley LCR Sub-area Load and Resources

Table 3.5-55 provides the forecast load and resources in Coalinga LCR Sub-area in 2028. The list of generators within the LCR Sub-area are provided in Attachment A.

Table 3.5-55 Reedley LCR Sub-area 2028 Forecast Load and Resources

Load (MW)		Generation (MW)	
Gross Load	244	Market Gas	48
AAEE	-14	Other Gas	0
Behind the meter DG	0	Non-Gas	88
Net Load	230		
Transmission Losses	35		
Pumps	0	Total Qualifying Capacity	136
Load + Losses + Pumps	265		

3.5.6.5.3 Reedley LCR Sub-area Hourly Profiles

Figure 3.5-59 illustrates the forecast 2028 profile for the summer peak, winter peak and spring off-peak days for the Reedley LCR Sub-area with the Category C (Multiple Contingency) transmission capability with no market gas. Figure 3.5-60 illustrates the forecast 2028 hourly profile for Reedley LCR Sub-area with the Category C (Multiple Contingency) transmission capability with no market gas. The red dotted line in the figures represents the transmission capability with no market gas and the solar output in the area output of zero MW.

Figure 3.5-59 Reedley LCR Sub-area 2028 Peak Day Forecast Profiles

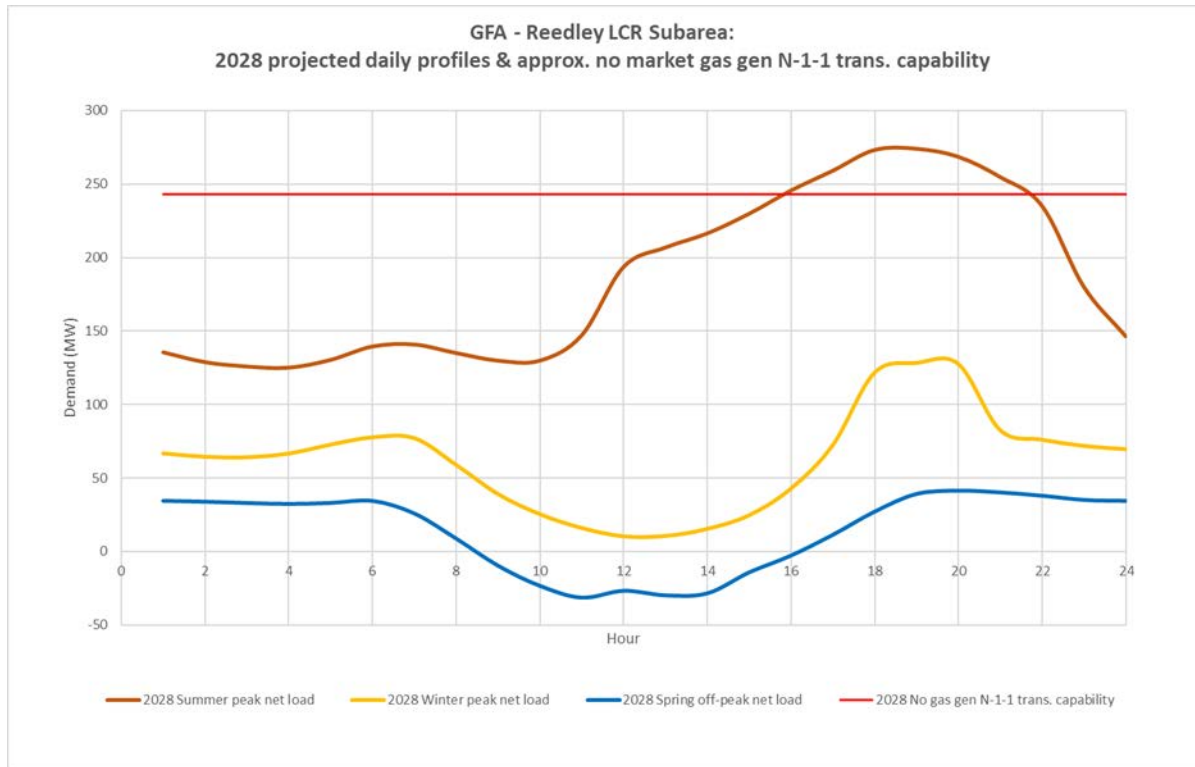
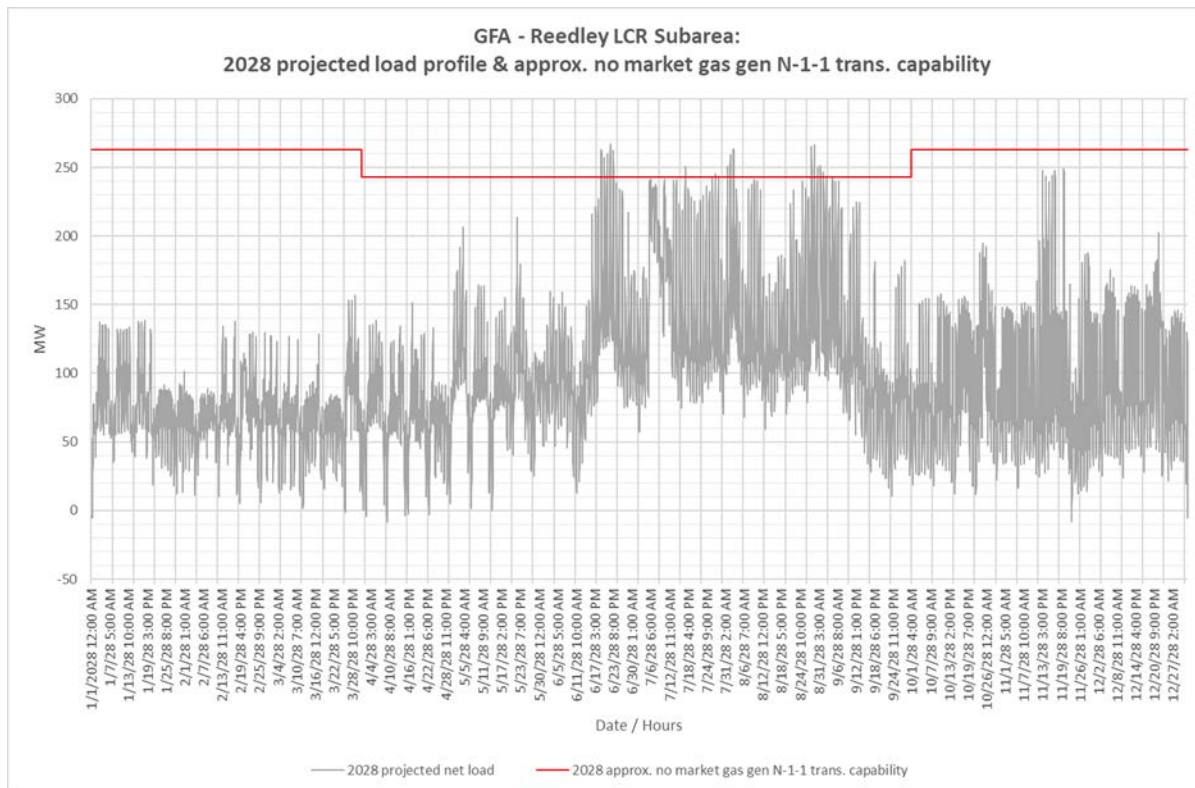

Figure 3.5-60 Reedley LCR Sub-area 2028 Forecast Hourly Profiles



3.5.6.5.4 Reedley LCR Sub-area Requirement

Table 3.5-56 identifies the Reedley 2028 LCR Sub-area requirements. There was no LCR requirement for Category B (Single Contingency) and the LCR Requirement for a Category C (Multiple Contingency) is 39 MW.

Table 3.5-56 Reedley LCR Sub-area Requirements

Year	Limit	Category	Limiting Facility	Contingency	LCR (MW) (Deficiency)
2028	First Limit	B	None	None	0
2028	First Limit	C	Kings River-Sanger-Reedley 115 kV	McCall-Reedley 115 kV & Sanger-Reedley 115 kV	39

3.5.6.5.5 Effectiveness factors:

All units within the Reedley Sub-area have the same effectiveness factor.

For most helpful procurement information please read procedure 2210Z Effectiveness Factors under 7110 (T-138Z) posted at: <http://www.caiso.com/Documents/2210Z.pdf>

3.5.6.5.6 Alternatives to Reduce or Eliminate Gas Generation

As a part of the 2018-2019 transmission planning process the ISO undertook an assessment in approximately half of the LCR areas and LCR Sub-areas to determine potential transmission alternatives to reduce or eliminate the need for gas-fired generation to meet the LCR requirement. Alternatives in the Reedley Sub-area were assessed. The following alternatives were considered.

- Increase Dinuba Battery to 40 MW
- New McCall-Reedley #2 115 kV line
- Reconductor Kings River-Sanger-Reedley 115 kV Line (From Sanger-Piedra)
- Reconductor Kings River-Sanger-Reedley 115 kV Line (Full Line)

Table 3.5-57 provides the LCR requirement for the alternatives identified above. For the alternatives that reduced the LCR requirement but did not eliminate the requirement, the limiting facility and contingency have been provided.

Table 3.5-57 Alternatives to Reduce or Eliminate the Reedley Sub-Area Requirement for Gas-fired generation

Year	Limit	Category	Limiting Facility	Contingency	LCR (MW) (Deficiency)
Increase Dinuba Battery to 40 MW					
2028	First limit	C	None	None	0
New McCall-Reedley #2 115 kV line					
2028	First limit	C	None	None	0
Reconductor Kings River-Sanger-Reedley 115 kV Line (From Sanger-Piedra)					
2028	First limit	C	Kings River-Sanger-Reedley 115kV line(Piedra to Reedley)	McCall-Reedley 115kV Line & Sanger-Reedley 115kV line	19
Reconductor Kings River-Sanger-Reedley 115 kV Line (Full Line)					
2028	First limit	C	None	None	0

Table 3.5-58 provides the cost estimates and the total Reedley LCR Sub-area requirement and portion of requirement that would need to be supplied from gas-fired and non gas generation for the alternatives identified above

Table 3.5-58 Alternative Cost Estimate and LCR Requirement

Alternatives	Submitted By	Estimated Cost (\$M)	Requirement (MW)			
			Total	Market Gas	Other Gas	Non-Gas
Dinuba Battery MW Increase to 40 MW	CAISO	TBD	0	0	0	0
Reconductor Kings River-Sanger-Reedley 115 kv Line (From Sanger-Piedra)	CAISO	\$9M	19	0	0	19
Reconductor Kings River-Sanger-Reedley 115 kv Line (Full Line)	CAISO	\$9M+TBD	0	0	0	0
New McCall-Reedley #2 115 kV line	PGE	\$30-\$40M	0	0	0	0

Alternatives in the Reedley area were assessed to determine what it would take to eliminate the LCR requirement for the sub-area. The 2028 LCT study identified that the requirement in the Reedley Sub-area can be addressed with nongas-fired generation.

3.5.6.6 **Herndon Sub-area**

Herndon is a Sub-area of the Fresno LCR Area.

3.5.6.6.1 **Herndon LCR Sub-area Diagram**

Figure 3.5-61 Herndon LCR Sub-area

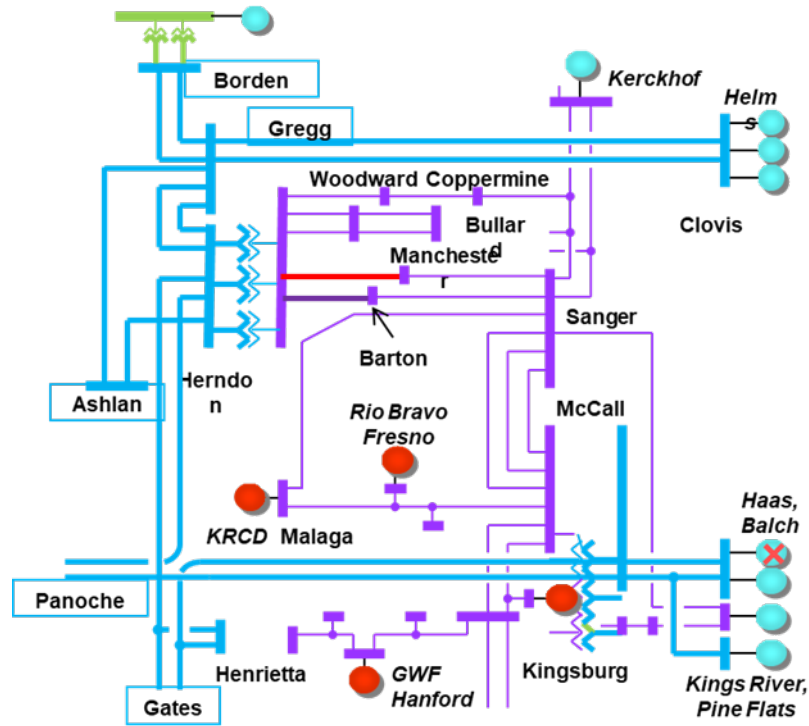

3.5.6.6.2 **Herndon LCR Sub-area Load and Resources**

Table 3.5-59 provides the forecast load and resources in Herndon LCR Sub-area in 2028. The list of generators within the LCR Sub-area are provided in Attachment A.

Table 3.5-59 Herndon LCR Sub-area 2028 Forecast Load and Resources

Load (MW)		Generation (MW)	
Gross Load	1763	Market Gas	350
AAEE	-102	Other Gas	0
Behind the meter DG	-3	Non-Gas	889
Net Load	1658		
Transmission Losses	30		
Pumps	0	Total Qualifying Capacity	1239
Load + Losses + Pumps	1688		

3.5.6.6.3 Herndon LCR Sub-area Hourly Profiles

Figure 3.5-62 illustrates the forecast 2028 profile for the summer peak, winter peak and spring off-peak days for the Herndon LCR Sub-area with the Category C (Multiple Contingency) transmission capability with no market gas. Figure 3.5-63 illustrates the forecast 2028 hourly profile for Herndon LCR Sub-area with the Category C (Multiple Contingency) transmission capability with no market gas. The red dotted line in the figures represents the transmission capability with no market gas and the solar output in the area output of zero MW. With redispatch of resources in the area after the first contingency the flow would be below the transmission capability in the figures.

Figure 3.5-62 Herndon LCR Sub-area 2028 Peak Day Forecast Profiles

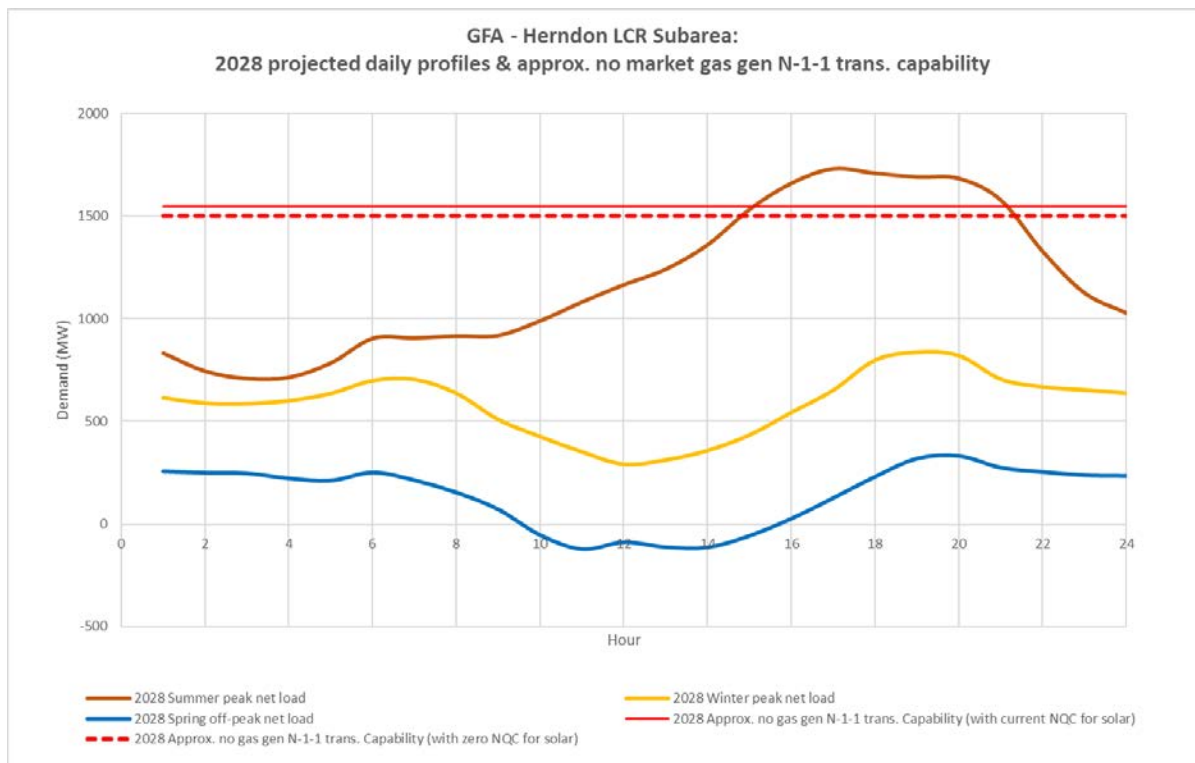
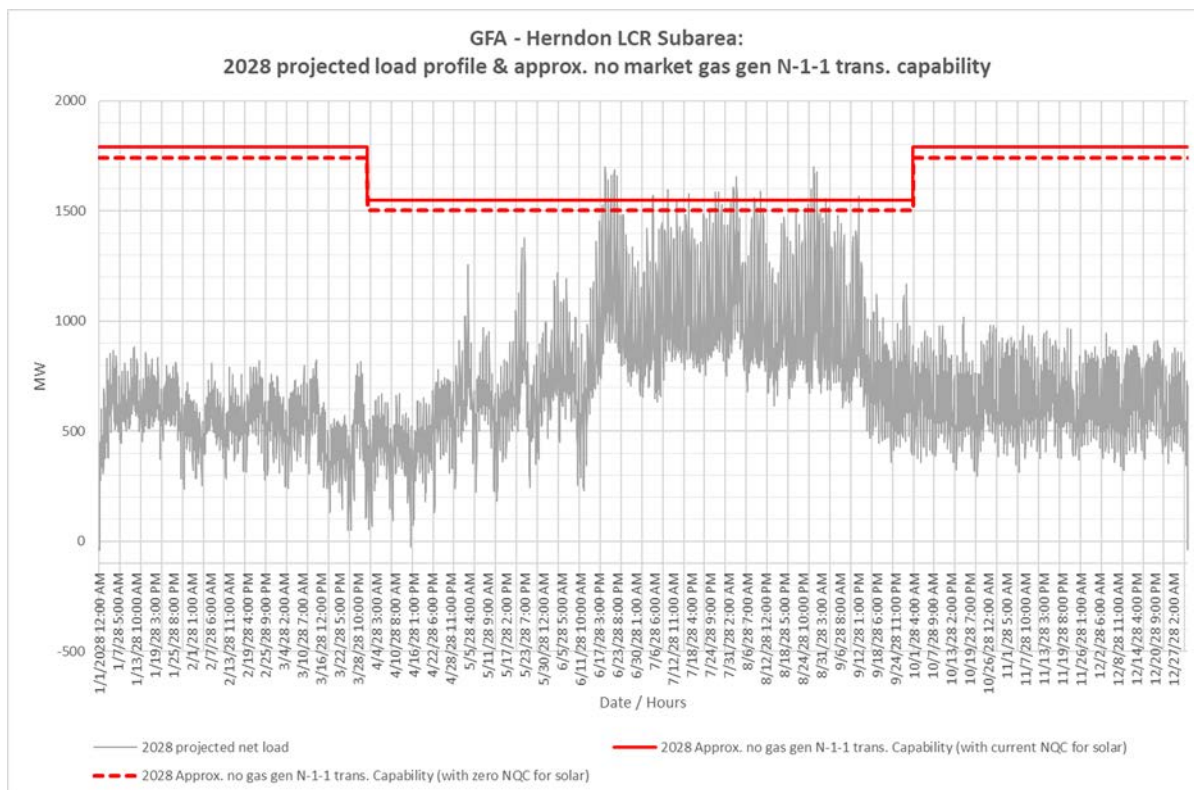

Figure 3.5-63 Herndon LCR Sub-area 2028 Forecast Hourly Profiles



3.5.6.6.4 Herndon LCR Sub-area Requirement

Table 3.5-60 identifies the Herndon 2028 LCR Sub-area requirements. There LCR requirement for Category B (Single Contingency) is 326 MW and the LCR Requirement for a Category C (Multiple Contingency) is 752 MW.

Table 3.5-60 Herndon LCR Sub-area Requirements

Year	Limit	Category	Limiting Facility	Contingency	LCR (MW) (Deficiency)
2028	First limit	B	Herndon-Manchester 115 kV	Balch Unit 1 & Herndon-Barton 115 kV	326
2028	First limit	C	Herndon-Manchester 115 kV	Herndon-Woodward 115 kV line, system readjustment & Herndon- Barton 115 kV line	752

3.5.6.6.5 Effectiveness factors:

Effectiveness factors for generators in the Herndon LCR Sub-area are in Attachment B table titled Herndon.

For other helpful procurement information please read procedure 2210Z Effectiveness Factors under 7230 (T-165Z) posted at: <http://www.caiso.com/Documents/2210Z.pdf>

3.5.6.6.6 Alternatives to Reduce or Eliminate Gas Generation

As a part of the 2018-2019 transmission planning process the ISO undertook an assessment in approximately half of the LCR areas and LCR Sub-areas to determine potential transmission alternatives to reduce or eliminate the need for gas-fired generation to meet the LCR requirement. In the 2018-2019 transmission planning process the Herndon LCR Sub-area was selected to assess alternatives to reduce or eliminate the requirement for gas-fired generation to address the LCR requirement; however the 2028 LCR assessment indicates that the Herndon LCR Sub-area requirement can be addressed by nongas fired generation in the Sub-area.

3.5.6.7 Wilson Sub-area (Fresno Area Overall)

Wilson is a Sub-area of the Fresno LCR Area.

3.5.6.7.1 Wilson LCR Sub-area Diagram

Figure 3.5-64 Wilson LCR Sub-area

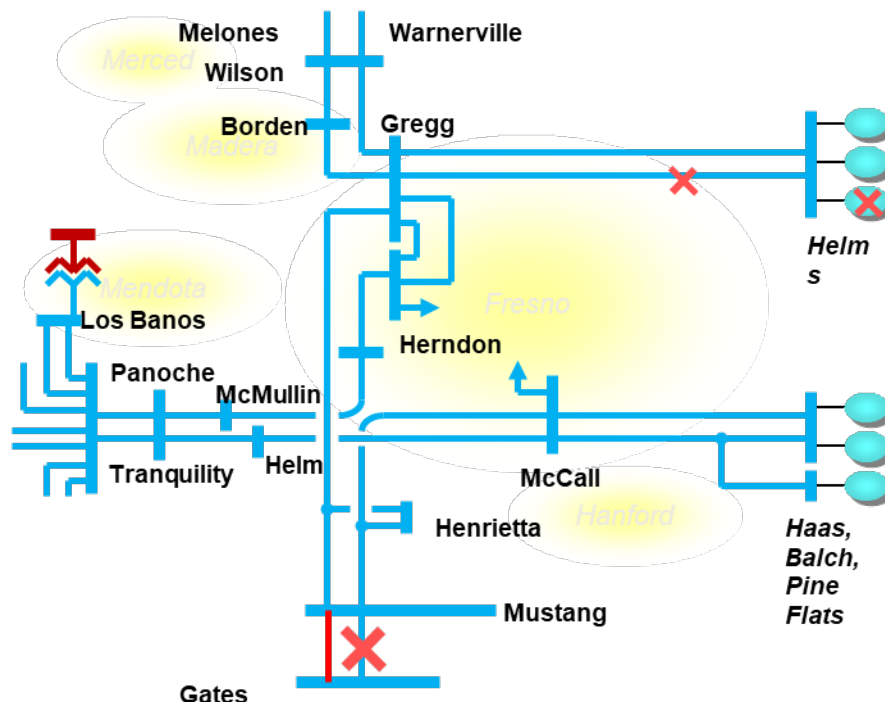

3.5.6.7.2 Wilson LCR Sub-area Load and Resources

Table 3.5-61 provides the forecast load and resources in Wilson LCR Sub-area in 2028. The list of generators within the LCR Sub-area are provided in Attachment A.

Table 3.5-61 Wilson LCR Sub-area 2028 Forecast Load and Resources

Load (MW)		Generation (MW)	
Gross Load	3617	Market Gas	750
AEE	-227	Other Gas	3
Behind the meter DG	-3	Non-Gas	2755
Net Load	3387		
Transmission Losses	109		
Pumps	0	Total Qualifying Capacity	3508
Load + Losses + Pumps	3496		

3.5.6.7.3 Wilson LCR Sub-area Hourly Profiles

Figure 3.5-65 illustrates the forecast 2028 profile for the summer peak, winter peak and spring off-peak days for the Wilson LCR Sub-area with the Category C (Multiple Contingency) transmission capability with no market gas. Figure 3.5-66 illustrates the forecast 2028 hourly profile for Wilson LCR Sub-area with the Category C (Multiple Contingency) transmission capability with no market gas. The red dotted line in the figures represents the transmission capability with no market gas and the solar output in the area output of zero MW.

Figure 3.5-65 Wilson LCR Sub-area 2028 Peak Day Forecast Profiles

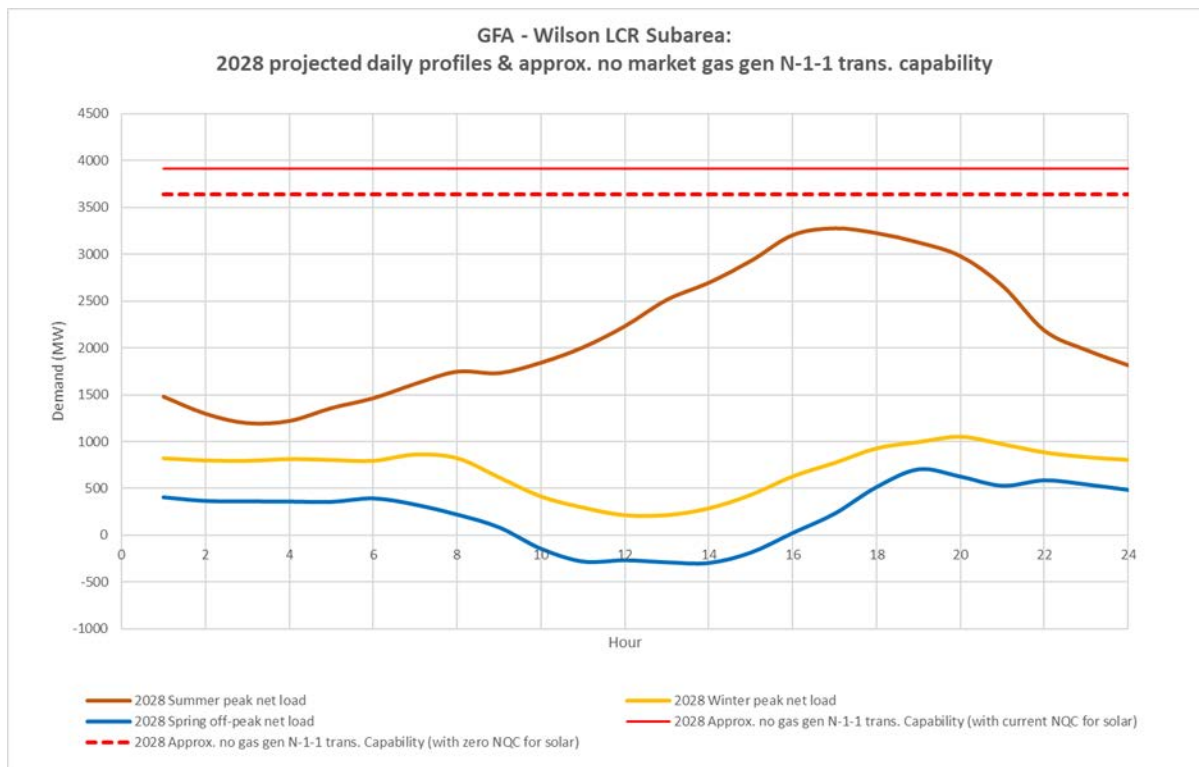
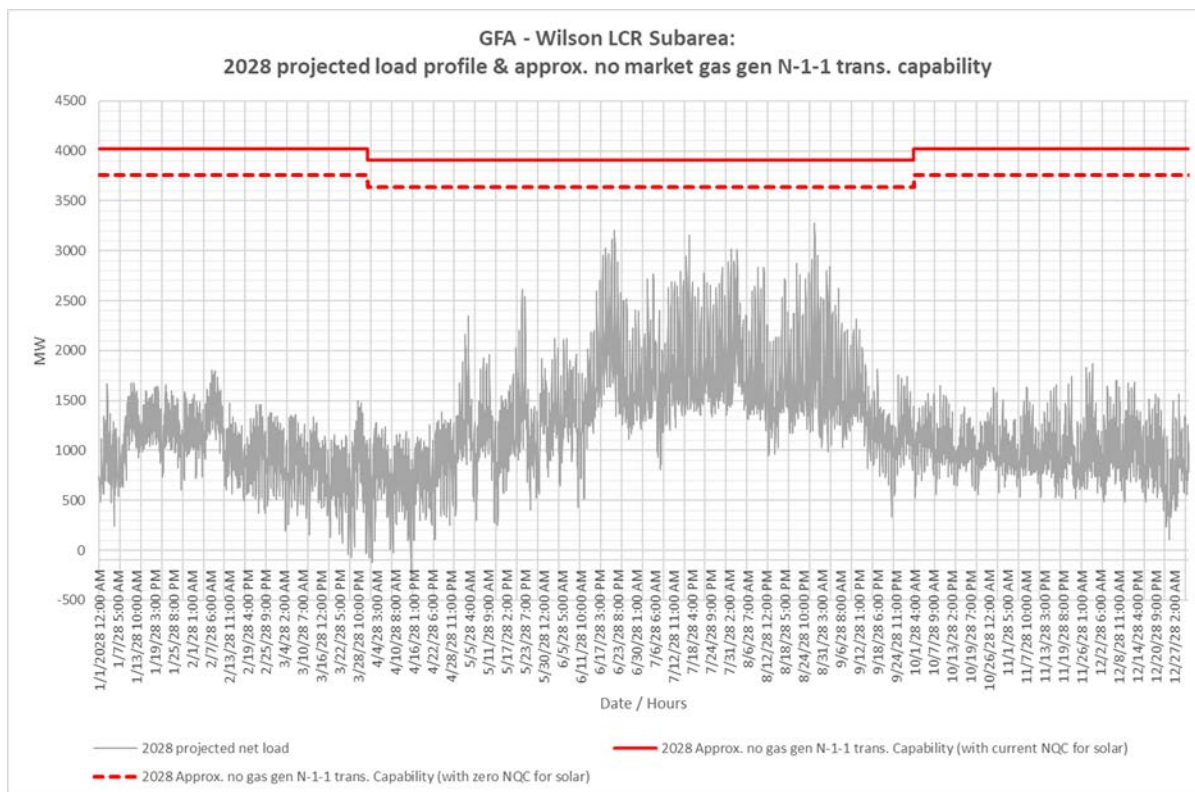

Figure 3.5-66 Wilson LCR Sub-area 2028 Forecast Hourly Profiles



3.5.6.7.4 Wilson LCR Sub-area Requirement

Table 3.5-62 identifies the Wilson 2028 LCR Sub-area requirements. The LCR requirement for Category B (Single Contingency) is 1628 MW and the LCR Requirement for a Category C (Multiple Contingency) is 1728 MW.

Table 3.5-62 Wilson LCR Sub-area Requirements

Year	Limit	Category	Limiting Facility	Contingency	LCR (MW) (Deficiency)
2028	First limit	B	Remaining Gates-Mustang 230 kV	Gates-Mustang 230kV #1 or #2 and one Helms unit out	1628
2028	First limit	C	Remaining Gates-Mustang 230 kV	Gates-Mustang 230 kV #1 or #2 and Helms-Gregg 230 kV	1728

3.5.6.7.5 Effectiveness factors:

All units within the Wilson Sub-area have the same effectiveness factor.

For most helpful procurement information please read procedure 2210Z Effectiveness Factors under 7110 (T-138Z) posted at: <http://www.caiso.com/Documents/2210Z.pdf>

3.5.6.7.6 Changes compared to 2023 requirements

Compared with 2023 the load forecast increased by 265 MW. The LCR need has increased by 40 MW due to a combination of load increase, and new transmission projects.

3.5.6.7.7 Alternatives to Reduce or Eliminate Gas Generation

As a part of the 2018-2019 transmission planning process the ISO undertook an assessment in approximately half of the LCR areas and LCR Sub-areas to determine potential transmission alternatives to reduce or eliminate the need for gas-fired generation to meet the LCR requirement. In the 2018-2019 transmission planning process the Wilson LCR Sub-area was not selected to assess alternatives to reduce or eliminate the requirement for gas-fired generation to address the LCR requirement. The 2028 LCT study identified that the requirement in the Wilson Sub-area can be addressed with nongas-fired generation.

3.5.7 Kern Area

3.5.7.1 *Area Definition:*

The transmission facilities coming into the Kern PP sub-area are:

- Midway-Kern PP #1 230 kV Line
- Midway-Kern PP #2 230 kV Line
- Midway-Kern PP #3 230 kV Line
- Midway-Kern PP #4 230 kV Line
- Wind Gap-Wheeler Ridge #1 230 kV Line
- Wind Gap-Wheeler Ridge #2 230 kV Line
- Famoso-Lerdo 115 kV Line (Normal Open)
- Wasco-Famoso 70 kV Line (Normal Open)
- Copus-Old River 70 kV Line (Normal Open)
- Copus-Old River 70 kV Line (Normal Open)
- Weedpatch CB 32 70 kV (Normal Open)

The substations that delineate the Kern-PP sub-area are:

- Midway 230 kV is out and Bakerfield 230 kV is in
- Midway 230 kV is out Kern PP 230 kV is in
- Midway 230 kV is out and Stockdale 230 kV is in
- Midway 230 kV is out Kern PP 230 kV is in
- Wind Gap 230 kV is out Wheeler Ridge 230 kV is in
- Wind Gap 230 kV is out Wheeler Ridge 230 kV is in
- Famoso 115 kV is out Cawelo 115 kV is in
- Wasco 70 kV is out Mc Farland 70 kV is in
- Copus 70 kV is out, South Kern Solar 70 kV is in
- Lakeview 70 kV is out, San Emidio Junction 70 kV is in
- Weedpatch 70 kV is out, Wellfield 70 kV is in

3.5.7.1.1 Kern LCR Area Diagram

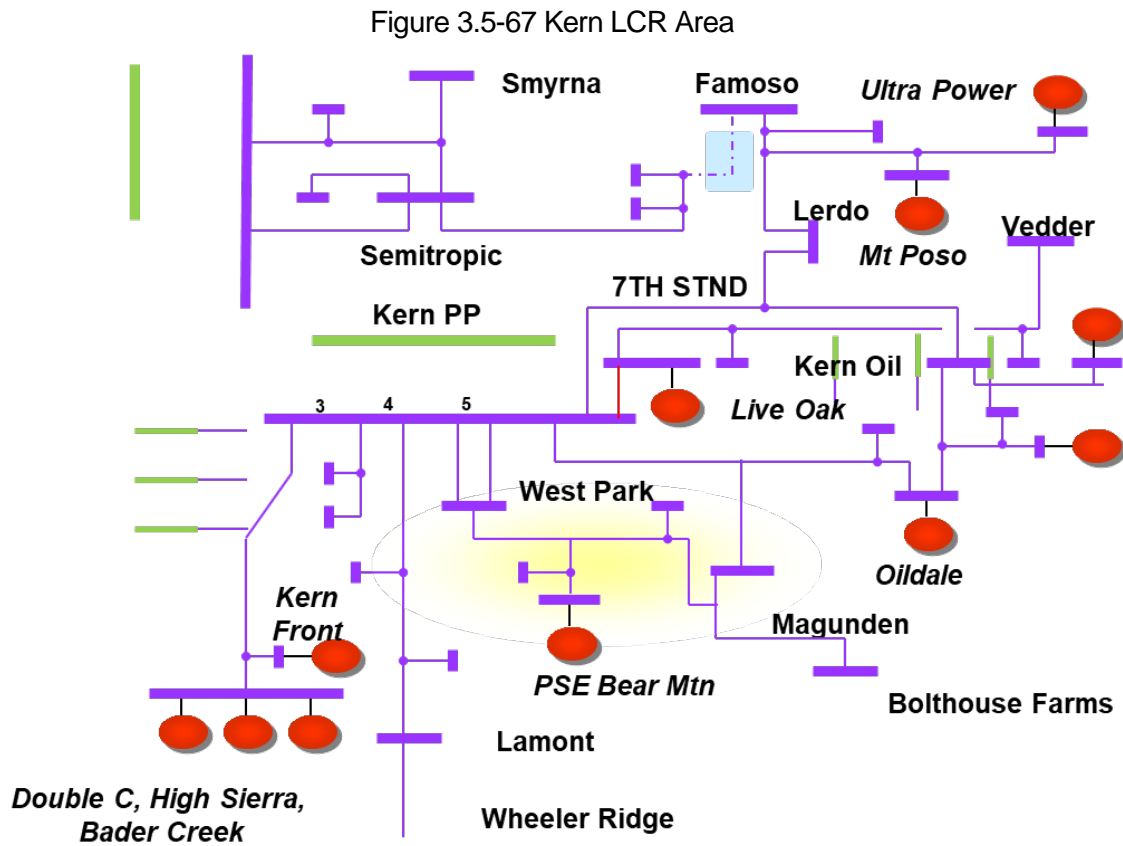

3.5.7.1.2 Kern LCR Area Load and Resources

Table 3.5-63 provides the forecast load and resources in Kern LCR Area in 2028. The list of generators within the LCR Sub-area are provided in Attachment A.

Table 3.5-63 Kern LCR Area 2028 Forecast Load and Resources

Load (MW)		Generation (MW)	
Gross Load	1468	Market Gas	301
AAEE	-88	Other Gas	13
Behind the meter DG	0	Non-Gas	161
Net Load	1380		
Transmission Losses	13	QF	0
Pumps	0	Total Qualifying Capacity	475
Load + Losses + Pumps	1393		

3.5.7.1.3 Approved transmission projects modeled

- Kern PP 230 kV area reinforcement project
- Midway-Kern PP 1, 3 & 4 230 kV line capacity increase project
- Kern PP 115 kV area reinforcement project
- Wheeler Ridge Junction station project

3.5.7.2 Kern PP 70 kV Sub-area

Kern PP 70 kV is a new Sub-area of the Kern LCR Area

3.5.7.2.1 Kern PP 70 kV LCR Sub-area Diagram

Figure 3.5-68 Kern PP 70 kV LCR Sub-area

Figure not available at this time.

3.5.7.2.2 Kern PP 70 kV LCR Sub-area Load and Resources

Table 3.5-64 provides the forecast load and resources in Kern PP 70 kV LCR Sub-area in 2028. The list of generators within the LCR Sub-area are provided in Attachment A.

Table 3.5-64 Kern PP 70 kV LCR Sub-area 2028 Forecast Load and Resources

Load (MW)		Generation (MW)	
Gross Load	161	Market Gas	0
AAEE	-8	Other Gas	0
Behind the meter DG	0	Non-Gas	25
Net Load	153		
Transmission Losses	2		
Pumps	0	Total Qualifying Capacity	25
Load + Losses + Pumps	155		

3.5.7.2.3 Kern PP 70 kV LCR Sub-area Hourly Profiles

Figure 3.5-69 illustrates the forecast 2028 profile for the summer peak, winter peak and spring off-peak days for the Kern PP 70 kV LCR Sub-area with the Category C (Multiple Contingency) transmission capability with no market gas. Figure 3.5-70 illustrates the forecast 2028 hourly profile for Kern PP 70 kV LCR Sub-area with the Category C (Multiple Contingency) transmission capability with no market gas. The red dotted line in the figures represents the transmission capability with no market gas and the solar output in the area output of zero MW.

Figure 3.5-69 Kern PP 70 kV LCR Sub-area 2028 Peak Day Forecast Profiles

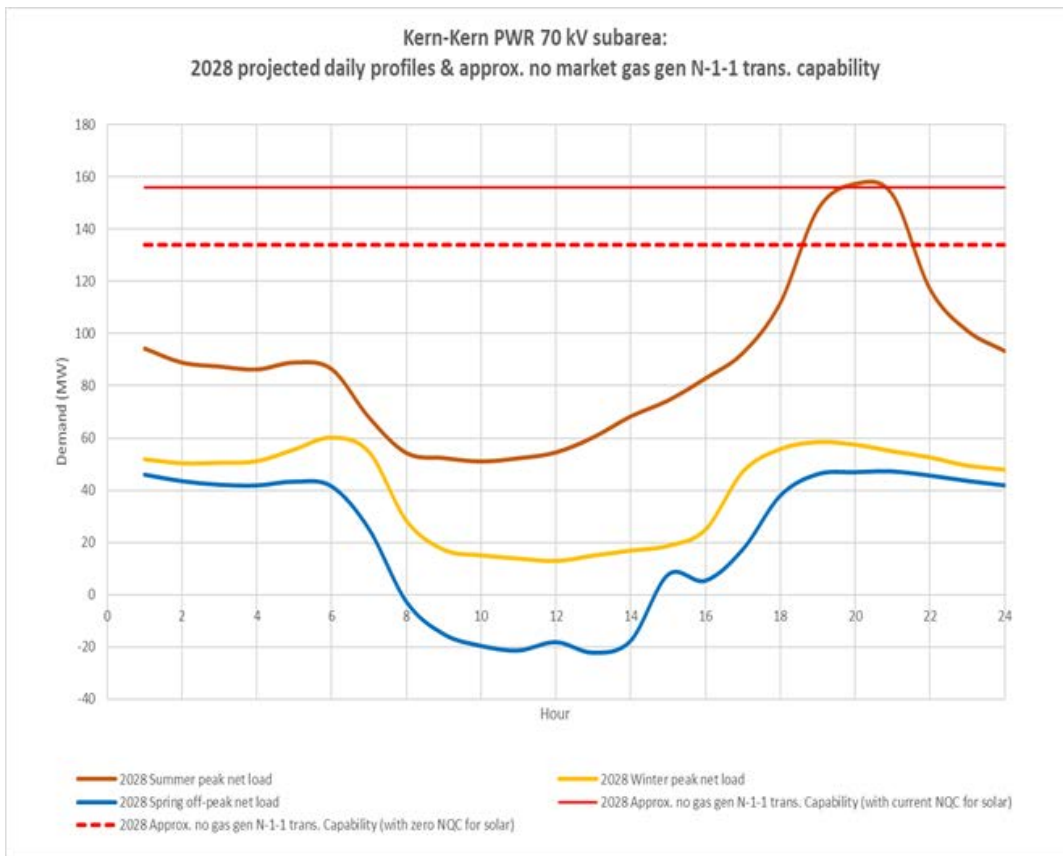
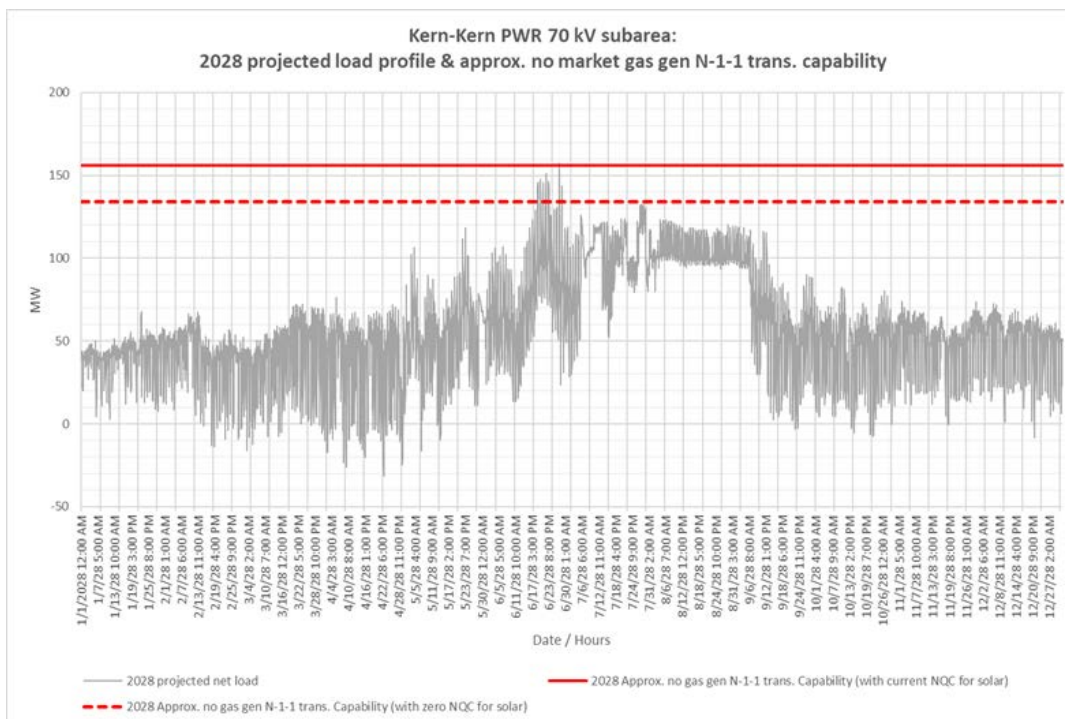

Figure 3.5-70 Kern PP 70 kV LCR Sub-area 2028 Forecast Hourly Profiles



3.5.7.2.4 Kern PP 70 kV LCR Sub-area Requirement

Table 3.5-65 identifies the Kern PP 70 kV 2028 LCR Sub-area requirements. There was no LCR requirement for Category B (Single Contingency) and the LCR Requirement for a Category C (Multiple Contingency) is 31 MW including 3 MW of deficiency.

Table 3.5-65 Kern PP 70 kV LCR Sub-area Requirements

Year	Limit	Category	Limiting Facility	Contingency	LCR (MW) (Deficiency)
2028	First limit	B	None	None	0
2028	First Limit	C	Kern PW2 - Kern PW1 70 kV Bus Tie	Kern PW2 #1 115/70 Tx & Kern-Old River 70 kV	31(3)

3.5.7.2.5 Effectiveness factors:

All units within the Kern PP 70 kV Sub-area have the same effectiveness factor.

For most helpful procurement information please read procedure 2210Z Effectiveness Factors under 7110 (T-138Z) posted at: <http://www.caiso.com/Documents/2210Z.pdf>

3.5.7.2.6 Alternatives to Reduce or Eliminate Gas Generation

As a part of the 2018-2019 transmission planning process the ISO undertook an assessment in approximately half of the LCR areas and LCR Sub-areas to determine potential transmission alternatives to reduce or eliminate the need for gas-fired generation to meet the LCR requirement. The Kern PP 70 kV Sub-area was not identified for assessment as it is a new Sub-area was identified in the 2028 LCT Study. There is no gas-fired generation within the Sub-area. The ISO will continue to monitor the need for this Sub-area. The limiting facility driving the requirement is terminal equipment on the Kern PW2 to Kern PW1 70 kV Bus Tie.

3.5.7.3 Westpark Sub-area

Westpark is a Sub-area of the Kern LCR Area.

3.5.7.3.1 Westpark LCR Sub-area Diagram

Please see Figure 3.5-67 for Westpark Sub-area diagram.

3.5.7.3.2 Westpark LCR Sub-area Load and Resources

Table 3.5-66 provides the forecast load and resources in Westpark LCR Sub-area in 2028. The list of generators within the LCR Sub-area are provided in Attachment A.

Table 3.5-66 Westpark LCR Sub-area 2028 Forecast Load and Resources

Load (MW)		Generation (MW)	
Gross Load	183	Market Gas	45
AAEE	-10	Other Gas	0
Behind the meter DG	0	Non-Gas	0
Net Load	173		
Transmission Losses	0	QF	0
Pumps	0	Total Qualifying Capacity	45
Load + Losses + Pumps	173		

3.5.7.3.3 Westpark LCR Sub-area Hourly Profiles

Figure 3.5-71 illustrates the forecast 2028 profile for the summer peak, winter peak and spring off-peak days for the Westpark LCR Sub-area with the Category C (Multiple Contingency) transmission capability with no market gas. Figure 3.5-72 illustrates the forecast 2028 hourly profile for Westpark LCR Sub-area with the Category C (Multiple Contingency) transmission capability with no market gas. The red dotted line in the figures represents the transmission capability with no market gas and the solar output in the area output of zero MW.

Figure 3.5-71 Westpark LCR Sub-area 2028 Peak Day Forecast Profiles

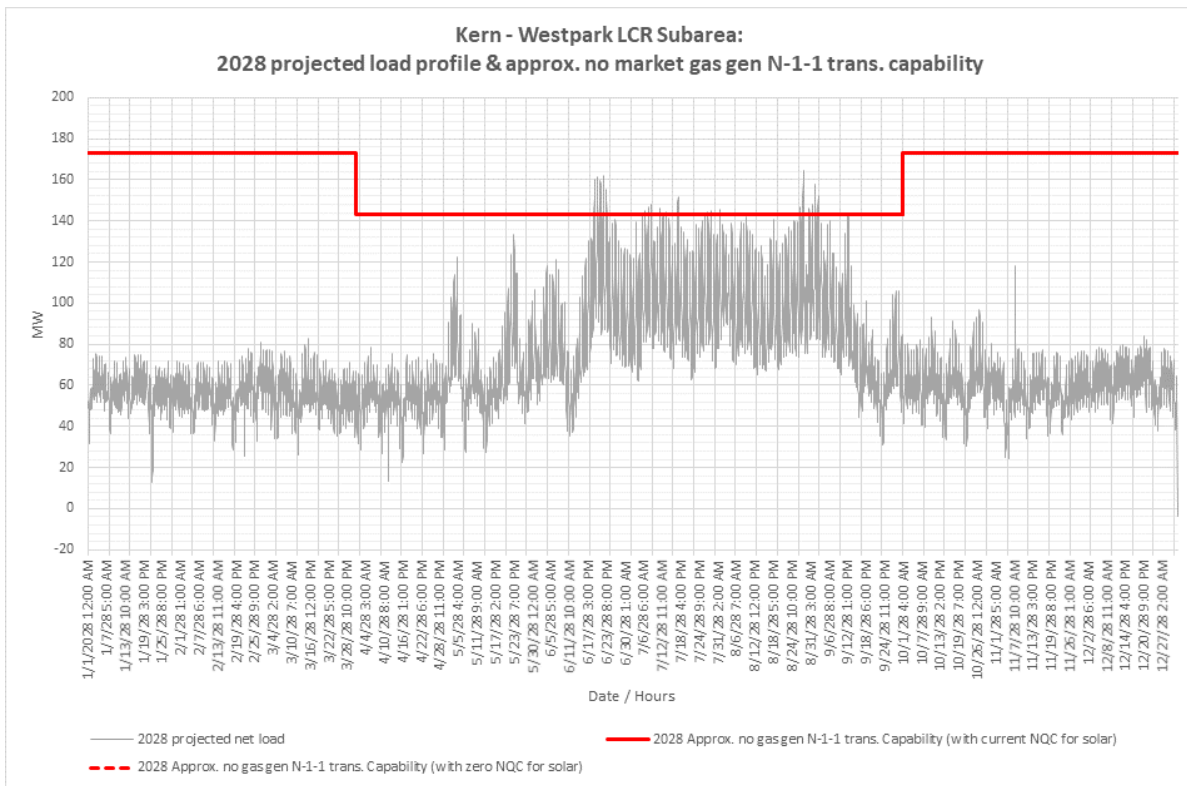
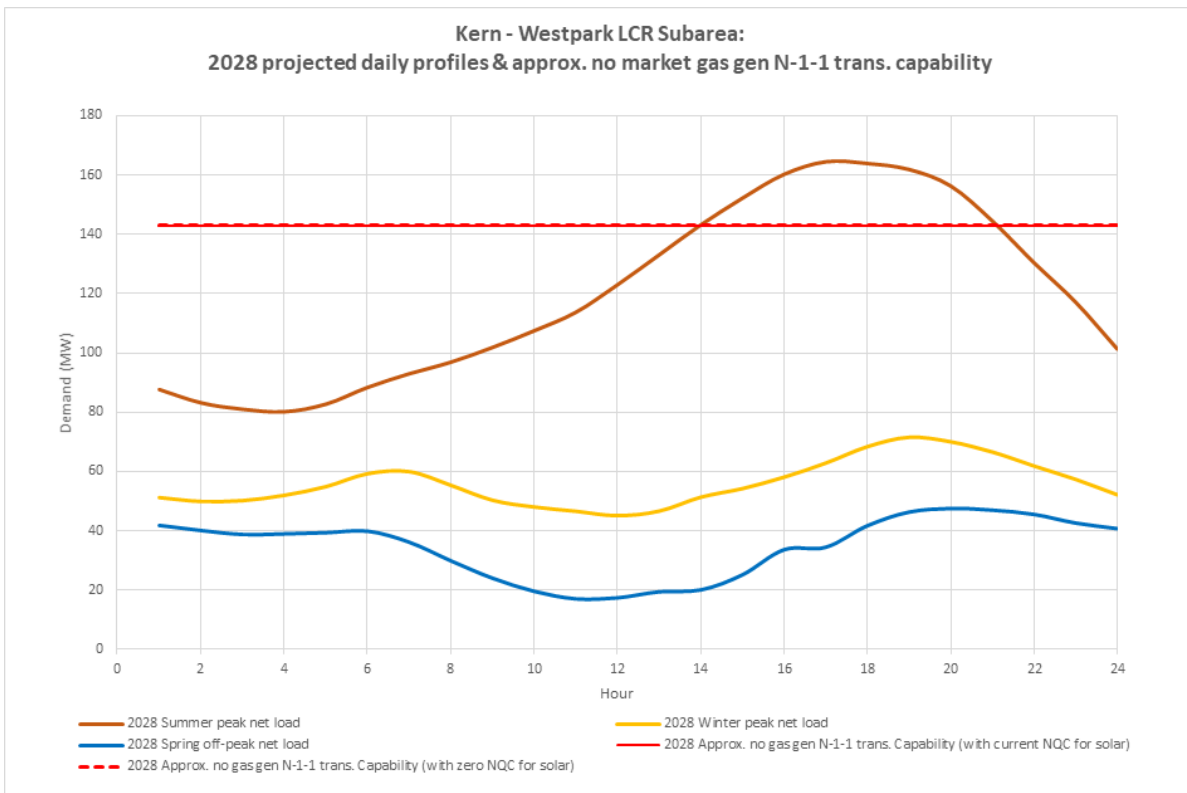

Figure 3.5-72 Westpark LCR Sub-area 2028 Forecast Hourly Profiles



3.5.7.3.4 Westpark LCR Sub-area Requirement

Table 3.5-67 identifies the Westpark 2028 LCR Sub-area requirements. There was no LCR requirement for Category B (Single Contingency) and the LCR Requirement for a Category C (Multiple Contingency) is 42 MW.

Table 3.5-67 Westpark LCR Sub-area Requirements

Year	Limit	Category	Limiting Facility	Contingency	LCR (MW) (Deficiency)
2028	First limit	B	None	None	0
2028	First Limit	C	Kern-West Park #2 115 kV	Kern-West Park #1 115 kV & Magunden – Wheeler Jct. 115 kV	42

3.5.7.3.5 Effectiveness factors:

All units within the Westpark Sub-area have the same effectiveness factor.

For most helpful procurement information please read procedure 2210Z Effectiveness Factors under 7110 (T-138Z) posted at: <http://www.aiso.com/Documents/2210Z.pdf>

3.5.7.3.6 Alternatives to Reduce or Eliminate Gas Generation

As a part of the 2018-2019 transmission planning process the ISO undertook an assessment in approximately half of the LCR areas and LCR Sub-areas to determine potential transmission alternatives to reduce or eliminate the need for gas-fired generation to meet the LCR requirement. The Westpark Sub-area was identified for assessment. The LCR Sub-area is currently dependent on gas-fired generation to meet the LCR requirement. The identified limiting facility, Kern-West Park #1 and #2 115 kV lines is currently going through a re-rating review by PG&E. If this line is re-rated then the LCR requirement will be eliminated for the Westpark Sub-area.

3.5.7.4 **Kern Oil Sub-area**

Kern Oil is a Sub-area of the Kern LCR Area.

3.5.7.4.1 **Kern Oil LCR Sub-area Diagram**

Figure 3.5-73 Kern Oil LCR Sub-area

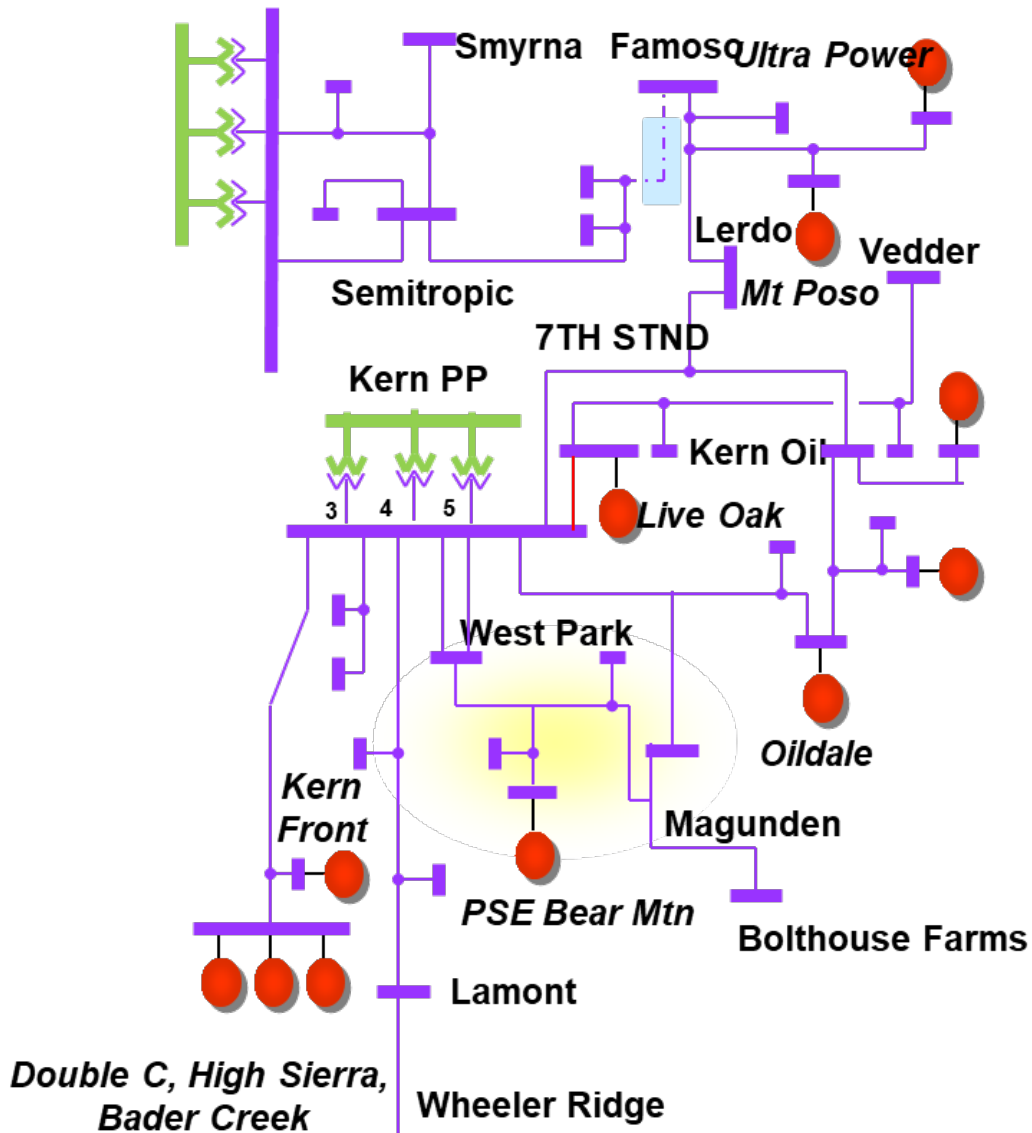

3.5.7.4.2 **Kern Oil LCR Sub-area Load and Resources**

Table 3.5-68 provides the forecast load and resources in Kern Oil LCR Sub-area in 2028. The list of generators within the LCR Sub-area are provided in Attachment A.

Table 3.5-68 Kern Oil LCR Sub-area 2028 Forecast Load and Resources

Load (MW)		Generation (MW)	
Gross Load	667	Market Gas	60
AAEE	-42	Other Gas	3
Behind the meter DG	0	Non-Gas	66
Net Load	625		
Transmission Losses	7		
Pumps	0	Total Qualifying Capacity	129
Load + Losses + Pumps	632		

3.5.7.4.3 Kern Oil LCR Sub-area Hourly Profiles

Figure 3.5-74 illustrates the forecast 2028 profile for the summer peak, winter peak and spring off-peak days for the Kern Oil LCR Sub-area with the Category C (Multiple Contingency) transmission capability with no market gas. Figure 3.5-75 illustrates the forecast 2028 hourly profile for Kern Oil LCR Sub-area with the Category C (Multiple Contingency) transmission capability with no market gas. The red dotted line in the figures represents the transmission capability with no market gas and the solar output in the area output of zero MW.

Figure 3.5-74 Kern Oil LCR Sub-area 2028 Peak Day Forecast Profiles

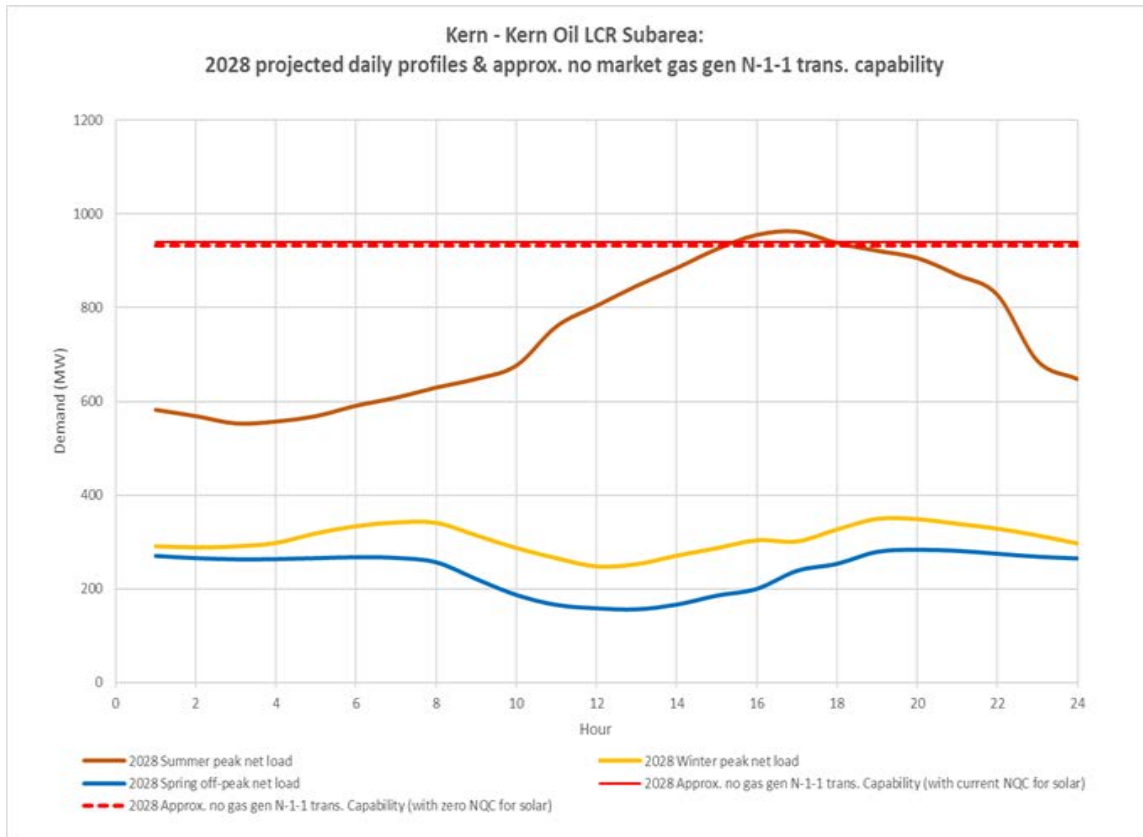
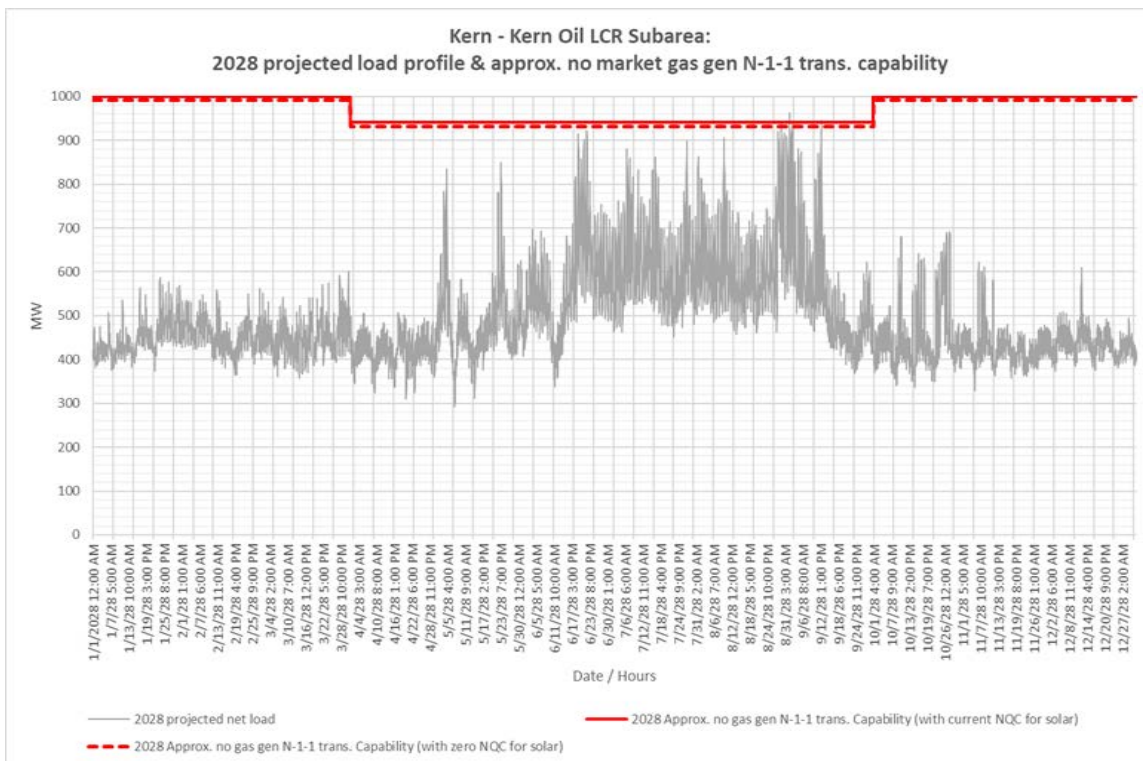

Figure 3.5-75 Kern Oil LCR Sub-area 2028 Forecast Hourly Profiles



3.5.7.4.4 Kern Oil LCR Sub-area Requirement

Table 3.5-69 identifies the Kern Oil 2028 LCR Sub-area requirements. There was no LCR requirement for Category B (Single Contingency) and the LCR Requirement for a Category C (Multiple Contingency) is 67 MW. The second, third and fourth limiting facility and contingency has been provided for information only.

Table 3.5-69 Kern Oil LCR Sub-area Requirements

Year	Limit	Category	Limiting Facility	Contingency	LCR (MW) (Deficiency)
2028	First limit	B	None	None	0
2028	First limit	C	Live Oak – Kern Power 115 kV	Kern-Magunden-Witco and Kern PP-7 th Standard 115 kV	67
2028	Second Limit	C	KernPP – 7 Standard 115 kV	Kern-Live Oak 115 kV & Kern-Magunden-Witco 115 kV	62
2028	Third Limit	C	Multiple Sections between Kern Oil and Kern Oil Jct.	Kern-Live Oak 115 kV & Kern PP-7 th Standard 115 kV	62
2028	Fourth Limit	C	Kern Oil Jct. to Kern Water section	Kern-Live Oak 115 kV & Kern PP-7 th Standard 115 kV	10

3.5.7.4.5 Effectiveness factors:

All units within the Kern Oil Sub-area have the same effectiveness factor.

For most helpful procurement information please read procedure 2210Z Effectiveness Factors under 7110 (T-138Z) posted at: <http://www.aiso.com/Documents/2210Z.pdf>

3.5.7.4.6 Alternatives to Reduce or Eliminate Gas Generation

As a part of the 2018-2019 transmission planning process the ISO undertook an assessment in approximately half of the LCR areas and LCR Sub-areas to determine potential transmission alternatives to reduce or eliminate the need for gas-fired generation to meet the LCR requirement. Alternatives in the Kern Oil Sub-area were assessed. The following alternatives were considered.

- Increase the scope of Kern-Live Oak reconductor
- Reconductor Kern Power-7Standard 115 kV and rerate sections of line between 7 standard and Kern Oil substations.
- Reconductor sections of line between Kern oil and Kern oil Junction and Increase the scope of Kern Power-Kern Oil Jn from rerate to reconductor.

Table 3.5-70 provides the LCR requirement for the alternatives identified above. For the alternatives that reduced the LCR requirement but did not eliminate the requirement, the limiting facility and contingency have been provided.

Table 3.5-70 Alternatives to Reduce or Eliminate the Kern Oil Sub-Area Requirement for Gas-fired generation

Year	Limit	Category	Limiting Facility	Contingency	LCR (MW) (Deficiency)
Increase the scope of Kern-Live Oak reconductor					
2028	First limit	C	KernPP – 7 Standard 115 kV	Kern-Live Oak 115 kV & Kern-Magunden-Witco 115 kV	62
Reconductor Kern Power-7Standard 115 kV and rerate sections of line between 7 standard and Kern Oil substations.					
2028	Second limit	C	Multiple Sections between Kern Oil and Kern Oil Jct.	Kern-Live Oak 115 kV & Kern PP-7 th Standard 115 kV	62
Reconductor sections of line between Kern oil and Kern oil Junction and Increase the scope of Kern Power-Kern Oil Jn from rerate to reconductor					
2028	Third limit	C	Kern Oil Jct. to Kern Water section	Kern-Live Oak 115 kV & Kern PP-7 th Standard 115 kV	10

Table 3.5-71 provides the cost estimates and the total Pease LCR Sub-area requirement and portion of requirement that would need to be supplied from gas-fired and non gas generation for the alternatives identified above.

Table 3.5-71 Alternative Cost Estimate and LCR Requirement

Alternatives	Submitted By	Estimated Cost (\$M)	Requirement (MW)			
			Total	Market Gas	Other Gas	Non-Gas
Increase the scope of Kern-Live Oak reconductor	ISO	\$5	62	16	0	46
Reconductor Kern Power-7Standard 115 kV and rerate sections of line between 7 standard and Kern Oil substations	ISO	\$15	62	16	0	46
Reconductor sections of line between Kern oil and Kern oil Junction and Increase the scope of Kern Power-Kern Oil Jn from rerate to reconductor	ISO	\$15	10	0	0	10

The following two alternatives only reduce the Kern Oil Sub-area requirement by 5 MW with still a requirement of 16 MW required from gas-fired generation.

- Increase the scope of Kern-Live Oak reconductor
- Reconductor Kern Power-7Standard 115 kV and rerate sections of line between 7 standard and Kern Oil substations.

- Reconductor sections of line between Kern oil and Kern oil Junction.

The alternative to Reconductor sections of line between Kern Oil and Kern oil Junction and increase the scope of Kern Power-Kern Oil Jn from rerate to reconductor project reduces the Kern Oil Sub-area need to 10 MW with no requirement from gas-fired generation. The economic assessment of the elimination of the gas-fired generation to address the Kern Oil LCR requirement of the alternative to to Increase the scope of Kern Power-Kern Oil Jct. from rerate to reconductor project is in section 1.9.6 in Chapter 4.

3.5.7.5 *South Kern PP Sub-area*

South Kern PP is Sub-area of the Kern LCR Area. The 2028 LCT study identified that there is enough resources among the rest of the sub-areas therefore this requirement is non-binding.

3.5.7.6 *Kern Area Overall Requirements*

3.5.7.6.1 *Kern LCR Area Overall Requirement*

Table 3.5-72 identifies the limiting facility and contingency that establishes the Kern Area 2028 LCR requirements. There are no LCR requirement for Category B (Single Contingency) and for Category C (Multiple Contingency) the LCR requirement is 140 MW with a 3 MW deficiency. The Category C (Multiple Contingency) is based upon the aggregate of the Sub-areas.

Table 3.5-72 Kern Overall LCR Sub-area Requirements

Year	Limit	Category	Limiting Facility	Contingency	LCR (MW) (Deficiency)
2028	First limit	B	None	None	0
2028	First Limit	C	Aggregate of Sub-areas.		140 (3)

3.5.7.6.2 *Changes compared to 2023 requirements*

Compared with 2023 the load forecast increased by over 200 MW due to area definition change. The LCR need has decreased by 42 MW mainly due to new transmission projects.

3.5.7.6.3 *Alternatives to Reduce or Eliminate Gas Generation*

As a part of the 2018-2019 transmission planning process the ISO undertook an assessment in approximately half of the LCR areas and LCR Sub-areas to determine potential transmission alternatives to reduce or eliminate the need for gas-fired generation to meet the LCR requirement. The previous approved transmission projects identified in section 3.2.7.1.4 reduces the 2028 LCR requirements in the Kern Area. In addition the potential alternatives identified in the Kern PP 70 kV and Kern Oil Sub-areas along with the potential rerating being reviewed in the Westpark Sub-area would further reduce the Kern area LCR requirement. The current requirement is driven by constraints on the 70 kV and 115 kV in the Kern Area. If these constraints are addressed then

the requirement would be reduced to 82 MW with the constratin on the 230 kV system which could be potentially be further addressed with an SPS. The ISO will continue to monitor if the rerating identified is feasible and the economic assessment of alternatives to addres the Kern Oil Sub-area requirement.

3.5.8 Big Creek/Ventura Area

3.5.8.1 *Area Definition:*

The transmission tie lines into the Big Creek/Ventura Area are:

- Antelope #1 500/230 kV Transformer
- Antelope #2 500/230 kV Transformer
- Sylmar - Pardee 230 kV #1 and #2 Lines
- Vincent - Pardee 230 kV #2 Line
- Vincent - Santa Clara 230 kV Line

The substations that delineate the Big Creek/Ventura Area are:

- Antelope 500 kV is out Antelope 230 kV is in
- Antelope 500 kV is out Antelope 230 kV is in
- Sylmar is out Pardee is in
- Vincent is out Pardee is in
- Vincent is out Santa Clara is in

3.5.8.1.1 Big Creek/Ventura LCR Area Diagram

Figure 3.5-76 Big Creek/Ventura LCR Area

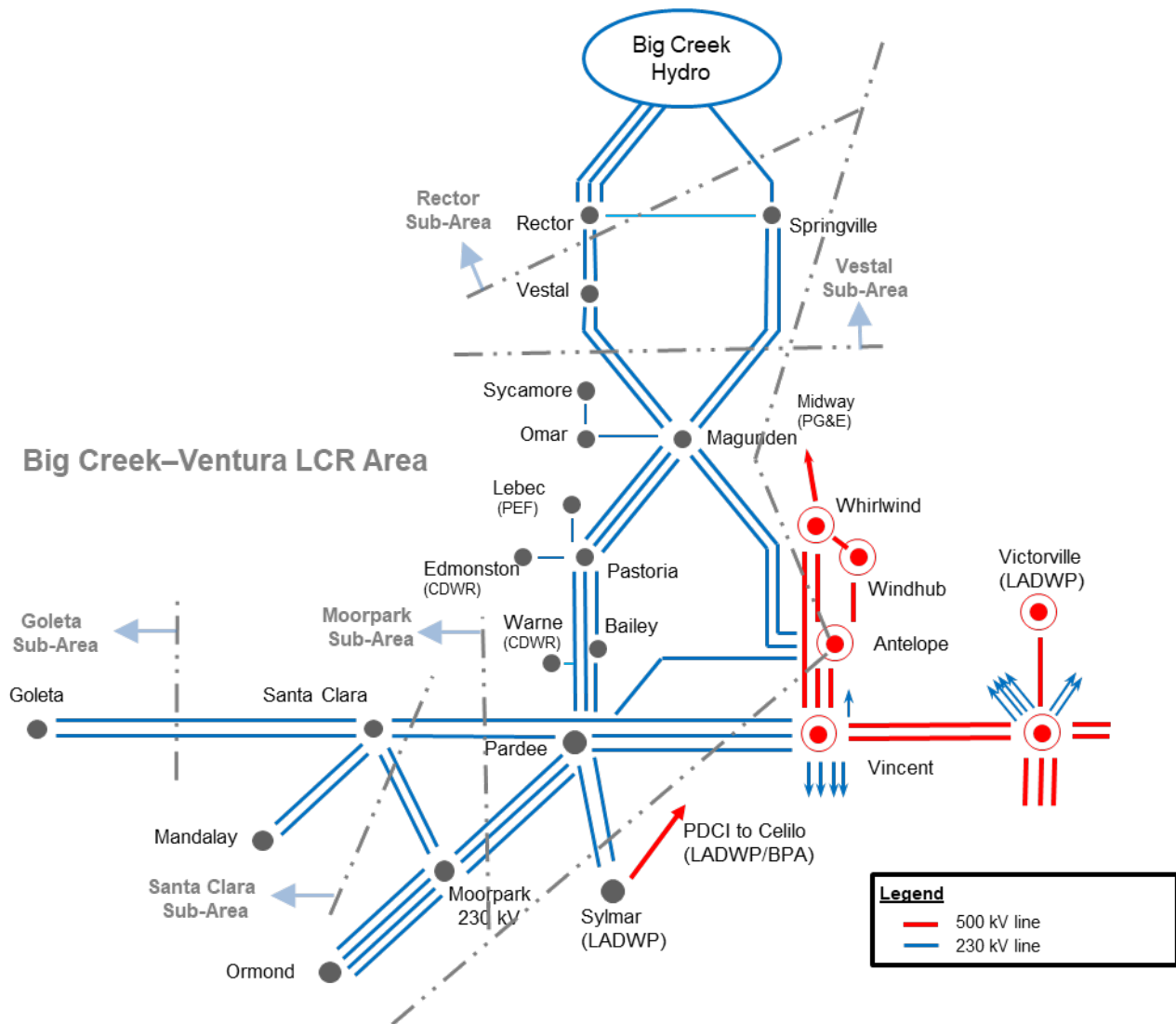

3.5.8.1.2 Big Creek/Ventura LCR Area Load and Resources

Table 3.5-73 provides the forecast load and resources in the Big Creek/Ventura LCR Area in 2028. The list of generators within the LCR area are provided in Attachment A and does not include new LTPP preferred resources as well as existing 20-minute DR.

Table 3.5-73 Big Creek/Ventura LCR Area 2028 Forecast Load and Resources

Load (MW)		Generation (MW)	
Gross Load	5,457	Market	2975
AAEE	-301	MUNI	372
Behind the meter DG	-609	QF	52

Net Load	4,547	LTPP Preferred Resources	112
Transmission Losses	105	Existing 20-minute Demand Response	0
Pumps	379	Mothballed	0
Load + Losses + Pumps	5,031	Total Qualifying Capacity	3511

3.5.8.1.3 Approved transmission projects modeled:

- Big Creek Corridor Rating Increase Project (ISD - 12/31/2018).
- Pardee-Moorpark No. 4 230 kV Transmission Circuit (ISD – 12/31/2020)

3.5.8.2 Rector Sub-area

LCR need is satisfied by the need in the larger Vestal sub-area.

3.5.8.3 Vestal Sub-area

Vestal is Sub-area of the Big Creek/Ventura LCR Area.

3.5.8.3.1 Vestal LCR Sub-area Diagram

Figure 3.5-77 Vestal LCR Sub-area

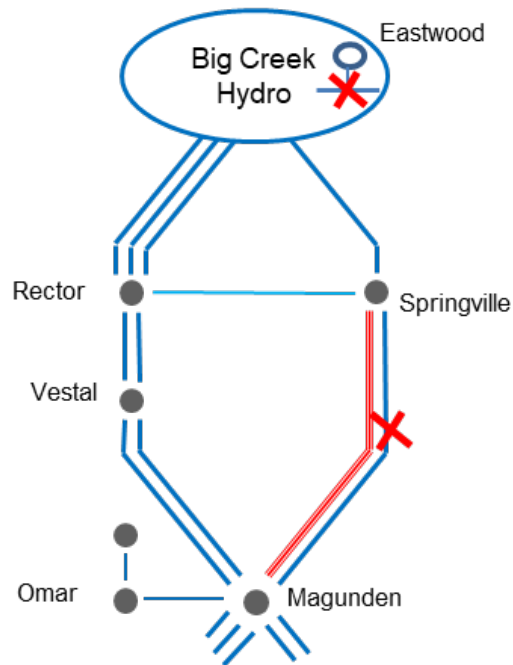

3.5.8.3.2 Vestal LCR Sub-area Load and Resources

Table 3.5-74 provides the forecast load and resources in Vestal LCR Sub-area in 2028. The list of generators within the LCR Sub-area are provided in Attachment A.

Table 3.5-74 Vestal LCR Sub-area 2028 Forecast Load and Resources

Load (MW)		Generation (MW)	
Gross Load	1601	Market	1114
AAEE	77	MUNI	0
Behind the meter DG	201	QF	2
Net Load	1323	LTPP Preferred Resources	0
Transmission Losses	29	Existing 20-minute Demand Response	57
Pumps	0	Mothballed	0
Load + Losses + Pumps	1352	Total Qualifying Capacity	1173

3.5.8.3.3 Vestal LCR Sub-area Hourly Profiles

Figure 3.5-78 illustrates the forecast 2028 profile for the summer peak day in the Vestal LCR Sub-area.

Figure 3.5-78 Vestal LCR Sub-area 2028 Peak Day Forecast Profiles

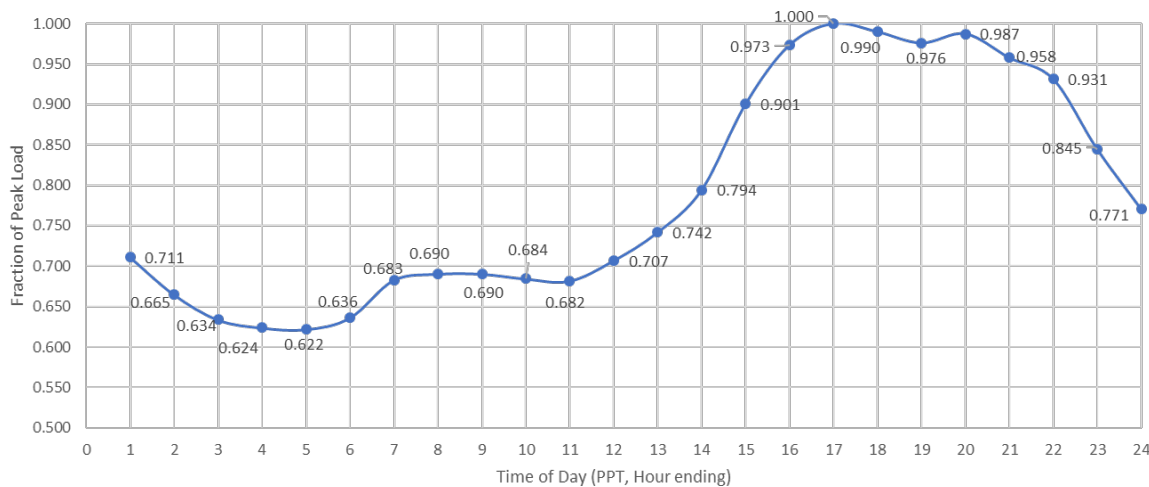

3.5.8.3.4 Vestal LCR Sub-area Requirement

Table 3.5-75 identifies the Vestal 2028 LCR Sub-area requirements. The Category B (Single Contingency) LCR requirement and the LCR requirement for Category C (Multiple Contingency) are 465 MW.

Table 3.5-75 Vestal LCR Sub-area Requirements

Year	Limit	Category	Limiting Facility	Contingency	LCR (MW) (Deficiency)
2028	First Limit	B/C	Magunden-Springville #2 230 kV	Magunden-Springville #1 230 kV with Eastwood out of service	465
2028	First Limit	B/C	Remaining Magunden-Vestal 230 kV line	One of the Magunden-Vestal 230 kV lines with Eastwood unit out of service	465

3.5.8.3.5 Effectiveness factors:

For helpful procurement information please read procedure 2210Z Effectiveness Factors under 7500 posted at: <http://www.caiso.com/Documents/2210Z.pdf>

3.5.8.3.6 Alternatives to Reduce or Eliminate Gas Generation

As a part of the 2018-2019 transmission planning process the ISO undertook an assessment in approximately half of the LCR areas and LCR Sub-areas to determine potential transmission alternatives to reduce or eliminate the need for gas-fired generation to meet the LCR requirement. In the 2018-2019 transmission planning process the Vestal LCR Sub-Area was not selected to assess alternatives to reduce or eliminate the requirement for gas-fired generation to address the LCR requirement.

3.5.8.4 Goleta Sub-area

Goleta is Sub-area of the Big Creek/Ventura LCR Area.

3.5.8.4.1 Goleta LCR Sub-area Diagram

Figure 3.5-79 Goleta LCR Sub-area

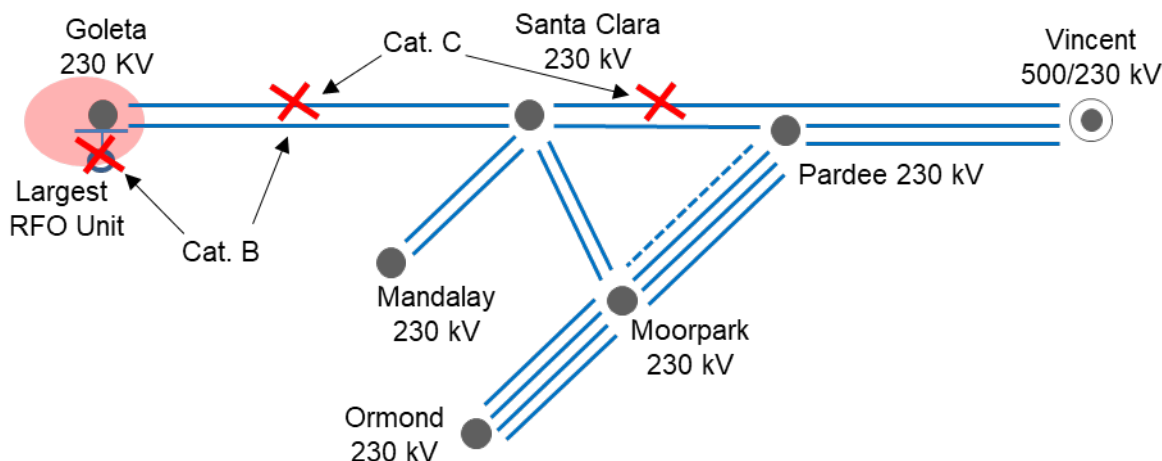

3.5.8.4.2 Goleta LCR Sub-area Load and Resources

Table 3.5-76 provides the forecast load and resources in Goleta LCR Sub-area in 2028. The list of generators within the LCR Sub-area are provided in Attachment A.

Table 3.5-76 Goleta LCR Sub-area 2028 Forecast Load and Resources

Load (MW)		Generation (MW)	
Gross Load	351	Market	3
AAEE	18	MUNI	0
Behind the meter DG	25	QF	0
Net Load	308	LTPP Preferred Resources	2
Transmission Losses	0	Existing 20-minute Demand Response	2
Pumps	0	Mothballed	7
Load + Losses + Pumps	308	Total Qualifying Capacity	14

3.5.8.4.3 Goleta LCR Sub-area Hourly Profiles

Figure 3.5-80 illustrates the forecast 2028 profile for the summer peak day in the Goleta LCR Sub-area.

Figure 3.5-80 Goleta LCR Sub-area 2028 Peak Day Forecast Profiles

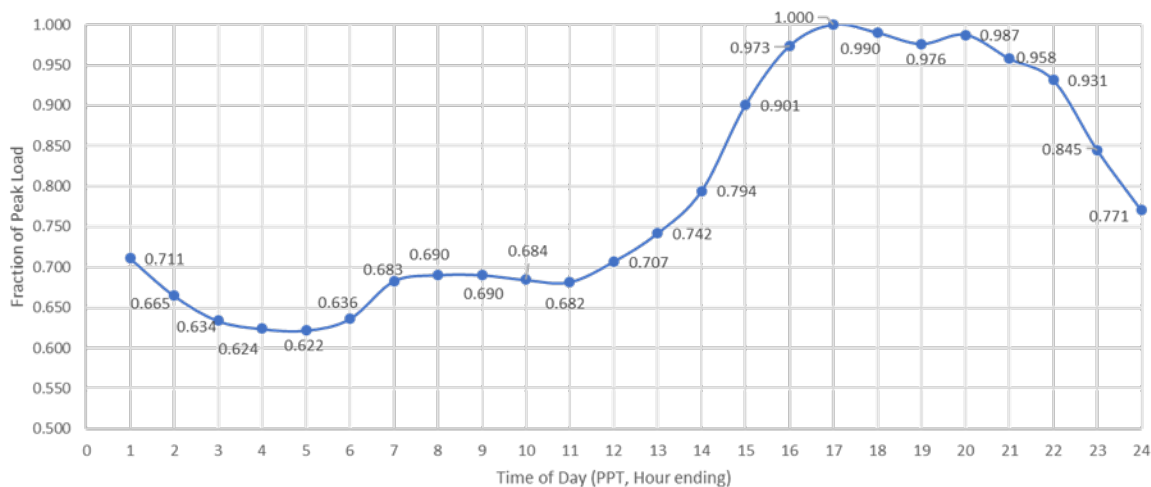

3.5.8.4.4 Goleta LCR Sub-area Requirement

Table 3.5-77 identifies the Goleta 2028 LCR Sub-area requirements. The Category B (Single Contingency) LCR requirement and the LCR requirement for Category C (Multiple Contingency) are 465 MW.

Table 3.5-77 Goleta LCR Sub-area Requirements

Year	Limit	Category	Limiting Facility	Contingency	LCR (MW) (Deficiency)
2028	First Limit	B	Low voltage at Goleta substation	One of the Santa Clara–Goleta 230 kV lines with the largest Santa Clara LCR RFP unit	32 MW plus the largest LCR RFP unit
2028	First Limit	C	Low voltage at Goleta substation	One of the Santa Clara–Goleta 230 kV lines and Vincent – Santa Clara 230 kV line	42 (28)

3.5.8.4.5 Effectiveness factors:

For helpful procurement information please read procedure 2210Z Effectiveness Factors under 7500 posted at: <http://www.caiso.com/Documents/2210Z.pdf>

3.5.8.4.6 Alternatives to Reduce or Eliminate Gas Generation

As a part of the 2018-2019 transmission planning process the ISO undertook an assessment in approximately half of the LCR areas and LCR Sub-areas to determine potential transmission alternatives to reduce or eliminate the need for gas-fired generation to meet the LCR requirement. In the 2018-2019 transmission planning process the Goleta LCR Sub-Area was not selected to assess alternatives to reduce or eliminate the requirement for gas-fired generation to address the LCR requirement.

3.5.8.5 Santa Clara Sub-area

Santa Clara is Sub-area of the Big Creek/Ventura LCR Area.

3.5.8.5.1 Santa Clara LCR Sub-area Diagram

Figure 3.5-81 Santa Clara LCR Sub-area

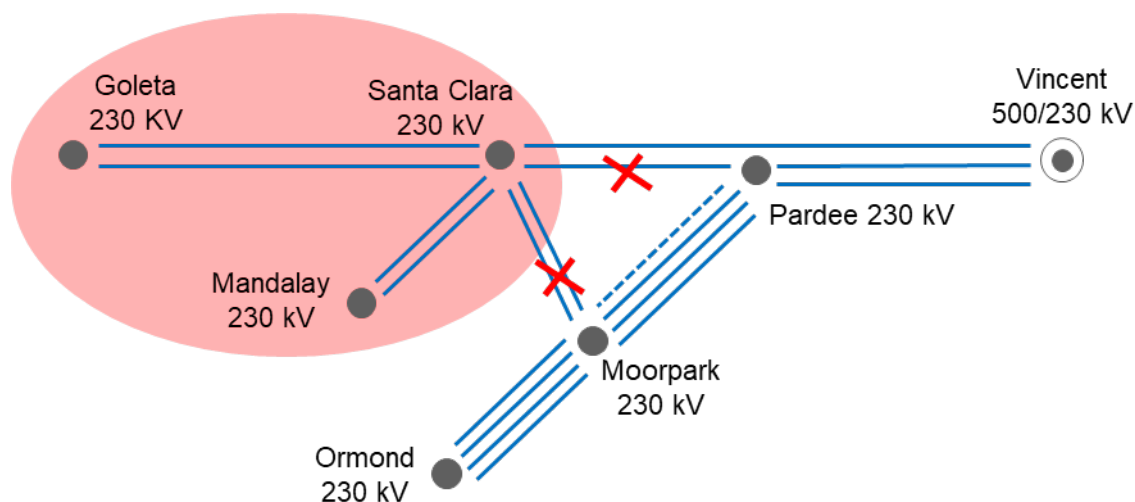

3.5.8.5.2 Santa Clara LCR Sub-area Load and Resources

Table 3.5-78 provides the forecast load and resources in Santa Clara LCR Sub-area in 2028. The list of generators within the LCR Sub-area are provided in Attachment A.

Table 3.5-78 Santa Clara LCR Sub-area 2028 Forecast Load and Resources

Load (MW)		Generation (MW)	
Gross Load	1034	Market	149
AAEE	58	MUNI	0
Behind the meter DG	103	QF	37
Net Load	873	LTPP Preferred Resources	2
Transmission Losses	2.1	Existing 20-minute Demand Response	9
Pumps	0	Mothballed	7
Load + Losses + Pumps	875	Total Qualifying Capacity	204

3.5.8.5.3 Santa Clara LCR Sub-area Hourly Profiles

Figure 3.5-82 illustrates the forecast 2028 profile for the summer peak day in the Santa Clara LCR Sub-area.

Figure 3.5-82 Santa Clara LCR Sub-area 2028 Peak Day Forecast Profiles

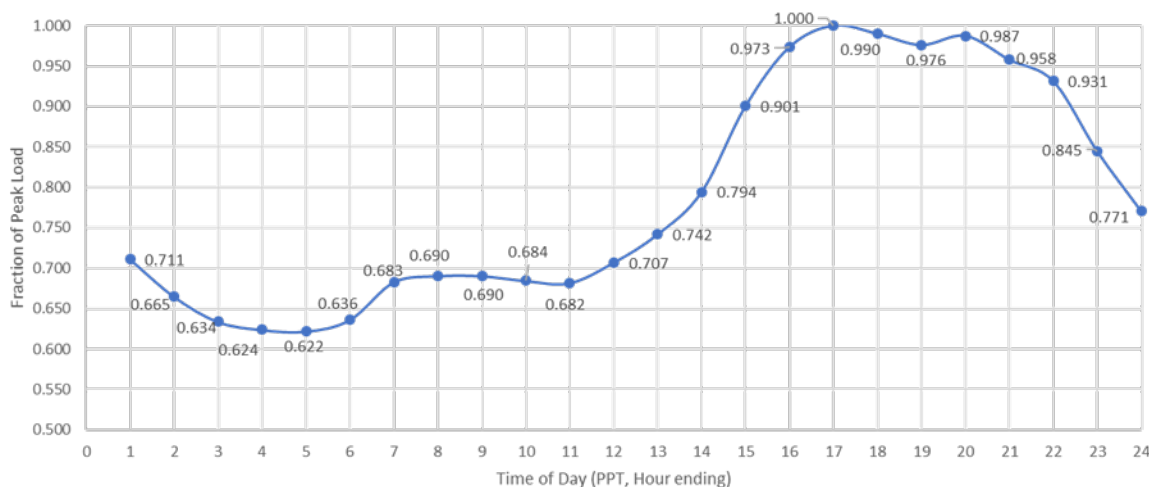

3.5.8.5.4 Santa Clara LCR Sub-area Requirement

Table 3.5-79 identifies the Santa Clara 2028 LCR Sub-area requirements. The Category B (Single Contingency) LCR requirement and the LCR requirement for Category C (Multiple Contingency) are 318 MW including 120 MW of deficiency.

Table 3.5-79 Santa Clara LCR Sub-area Requirements

Year	Limit	Category	Limiting Facility	Contingency	LCR (MW) (Deficiency)
2028	First Limit	B	None	None	0
2028	First Limit	C	Voltage collapse	Pardee - Santa Clara 230 kV followed by Moorpark - Santa Clara #1 & #2 230 kV	318 (114)

3.5.8.5.5 Effectiveness factors:

For helpful procurement information please read procedure 2210Z Effectiveness Factors under 7500 posted at: <http://www.caiso.com/Documents/2210Z.pdf>

3.5.8.5.6 Alternatives to Reduce or Eliminate Gas Generation

As a part of the 2018-2019 transmission planning process the ISO undertook an assessment in approximately half of the LCR areas and LCR Sub-areas to determine potential transmission alternatives to reduce or eliminate the need for gas-fired generation to meet the LCR requirement. In the 2018-2019 transmission planning process the Santa Clara LCR Sub-Area was not selected

to assess alternatives to reduce or eliminate the requirement for gas-fired generation to address the LCR requirement.

3.5.8.6 Moorpark Sub-area

Moorpark is a Sub-area of the Big Creek/Ventura LCR Area. The 2028 LCT study identified that the Moorpark Sub-area will no longer be required due to the Pardee-Moorpark No. 4 230 kV Transmission Circuit project being in-service.

3.5.8.7 Big Creek/Ventura Overall

3.5.8.7.1 Big Creek/Ventura LCR Sub-area Hourly Profiles

Figure 3.5-83 illustrates the forecast 2028 profile for the summer peak day in the Big Creek/Ventura LCR area.

Figure 3.5-83 Big Creek/Ventura LCR area 2028 Peak Day Forecast Profiles

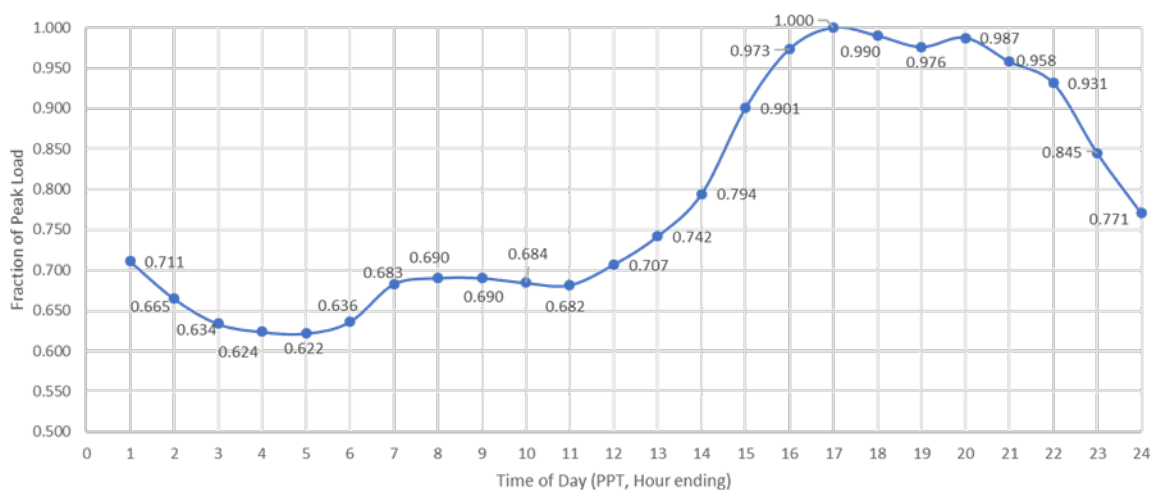

3.5.8.7.2 Big Creek/Ventura LCR area Requirement

Table 3.5-80 identifies the Big Creek/Ventura 2028 LCR area requirements. The Category B (Single Contingency) LCR requirement is 2095 MW and the LCR requirement for Category C (Multiple Contingency) is 2131 MW.

Table 3.5-80 Big Creek/Ventura LCR area Requirements

Year	Limit	Category	Limiting Facility	Contingency	LCR (MW) (Deficiency)
2028	First Limit	B	Remaining Sylmar - Pardee 230 kV	One of the Sylmar - Pardee 230 kV lines with Pastoria power plant (CCGT) out of service	2,095

2028	First Limit	C	Remaining Sylmar - Pardee 230 kV	Lugo - Victorville 500 kV line followed by one of the Sylmar - Pardee 230 kV lines	2,131
------	-------------	---	-------------------------------------	---	-------

3.5.8.7.3 Effectiveness factors:

For helpful procurement information please read procedure 2210Z Effectiveness Factors under 7680 (T-130Z), 7510 (T-163Z), 7550 (T-159Z) and 8610 (T-131Z) posted at: <http://www.caiso.com/Documents/2210Z.pdf>

3.5.8.7.4 Changes compared to 2023 LCT study

Compared with the results for 2023 the load forecast is down by 138 MW and the LCR need has decreased by 439 MW due to the decrease in the load forecast as well as other changes in the system.

3.5.8.7.5 Alternatives to Reduce or Eliminate Gas Generation

As a part of the 2018-2019 transmission planning process the ISO undertook an assessment in approximately half of the LCR areas and LCR Sub-areas to determine potential transmission alternatives to reduce or eliminate the need for gas-fired generation to meet the LCR requirement. In the 2018-2019 transmission planning process the Big Creek/Ventura LCR Area was not selected to assess alternatives to reduce or eliminate the requirement for gas-fired generation to address the LCR requirement.

3.5.9 LA Basin Area

3.5.9.1 Area Definition:

The transmission tie lines into the LA Basin Area are:

- San Onofre - San Luis Rey #1, #2, and #3 230 kV Lines
- San Onofre - Talega #2 230 kV Lines
- San Onofre - Capistrano #1 230 kV Lines
- Lugo - Mira Loma #2 & #3 500 kV Lines
- Lugo - Rancho Vista #1 500 kV Line
- Vincent – Mesa 500 kV Line
- Sylmar - Eagle Rock 230 kV Line
- Sylmar - Gould 230 kV Line
- Vincent - Mesa #1 & #2 230 kV Lines
- Vincent - Rio Hondo #1 & #2 230 kV Lines
- Devers - Red Bluff 500 kV #1 and #2 Lines

- Mirage – Coachela Valley # 1 230 kV Line
- Mirage - Ramon # 1 230 kV Line
- Mirage - Julian Hinds 230 kV Line

The substations that delineate the LA Basin Area are:

- San Onofre is in San Luis Rey is out
- San Onofre is in Talega is out
- San Onofre is in Capistrano is out
- Mira Loma is in Lugo is out
- Rancho Vista is in Lugo is out
- Eagle Rock is in Sylmar is out
- Gould is in Sylmar is out
- Mira Loma is in Vincent is out
- Mesa is in Vincent is out
- Rio Hondo is in Vincent is out
- Devers is in Red Bluff is out
- Mirage is in Coachela Valley is out
- Mirage is in Ramon is out
- Mirage is in Julian Hinds is out

3.5.9.1.1 LA Basin LCR Area Diagram

Figure 3.5-84 LA Basin LCR Area

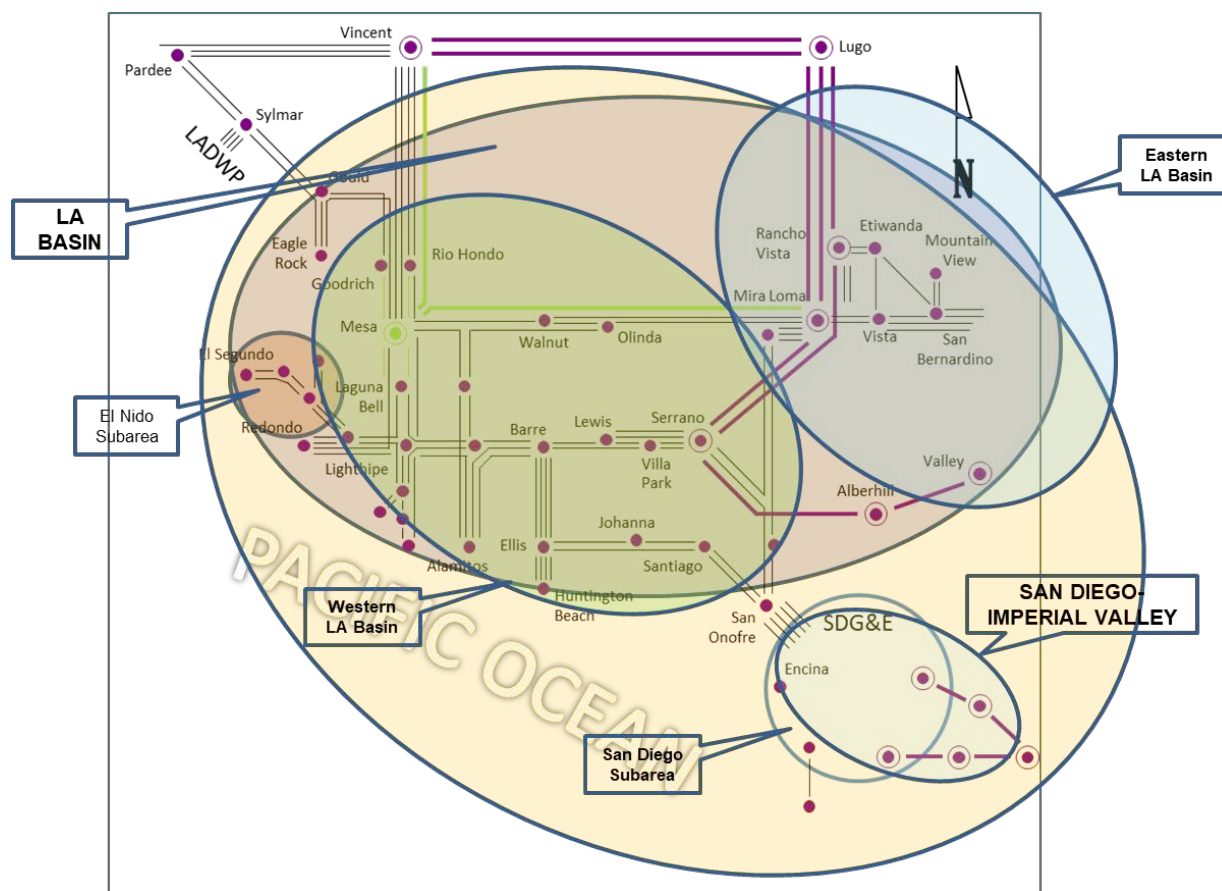

3.5.9.1.2 LA Basin LCR Area Load and Resources

Table 3.5-81 provides the forecast load and resources in the LA Basin LCR Area in 2028. The list of generators within the LCR area are provided in Attachment A and does not include new LTPP preferred resources as well as existing 20-minute DR.

Table 3.5-81 LA Basin LCR Area 2028 Forecast Load and Resources

Load (MW)		Generation (MW)	
Gross Load	23,604	Market	5,680
AAEE+AAPV	-2,145	MUNI	1,164
Behind the meter DG	-2,207	QF	279
Net Load	19,252	LTPP Preferred Resources	432
Transmission Losses	351	Existing 20-minute Demand Response	294
Pumps	22	Mothballed	435
Load + Losses + Pumps	19,625	Total Qualifying Capacity	8,284

3.5.9.1.3 Approved transmission projects modeled:

- Mesa Loop-In Project and Laguna Bell Corridor 230 kV line upgrades
- Delaney – Colorado River 500 kV Line
- Hassayampa – North Gila #2 500 kV Line (APS)
- West of Devers 230 kV line upgrades
- CPUC-approved long-term procurement plan (431 MW) in the western LA Basin sub-area
- Retirement of 1,356 MW of the existing Redondo Beach OTC generation
- Alamitos repowering (640 MW)
- Retirement of 2,010 MW of the existing Alamitos OTC generation
- Huntington Beach repowering (644 MW)
- Retirement of 452 MW of the existing Huntington Beach OTC generation
- Stanton Energy Reliability Center (98 MW)

3.5.9.2 El Nido Sub-area

El Nido is Sub-area of the LA Basin LCR Area.

3.5.9.2.1 El Nido LCR Sub-area Diagram

Please refer to Figure 3.5-84 above.

3.5.9.2.2 El Nido LCR Sub-area Load and Resources

Table 3.5-82 provides the forecast load and resources in El Nido LCR Sub-area in 2028. The list of generators within the LCR Sub-area are provided in Attachment A.

Table 3.5-82 El Nido LCR Sub-area 2028 Forecast Load and Resources

Load (MW)		Generation (MW)	
Gross Load	1825	Market	538
AAEE + AAPV	120	MUNI	0
Behind the meter DG	135	QF	0
Net Load	1570	LTPP Preferred Resources	41
Transmission Losses	7	Existing 20-minute Demand Response	10
Pumps	0	Mothballed	0
Load + Losses + Pumps	1577	Total Qualifying Capacity	589

3.5.9.2.3 EI Nido LCR Sub-area Hourly Profiles

Figure 3.5-85 illustrates the forecast 2028 profile for the summer peak day in the EI Nido LCR Sub-area.

Figure 3.5-85 EI Nido LCR Sub-area 2028 Peak Day Forecast Profiles

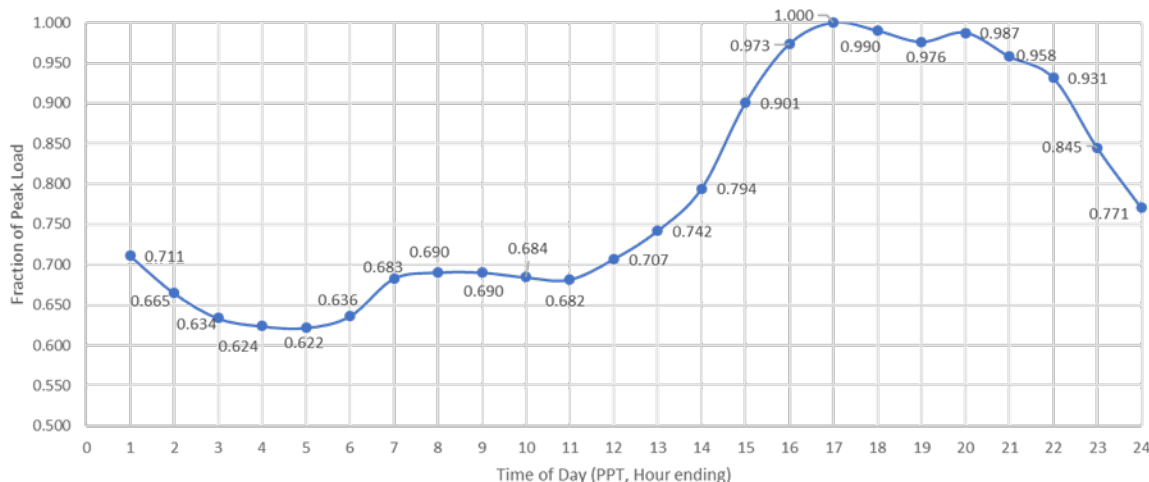

3.5.9.2.4 EI Nido LCR Sub-area Requirement

Table 3.5-83 identifies the EI Nido 2028 LCR Sub-area requirements. There is no Category B (Single Contingency) LCR requirement and the LCR requirement for Category C (Multiple Contingency) is 400 MW.

Table 3.5-83 EI Nido LCR Sub-area Requirements

Year	Limit	Category	Limiting Facility	Contingency	LCR (MW) (Deficiency)
2028	First Limit	B	None	None	0
2028	First Limit	C	La Fresa – La Cienega 230 kV	La Fresa – El Nido #3 230 kV La Fresa – El Nido #4 230 kV	400

3.5.9.2.5 Effectiveness factors:

All units within the EI Nido Sub-area have the same effectiveness factor.

For most helpful procurement information please read procedure 2210Z Effectiveness Factors under 7630 (G-219Z) posted at: <http://www.caiso.com/Documents/2210Z.pdf>

3.5.9.2.6 Alternatives to Reduce or Eliminate Gas Generation

As a part of the 2018-2019 transmission planning process the ISO undertook an assessment in approximately half of the LCR areas and LCR Sub-areas to determine potential transmission alternatives to reduce or eliminate the need for gas-fired generation to meet the LCR requirement. In the 2018-2019 transmission planning process the El Nido LCR Sub-Area was not selected to assess alternatives to reduce or eliminate the requirement for gas-fired generation to address the LCR requirement.

3.5.9.3 Western LA Basin Sub-area

Western LA Basin is Sub-area of the LA Basin LCR Area.

3.5.9.3.1 Western LA Basin LCR Sub-area Diagram

Please refer to Figure 3.5-84 above.

3.5.9.3.2 Western LA Basin LCR Sub-area Load and Resources

Table 3.5-84 provides the forecast load and resources in Western LA Basin LCR Sub-area in 2028. The list of generators within the LCR Sub-area are provided in Attachment A.

Table 3.5-84 Western LA Basin Sub-area 2028 Forecast Load and Resources

Load (MW)		Generation (MW)	
Gross Load	13128	Market	3175
AAEE + AAPV	1036	MUNI	582
Behind the meter DG	1308	QF	105
Net Load	10784	LTPP Preferred Resources	432
Transmission Losses	35	Existing 20-minute Demand Response	154
Pumps	0	Mothballed	0
Load + Losses + Pumps	10819	Total Qualifying Capacity	4448

3.5.9.3.3 Western LA Basin LCR Sub-area Hourly Profiles

Figure 3.5-86 illustrates the forecast 2028 profile for the summer peak day in the Western LA Basin LCR Sub-area.

Figure 3.5-86 Western LA Basin LCR Sub-area 2028 Peak Day Forecast Profiles

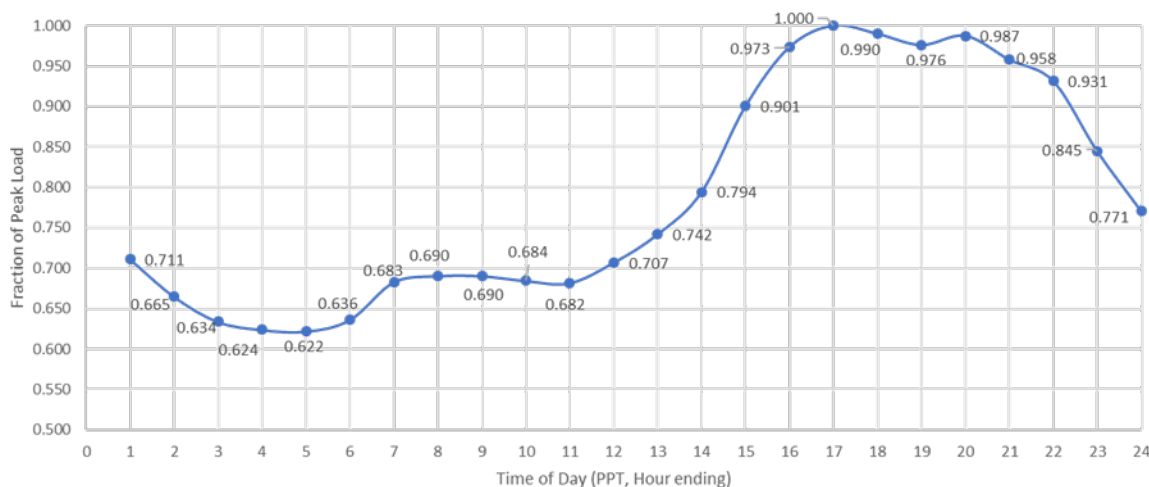

3.5.9.3.4 Western LA Basin LCR Sub-area Requirement

Table 3.5-85 identifies the Western LA Basin 2028 LCR Sub-area requirements. There is no Category B (Single Contingency) LCR requirement and the LCR requirement for Category C (Multiple Contingency) is 3912 MW.

Table 3.5-85 Western LA Basin LCR Sub-area Requirements

Year	Limit	Category	Limiting Facility	Contingency	LCR (MW) (Deficiency)
2028	First Limit	B	None-binding	Multiple combinations possible	N/A
2028	First Limit	C	Thermal overload of Mesa – Laguna Bell #1 230 kV	Mesa – Redonndo #1 230 kV Mesa – Lighthipe 230 kV	3,912

3.5.9.3.5 Effectiveness factors:

See Attachment B - Table titled [LA Basin](#).

For other helpful procurement information please read procedure 2210Z Effectiveness Factors under 7630 (G-219Z) posted at: <http://www.caiso.com/Documents/2210Z.pdf>

There are other combinations of contingencies in the area that could overload a significant number of 230 kV lines in this sub-area have less LCR need. As such, anyone of them (combination of contingencies) could become binding for any given set of procured resources. As a result, these effectiveness factors may not be the best indicator towards informed procurement.

3.5.9.3.6 Alternatives to Reduce or Eliminate Gas Generation

As a part of the 2018-2019 transmission planning process the ISO undertook an assessment in approximately half of the LCR areas and LCR Sub-areas to determine potential transmission alternatives to reduce or eliminate the need for gas-fired generation to meet the LCR requirement. In the 2018-2019 transmission planning process the Western LA Basin LCR Sub-Area was not selected to assess alternatives to reduce or eliminate the requirement for gas-fired generation to address the LCR requirement.

3.5.9.4 *West of Devers Sub-area*

West of Devers is a Sub-area of the LA Basin LCR Area. The 2028 LCT study identified that the West of Devers Sub-area will no longer be required due to the Mesa Loop-in as well as West of Devers reconductoring projects being in-service.

3.5.9.5 *Valley-Devers Sub-area*

Valley-Devers is a Sub-area of the LA Basin LCR Area. The 2028 LCT study identified that the Valley-Devers Sub-area will no longer be required due to the Colorado River-Delaney 500 kV line project being in-service.

3.5.9.6 *Valley Sub-area*

Valley is a Sub-area of the LA Basin LCR Area. The 2028 LCT study identified that the Valley Sub-area will no longer be required due to the Colorado River-Delaney 500 kV line project being in-service.

3.5.9.7 *Eastern LA Basin Sub-area*

Eastern LA Basin is Sub-area of the LA Basin LCR Area.

3.5.9.7.1 Eastern LA Basin LCR Sub-area Diagram

Please refer to Figure 3.5-84 above.

3.5.9.7.2 Eastern LA Basin LCR Sub-area Load and Resources

Table 3.5-86 provides the forecast load and resources in Eastern LA Basin LCR Sub-area in 2028. The list of generators within the LCR Sub-area are provided in Attachment A.

Table 3.5-86 Eastern LA Basin Sub-area 2028 Forecast Load and Resources

Load (MW)		Generation (MW)	
Gross Load	8845	Market	2604
AAEE + AAPV	-582	MUNI	582
Behind the meter DG	704	QF	174
Net Load	7559	LTPP Preferred Resources	0
Transmission Losses	29	Existing 20-minute Demand Response	141
Pumps	22	Mothballed	335
Load + Losses + Pumps	7588	Total Qualifying Capacity	3836

3.5.9.7.3 Eastern LA Basin LCR Sub-area Hourly Profiles

Figure 3.5-87 illustrates the forecast 2028 profile for the summer peak day in the Eastern LA Basin LCR Sub-area.

Figure 3.5-87 Eastern LA Basin LCR Sub-area 2028 Peak Day Forecast Profiles

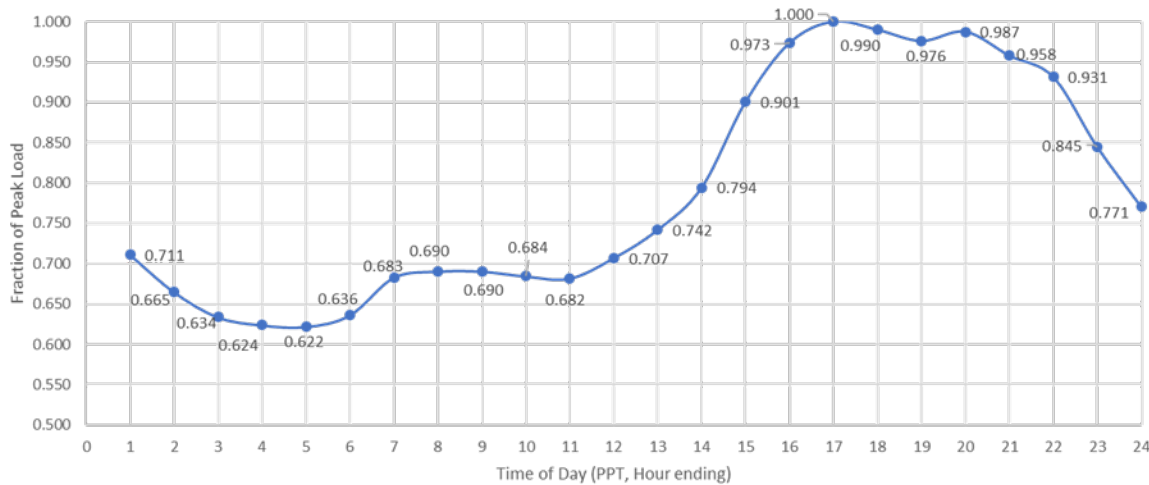

3.5.9.7.4 Eastern LA Basin LCR Sub-area Requirement

Table 3.5-87 identifies the Eastern LA Basin 2028 LCR Sub-area requirements. There is no Category B (Single Contingency) LCR requirement and the LCR requirement for Category C (Multiple Contingency) is 2678 MW.

Table 3.5-87 Eastern LA Basin LCR Sub-area Requirements

Year	Limit	Category	Limiting Facility	Contingency	LCR (MW) (Deficiency)
2028	First Limit	B	None-binding	Multiple combinations possible	N/A
2028	First Limit	C	Post transient voltage stability	Serrano – Valley 500 kV, followed by Devers – Red Bluff #1 and #2 500 kV	2,678

3.5.9.7.5 Effectiveness factors:

All units within the Eastern LA Basin Sub-area have the same effectiveness factor.

For most helpful procurement information please read procedure 2210Z Effectiveness Factors under 7630 (G-219Z) posted at: <http://www.caiso.com/Documents/2210Z.pdf>

3.5.9.7.6 Alternatives to Reduce or Eliminate Gas Generation

As a part of the 2018-2019 transmission planning process the ISO undertook an assessment in approximately half of the LCR areas and LCR Sub-areas to determine potential transmission alternatives to reduce or eliminate the need for gas-fired generation to meet the LCR requirement. Alternatives in the Eastern Sub-area were assessed. The following alternatives were considered.

- Install approximately 225 MVAR synchronous condenser at Mira Loma 500 kV substation.
- Red Bluff-Mira Loma 500 kV transmission project.

Table 3.5-88 provides the LCR requirement for the alternatives identified above. For the alternatives that reduced the LCR requirement but did not eliminate the requirement, the limiting facility and contingency have been provided.

Table 3.5-88 Alternatives to Reduce or Eliminate the Eastern Sub-Area Requirement for Gas-fired generation

Year	Limit	Category	Limiting Facility	Contingency	LCR (MW) (Deficiency)
Install approximately 225 MVAR synchronous condenser at Mira Loma 500 kV substation.					
2028	First limit	C	Same	Same	2,328
Red Bluff – Mira Loma 500 kV Transmission Project.					
2028	First limit	C	Same	Same	2,587

Table 3.5-89 provides the cost estimates and the total Eastern LCR Sub-area requirement and portion of requirement that would need to be supplied from gas-fired and non gas generation for the alternatives identified above

Table 3.5-89 Alternative Cost Estimate and LCR Requirement

Alternatives	Submitted By	Estimated Cost (\$M)	Requirement (MW)		
			Total	Market Gas Decrease (ELA)	Market Gas Increase (WLA)
Install approximately 225 MVAR synchronous condenser at Mira Loma 500 kV substation.	ISO	\$30-\$80	2,328	350	0
Red Bluff – Mira Loma 500 kV Transmission Project.	NEET West	\$850	2,587	91	30

3.5.9.8 LA Basin Overall

3.5.9.8.1 LA Basin LCR Sub-area Hourly Profiles

Figure 3.5-88 illustrates the forecast 2028 profile for the summer peak day in the LA Basin LCR area.

At SCE peak time, SDG&E load is represented at 91.51% of its own (SDG&E) peak demand.

Figure 3.5-88 LA Basin LCR area 2028 Peak Day Forecast Profiles

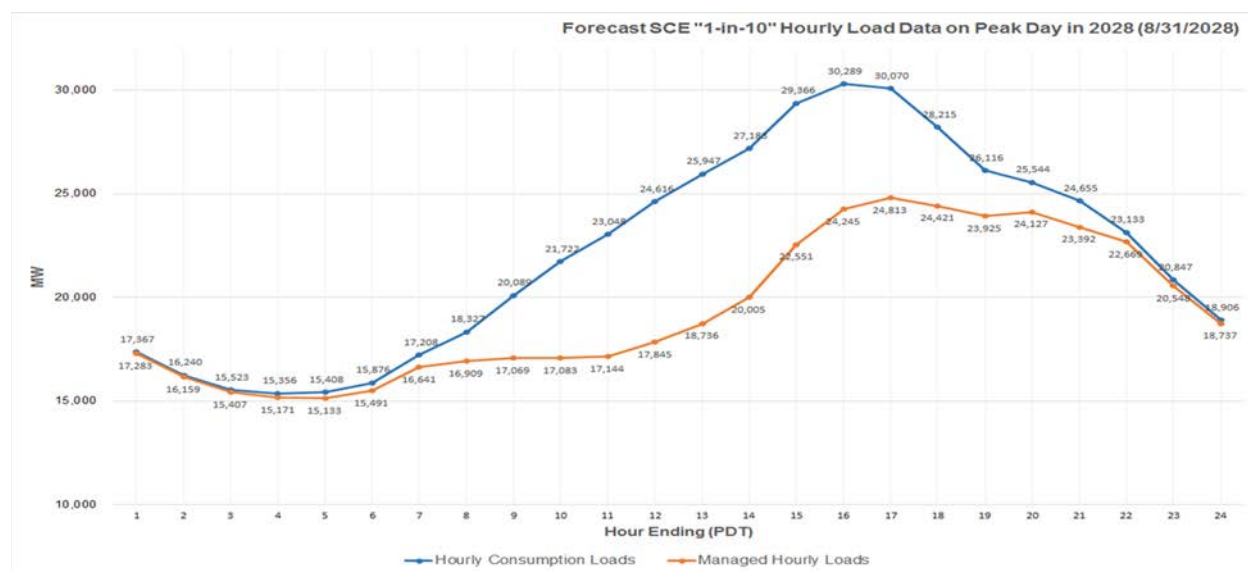

3.5.9.8.2 LA Basin LCR area Requirement

Table 3.5-90 and Table 3.5-91 identify the LA Basin 2028 LCR area requirements with dispatch at NQC values and output at 8:00 PM respectively. Ther Category B (Single Contingency) LCR

requirement is 5526 MW and the LCR requirement for Category C (Multiple Contingency) is 6590 MW. The second limiting facility and contingency has been provided for information only.

Table 3.5-90 LA Basin LCR area Requirements with dispatch at NQC value

Year	Limit	Category	Limiting Facility	Contingency	LCR (MW) (Deficiency)
2028	First Limit	B	El Centro 230/92 kV bank	TDM, system readjustment and Imperial Valley – North Gila 500 kV	5,526
2028	Second Limit	B	Mesa – Laguna Bell #1 230 kV	Huntington Beach CCGT, system readjustment and Mesa – Laguna Bell #2 230 kV	5,326
2028	First Limit	C	Mesa – Laguna Bell #1 230 kV	Mesa – Redonndo #1 230 kV Mesa – Lighthipe 230 kV	6,590

Table 3.5-91 LA Basin LCR area Requirements with dispatch at 8:00 PM

Year	Limit	Category	Limiting Facility	Contingency	LCR (MW) (Deficiency)
2028	First Limit	B/C	El Centro 230/92 kV bank	TDM, system readjustment and Imperial Valley – North Gila 500 kV	6,874

Due to the interaction of the greater LA Basin-San Diego-Imperial Valley area and the fact that San Diego-Imperial Valley has used all available resources it was necessary to increase the requirements in the LA Basin for the case with 8:00 PM hour dispatch.

3.5.9.8.3 Effectiveness factors:

See Attachment B - Table titled [LA Basin](#).

For other helpful procurement information please read procedure 2210Z Effectiveness Factors under 7570 (T-144Z), 7580 (T-139Z), 7590 (T-137Z, 6750) and 7680 (T-130Z) posted at: <http://www.caiso.com/Documents/2210Z.pdf>

There are other combinations of contingencies in the area that could overload a significant number of 230 kV lines in this sub-area have less LCR need. As such, anyone of them (combination of contingencies) could become binding for any given set of procured resources.

As a result, these effectiveness factors may not be the best indicator towards informed procurement.

3.5.9.8.4 Changes compared to 2023 LCT study

Compared with 2023, the load forecast is lower by 447 MW and the LCR need has decreased by 203 MW, primarily due to lower demand forecast in the case of NQC dispatch and increased by 81 MW at 8:00 PM dispatch mainly due to effective solar resources in San Diego-Imperial Valley not being available.

3.5.9.8.5 Alternatives to Reduce or Eliminate Gas Generation

As a part of the 2018-2019 transmission planning process the ISO undertook an assessment in approximately half of the LCR areas and LCR Sub-areas to determine potential transmission alternatives to reduce or eliminate the need for gas-fired generation to meet the LCR requirement. In the 2018-2019 transmission planning process the LA Basin LCR Area was not selected to assess alternatives to reduce or eliminate the requirement for gas-fired generation to address the LCR requirement.

3.5.10 San Diego-Imperial Valley Area

3.5.10.1 Area Definition:

The transmission tie lines forming a boundary around the Greater San Diego-Imperial Valley area include:

- Imperial Valley – North Gila 500 kV Line
- Otay Mesa – Tijuana 230 kV Line
- San Onofre - San Luis Rey #1 230 kV Line
- San Onofre - San Luis Rey #2 230 kV Line
- San Onofre - San Luis Rey #3 230 kV Line
- San Onofre – Talega 230 kV Line
- San Onofre – Capistrano 230 kV Line
- Imperial Valley – El Centro 230 kV Line
- Imperial Valley – La Rosita 230 kV Line

The substations that delineate the Greater San Diego-Imperial Valley area are:

- Imperial Valley is in North Gila is out
- Otay Mesa is in Tijuana is out
- San Onofre is out San Luis Rey is in
- San Onofre is out San Luis Rey is in
- San Onofre is out San Luis Rey is in

- San Onofre is out Talega is in
- San Onofre is out Capistrano is in
- Imperial Valley is in El Centro is out
- Imperial Valley is in La Rosita is out

3.5.10.1.1 San Diego-Imperial Valley LCR Area Diagram

Figure 3.5-89 San Diego-Imperial Valley LCR Area

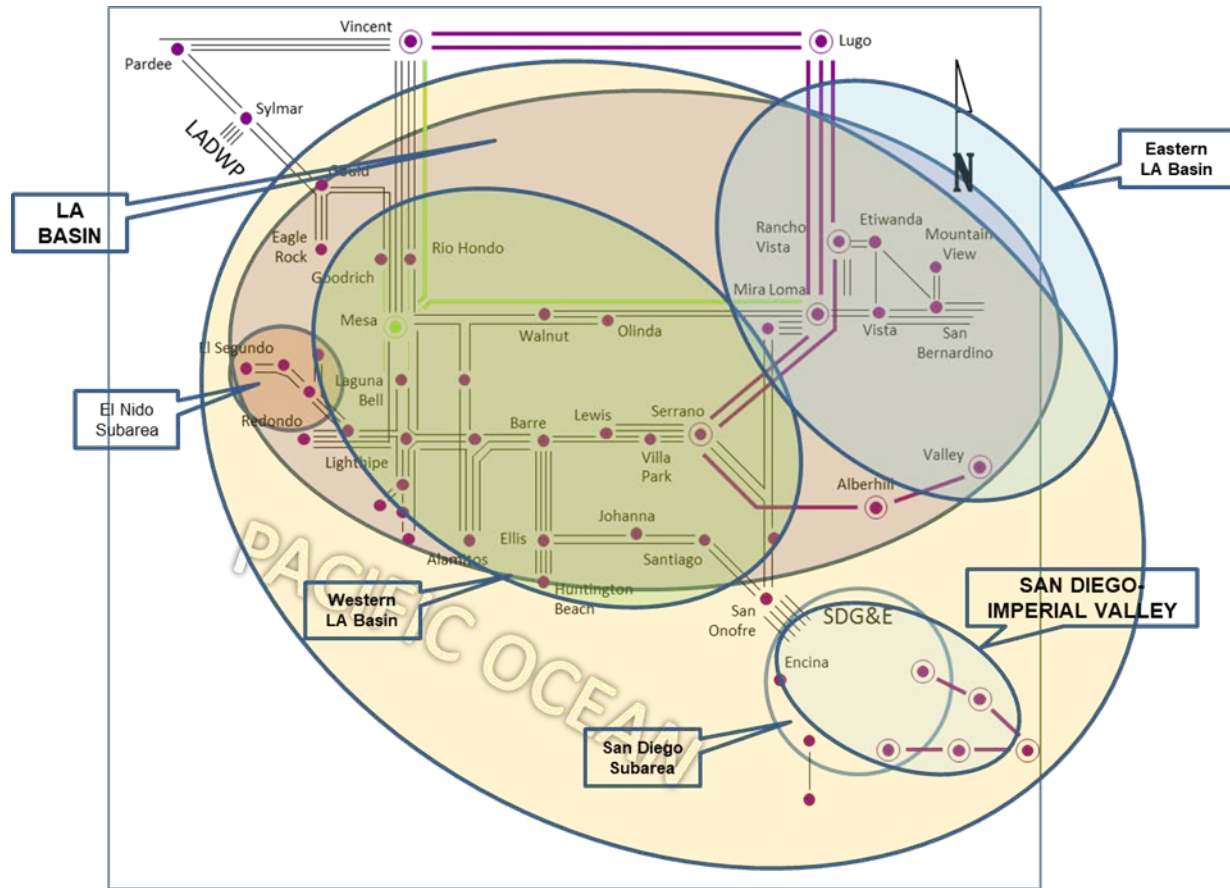

3.5.10.1.2 San Diego-Imperial Valley LCR Area Load and Resources

Table 3.5-92 provides the forecast load and resources in the San Diego-Imperial Valley LCR Area in 2028. The list of generators within the LCR area are provided in Attachment A.

Table 3.5-92 San Diego-Imperial Valley LCR Area 2028 Forecast Load and Resources

Load (MW)		Generation (MW)	
Gross Load	5,752	Market	4,362
AAEE	-362	MUNI	0
Behind the meter DG	-853	QF	106

Net Load	4,537	LTPP Preferred Resources	24
Transmission Losses	134	Existing 20-minute Demand Response	16
Pumps	0	Mothballed	0
Load + Losses + Pumps	4,671	Total Qualifying Capacity	4,508

3.5.10.1.3 Approved transmission projects modeled:

- Ocean Ranch 69 kV substation
- Mesa Height TL600 Loop-in
- Re-conductor of Mission-Mesa Heights 69 kV
- Re-conductor of Kearny-Mission 69 kV line
- TL6906 Mesa Rim rearrangement
- Upgrade Bernardo - Rancho Carmel 69 kV line
- Re-conductor of Japanese Mesa–Basilone–Talega Tap 69 kV lines
- 2nd Miguel–Bay Boulevard 230 kV line
- Sycamore–Penasquitos 230 kV line
- 2nd Mission 230/69 kV bank
- Suncrest SVC project
- By-passing 500 kV series capacitor banks on the Southwest Powerlink and Sunrise Powerlink lines
- Encina generation retirement
- Carlsbad Energy Center (5x100 MW)
- Battery energy storage projects (total of 78 MW) at various locations
- TL632 Granite loop-in and TL6914 reconfiguration
- 2nd San Marcos–Escondido 69 kV line
- Reconductor of Stuart Tap–Las Pulgas 69 kV line (TL690E)
- 2nd Poway–Pomerado 69 kV line
- Artesian 230 kV expansion with 69 kV upgrade
- South Orange County Reliability Enhancement
- Imperial Valley bank #80 replacement
- Imperial Valley-El Centro 230 kV (“S”) line

3.5.10.2 *El Cajon Sub-area*

El Cajon is Sub-area of the San Diego-Imperial Valley LCR Area.

3.5.10.2.1 El Cajon LCR Sub-area Diagram

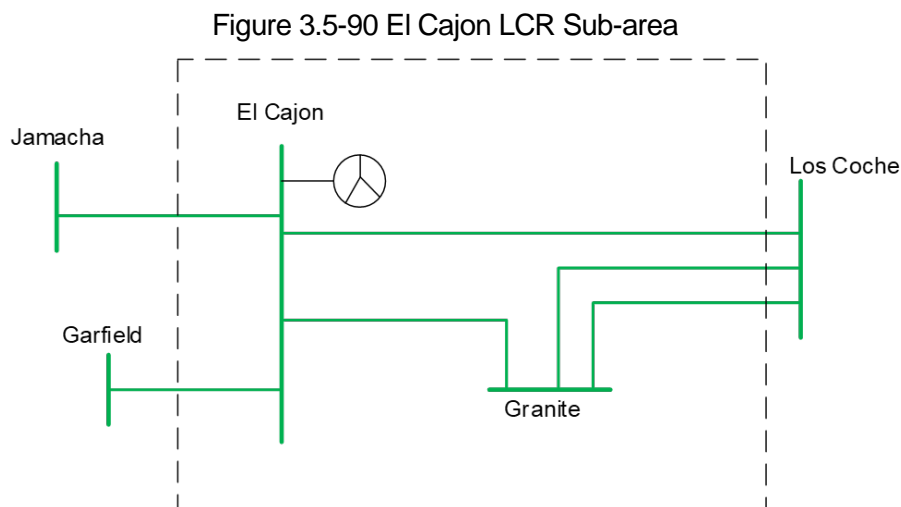

3.5.10.2.2 El Cajon LCR Sub-area Load and Resources

Table 3.5-93 provides the forecast load and resources in El Cajon LCR Sub-area in 2028. The list of generators within the LCR Sub-area are provided in Attachment A.

Table 3.5-93 El Cajon LCR Sub-area 2028 Forecast Load and Resources

Load (MW)		Generation (MW)	
Gross Load	177	Market	101
AAEE	-6	MUNI	0
Behind the meter DG	0	QF	0
Net Load	171	LTPP Preferred Resources	3
Transmission Losses	2	Existing 20-minute Demand Response	4
Pumps	0	Mothballed	0
Load + Losses + Pumps	173	Total Qualifying Capacity	108

3.5.10.2.3 El Cajon LCR Sub-area Hourly Profiles

Figure 3.5-91 illustrates the forecast 2028 profile for the summer peak day in the El Cajon LCR Sub-area with the Category C (Multiple Contingency) transmission capability.

Figure 3.5-91 El Cajon LCR Sub-area 2028 Peak Day Forecast Profiles

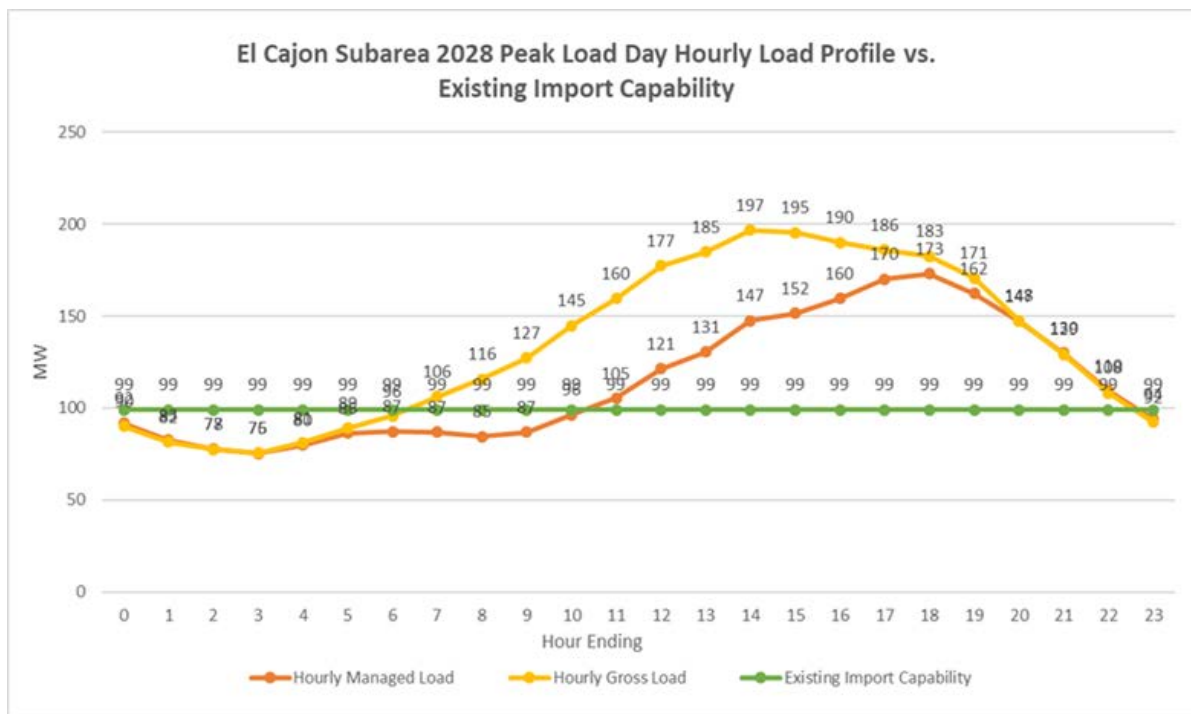

3.5.10.2.4 El Cajon LCR Sub-area Requirement

Table 3.5-94 identifies the El Cajon 2028 LCR Sub-area requirements. There is no Category B (Single Contingency) LCR requirement and the LCR requirement for Category C (Multiple Contingency) is 76 MW.

Table 3.5-94 El Cajon LCR Sub-area Requirements

Year	Limit	Category	Limiting Facility	Contingency	LCR (MW) (Deficiency)
2028	First Limit	B	None	None	0
2028	First Limit	C	El Cajon – Los Coches 69 kV	Granite – Los Coches #1 69 kV Granite – Los Coches #2 69 kV	76

3.5.10.2.5 Effectiveness factors:

All units within the El Cajon Sub-area have the same effectiveness factor.

3.5.10.2.6 Alternatives to Reduce or Eliminate Gas Generation

As a part of the 2018-2019 transmission planning process the ISO undertook an assessment in approximately half of the LCR areas and LCR Sub-areas to determine potential transmission alternatives to reduce or eliminate the need for gas-fired generation to meet the LCR requirement. Alternatives in the El Cajon Sub-area were assessed. The following alternatives were considered.

- Upgrade Los Coches - El Cajon 69 kV line.

Table 3.5-95 provides the LCR requirement for the alternatives identified above. For the alternatives that reduced the LCR requirement but did not eliminate the requirement, the limiting facility and contingency have been provided.

Table 3.5-95 Alternatives to Reduce or Eliminate the El Cajon Sub-Area Requirement for Gas-fired generation

Year	Limit	Category	Limiting Facility	Contingency	LCR (MW) (Deficiency)
Upgrade Los Coches - El Cajon 69 kV line.					
2028	First limit	C			0

Table 3.5-96 provides the cost estimates and the total El Cajon LCR Sub-area requirement and portion of requirement that would need to be supplied from gas-fired and non gas generation for the alternatives identified above

Table 3.5-96 Alternative Cost Estimate and LCR Requirement

Alternatives	Submitted By	Estimated Cost (\$M)	Requirement (MW)			
			Total	Market Gas	Other Gas	Non-Gas
Upgrade Los Coches-El Cajon 69 kV line.	SDG&E	\$28-\$43	0	0	0	0

3.5.10.3 *Mission Sub-area*

Mission is a Sub-area of the San Diego-Imperial Valley LCR Area. The 2028 LCT study identified that the Mission Sub-area will no longer be required due to the TL600 Mesa Heights 69 kV Loop-in and the TL676 Mission-Mesa Heights 69 kV Reconductoring projects being in-service.

3.5.10.4 *Esco Sub-area*

Esco is Sub-area of the San Diego-Imperial Valley LCR Area.

3.5.10.4.1 Esco LCR Sub-area Diagram

Figure 3.5-92 Esco LCR Sub-area

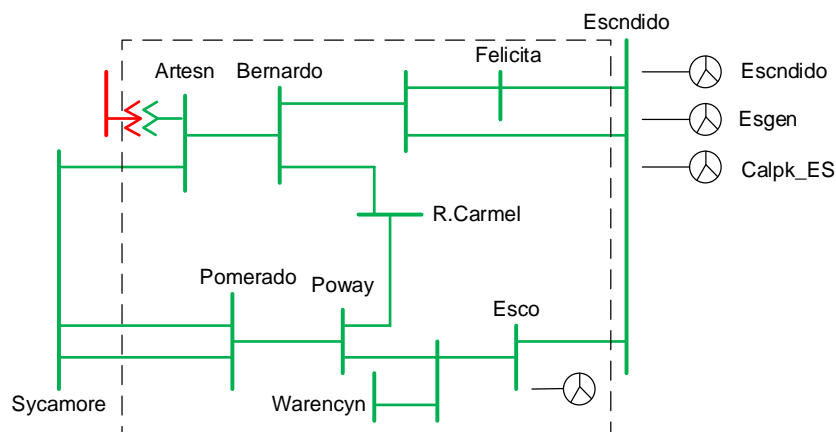

3.5.10.4.2 Esco LCR Sub-area Load and Resources

Table 3.5-97 provides the forecast load and resources in Esco LCR Sub-area in 2028. The list of generators within the LCR Sub-area are provided in Attachment A.

Table 3.5-97 Esco Sub-area 2028 Forecast Load and Resources

Load (MW)		Generation (MW)	
Gross Load	399	Market	203
AAEE	-22	MUNI	0
Behind the meter DG	0	QF	0
Net Load	377	LTPP Preferred Resources	1
Transmission Losses	1	Existing 20-minute Demand Response	2
Pumps	0	Mothballed	0
Load + Losses + Pumps	378	Total Qualifying Capacity	206

3.5.10.4.3 Esco LCR Sub-area Hourly Profiles

Figure 3.5-93 illustrates the forecast 2028 profile for the summer day for in the Esco LCR Sub-area with the Category C (Multiple Contingency) transmission capability.

Figure 3.5-93 Esco LCR Sub-area 2028 Peak Day Forecast Profiles

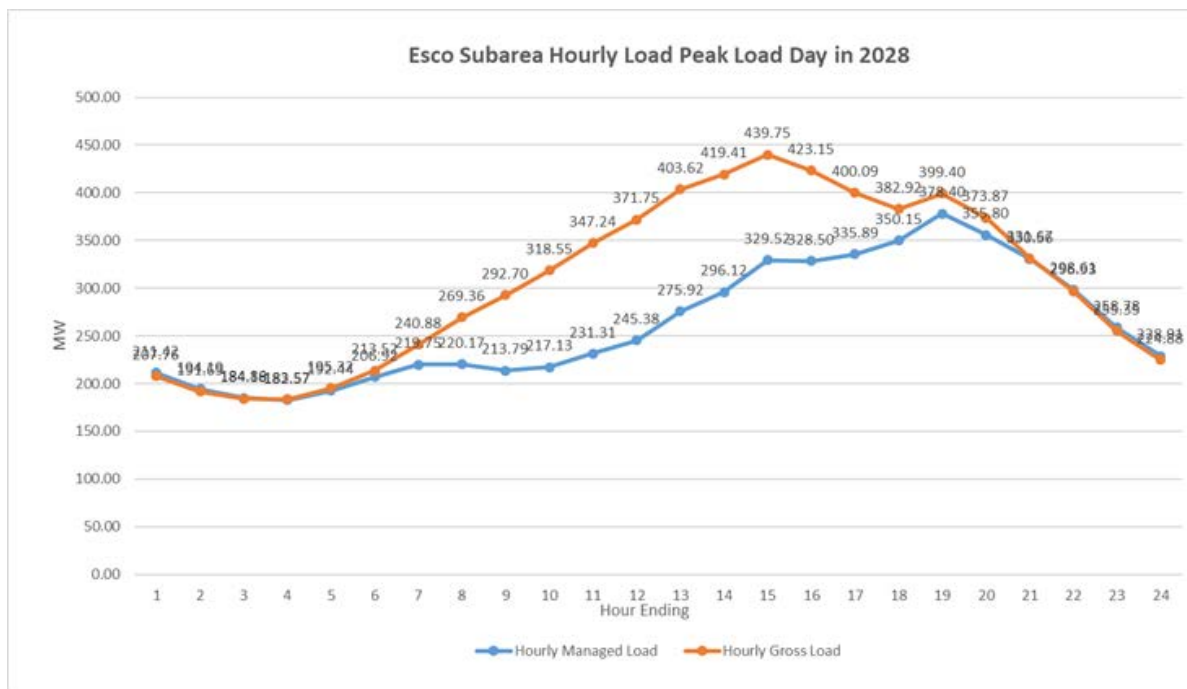

3.5.10.4.4 Esco LCR Sub-area Requirement

Table 3.5-98 identifies the Esco 2028 LCR Sub-area requirements. There is no Category B (Single Contingency) or Category C (Multiple Contingency) LCR requirement.

Table 3.5-98 Esco LCR Sub-area Requirements

Year	Limit	Category	Limiting Facility	Contingency	LCR (MW) (Deficiency)
2028	First Limit	B	None	None	0
2028	First Limit	C	None-binding	Sycamore – Pomerado #1 or #2 69 kV Artesian 230/69 kV bank	0

3.5.10.4.5 Effectiveness factors:

Not needed.

3.5.10.4.6 Alternatives to Reduce or Eliminate Gas Generation

As a part of the 2018-2019 transmission planning process the ISO undertook an assessment in approximately half of the LCR areas and LCR Sub-areas to determine potential transmission alternatives to reduce or eliminate the need for gas-fired generation to meet the LCR requirement.

In the 2018-2019 transmission planning process the Esco LCR Sub-Area was not selected to assess alternatives to reduce or eliminate the requirement for gas-fired generation to address the LCR requirement.

3.5.10.5 **Pala Inner Sub-area**

Pala Inner is Sub-area of the San Diego-Imperial Valley LCR Area.

3.5.10.5.1 Pala Inner LCR Sub-area Diagram

Figure 3.5-94 Pala Inner LCR Sub-area

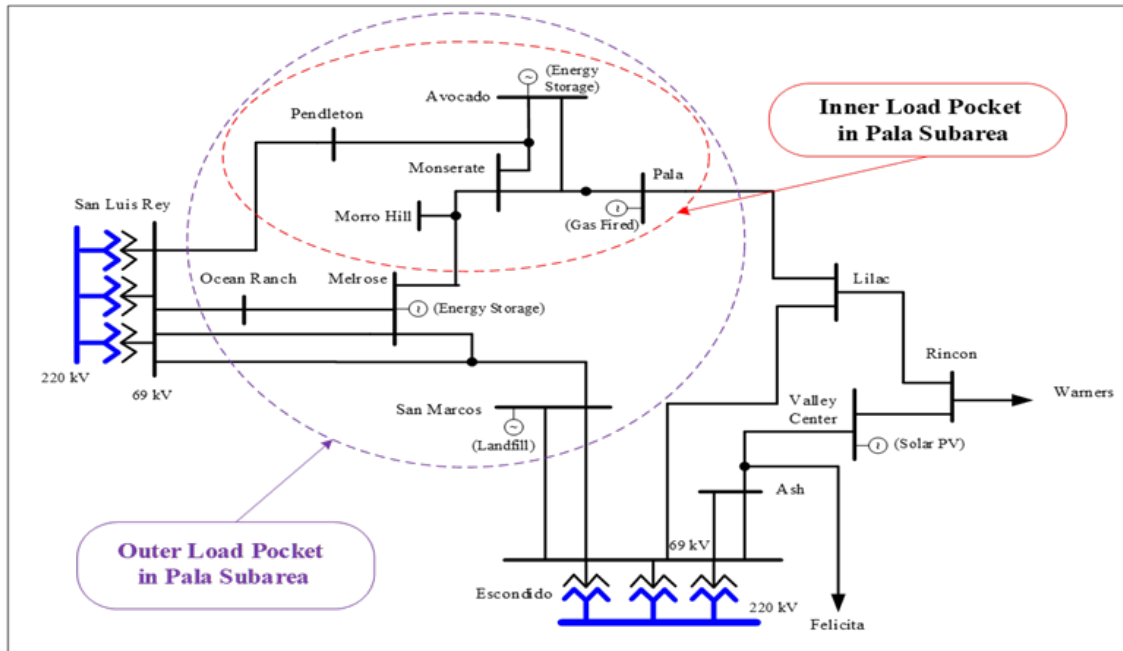

3.5.10.5.2 Pala Inner LCR Sub-area Load and Resources

Table 3.5-99 provides the forecast load and resources in Pala Inner LCR Sub-area in 2028. The list of generators within the LCR Sub-area are provided in Attachment A.

Table 3.5-99 Pala Inner Sub-area 2028 Forecast Load and Resources

Load (MW)		Generation (MW)	
Gross Load	131	Market	100
AAEE	-8	MUNI	0
Behind the meter DG	0	QF	0
Net Load	123	LTPP Preferred Resources	0
Transmission Losses	1	Existing 20-minute Demand Response	0
Pumps	0	Mothballed	0
Load + Losses + Pumps	124	Total Qualifying Capacity	100

3.5.10.5.3 Pala Inner LCR Sub-area Hourly Profiles

Figure 3.5-95 illustrates the forecast 2028 profile for the summer peak day for the Pala Inner LCR Sub-area with the Category C (Multiple Contingency) transmission capability.

Figure 3.5-95 Pala Inner LCR Sub-area 2028 Peak Day Forecast Profiles

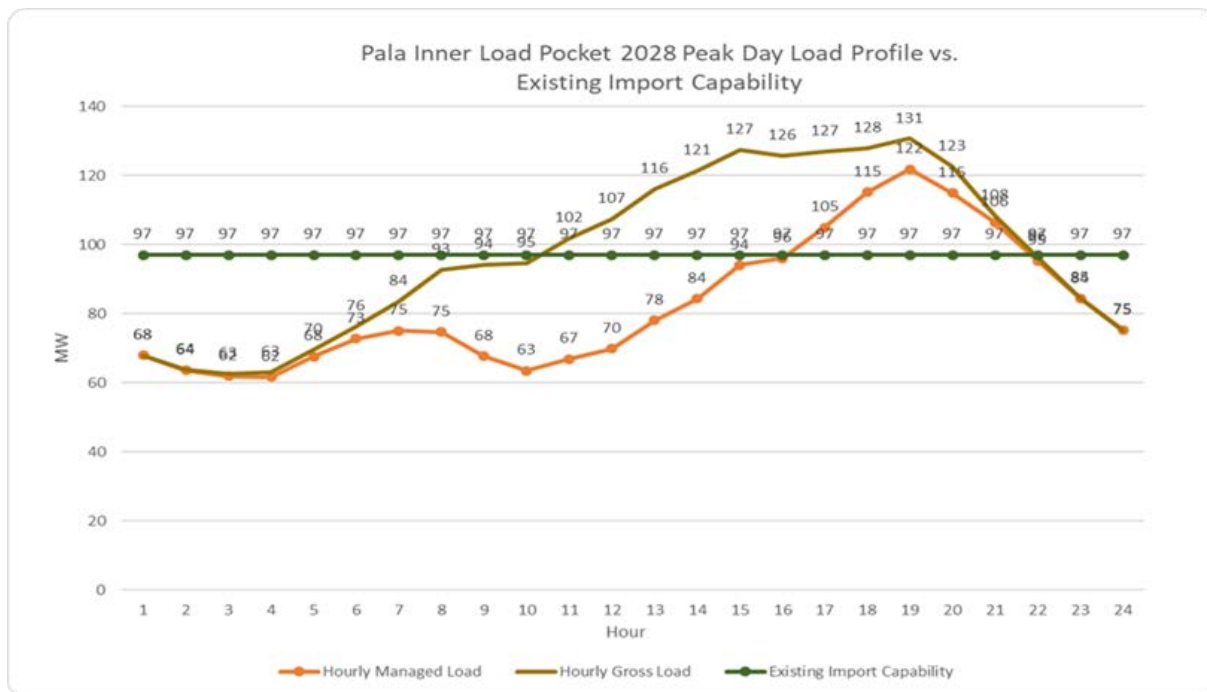

3.5.10.5.4 Pala Inner LCR Sub-area Requirement

Table 3.5-100 identifies the Pala Inner 2028 LCR Sub-area requirements. There is no Category B (Single Contingency) LCR requirement and the LCR requirement for Category C (Multiple Contingency) is 26 MW.

Table 3.5-100 Pala Inner LCR Sub-area Requirements

Year	Limit	Category	Limiting Facility	Contingency	LCR (MW) (Deficiency)
2028	First Limit	B	None	None	0
2028	First Limit	C	Melrose – Morro Hill Tap – Monstrate 69 kV	Pendleton – San Luis Rey 69 kV Lilac – Pala 69 kV	26

3.5.10.5.5 Effectiveness factors:

All units within the Pala Inner Sub-area have the same effectiveness factor.

3.5.10.5.6 Alternatives to Reduce or Eliminate Gas Generation

As a part of the 2018-2019 transmission planning process the ISO undertook an assessment in approximately half of the LCR areas and LCR Sub-areas to determine potential transmission alternatives to reduce or eliminate the need for gas-fired generation to meet the LCR requirement. Alternatives in the Pala Inner Sub-area were assessed. The following alternatives were considered.

- Upgrade Melrose-Morro Hill Tap 69 kV.
- Rely on 40 MW battery storage.

Table 3.5-101 provides the LCR requirement for the alternatives identified above. For the alternatives that reduced the LCR requirement but did not eliminate the requirement, the limiting facility and contingency have been provided.

Table 3.5-101 Alternatives to Reduce or Eliminate the Pala Inner Sub-Area Requirement for Gas-fired generation

Year	Limit	Category	Limiting Facility	Contingency	LCR (MW) (Deficiency)
Upgrade Melrose-Morro Hill Tap 69 kV.					
2028	First limit	C	Same	Same	4
Rely on 40 MW battery storage.					
2028	First limit	C	Same	Same	40

Table 3.5-102 provides the cost estimates and the total Pala Inner LCR Sub-area requirement and portion of requirement that would need to be supplied from gas-fired and non gas generation for the alternatives identified above

Table 3.5-102 Alternative Cost Estimate and LCR Requirement

Alternatives	Submitted By	Estimated Cost (\$M)	Requirement (MW)			
			Total	Market Gas	Other Gas	Non-Gas
Upgrade Melrose-Morro Hill Tap 69 kV.	SDG&E	TBD	4	0	0	4
Rely on 40 MW battery storage.	ISO	TBD	40	0	0	40

3.5.10.6 Pala Outer Sub-area

Pala Outer is Sub-area of the San Diego-Imperial Valley LCR Area.

3.5.10.6.1 Pala Outer LCR Sub-area Diagram

Figure 3.5-96 Pala Outer LCR Sub-area

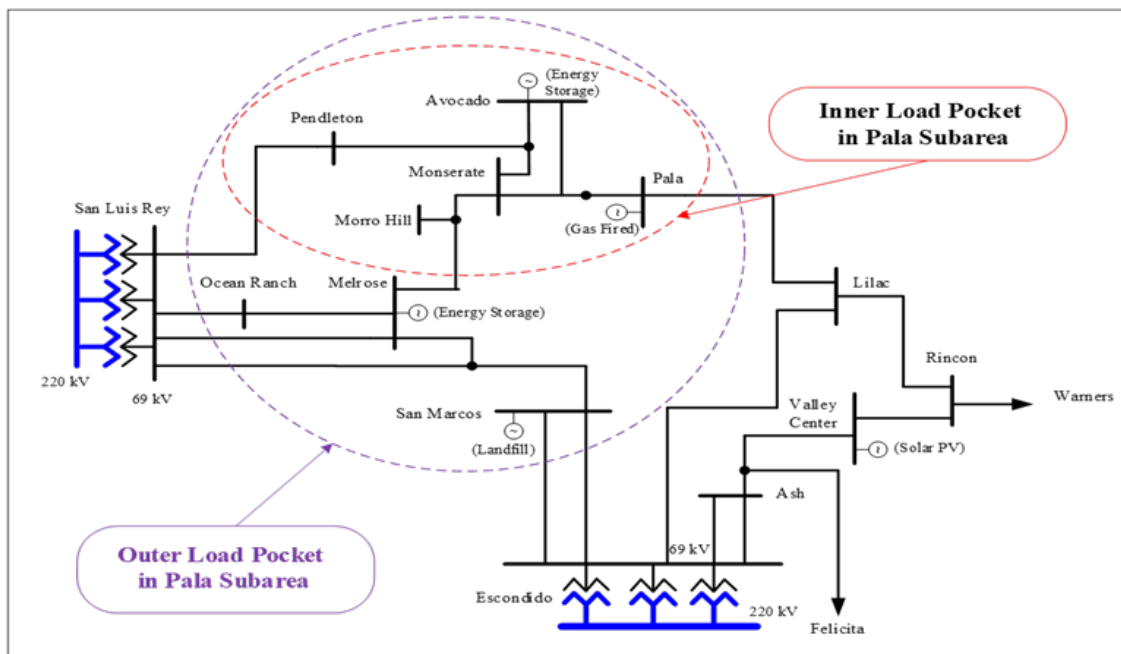

3.5.10.6.2 Pala Outer LCR Sub-area Load and Resources

Table 3.5-103 provides the forecast load and resources in Pala Outer LCR Sub-area in 2028. The list of generators within the LCR Sub-area are provided in Attachment A.

Table 3.5-103 Pala Outer Sub-area 2028 Forecast Load and Resources

Load (MW)		Generation (MW)	
Gross Load	325	Market	140
AAEE	-20	MUNI	0
Behind the meter DG	0	QF	0
Net Load	305	LTPP Preferred Resources	0
Transmission Losses	2	Existing 20-minute Demand Response	0
Pumps	0	Mothballed	0
Load + Losses + Pumps	307	Total Qualifying Capacity	140

3.5.10.6.3 Pala Outer LCR Sub-area Hourly Profiles

Figure 3.5-97 illustrates the forecast 2028 profile for the summer peak day for the Pala Outer LCR Sub-area with the Category C (Multiple Contingency) transmission capability.

Figure 3.5-97 Pala Outer LCR Sub-area 2028 Peak Day Forecast Profiles

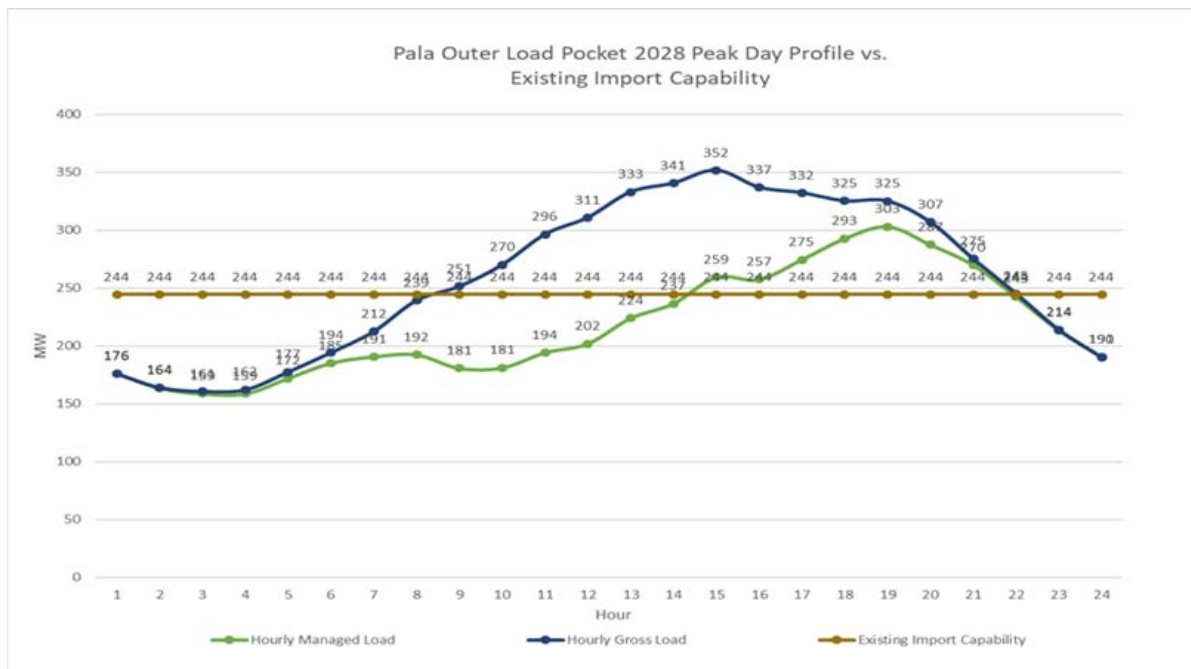

3.5.10.6.4 Pala Outer LCR Sub-area Requirement

Table 3.5-104 identifies the Pala Outer 2028 LCR Sub-area requirements. There is no Category B (Single Contingency) LCR requirement and the LCR requirement for Category C (Multiple Contingency) is 43 MW.

Table 3.5-104 Pala Outer LCR Sub-area Requirements

Year	Limit	Category	Limiting Facility	Contingency	LCR (MW) (Deficiency)
2028	First Limit	B	None	None	0
2028	First Limit	C	San Luis Rey – Ocean Ranch - Melrose 69 kV	San Luis Rey – Melrose 69 kV and San Luis Rey – Melrose -Marcos 69 kV	43

3.5.10.6.5 Effectiveness factors:

All units within the Pala Outer Sub-area have the same effectiveness factor.

3.5.10.6.6 Alternatives to Reduce or Eliminate Gas Generation

As a part of the 2018-2019 transmission planning process the ISO undertook an assessment in approximately half of the LCR areas and LCR Sub-areas to determine potential transmission alternatives to reduce or eliminate the need for gas-fired generation to meet the LCR requirement. Alternatives in the Pala Outer Sub-area were assessed. The following alternatives were considered.

- Rely on 80MW battery storage.

Table 3.5-105 provides the LCR requirement for the alternatives identified above. For the alternatives that reduced the LCR requirement but did not eliminate the requirement, the limiting facility and contingency have been provided.

Table 3.5-105 Alternatives to Reduce or Eliminate the Pala Outer Sub-Area Requirement for Gas-fired generation

Year	Limit	Category	Limiting Facility	Contingency	LCR (MW) (Deficiency)
Rely on 80MW battery storage.					
2028	First limit	C	Same	Same	80

Table 3.5-106 provides the cost estimates and the total Pala Outer LCR Sub-area requirement and portion of requirement that would need to be supplied from gas-fired and non gas generation for the alternatives identified above

Table 3.5-106 Alternative Cost Estimate and LCR Requirement

Alternatives	Submitted By	Estimated Cost (\$M)	Requirement (MW)			
			Total	Market Gas	Other Gas	Non-Gas
Rely on 80MW battery storage.	ISO	TBD	80	0	0	80

3.5.10.7 **Border Sub-area**

Border is Sub-area of the San Diego-Imperial Valley LCR Area.

3.5.10.7.1 **Border LCR Sub-area Diagram**

Figure 3.5-98 Border LCR Sub-area

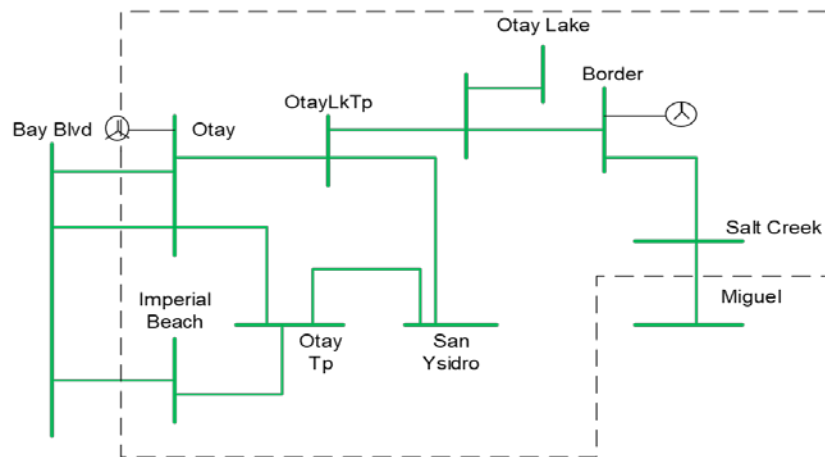

3.5.10.7.2 **Border LCR Sub-area Load and Resources**

Table 3.5-107 provides the forecast load and resources in Border LCR Sub-area in 2028. The list of generators within the LCR Sub-area are provided in Attachment A.

Table 3.5-107 Border Sub-area 2028 Forecast Load and Resources

Load (MW)		Generation (MW)	
Gross Load	175	Market	177
AAEE	-17	MUNI	0
Behind the meter DG	0	QF	2
Net Load	158	LTPP Preferred Resources	0
Transmission Losses	0	Existing 20-minute Demand Response	0
Pumps	0	Mothballed	0
Load + Losses + Pumps	158	Total Qualifying Capacity	179

3.5.10.7.3 Border LCR Sub-area Hourly Profiles

Figure 3.5-99 illustrates the forecast 2028 profile for the summer peak day for the Border LCR Sub-area with the Category C (Multiple Contingency) transmission capability.

Figure 3.5-99 Border LCR Sub-area 2028 Peak Day Forecast Profiles

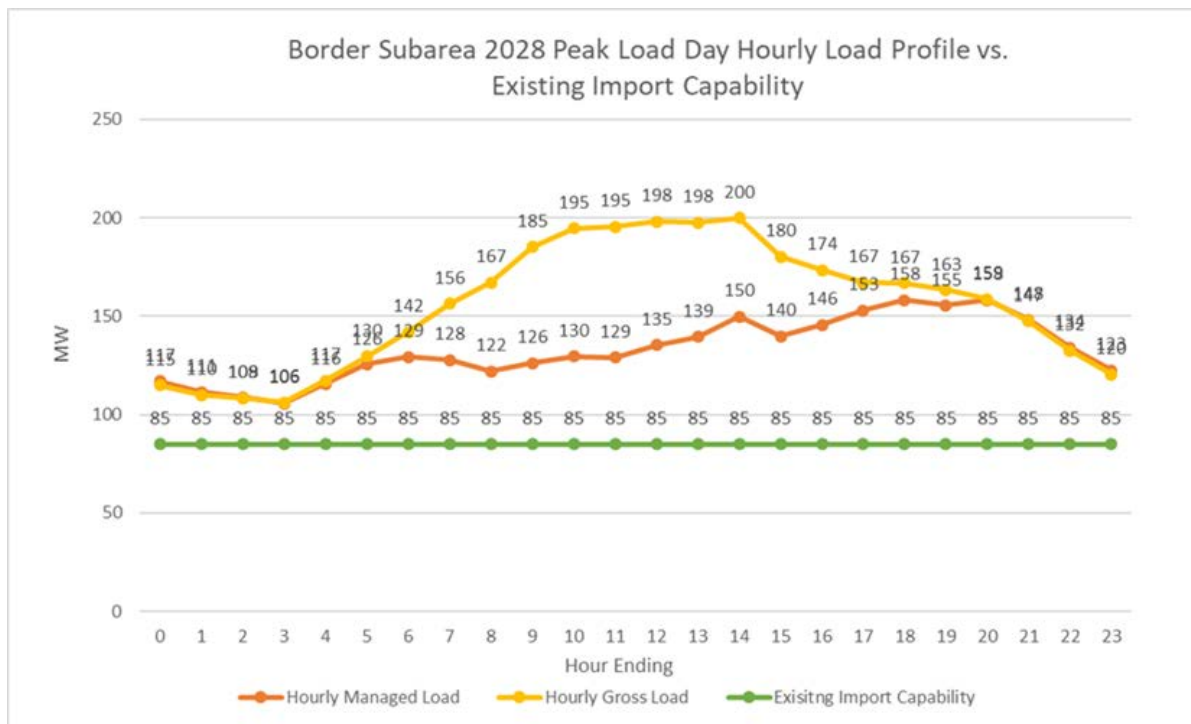

3.5.10.7.4 Border LCR Sub-area Requirement

Table 3.5-108 identifies the Border 2028 LCR Sub-area requirements. There is no Category B (Single Contingency) LCR requirement and the LCR requirement for Category C (Multiple Contingency) is 70 MW. Second limiting contingency is provided for information only.

Table 3.5-108 Border LCR Sub-area Requirements

Year	Limit	Category	Limiting Facility	Contingency	LCR (MW) (Deficiency)
2028	First Limit	B	Otay – Otay Lake Tap 69 kV	Miguel – Salt Creek 69 kV	14
2028	First Limit	C	Imperial Beach – Bay Boulevard 69 kV	Bay Boulevard – Otay #1 69 kV Bay Boulevard – Otay #2 69 kV	70
2028	Second Limit	C	Imperial Beach – Otay Tap 69 kV	Bay Boulevard – Otay #1 69 kV Bay Boulevard – Otay #2 69 kV	18

3.5.10.7.5 Effectiveness factors:

All units within the Border Sub-area have the same effectiveness factor.

3.5.10.7.6 Alternatives to Reduce or Eliminate Gas Generation

As a part of the 2018-2019 transmission planning process the ISO undertook an assessment in approximately half of the LCR areas and LCR Sub-areas to determine potential transmission alternatives to reduce or eliminate the need for gas-fired generation to meet the LCR requirement. Alternatives in the Border Sub-area were assessed. The following alternatives were considered.

- Upgrade Imperial Beach-Bay Boulevard 69 kV and Otay-Otay Lake Tap 69 kV.
- Above plus Upgrade Imperial Beach-Otay Tap 69 kV.

Table 3.5-109 provides the LCR requirement for the alternatives identified above. For the alternatives that reduced the LCR requirement but did not eliminate the requirement, the limiting facility and contingency have been provided.

Table 3.5-109 Alternatives to Reduce or Eliminate the Border Sub-Area Requirement for Gas-fired generation

Year	Limit	Category	Limiting Facility	Contingency	LCR (MW) (Deficiency)
Upgrade Imperial Beach-Bay Boulevard 69 kV and Otay-Otay Lake Tap 69 kV.					
2028	First limit	C	Imperial Beach – Otay Tap 69 kV	Bay Boulevard – Otay #1 69 kV Bay Boulevard – Otay #2 69 kV	18
Above plus Upgrade Imperial Beach-Otay Tap 69 kV.					
2028	First limit	C	None	None	0

Table 3.5-110 provides the cost estimates and the total Border LCR Sub-area requirement and portion of requirement that would need to be supplied from gas-fired and non gas generation for the alternatives identified above

Table 3.5-110 Alternative Cost Estimate and LCR Requirement

Alternatives	Submitted By	Estimated Cost (\$M)	Requirement (MW)			
			Total	Market Gas	Other Gas	Non-Gas
Upgrade Imperial Beach-Bay Boulevard 69 kV and Otay-Otay Lake Tap 69 kV.	SDG&E	\$10-\$16	18	0	0	0
Above plus Upgrade Imperial Beach-Otay Tap 69 kV.	ISO	TBD	0	0	0	0

3.5.10.8 **Miramar Sub-area**

Miramar is a Sub-area of the San Diego-Imperial Valley LCR Area. The 2028 LCT Study identified that the Mission Sub-area will no longer be required due to the Sycamore-Penasquitos 230 kV project being in-service.

3.5.10.9 **San Diego Sub-area**

San Diego is Sub-area of the San Diego-Imperial Valley LCR Area.

3.5.10.9.1 San Diego LCR Sub-area Diagram

Please refer to Figure 3.5-89 above.

3.5.10.9.2 San Diego LCR Sub-area Load and Resources

Table 3.5-111 provides the forecast load and resources in San Diego LCR Sub-area in 2028. The list of generators within the LCR Sub-area are provided in Attachment A.

Table 3.5-111 San Diego Sub-area 2028 Forecast Load and Resources

Load (MW)		Generation (MW)	
Gross Load	5,752	Market	2756
AAEE	-362	MUNI	0
Behind the meter DG	-853	QF	106
Net Load	4,537	LTPP Preferred Resources	24
Transmission Losses	134	Existing 20-minute Demand Response	16
Pumps	0	Mothballed	0
Load + Losses + Pumps	4,671	Total Qualifying Capacity	2902

3.5.10.9.3 San Diego LCR Sub-area Hourly Profiles

Figure 3.5-100 illustrates the forecast 2028 profile for the summer peak day for the San Diego LCR Sub-area.

At SDG&E peak time, SCE load is represented at 97.24% of its own (SCE) peak demand.

Figure 3.5-100 San Diego LCR Sub-area 2028 Peak Day Forecast Profiles

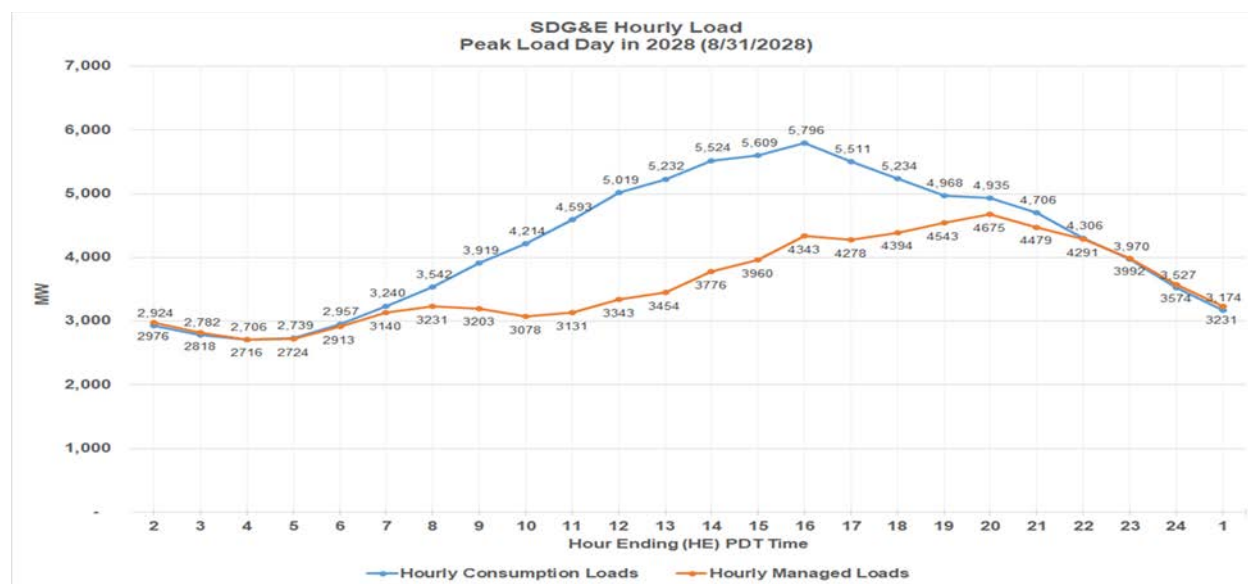

3.5.10.9.4 San Diego LCR Sub-area Requirement

Table 3.5-112 identifies the San Diego 2028 LCR Sub-area requirements. There is no Category B (Single Contingency) LCR requirement and the LCR requirement for Category C (Multiple Contingency) is 2362 MW.

Table 3.5-112 San Diego LCR Sub-area Requirements

Year	Limit	Category	Limiting Facility	Contingency	LCR (MW) (Deficiency)
2028	First Limit	B	None-binding	Multiple combinations possible.	N/A
2028	First Limit	C	Remaining Sycamore – Suncrest 230 kV	Eco – Miguel 500 kV, system readjustment followed by one of the Sycamore – Suncrest 230 kV lines	2,362

3.5.10.9.5 Effectiveness factors:

See Attachment B - Table titled San Diego.

For other helpful procurement information please read procedure 2210Z Effectiveness Factors under 7820 (T-132Z) posted at: <http://www.caiso.com/Documents/2210Z.pdf>

3.5.10.9.6 Alternatives to Reduce or Eliminate Gas Generation

As a part of the 2018-2019 transmission planning process the ISO undertook an assessment in approximately half of the LCR areas and LCR Sub-areas to determine potential transmission alternatives to reduce or eliminate the need for gas-fired generation to meet the LCR requirement. Alternatives in the San Diego Sub-area were assessed. The alternatives are the same as those assessed for the San Diego-Imperial Valley area. For details see discussion in the next section below.

3.5.10.10 San Diego-Imperial Valley Overall**3.5.10.10.1 San Diego-Imperial Valley LCR area Hourly Profiles**

Same as San Diego Sub-area see section above.

3.5.10.10.2 San Diego-Imperial Valley LCR area Requirement

Table 3.5-113 and Table 3.5-114 identify the San Diego-Imperial Valley 2028 LCR area requirements with dispatch at NQC values and output at 8:00 PM respectively. The Category B (Single Contingency) LCR requirement is 3908 MW and the LCR requirement for Category C (Multiple Contingency) is the same.

Table 3.5-113 San Diego-Imperial Valley LCR area Requirements with dispatch at NQC value

Year	Limit	Category	Limiting Facility	Contingency	LCR (MW) (Deficiency)
2028	First Limit	B/C	El Centro 230/92 kV bank	TDM, system readjustment and Imperial Valley – North Gila 500 kV	3,908

Table 3.5-114 San Diego-Imperial Valley LCR area Requirements with dispatch at 8:00 PM

Year	Limit	Category	Limiting Facility	Contingency	LCR (MW) (Deficiency)
2028	First Limit	B/C	El Centro 230/92 kV bank	TDM, system readjustment and Imperial Valley – North Gila 500 kV	3,977

Due to the interaction of the greater LA Basin-San Diego-Imperial Valley area and the fact that San Diego-Imperial Valley has used all available resources it was necessary to increase the requirements in the LA Basin for the case with 8:00 PM hour dispatch.

3.5.10.10.3 Effectiveness factors:

See Attachment B - Table titled San Diego.

For other helpful procurement information please read procedure 2210Z Effectiveness Factors under 7820 (T-132Z) posted at: <http://www.caiso.com/Documents/2210Z.pdf>

3.5.10.10.4 Changes compared to 2023 LCT Study

Compared with the 2023 LCT Study results, the 2028 adjusted peak demand forecast is higher by 136 MW. The overall LCR need for the San Diego – Imperial Valley area has decreased by 224 MW primarily due to more resources materialize in effective area for the limiting constraint In the case of NQC dispatch and used all resources at peak hour dispatch mainly due to effective solar resources not being available.

3.5.10.10.5 Alternatives to Reduce or Eliminate Gas Generation

As a part of the 2018-2019 transmission planning process the ISO undertook an assessment in approximately half of the LCR areas and LCR Sub-areas to determine potential transmission alternatives to reduce or eliminate the need for gas-fired generation to meet the LCR requirement. Alternatives in the San Diego-Imperial Valley area were assessed. The following alternatives were considered.

- Renewable Energy Express HVDC Conversion

- LEAPS (Lake Elsinore Advanced Pump Storage) – Option 2 (highest benefit).
- Alberhill to Sycamore 500 kV plus Miguel to Sycamore loop into Suncrest 230 kV Project.
- San Vincente Energy Storage Facility.
- North Gila-Imperial Valley #2 500 kV line.
- Sycamore 230 kV Energy Storage Project.
- Sycamore Reliability Energy Storage Project.
- Westside Canal Reliability Center (Westside) Project.
- Series reactor on “S-line”,

Table 3.5-115 provides the LCR requirement for the alternatives identified above. For the alternatives that reduced the LCR requirement but did not eliminate the requirement, the limiting facility and contingency have been provided.

Table 3.5-115 Alternatives to Reduce or Eliminate the San Diego-Imperial Valley Area Requirement for Gas-fired generation

Year	Limit	Category	Limiting Facility	Contingency	LCR (MW) (Deficiency)
Renewable Energy Express HVDC Conversion					
2028	First limit	C	Bay Blvd. – Sivergate 230 kV	Miguel – Mission #1 230 kV & Miguel – Mission #2 230 kV	3218
LEAPS (Lake Elsinore Advanced Pump Storage) – Option 2 (Highest benefit)					
2028	First limit	C	Same	Same	3375
Alberhill to Sycamore 500 kV plus Miguel to Sycamore loop into Suncrest 230 kV Project.					
2028	First limit	C	Same	Same	2966
San Vicente Energy Storage Facility.					
2028	First limit	C	Same	Same	3218
North Gila-Imperial Valley #2 500 kV line.					
2028	First limit	C	El Centro 230/92 kV Tx	N. Gila-Imperial Valley #1 500 kV & N. Gila-Imperial Valley #2 500 kV	3043
Sycamore 230 kV Energy Storage Project.					
2028	First limit	C	Same	Same	3678
Sycamore Reliability Energy Storage Project.					
2028	First limit	C	Same	Same	3517
Westside Canal Reliability Center (Westside) Project.					
2028	First limit	C	Same	Same	3478
Series reactor on “S-line”,					
2028	First limit	C	Same	Same	3308

Table 3.5-116 provides the cost estimates and the total San Diego-Imperial Valley LCR area requirement and portion of requirement that would need to be supplied from gas-fired and non gas generation for the alternatives identified above

Table 3.5-116 Alternative Cost Estimate and LCR Requirement

Alternatives	Submitted By	Estimated Cost (\$M)	Requirement (MW)		
			Total	Market Gas Decrease (SD)	Market Gas Increase (LA)
Renewable Energy Express HVDC Conversion	SDG&E	\$1,000-\$2,000	3218	690	40
LEAPS (Lake Elsinore Advanced Pump Storage) Option 2 (Highest benefit).	Nevada Hydro	\$1,760-\$2,040	3375	593	0
Alberhill to Sycamore 500 kV plus Miguel to Sycamore loop into Suncrest 230 kV Project.	PG&E & TransCanyon	\$500-\$750	2966	942	170
San Vicente Energy Storage Facility.	City of San Diego	\$1,500-\$2,000	3218	690	0
North Gila-Imperial Valley #2 500 kV line.	ITC Grid & Southwest TP, LLC	\$250-\$400	3043	865	100
Sycamore 230 kV Energy Storage Project.	NextEra TW	\$200	3678	230	0
Sycamore Reliability Energy Storage Project.	Tenaska	\$108-\$178	3517	391	0
Westside Canal Reliability Center (Westside) Project.	ConEd Renewables	\$304	3478	430	100
Series reactor on "S-line",	ISO	TBD	3308	600	200

3.5.11 Valley Electric Area

Valley Electric Association LCR area has been eliminated on the basis of the following:

- No generation exists in this area
- No category B issues were observed in this area
- Category C and beyond –
 - No common-mode N-2 issues were observed
 - No issues were observed for category B outage followed by a common-mode N-2 outage
 - All the N-1-1 issues that were observed can either be mitigated by the existing UVLS or by an operating procedure

Attachment A – List of physical resources by PTO, local area and market ID

PTO	MKT/SCHED RESOURCE ID	BUS #	BUS NAME	kV	NQC	UNIT ID	LCR AREA NAME	LCR SUB-AREA NAME	NQC Comments	CAISO Tag
PG&E	ALMEGT_1_UNIT 1	38118	ALMDACT1	13.8	23.40	1	Bay Area	Oakland		MUNI
PG&E	ALMEGT_1_UNIT 2	38119	ALMDACT2	13.8	23.50	1	Bay Area	Oakland		MUNI
PG&E	BANKPP_2_NSPIN	38820	DELTA A	13.2	11.55	1	Bay Area	Contra Costa	Pumps	MUNI
PG&E	BANKPP_2_NSPIN	38820	DELTA A	13.2	11.55	2	Bay Area	Contra Costa	Pumps	MUNI
PG&E	BANKPP_2_NSPIN	38820	DELTA A	13.2	11.55	3	Bay Area	Contra Costa	Pumps	MUNI
PG&E	BANKPP_2_NSPIN	38815	DELTA B	13.2	11.55	4	Bay Area	Contra Costa	Pumps	MUNI
PG&E	BANKPP_2_NSPIN	38815	DELTA B	13.2	11.55	5	Bay Area	Contra Costa	Pumps	MUNI
PG&E	BANKPP_2_NSPIN	38770	DELTA C	13.2	11.55	6	Bay Area	Contra Costa	Pumps	MUNI
PG&E	BANKPP_2_NSPIN	38770	DELTA C	13.2	11.55	7	Bay Area	Contra Costa	Pumps	MUNI
PG&E	BANKPP_2_NSPIN	38765	DELTA D	13.2	11.55	8	Bay Area	Contra Costa	Pumps	MUNI
PG&E	BANKPP_2_NSPIN	38765	DELTA D	13.2	11.55	9	Bay Area	Contra Costa	Pumps	MUNI
PG&E	BANKPP_2_NSPIN	38760	DELTA E	13.2	11.55	10	Bay Area	Contra Costa	Pumps	MUNI
PG&E	BANKPP_2_NSPIN	38760	DELTA E	13.2	11.55	11	Bay Area	Contra Costa	Pumps	MUNI
PG&E	BRDSL_2_HIWIND	32172	HIGHWINDS	34.5	42.93	1	Bay Area	Contra Costa	Aug NQC	Wind
PG&E	BRDSL_2_MZUM2	32179	MNTZUMA2	0.69	20.72	1	Bay Area	Contra Costa	Aug NQC	Wind
PG&E	BRDSL_2_MZUMA	32188	HIGHWIND3	0.69	9.75	1	Bay Area	Contra Costa	Aug NQC	Wind
PG&E	BRDSL_2_SHILO1	32176	SHILOH	34.5	39.75	1	Bay Area	Contra Costa	Aug NQC	Wind
PG&E	BRDSL_2_SHILO2	32177	SHILOH 2	34.5	39.75	1	Bay Area	Contra Costa	Aug NQC	Wind
PG&E	BRDSL_2_SHLO3A	32191	SHILOH3	0.58	27.16	1	Bay Area	Contra Costa	Aug NQC	Wind
PG&E	BRDSL_2_SHLO3B	32194	SHILOH4	0.58	26.50	1	Bay Area	Contra Costa	Aug NQC	Wind
PG&E	CALPIN_1_AGNEW	35860	OLS-AGNE	9.11	28.00	1	Bay Area	San Jose, South Bay-Moss Landing	Aug NQC	Market
PG&E	CAYTNO_2_VASCO	30531	0162-WD	230	4.30	FW	Bay Area	Contra Costa	Aug NQC	Market
PG&E	CLRMTK_1_QF				0.00		Bay Area	Oakland	Not modeled	QF/Selfgen
PG&E	COCOPP_2_CTG1	33188	MARSHCT1	16.4	195.90	1	Bay Area	Contra Costa	Aug NQC	Market

Attachment A - List of physical resources by PTO, local area and market ID

PG&E	COCOPP_2_CTG2	33188	MARSHCT2	16.4	195.40	2	Bay Area	Contra Costa	Aug NQC	Market
PG&E	COCOPP_2_CTG3	33189	MARSHCT3	16.4	194.80	3	Bay Area	Contra Costa	Aug NQC	Market
PG&E	COCOPP_2_CTG4	33189	MARSHCT4	16.4	197.55	4	Bay Area	Contra Costa	Aug NQC	Market
PG&E	COCOSB_6_SOLAR				0.00		Bay Area	Contra Costa	Not modeled Energy Only	Market
PG&E	CROKET_7_UNIT	32900	CRCKTCOG	18	231.08	1	Bay Area	Pittsburg	Aug NQC	QF/Selfgen
PG&E	CSCCOG_1_UNIT 1	36859	Laf300	12	3.00	1	Bay Area	San Jose, South Bay-Moss Landing		MUNI
PG&E	CSCCOG_1_UNIT 1	36859	Laf300	12	3.00	2	Bay Area	San Jose, South Bay-Moss Landing		MUNI
PG&E	CSCGNR_1_UNIT 1	36858	Gia100	13.8	24.00	1	Bay Area	San Jose, South Bay-Moss Landing		MUNI
PG&E	CSCGNR_1_UNIT 2	36895	Gia200	13.8	24.00	2	Bay Area	San Jose, South Bay-Moss Landing		MUNI
PG&E	CUMBIA_1_SOLAR	33102	COLUMBIA	0.38	7.79	1	Bay Area	Pittsburg	Aug NQC	Market
PG&E	DELTA_2_PL1X4	33108	DEC CTG1	18	181.13	1	Bay Area	Pittsburg	Aug NQC	Market
PG&E	DELTA_2_PL1X4	33109	DEC CTG2	18	181.13	1	Bay Area	Pittsburg	Aug NQC	Market
PG&E	DELTA_2_PL1X4	33110	DEC CTG3	18	181.13	1	Bay Area	Pittsburg	Aug NQC	Market
PG&E	DELTA_2_PL1X4	33107	DEC STG1	24	269.60	1	Bay Area	Pittsburg	Aug NQC	Market
PG&E	DIXNLD_1_LNDFL				1.30		Bay Area		Not modeled Aug NQC	Market
PG&E	DUANE_1_PL1X3	36865	DVRaST3	13.8	48.36	1	Bay Area	San Jose, South Bay-Moss Landing		MUNI
PG&E	DUANE_1_PL1X3	36863	DVRaGT1	13.8	49.72	1	Bay Area	San Jose, South Bay-Moss Landing		MUNI
PG&E	DUANE_1_PL1X3	36864	DVRbGT2	13.8	49.72	1	Bay Area	San Jose, South Bay-Moss Landing		MUNI
PG&E	GATWAY_2_PL1X3	33119	GATEWAY2	18	177.51	1	Bay Area	Contra Costa	Aug NQC	Market
PG&E	GATWAY_2_PL1X3	33120	GATEWAY3	18	177.51	1	Bay Area	Contra Costa	Aug NQC	Market
PG&E	GATWAY_2_PL1X3	33118	GATEWAY1	18	187.47	1	Bay Area	Contra Costa	Aug NQC	Market
PG&E	GILROY_1_UNIT	35850	GLRY COG	13.8	69.00	1	Bay Area	Llagas, South Bay-Moss Landing	Aug NQC	Market
PG&E	GILROY_1_UNIT	35850	GLRY COG	13.8	36.00	2	Bay Area	Llagas, South Bay-Moss Landing	Aug NQC	Market
PG&E	GILRPP_1_PL1X2	35851	GROYPKR1	13.8	47.70	1	Bay Area	Llagas, South Bay-Moss Landing	Aug NQC	Market

Attachment A - List of physical resources by PTO, local area and market ID

PG&E	GILRPP_1_PL1X2	35852	GROYPKR2	13.8	47.70	1	Bay Area	Llagas, South Bay-Moss Landing	Aug NQC	Market
PG&E	GILRPP_1_PL3X4	35853	GROYPKR3	13.8	46.20	1	Bay Area	Llagas, South Bay-Moss Landing	Aug NQC	Market
PG&E	GRZZLY_1_BERKLY	32741	HILLSIDE_12	12.5	24.57	1	Bay Area	None	Aug NQC	Net Seller
PG&E	KELSO_2_UNITS	33813	MARIPCT1	13.8	49.51	1	Bay Area	Contra Costa	Aug NQC	Market
PG&E	KELSO_2_UNITS	33815	MARIPCT2	13.8	49.51	2	Bay Area	Contra Costa	Aug NQC	Market
PG&E	KELSO_2_UNITS	33817	MARIPCT3	13.8	49.51	3	Bay Area	Contra Costa	Aug NQC	Market
PG&E	KELSO_2_UNITS	33819	MARIPCT4	13.8	49.51	4	Bay Area	Contra Costa	Aug NQC	Market
PG&E	KIRKER_7_KELCYN				3.22		Bay Area	Pittsburg	Not modeled	Market
PG&E	LAWRNC_7_SUNYVL				0.18		Bay Area	None	Not modeled Aug NQC	Market
PG&E	LECEF_1_UNITS	35854	LECEFGT1	13.8	45.97	1	Bay Area	San Jose, South Bay-Moss Landing	Aug NQC	Market
PG&E	LECEF_1_UNITS	35855	LECEFGT2	13.8	45.97	1	Bay Area	San Jose, South Bay-Moss Landing	Aug NQC	Market
PG&E	LECEF_1_UNITS	35856	LECEFGT3	13.8	45.97	1	Bay Area	San Jose, South Bay-Moss Landing	Aug NQC	Market
PG&E	LECEF_1_UNITS	35857	LECEFGT4	13.8	45.97	1	Bay Area	San Jose, South Bay-Moss Landing	Aug NQC	Market
PG&E	LECEF_1_UNITS	35858	LECEFST1	13.8	110.33	1	Bay Area	San Jose, South Bay-Moss Landing		Market
PG&E	LMBEPK_2_UNITA1	32173	LAMBGT1	13.8	48.00	1	Bay Area	Contra Costa	Aug NQC	Market
PG&E	LMBEPK_2_UNITA2	32174	GOOSEHGT	13.8	48.00	2	Bay Area	Contra Costa	Aug NQC	Market
PG&E	LMBEPK_2_UNITA3	32175	CREEDGT1	13.8	48.00	3	Bay Area	Contra Costa	Aug NQC	Market
PG&E	LMEC_1_PL1X3	33111	LMECCT2	18	160.07	1	Bay Area	Pittsburg	Aug NQC	Market
PG&E	LMEC_1_PL1X3	33112	LMECCT1	18	160.07	1	Bay Area	Pittsburg	Aug NQC	Market
PG&E	LMEC_1_PL1X3	33113	LMECST1	18	235.85	1	Bay Area	Pittsburg	Aug NQC	Market
PG&E	MARTIN_1_SUNSET				1.85		Bay Area	None	Not modeled Aug NQC	QF/Selfgen
PG&E	METCLF_1_QF				0.08		Bay Area	None	Not modeled Aug NQC	QF/Selfgen
PG&E	METEC_2_PL1X3	35881	MEC CTG1	18	178.43	1	Bay Area	South Bay-Moss Landing	Aug NQC	Market
PG&E	METEC_2_PL1X3	35882	MEC CTG2	18	178.43	1	Bay Area	South Bay-Moss Landing	Aug NQC	Market

Attachment A - List of physical resources by PTO, local area and market ID

PG&E	METEC_2_PL1X3	35883	MEC STG1	18	213.13	1	Bay Area	South Bay-Moss Landing	Aug NQC	Market
PG&E	MISSIX_1_QF				0.01		Bay Area	None	Not modeled Aug NQC	QF/Selfgen
PG&E	MLPTAS_7_QFUNTS				0.04		Bay Area	San Jose, South Bay-Moss Landing	Not modeled Aug NQC	QF/Selfgen
PG&E	MOSSLD_1_QF				0.00		Bay Area		Not modeled Aug NQC	Market
PG&E	MOSSLD_2_PSP1	36221	DUKMOSS1	18	163.20	1	Bay Area	South Bay-Moss Landing	78% starting 2021	Market
PG&E	MOSSLD_2_PSP1	36222	DUKMOSS2	18	163.20	1	Bay Area	South Bay-Moss Landing	78% starting 2021	Market
PG&E	MOSSLD_2_PSP1	36223	DUKMOSS3	18	183.60	1	Bay Area	South Bay-Moss Landing	78% starting 2021	Market
PG&E	MOSSLD_2_PSP2	36224	DUKMOSS4	18	163.20	1	Bay Area	South Bay-Moss Landing	78% starting 2021	Market
PG&E	MOSSLD_2_PSP2	36225	DUKMOSS5	18	163.20	1	Bay Area	South Bay-Moss Landing	78% starting 2021	Market
PG&E	MOSSLD_2_PSP2	36226	DUKMOSS6	18	183.60	1	Bay Area	South Bay-Moss Landing	78% starting 2021	Market
PG&E	NEWARK_1_QF				0.29		Bay Area	None	Not modeled Aug NQC	QF/Selfgen
PG&E	OAK C_1_EBMUD				1.62		Bay Area	Oakland	Not modeled Aug NQC	MUNI
PG&E	OAK C_7_UNIT 1	32901	OAKLND 1	13.8	55.00	1	Bay Area	Oakland		Market
PG&E	OAK C_7_UNIT 2	32902	OAKLND 2	13.8	55.00	1	Bay Area	Oakland		Market
PG&E	OAK C_7_UNIT 3	32903	OAKLND 3	13.8	55.00	1	Bay Area	Oakland		Market
PG&E	OAK L_1_GTG1				0.00		Bay Area	Oakland	Not modeled Energy Only	Market
PG&E	OXMTN_6_LNDFIL	33469	OX_MTN	4.16	1.45	1	Bay Area	Ames		Market
PG&E	OXMTN_6_LNDFIL	33469	OX_MTN	4.16	1.45	2	Bay Area	Ames		Market
PG&E	OXMTN_6_LNDFIL	33469	OX_MTN	4.16	1.45	3	Bay Area	Ames		Market
PG&E	OXMTN_6_LNDFIL	33469	OX_MTN	4.16	1.45	4	Bay Area	Ames		Market
PG&E	OXMTN_6_LNDFIL	33469	OX_MTN	4.16	1.45	5	Bay Area	Ames		Market
PG&E	OXMTN_6_LNDFIL	33469	OX_MTN	4.16	1.45	6	Bay Area	Ames		Market
PG&E	OXMTN_6_LNDFIL	33469	OX_MTN	4.16	1.45	7	Bay Area	Ames		Market
PG&E	PALALT_7_COBUG				4.50		Bay Area	None	Not modeled	MUNI

Attachment A - List of physical resources by PTO, local area and market ID

PG&E	RICHMN_1_CHVSR2				3.48		Bay Area	None	Not modeled Aug NQC	Market
PG&E	RICHMN_1_SOLAR				0.82		Bay Area	None	Not modeled Aug NQC	Market
PG&E	RICHMN_7_BAYENV				2.00		Bay Area	None	Not modeled Aug NQC	Market
PG&E	RUSCTY_2_UNITS	35304	RUSELECT1	15	186.97	1	Bay Area	Ames	No NQC - Pmax	Market
PG&E	RUSCTY_2_UNITS	35305	RUSELECT2	15	186.97	2	Bay Area	Ames	No NQC - Pmax	Market
PG&E	RUSCTY_2_UNITS	35306	RUSELST1	15	246.06	3	Bay Area	Ames	No NQC - Pmax	Market
PG&E	RVRVEW_1_UNITA1	33178	RVEC_GEN	13.8	48.70	1	Bay Area	Contra Costa	Aug NQC	Market
PG&E	SRINTL_6_UNIT	33468	SRI INTL	9.11	0.34	1	Bay Area	None	Aug NQC	QF/Selfgen
PG&E	STAUFF_1_UNIT	33139	STAUFER	9.11	0.02	1	Bay Area	None	Aug NQC	QF/Selfgen
PG&E	STOILS_1_UNITS	32921	CHEVGEN1	13.8	1.22	1	Bay Area	Pittsburg	Aug NQC	Market
PG&E	STOILS_1_UNITS	32922	CHEVGEN2	13.8	1.22	1	Bay Area	Pittsburg	Aug NQC	Market
PG&E	STOILS_1_UNITS	32923	CHEVGEN3	13.8	0.57	3	Bay Area	Pittsburg	Aug NQC	Market
PG&E	TIDWTR_2_UNITS	33151	FOSTER W	12.5	3.57	1	Bay Area	Pittsburg	Aug NQC	Net Seller
PG&E	TIDWTR_2_UNITS	33151	FOSTER W	12.5	3.57	2	Bay Area	Pittsburg	Aug NQC	Net Seller
PG&E	TIDWTR_2_UNITS	33151	FOSTER W	12.5	2.71	3	Bay Area	Pittsburg	Aug NQC	Net Seller
PG&E	UNCHEM_1_UNIT	32920	UNION CH	9.11	11.07	1	Bay Area	Pittsburg	Aug NQC	QF/Selfgen
PG&E	UNOCAL_1_UNITS	32910	UNOCAL	12	0.25	1	Bay Area	Pittsburg	Aug NQC	QF/Selfgen
PG&E	UNOCAL_1_UNITS	32910	UNOCAL	12	0.25	2	Bay Area	Pittsburg	Aug NQC	QF/Selfgen
PG&E	UNOCAL_1_UNITS	32910	UNOCAL	12	0.25	3	Bay Area	Pittsburg	Aug NQC	QF/Selfgen
PG&E	USWNRD_2_SMUD	32169	SOLANOWP	21	27.08	1	Bay Area	Contra Costa	Aug NQC	Wind
PG&E	USWNRD_2_SMUD2	32186	SOLANO	34. 5	33.87	1	Bay Area	Contra Costa	Aug NQC	Wind
PG&E	USWNRD_2_UNITS	32168	EXNCO	9.11	15.79	1	Bay Area	Contra Costa	Aug NQC	Wind
PG&E	USWPJR_2_UNITS	39233	GRNRDG	0.69	20.72	1	Bay Area	Contra Costa	Aug NQC	Wind
PG&E	WNDMAS_2_UNIT 1	33170	WINDMSTR	9.11	10.07	1	Bay Area	Contra Costa	Aug NQC	Wind
PG&E	ZOND_6_UNIT	35316	ZOND SYS	9.11	4.53	1	Bay Area	Contra Costa	Aug NQC	Wind
PG&E	ZZ_IBMCTL_1_UNIT 1	35637	IBM-CTLE	115	0.00	1	Bay Area	San Jose, South Bay-Moss Landing	No NQC - hist. data	Market
PG&E	ZZ_IMHOFF_1_UNIT 1	33136	CCCSD	12.5	0.00	1	Bay Area	Pittsburg	No NQC - hist. data	QF/Selfgen

Attachment A - List of physical resources by PTO, local area and market ID

PG&E	ZZ_LFC 51_2_UNIT 1	35310	PPASSWND	21	0.00	1	Bay Area	None	No NQC - est. data	Wind
PG&E	ZZ_MARKHM_1_CATLST	35863	CATALYST	9.11	0.00	1	Bay Area	San Jose, South Bay-Moss Landing		QF/Selfgen
PG&E	ZZ_NA	36209	SLD ENRG	12.5	0.00	1	Bay Area	South Bay-Moss Landing		QF/Selfgen
PG&E	ZZ_NA	35861	SJ-SCL W	4.3	0.00	1	Bay Area	San Jose, South Bay-Moss Landing	No NQC - hist. data	QF/Selfgen
PG&E	ZZ_SEAWST_6_LAPOS	35312	FOREBAYW	22	0.00	1	Bay Area	Contra Costa	No NQC - est. data	Wind
PG&E	ZZ_SHELRF_1_UNITS	33141	SHELL 1	12.5	0.00	1	Bay Area	Pittsburg	No NQC - hist. data	Net Seller
PG&E	ZZ_SHELRF_1_UNITS	33142	SHELL 2	12.5	0.00	1	Bay Area	Pittsburg	No NQC - hist. data	Net Seller
PG&E	ZZ_SHELRF_1_UNITS	33143	SHELL 3	12.5	0.00	1	Bay Area	Pittsburg	No NQC - hist. data	Net Seller
PG&E	ZZ_USWPFK_6_FRICK	35320	FRICKWND	12	1.90	1	Bay Area	Contra Costa	Aug NQC	Wind
PG&E	ZZ_USWPFK_6_FRICK	35320	FRICKWND	12	0.00	2	Bay Area	Contra Costa	Aug NQC	Wind
PG&E	ZZ_ZANKER_1_UNIT 1	35861	SJ-SCL W	4.3	0.00	RN	Bay Area	San Jose, South Bay-Moss Landing	No NQC - hist. data	QF/Selfgen
PG&E	ZZZ_New Unit	35623	SWIFT	21	4.00	BT	Bay Area	South Bay-Moss Landing	No NQC - Pmax	Battery
PG&E	ZZZ_New Unit	30522	0354-WD	21	1.83	EW	Bay Area	Contra Costa	No NQC - Pmax	Market
PG&E	ZZZ_New Unit	35302	NUMMI-LV	12.6	0.00	RN	Bay Area		Energy Only	Market
PG&E	ZZZ_New Unit	35859	HGST-LV	12.4	0.00	RN	Bay Area		Energy Only	Market
PG&E	ZZZ_New Unit	35307	A100US-L	12.6	0.00	RN	Bay Area		Energy Only	Market
PG&E	ZZZZZZ_COCOPP_7_UNIT 6	33116	C.COS 6	18	0.00	RT	Bay Area	Contra Costa	Retired	Market
PG&E	ZZZZZZ_COCOPP_7_UNIT 7	33117	C.COS 7	18	0.00	RT	Bay Area	Contra Costa	Retired	Market
PG&E	ZZZZZZ_CONTAN_1_UNIT	36856	CCA100	13.8	0.00	1	Bay Area	San Jose, South Bay-Moss Landing	Retired	MUNI
PG&E	ZZZZZZ_FLOWD1_6_ALT PP1	35318	FLOWDPTR	9.11	0.00	1	Bay Area	Contra Costa	Retired	Wind
PG&E	ZZZZZZ_MOSSLD_7_UNIT 6	36405	MOSSLND6	22	0.00	1	Bay Area	South Bay-Moss Landing	Retired	Market

Attachment A - List of physical resources by PTO, local area and market ID

PG&E	ZZZZZ_MOSSLD_7_UNIT 7	36406	MOSSLND7	22	0.00	1	Bay Area	South Bay-Moss Landing	Retired	Market
PG&E	ZZZZZ_PITTSP_7_UNIT 5	33105	PTSB 5	18	0.00	RT	Bay Area	Pittsburg	Retired	Market
PG&E	ZZZZZ_PITTSP_7_UNIT 6	33106	PTSB 6	18	0.00	RT	Bay Area	Pittsburg	Retired	Market
PG&E	ZZZZZ_PITTSP_7_UNIT 7	30000	PTSB 7	20	0.00	RT	Bay Area	Pittsburg	Retired	Market
PG&E	ZZZZZ_UNTDQF_7_UNITS	33466	UNTED CO	9.11	0.00	1	Bay Area	None	Retired	QF/Selfgen
PG&E	ADERA_1_SOLAR1	34319	Q644	0.48	0.00	1	Fresno	Wilson, Herndon	Aug NQC	Market
PG&E	ADMEST_6_SOLAR	34315	ADAMS_E	12.5	0.00	1	Fresno	Wilson, Herndon	Energy Only	Market
PG&E	AGRICO_6_PL3N5	34608	AGRICO	13.8	22.69	3	Fresno	Wilson, Herndon		Market
PG&E	AGRICO_7_UNIT	34608	AGRICO	13.8	7.47	2	Fresno	Wilson, Herndon		Market
PG&E	AGRICO_7_UNIT	34608	AGRICO	13.8	43.13	4	Fresno	Wilson, Herndon		Market
PG&E	AVENAL_6_AVPARK	34265	AVENAL P	12	0.00	1	Fresno	Wilson, Coalinga	Energy Only	Market
PG&E	AVENAL_6_AVSLR1	34691	AVENAL_1		0.00	EW	Fresno	Wilson, Coalinga	Not modeled Energy Only	Market
PG&E	AVENAL_6_AVSLR2	34691	AVENAL_1		0.00	EW	Fresno	Wilson, Coalinga	Not modeled Energy Only	Market
PG&E	AVENAL_6_SANDDG	34263	SANDDRAG	12	0.00	1	Fresno	Wilson, Coalinga	Energy Only	Market
PG&E	AVENAL_6_SUNCTY	34257	SUNCTY D	12	0.00	1	Fresno	Wilson, Coalinga	Energy Only	Market
PG&E	BALCHS_7_UNIT 1	34624	BALCH	13.2	33.00	1	Fresno	Wilson, Herndon, Reedley	Aug NQC	Market
PG&E	BALCHS_7_UNIT 2	34612	BLCH	13.8	52.50	1	Fresno	Wilson, Herndon	Aug NQC	Market
PG&E	BALCHS_7_UNIT 3	34614	BLCH	13.8	52.50	1	Fresno	Wilson, Herndon	Aug NQC	Market
PG&E	CANTUA_1_SOLAR	34349	CANTUA_D	12.5	4.10	1	Fresno	Wilson	Aug NQC	Market
PG&E	CANTUA_1_SOLAR	34349	CANTUA_D	12.5	4.10	2	Fresno	Wilson	Aug NQC	Market
PG&E	CAPMAD_1_UNIT 1	34179	MADERA_G	13.8	4.29	1	Fresno	Wilson		Market
PG&E	CHEVCO_6_UNIT 1	34652	CHV.COAL	9.11	1.70	1	Fresno	Wilson, Coalinga	Aug NQC	QF/Selfgen
PG&E	CHEVCO_6_UNIT 2	34652	CHV.COAL	9.11	0.93	2	Fresno	Wilson, Coalinga	Aug NQC	QF/Selfgen
PG&E	CHWCHL_1_BIOMAS	34305	CHWCHLA2	13.8	9.78	1	Fresno	Wilson, Herndon	Aug NQC	Market
PG&E	CHWCHL_1_UNIT	34301	CHOWCOGN	13.8	48.00	1	Fresno	Wilson, Herndon		Market
PG&E	COLGA1_6_SHELLW	34654	COLNGAGN	9.11	34.70	1	Fresno	Wilson, Coalinga	Aug NQC	Net Seller
PG&E	CORCAN_1_SOLAR1				8.20		Fresno	Wilson, Herndon, Hanford	Not Modeled Aug NQC	Market

Attachment A - List of physical resources by PTO, local area and market ID

PG&E	CORCAN_1_SOLAR2				4.51		Fresno	Wilson, Herndon, Hanford	Not Modeled Aug NQC	Market
PG&E	CRESSY_1_PARKER	34140	CRESSEY	115	0.73		Fresno	Wilson	Not modeled Aug NQC	MUNI
PG&E	CRNEVL_6_CRNVA	34634	CRANEVLY	12	0.90	1	Fresno	Wilson, Borden	Aug NQC	Market
PG&E	CRNEVL_6_SJQN 2	34631	SJ2GEN	9.11	3.20	1	Fresno	Wilson, Borden	Aug NQC	Market
PG&E	CRNEVL_6_SJQN 3	34633	SJ3GEN	9.11	4.20	1	Fresno	Wilson, Borden	Aug NQC	Market
PG&E	CURTIS_1_CANLCK				0.13		Fresno	Wilson	Not modeled Aug NQC	Market
PG&E	CURTIS_1_FARFLD				0.30		Fresno	Wilson	Not modeled Aug NQC	Market
PG&E	DINUBA_6_UNIT	34648	DINUBA E	13.8	3.93	1	Fresno	Wilson, Herndon, Reedley		Market
PG&E	EEKTMN_6_SOLAR1	34627	KETTLEMN	0.34	0.00	1	Fresno	Wilson	Energy Only	Market
PG&E	ELCAP_1_SOLAR				0.62		Fresno	Wilson	Not Modeled Aug NQC	Market
PG&E	ELNIDP_6_BIOMAS	34330	ELNIDO	13.8	9.40	1	Fresno	Wilson	Aug NQC	Market
PG&E	EXCHEC_7_UNIT 1	34306	EXCHQUER	13.8	90.72	1	Fresno	Wilson	Aug NQC	MUNI
PG&E	EXCLSG_1_SOLAR	34623	Q678	0.5	24.60	1	Fresno	Wilson	Aug NQC	Market
PG&E	FRESHW_1_SOLAR1	34669	Q529A	4.16	0.00	1	Fresno	Wilson, Herndon	Energy Only	Market
PG&E	FRESHW_1_SOLAR1	34669	Q529A	0.48	0.00	2	Fresno	Wilson, Herndon	Energy Only	Market
PG&E	FRIANT_6_UNITS	34636	FRIANTDM	6.6	5.76	2	Fresno	Wilson, Borden	Aug NQC	Net Seller
PG&E	FRIANT_6_UNITS	34636	FRIANTDM	6.6	3.08	3	Fresno	Wilson, Borden	Aug NQC	Net Seller
PG&E	FRIANT_6_UNITS	34636	FRIANTDM	6.6	0.81	4	Fresno	Wilson, Borden	Aug NQC	Net Seller
PG&E	GIFENS_6_BUGSL1	34644	Q679	0.55	8.20	1	Fresno	Wilson	Aug NQC	Market
PG&E	GIFFEN_6_SOLAR				4.10		Fresno	Wilson	Not modeled Aug NQC	Market
PG&E	GUERNS_6_SOLAR	34461	GUERNSEY	12.5	4.10	1	Fresno	Wilson	Aug NQC	Market
PG&E	GUERNS_6_SOLAR	34461	GUERNSEY	12.5	4.10	2	Fresno	Wilson	Aug NQC	Market
PG&E	GWFPWR_1_UNITS	34431	GWF_HEP1	13.8	49.23	1	Fresno	Wilson, Herndon, Hanford		Market
PG&E	GWFPWR_1_UNITS	34433	GWF_HEP2	13.8	49.23	1	Fresno	Wilson, Herndon, Hanford		Market
PG&E	HAASPH_7_PL1X2	34610	HAAS	13.8	72.00	1	Fresno	Wilson, Herndon	Aug NQC	Market
PG&E	HAASPH_7_PL1X2	34610	HAAS	13.8	72.00	2	Fresno	Wilson, Herndon	Aug NQC	Market
PG&E	HELMPG_7_UNIT 1	34600	HELMS	18	407.00	1	Fresno	Wilson	Aug NQC	Market

Attachment A - List of physical resources by PTO, local area and market ID

PG&E	HELMPG_7_UNIT 2	34602	HELMS	18	407.00	2	Fresno	Wilson	Aug NQC	Market
PG&E	HELMPG_7_UNIT 3	34604	HELMS	18	404.00	3	Fresno	Wilson	Aug NQC	Market
PG&E	HENRTA_6_SOLAR1				0.00		Fresno	Wilson	Not modeled Energy Only	Market
PG&E	HENRTA_6_SOLAR2				0.00		Fresno	Wilson	Not modeled Energy Only	Market
PG&E	HENRTA_6_UNITA1	34539	GWF_GT1	13.8	49.98	1	Fresno	Wilson		Market
PG&E	HENRTA_6_UNITA2	34541	GWF_GT2	13.8	49.42	1	Fresno	Wilson		Market
PG&E	HENRTS_1_SOLAR	34617	Q581	0.38	41.00	1	Fresno	Wilson, Hanford	Aug NQC	Market
PG&E	HURON_6_SOLAR	34557	HURON_DI	12.5	4.10	1	Fresno	Wilson, Coalinga	Aug NQC	Market
PG&E	HURON_6_SOLAR	34557	HURON_DI	12.5	4.10	2	Fresno	Wilson, Coalinga	Aug NQC	Market
PG&E	INTTRB_6_UNIT	34342	INT.TURB	9.11	5.63	1	Fresno	Wilson	Aug NQC	Market
PG&E	JAYNE_6_WLSLR	34639	WESTLNDS	0.48	0.00	1	Fresno	Wilson, Coalinga	Energy Only	Market
PG&E	KANSAS_6_SOLAR	34666	KANSASS_S	12.5	0.00	F	Fresno	Wilson	Energy Only	Market
PG&E	KERKH1_7_UNIT 1	34344	KERCK1-1	6.6	13.00	1	Fresno	Wilson, Herndon	Aug NQC	Market
PG&E	KERKH1_7_UNIT 3	34345	KERCK1-3	6.6	12.80	3	Fresno	Wilson, Herndon	Aug NQC	Market
PG&E	KERKH2_7_UNIT 1	34308	KERCKHOF	13.8	153.90	1	Fresno	Wilson, Herndon	Aug NQC	Market
PG&E	KERMAN_6_SOLAR1				0.00		Fresno	Wilson	Not modeled Energy Only	Market
PG&E	KERMAN_6_SOLAR2				0.00		Fresno	Wilson	Not modeled Energy Only	Market
PG&E	KINGCO_1_KINGBR	34642	KINGSBUR	9.11	34.50	1	Fresno	Wilson, Herndon, Hanford	Aug NQC	Net Seller
PG&E	KINGRV_7_UNIT 1	34616	KINGSRIV	13.8	51.20	1	Fresno	Wilson, Herndon, Reedley	Aug NQC	Market
PG&E	KNGBRG_1_KBSLR1				0.00		Fresno	Wilson	Not modeled Energy Only	Market
PG&E	KNGBRG_1_KBSLR2				0.00		Fresno	Wilson	Not modeled Energy Only	Market
PG&E	KNTSTH_6_SOLAR	34694	KENT_S	0.8	0.00	1	Fresno	Wilson	Energy Only	Market
PG&E	LEPRFD_1_KANSAS	34680	KANSAS	12.5	8.20	1	Fresno	Wilson, Hanford	Aug NQC	Market
PG&E	MALAGA_1_PL1X2	34671	KRCDPCT1	13.8	48.00	1	Fresno	Wilson, Herndon		Market
PG&E	MALAGA_1_PL1X2	34672	KRCDPCT2	13.8	48.00	1	Fresno	Wilson, Herndon		Market
PG&E	MCCALL_1_QF	34219	MCCALL 4	12.5	0.44	QF	Fresno	Wilson, Herndon	Aug NQC	QF/Selfgen
PG&E	MCSWAN_6_UNITS	34320	MCSWAIN	9.11	9.60	1	Fresno	Wilson	Aug NQC	MUNI
PG&E	MENBIO_6_RENEW1	34339	CALRENEW	12.5	2.05	1	Fresno	Wilson, Herndon	Aug NQC	Net Seller

Attachment A - List of physical resources by PTO, local area and market ID

PG&E	MENBIO_6_UNIT	34334	BIO PWR	9.11	19.24	1	Fresno	Wilson	Aug NQC	QF/Selfgen
PG&E	MERCED_1_SOLAR1				0.00		Fresno	Wilson	Not modeled Energy Only	Market
PG&E	MERCED_1_SOLAR2				0.00		Fresno	Wilson	Not modeled Energy Only	Market
PG&E	MERCFL_6_UNIT	34322	MERCEDFL	9.11	3.36	1	Fresno	Wilson	Aug NQC	Market
PG&E	MNDOTA_1_SOLAR1	34311	NORTHSTAR	0.2	24.60	1	Fresno	Wilson	Aug NQC	Market
PG&E	MNDOTA_1_SOLAR2				0.00		Fresno	Wilson	Not modeled Energy Only	Market
PG&E	MSTANG_2_SOLAR	34683	Q643W	0.8	12.30	1	Fresno	Wilson	Aug NQC	Market
PG&E	MSTANG_2_SOLAR3	34683	Q643W	0.8	16.40	1	Fresno	Wilson	Aug NQC	Market
PG&E	MSTANG_2_SOLAR4	34683	Q643W	0.8	12.30	1	Fresno	Wilson	Aug NQC	Market
PG&E	ONLLPP_6_UNITS	34316	ONEILPMP	9.11	0.37	1	Fresno	Wilson	Aug NQC	MUNI
PG&E	OROLOM_1_SOLAR1				0.00		Fresno	Wilson	Not modeled Energy Only	Market
PG&E	OROLOM_1_SOLAR2				0.00		Fresno	Wilson	Not modeled Energy Only	Market
PG&E	PAIGES_6_SOLAR				0.00		Fresno	Wilson	Not modeled Energy Only	Market
PG&E	PINFLT_7_UNITS	38720	PINEFLAT	13.8	70.00	1	Fresno	Wilson, Herndon	Aug NQC	MUNI
PG&E	PINFLT_7_UNITS	38720	PINEFLAT	13.8	70.00	2	Fresno	Wilson, Herndon	Aug NQC	MUNI
PG&E	PINFLT_7_UNITS	38720	PINEFLAT	13.8	70.00	3	Fresno	Wilson, Herndon	Aug NQC	MUNI
PG&E	PNCHPP_1_PL1X2	34328	STARGT1	13.8	59.96	1	Fresno	Wilson		Market
PG&E	PNCHPP_1_PL1X2	34329	STARGT2	13.8	59.96	2	Fresno	Wilson		Market
PG&E	PNOCHE_1_PL1X2	34142	WHD_PAN2	13.8	49.97	1	Fresno	Wilson, Herndon		Market
PG&E	PNOCHE_1_UNITA1	34186	DG_PAN1	13.8	48.00	1	Fresno	Wilson		Market
PG&E	REEDLY_6_SOLAR				0.00		Fresno	Wilson, Herndon, Reedley	Not modeled Energy Only	Market
PG&E	S_RITA_6_SOLAR1				0.00		Fresno	Wilson	Not modeled Energy Only	Market
PG&E	SCHNDR_1_FIVPTS	34353	SCHINDLER_D	12.5	4.10	1	Fresno	Wilson	Aug NQC	Market
PG&E	SCHNDR_1_FIVPTS	34353	SCHINDLER_D	12.5	2.05	2	Fresno	Wilson	Aug NQC	Market
PG&E	SCHNDR_1_WSTSDE	34353	SCHINDLER_D	12.5	4.10	3	Fresno	Wilson	Aug NQC	Market

Attachment A - List of physical resources by PTO, local area and market ID

PG&E	SCHNDR_1_WSTSDE	34353	SCHINDLER_D	12.5	2.05	4	Fresno	Wilson	Aug NQC	Market
PG&E	SGREGY_6_SANGER	34646	SANGERCO	13.8	38.77	1	Fresno	Wilson, Reedley	Aug NQC	Market
PG&E	SGREGY_6_SANGER	34646	SANGERCO	13.8	9.31	2	Fresno	Wilson, Reedley	Aug NQC	Market
PG&E	STOREY_2_MDRCH2	34253	BORDEN D	12.5	0.21	QF	Fresno	Wilson	Not modeled Aug NQC	Market
PG&E	STOREY_2_MDRCH3	34253	BORDEN D	12.5	0.18	QF	Fresno	Wilson	Not modeled Aug NQC	Market
PG&E	STOREY_2_MDRCH4	34253	BORDEN D	12.5	0.27	QF	Fresno	Wilson	Not modeled Aug NQC	Market
PG&E	STOREY_7_MDRCHW	34209	STOREY D	12.5	0.21	1	Fresno	Wilson	Aug NQC	Net Seller
PG&E	STROUD_6_SOLAR	34563	STROUD_D	12.5	4.10	1	Fresno	Wilson, Herndon	Aug NQC	Market
PG&E	STROUD_6_SOLAR	34563	STROUD_D	12.5	4.10	2	Fresno	Wilson, Herndon	Aug NQC	Market
PG&E	TRNQL8_2_AZUSR1	365517	Q1032G2	0.55	8.20	2	Fresno	Wilson	Aug NQC	Market
PG&E	TRNQLT_2_SOLAR	34340	Q643X	0.8	82.00	1	Fresno	Wilson	Aug NQC	Market
PG&E	ULTPFR_1_UNIT 1	34640	ULTR.PWR	9.11	24.07	1	Fresno	Wilson, Herndon	Aug NQC	Market
PG&E	VEGA_6_SOLAR1	34314	VEGA	34.5	0.00	1	Fresno	Wilson	Energy Only	Market
PG&E	WAUKNA_1_SOLAR	34696	CORCORANP V_S	21	8.20	1	Fresno	Wilson, Herndon, Hanford	Aug NQC	Market
PG&E	WAUKNA_1_SOLAR2	34677	Q558	21	8.10	1	Fresno	Wilson, Herndon, Hanford	No NQC - Pmax	Market
PG&E	WFRESN_1_SOLAR				0.00		Fresno	Wilson	Not modeled Energy Only	Market
PG&E	WHITNY_6_SOLAR	34673	Q532	0.55	0.00	1	Fresno	Wilson, Coalinga	Energy Only	Market
PG&E	WISHON_6_UNITS	34658	WISHON	2.3	4.51	1	Fresno	Wilson, Borden	Aug NQC	Market
PG&E	WISHON_6_UNITS	34658	WISHON	2.3	4.51	2	Fresno	Wilson, Borden	Aug NQC	Market
PG&E	WISHON_6_UNITS	34658	WISHON	2.3	4.51	3	Fresno	Wilson, Borden	Aug NQC	Market
PG&E	WISHON_6_UNITS	34658	WISHON	2.3	4.51	4	Fresno	Wilson, Borden	Aug NQC	Market
PG&E	WISHON_6_UNITS	34658	WISHON	2.3	0.36	SJ	Fresno	Wilson, Borden	Aug NQC	Market
PG&E	WOODWR_1_HYDRO				0.00		Fresno	Wilson	Not modeled Energy Only	Market
PG&E	WRGHTP_7_AMENGY	34207	WRIGHT D	12.5	0.03	QF	Fresno	Wilson	Aug NQC	QF/Selfgen
PG&E	ZZ_BORDEN_2_QF	34253	BORDEN D	12.5	1.30	QF	Fresno	Wilson	No NQC - hist. data	Net Seller
PG&E	ZZ_BULLRD_7_SAGNES	34213	BULLD 12	12.5	0.06	1	Fresno	Wilson	Aug NQC	QF/Selfgen

Attachment A - List of physical resources by PTO, local area and market ID

PG&E	ZZ_GATES_6_PL1X2	34553	WHD_GAT2	13.8	0.00	1	Fresno	Wilson		Market
PG&E	ZZ_JRWOOD_1_UNIT 1	34332	JRWCOGEN	9.11	0.00	1	Fresno	Wilson		QF/Selfgen
PG&E	ZZ_KERKH1_7_UNIT 2	34343	KERCK1-2	6.6	8.50	2	Fresno	Wilson, Herndon	No NQC - hist. data	Market
PG&E	ZZ_NA	34485	FRESNOWW	12.5	0.00	1	Fresno	Wilson	No NQC - hist. data	QF/Selfgen
PG&E	ZZ_NA	34485	FRESNOWW	12.5	0.10	2	Fresno	Wilson	No NQC - hist. data	QF/Selfgen
PG&E	ZZ_NA	34485	FRESNOWW	12.5	0.00	3	Fresno	Wilson	No NQC - hist. data	QF/Selfgen
PG&E	ZZZ_New Unit	34653	Q526	0.55	0.00	1	Fresno	Wilson, Coalinga	Energy Only	Market
PG&E	ZZZ_New Unit	34467	GIFFEN_DIST	12.5	4.10	1	Fresno	Wilson, Herndon	No NQC - est. data	Market
PG&E	ZZZ_New Unit	34649	Q965	0.36	5.53	1	Fresno	Wilson, Herndon, Hanford	No NQC - est. data	Market
PG&E	ZZZ_New Unit	365514	Q1032G1	0.55	7.87	1	Fresno	Wilson	No NQC - est. data	Market
PG&E	ZZZ_New Unit	365502	Q632BC1	0.55	8.28	1	Fresno	Wilson	No NQC - est. data	Market
PG&E	ZZZ_New Unit	34313	NORTHSTAR	0.55	61.60	1	Fresno	Wilson	No NQC - Pmax	Market
PG&E	ZZZ_New Unit	365520	Q1032G3	0.55	67.49	3	Fresno	Wilson	No NQC - est. data	Market
PG&E	ZZZ_New Unit	34689	ORO LOMA_3	12.5	20.00	EW	Fresno	Wilson	No NQC - Pmax	Market
PG&E	ZZZ_New Unit	34690	CORCORAN	12.5	8.20	FW	Fresno	Wilson, Herndon, Hanford	No NQC - est. data	Market
PG&E	ZZZ_New Unit	34692	CORCORAN	12.5	12.00	FW	Fresno	Wilson, Herndon, Hanford	No NQC - Pmax	Market
PG&E	ZZZ_New Unit	34651	JACALITO	0.55	0.00	RN	Fresno	Wilson, Coalinga	Not modeled Energy Only	Market
PG&E	ZZZ_New Unit	34603	JGBSWLT	12.5	0.00	ST	Fresno	Wilson, Herndon, Hanford	Energy Only	Market
PG&E	ZZZZ_New Unit	34335	Q723	0.32	20.50	1	Fresno	Wilson, Borden	No NQC - est. data	Market
PG&E	ZZZZ_New Unit	34688	Q272	0.55	50.43	1	Fresno	Wilson	No NQC - est. data	Market

Attachment A - List of physical resources by PTO, local area and market ID

PG&E	BRDGLV_7_BAKER				0.88		Humboldt	None	Not modeled Aug NQC	Net Seller
PG&E	FAIRHV_6_UNIT	31150	FAIRHAVN	13.8	13.58	1	Humboldt	None	Aug NQC	Net Seller
PG&E	FTSWRD_6_TRFORK				0.10		Humboldt	None	Not modeled Aug NQC	Market
PG&E	FTSWRD_7_QFUNTS				0.00		Humboldt	None	Not modeled Aug NQC	QF/Selfgen
PG&E	HUMBPP_1_UNITS3	31180	HUMB_G1	13.8	16.30	1	Humboldt	None		Market
PG&E	HUMBPP_1_UNITS3	31180	HUMB_G1	13.8	15.83	2	Humboldt	None		Market
PG&E	HUMBPP_1_UNITS3	31180	HUMB_G1	13.8	16.67	3	Humboldt	None		Market
PG&E	HUMBPP_1_UNITS3	31180	HUMB_G1	13.8	16.20	4	Humboldt	None		Market
PG&E	HUMBPP_6_UNITS	31181	HUMB_G2	13.8	16.14	5	Humboldt	None		Market
PG&E	HUMBPP_6_UNITS	31181	HUMB_G2	13.8	16.33	6	Humboldt	None		Market
PG&E	HUMBPP_6_UNITS	31181	HUMB_G2	13.8	16.24	7	Humboldt	None		Market
PG&E	HUMBPP_6_UNITS	31182	HUMB_G3	13.8	16.62	8	Humboldt	None		Market
PG&E	HUMBPP_6_UNITS	31182	HUMB_G3	13.8	16.33	9	Humboldt	None		Market
PG&E	HUMBPP_6_UNITS	31182	HUMB_G3	13.8	15.95	10	Humboldt	None		Market
PG&E	HUMBSB_1_QF				0.00		Humboldt	None	Not modeled Aug NQC	QF/Selfgen
PG&E	KEKAWK_6_UNIT	31166	KEKAWAK	9.1	0.80	1	Humboldt	None	Aug NQC	Net Seller
PG&E	LAPAC_6_UNIT	31158	LP SAMOA	12.5	0.00	1	Humboldt	None		Market
PG&E	LOWGAP_1_SUPHR				0.00		Humboldt	None	Not modeled Aug NQC	Market
PG&E	PACLUM_6_UNIT	31152	PAC.LUMB	13.8	9.31	1	Humboldt	None	Aug NQC	Net Seller
PG&E	PACLUM_6_UNIT	31152	PAC.LUMB	13.8	9.31	2	Humboldt	None	Aug NQC	Net Seller
PG&E	PACLUM_6_UNIT	31153	PAC.LUMB	2.4	5.59	3	Humboldt	None	Aug NQC	Net Seller
PG&E	ZZZZ_BULKE_6_BLUEL K	31156	BLUELKPP	12.5	0.00	1	Humboldt	None	Retired	Market
PG&E	7STDRD_1_SOLAR1	35065	7STNDRD_1	21	8.20	FW	Kern	South Kern PP, Kern Oil	Aug NQC	Market
PG&E	ADOBEE_1_SOLAR	35021	Q622B	34.5	8.20	1	Kern	South Kern PP	Aug NQC	Market
PG&E	BDGRCK_1_UNITS	35029	BADGERCK	13.8	43.00	1	Kern	South Kern PP	Aug NQC	Net Seller
PG&E	BEARMT_1_UNIT	35066	PSE-BEAR	13.8	45.00	1	Kern	South Kern PP, Westpark	Aug NQC	Net Seller
PG&E	BKRFLD_2_SOLAR1				0.57		Kern	South Kern PP	Not modeled Aug NQC	Market

Attachment A - List of physical resources by PTO, local area and market ID

PG&E	DEXZEL_1_UNIT	35024	DEXEL +	13.8	17.15	1	Kern	South Kern PP, Kern Oil	Aug NQC	Net Seller
PG&E	DISCOV_1_CHEVRN	35062	DISCOVERY	13.8	3.04	1	Kern	South Kern PP, Kern Oil	Aug NQC	QF/Selfgen
PG&E	DOUBLC_1_UNITS	35023	DOUBLE C	13.8	51.20	1	Kern	South Kern PP	Aug NQC	Net Seller
PG&E	KERNFT_1_UNITS	35026	KERNFRNT	9.11	51.30	1	Kern	South Kern PP	Aug NQC	Net Seller
PG&E	KRNCNY_6_UNIT	35018	KERNCNYN	11	3.42	1	Kern	South Kern PP	Aug NQC	Market
PG&E	LAMONT_1_SOLAR1	35019	REGULUS	0.4	24.60	1	Kern	South Kern PP	Aug NQC	Market
PG&E	LAMONT_1_SOLAR2	35092	Q744G4	0.38	8.20	1	Kern	South Kern PP	Aug NQC	Market
PG&E	LAMONT_1_SOLAR3	35087	Q744G3	0.4	6.15	3	Kern	South Kern PP	Aug NQC	Market
PG&E	LAMONT_1_SOLAR4	35059	Q744G2	0.4	22.06	2	Kern	South Kern PP	Aug NQC	Market
PG&E	LAMONT_1_SOLAR5	35054	Q744G1	0.4	6.83	1	Kern	South Kern PP	Aug NQC	Market
PG&E	LIVOAK_1_UNIT 1	35058	PSE-LVOK	9.1	42.70	1	Kern	South Kern PP, Kern Oil	Aug NQC	Net Seller
PG&E	MAGUND_1_BKISR1				0.00		Kern	South Kern PP, Kern Oil	Not modeled Aug NQC	Market
PG&E	MAGUND_1_BKSSR2				2.15		Kern	South Kern PP, Kern Oil	Not modeled Aug NQC	Market
PG&E	MTNPOS_1_UNIT	35036	MT POSO	13.8	46.64	1	Kern	South Kern PP, Kern Oil	Aug NQC	Net Seller
PG&E	OLDRIV_6_BIOGAS				1.62		Kern	South Kern PP	Not modeled Aug NQC	Market
PG&E	OLDRV1_6_SOLAR	35091	OLD_RVR1	12.5	8.20	1	Kern	South Kern PP	Aug NQC	Market
PG&E	RIOBRV_6_UNIT 1	35020	RIOBRAVO	9.1	1.26	1	Kern	South Kern PP	Aug NQC	Market
PG&E	SIERRA_1_UNITS	35027	HISIERRA	9.11	51.60	1	Kern	South Kern PP	Aug NQC	Market
PG&E	SKERN_6_SOLAR1	35089	S_KERN	0.48	8.20	1	Kern	South Kern PP, Kern PP 70 kV	Aug NQC	Market
PG&E	SKERN_6_SOLAR2	365563	Q885	0.36	4.10	1	Kern	South Kern PP, Kern PP 70 kV	Aug NQC	Market
PG&E	VEDDER_1_SEKERN	35046	SEKR	9.11	9.46	1	Kern	South Kern PP, Kern Oil	Aug NQC	QF/Selfgen
PG&E	ZZZZZ_OILDAL_1_UNIT 1	35028	OILDALE	9.11	0.00	RT	Kern	South Kern PP, Kern Oil	Retired	Net Seller
PG&E	ZZZZZ_ULTOGL_1_POSO	35035	ULTR PWR	9.11	0.00	1	Kern	South Kern PP, Kern Oil	Retired	QF/Selfgen
PG&E	ADLIN_1_UNITS	31435	GEO.ENGY	9.1	8.00	1	NCNB	Eagle Rock, Fulton, Lakeville		Market

Attachment A - List of physical resources by PTO, local area and market ID

PG&E	ADLIN_1_UNITS	31435	GEO.ENGY	9.1	8.00	2	NCNB	Eagle Rock, Fulton, Lakeville		Market
PG&E	CLOVDL_1_SOLAR				0.00		NCNB	Eagle Rock, Fulton, Lakeville	Not modeled Aug NQC	Market
PG&E	CSTOGA_6_LNDFIL				0.00		NCNB	Fulton, Lakeville	Not modeled Energy Only	Market
PG&E	FULTON_1_QF				0.01		NCNB	Fulton, Lakeville	Not modeled Aug NQC	QF/Selfgen
PG&E	GEYS11_7_UNIT11	31412	GEYSER11	13.8	68.00	1	NCNB	Eagle Rock, Fulton, Lakeville		Market
PG&E	GEYS12_7_UNIT12	31414	GEYSER12	13.8	50.00	1	NCNB	Fulton, Lakeville		Market
PG&E	GEYS13_7_UNIT13	31416	GEYSER13	13.8	56.00	1	NCNB	Lakeville		Market
PG&E	GEYS14_7_UNIT14	31418	GEYSER14	13.8	50.00	1	NCNB	Fulton, Lakeville		Market
PG&E	GEYS16_7_UNIT16	31420	GEYSER16	13.8	49.00	1	NCNB	Fulton, Lakeville		Market
PG&E	GEYS17_7_UNIT17	31422	GEYSER17	13.8	56.00	1	NCNB	Fulton, Lakeville		Market
PG&E	GEYS18_7_UNIT18	31424	GEYSER18	13.8	45.00	1	NCNB	Lakeville		Market
PG&E	GEYS20_7_UNIT20	31426	GEYSER20	13.8	40.00	1	NCNB	Lakeville		Market
PG&E	GYS5X6_7_UNITS	31406	GEYSR5-6	13.8	42.50	1	NCNB	Eagle Rock, Fulton, Lakeville		Market
PG&E	GYS5X6_7_UNITS	31406	GEYSR5-6	13.8	42.50	2	NCNB	Eagle Rock, Fulton, Lakeville		Market
PG&E	GYS7X8_7_UNITS	31408	GEYSER78	13.8	38.00	1	NCNB	Eagle Rock, Fulton, Lakeville		Market
PG&E	GYS7X8_7_UNITS	31408	GEYSER78	13.8	38.00	2	NCNB	Eagle Rock, Fulton, Lakeville		Market
PG&E	GYSRVL_7_WSPRNG				1.34		NCNB	Fulton, Lakeville	Not modeled Aug NQC	QF/Selfgen
PG&E	HILAND_7_YOLOWD				0.00		NCNB	Eagle Rock, Fulton, Lakeville	Not Modeled. Energy Only	Market
PG&E	IGNACO_1_QF				0.13		NCNB	Lakeville	Not modeled Aug NQC	QF/Selfgen
PG&E	INDVLY_1_UNITS	31436	INDIAN V	9.1	1.11	1	NCNB	Eagle Rock, Fulton, Lakeville	Aug NQC	Net Seller
PG&E	MONTPH_7_UNITS	32700	MONTICLO	9.1	3.03	1	NCNB	Fulton, Lakeville	Aug NQC	Market
PG&E	MONTPH_7_UNITS	32700	MONTICLO	9.1	3.03	2	NCNB	Fulton, Lakeville	Aug NQC	Market
PG&E	MONTPH_7_UNITS	32700	MONTICLO	9.1	0.91	3	NCNB	Fulton, Lakeville	Aug NQC	Market

Attachment A - List of physical resources by PTO, local area and market ID

PG&E	NCPA_7_GP1UN1	38106	NCPA1GY1	13.8	31.00	1	NCNB	Lakeville	Aug NQC	MUNI
PG&E	NCPA_7_GP1UN2	38108	NCPA1GY2	13.8	28.00	1	NCNB	Lakeville	Aug NQC	MUNI
PG&E	NCPA_7_GP2UN3	38110	NCPA2GY1	13.8	0.00	1	NCNB	Fulton, Lakeville	Aug NQC	MUNI
PG&E	NCPA_7_GP2UN4	38112	NCPA2GY2	13.8	52.73	1	NCNB	Fulton, Lakeville	Aug NQC	MUNI
PG&E	POTTER_6_UNITS	31433	POTTRVLY	2.4	0.97	1	NCNB	Eagle Rock, Fulton, Lakeville	Aug NQC	Market
PG&E	POTTER_6_UNITS	31433	POTTRVLY	2.4	0.44	3	NCNB	Eagle Rock, Fulton, Lakeville	Aug NQC	Market
PG&E	POTTER_6_UNITS	31433	POTTRVLY	2.4	0.44	4	NCNB	Eagle Rock, Fulton, Lakeville	Aug NQC	Market
PG&E	POTTER_7_VECINO				0.00		NCNB	Eagle Rock, Fulton, Lakeville	Not modeled Aug NQC	QF/Selfgen
PG&E	SANTFG_7_UNITS	31400	SANTA FE	13.8	31.50	1	NCNB	Lakeville		Market
PG&E	SANTFG_7_UNITS	31400	SANTA FE	13.8	31.50	2	NCNB	Lakeville		Market
PG&E	SMUDGO_7_UNIT 1	31430	SMUDGE01	13.8	47.00	1	NCNB	Lakeville		Market
PG&E	SNMALF_6_UNITS	31446	SONMA LF	9.1	3.92	1	NCNB	Fulton, Lakeville	Aug NQC	QF/Selfgen
PG&E	UKIAH_7_LAKEMN	38020	CITY UKH	115	0.49	1	NCNB	Eagle Rock, Fulton, Lakeville	Aug NQC	MUNI
PG&E	UKIAH_7_LAKEMN	38020	CITY UKH	115	1.21	2	NCNB	Eagle Rock, Fulton, Lakeville	Aug NQC	MUNI
PG&E	WDFRDF_2_UNITS	31404	WEST FOR	13.8	12.50	1	NCNB	Fulton, Lakeville		Market
PG&E	WDFRDF_2_UNITS	31404	WEST FOR	13.8	12.50	2	NCNB	Fulton, Lakeville		Market
PG&E	ZZZ_New Unit	365542	Q1221	13.8	35.00	1	NCNB	Eagle Rock, Fulton, Lakeville	No NQC - Pmax	Market
PG&E	ZZZZ_BEARN_2_UNIT S	31402	BEAR CAN	13.8	0.00	1	NCNB	Fulton, Lakeville	Retired	Market
PG&E	ZZZZ_BEARN_2_UNIT S	31402	BEAR CAN	13.8	0.00	2	NCNB	Fulton, Lakeville	Retired	Market
PG&E	ZZZZZZ_GEYS17_2_BOT RCK	31421	BOTTLERK	13.8	0.00	1	NCNB	Fulton, Lakeville	Retired	Market
PG&E	ALLGNY_6_HYDRO1				0.08		Sierra	South of Table Mountain	Not modeled Aug NQC	Market
PG&E	APLHIL_1_SLABCK				0.00	1	Sierra	Placerville, South of Rio Oso, South of Palermo, South of Table Mountain	Not modeled Energy Only	Market

Attachment A - List of physical resources by PTO, local area and market ID

PG&E	BANGOR_6_HYDRO				0.32		Sierra	South of Table Mountain	Not modeled Aug NQC	Market
PG&E	BELDEN_7_UNIT 1	31784	BELDEN	13.8	119.00	1	Sierra	South of Palermo, South of Table Mountain	Aug NQC	Market
PG&E	BIOMAS_1_UNIT 1	32156	WOODLAND	9.11	24.94	1	Sierra	Drum-Rio Oso, South of Palermo, South of Table Mountain	Aug NQC	Net Seller
PG&E	BNNIEN_7_ALTAPH	32376	BONNIE N	60	0.56		Sierra	Weimer, Placer, Drum-Rio Oso, South of Rio Oso, South of Palermo, South of Table Mountain	Not modeled Aug NQC	Market
PG&E	BOGUE_1_UNITA1	32451	FREC	13.8	47.60	1	Sierra	Bogue, Drum-Rio Oso, South of Table Mountain	Aug NQC	Market
PG&E	BOWMN_6_HYDRO	32480	BOWMAN	9.11	1.57	1	Sierra	Drum-Rio Oso, South of Palermo, South of Table Mountain	Aug NQC	MUNI
PG&E	BUCKCK_2_HYDRO				0.29		Sierra	South of Palermo, South of Table Mountain	Not modeled Aug NQC	Market
PG&E	BUCKCK_7_OAKFLT				1.30		Sierra	South of Palermo, South of Table Mountain	Not modeled Aug NQC	Market
PG&E	BUCKCK_7_PL1X2	31820	BCKS CRK	11	30.63	1	Sierra	South of Palermo, South of Table Mountain	Aug NQC	Market
PG&E	BUCKCK_7_PL1X2	31820	BCKS CRK	11	26.62	2	Sierra	South of Palermo, South of Table Mountain	Aug NQC	Market
PG&E	CAMPFW_7_FARWST	32470	CMP.FARW	9.11	2.90	1	Sierra	South of Table Mountain	Aug NQC	MUNI

Attachment A - List of physical resources by PTO, local area and market ID

PG&E	CHICPK_7_UNIT 1	32462	CHI.PARK	11.5	42.00	1	Sierra	Placer, Drum-Rio Oso, South of Rio Oso, South of Palermo, South of Table Mountain	Aug NQC	MUNI
PG&E	COLGAT_7_UNIT 1	32450	COLGATE1	13.8	161.65	1	Sierra	South of Table Mountain	Aug NQC	MUNI
PG&E	COLGAT_7_UNIT 2	32452	COLGATE2	13.8	161.68	1	Sierra	South of Table Mountain	Aug NQC	MUNI
PG&E	CRESTA_7_PL1X2	31812	CRESTA	11.5	34.66	1	Sierra	South of Palermo, South of Table Mountain	Aug NQC	Market
PG&E	CRESTA_7_PL1X2	31812	CRESTA	11.5	35.34	2	Sierra	South of Palermo, South of Table Mountain	Aug NQC	Market
PG&E	DAVIS_1_SOLAR1				0.41		Sierra	Drum-Rio Oso, South of Palermo, South of Table Mountain	Not modeled Aug NQC	Market
PG&E	DAVIS_1_SOLAR2				0.41		Sierra	Drum-Rio Oso, South of Palermo, South of Table Mountain	Not modeled Aug NQC	Market
PG&E	DAVIS_7_MNMETH				1.80		Sierra	Drum-Rio Oso, South of Palermo, South of Table Mountain	Not modeled Aug NQC	Market
PG&E	DEADCK_1_UNIT	31862	DEADWOOD	9.11	0.00	1	Sierra	Drum-Rio Oso, South of Table Mountain	Aug NQC	MUNI
PG&E	DEERCR_6_UNIT 1	32474	DEER CRK	9.11	7.00	1	Sierra	Drum-Rio Oso, South of Palermo, South of Table Mountain	Aug NQC	Market
PG&E	DRUM_7_PL1X2	32504	DRUM 1-2	6.6	13.00	1	Sierra	Drum-Rio Oso, South of Palermo, South of Table Mountain	Aug NQC	Market
PG&E	DRUM_7_PL1X2	32504	DRUM 1-2	6.6	13.00	2	Sierra	Drum-Rio Oso, South of Palermo, South of Table Mountain	Aug NQC	Market

Attachment A - List of physical resources by PTO, local area and market ID

PG&E	DRUM_7_PL3X4	32506	DRUM 3-4	6.6	13.26	1	Sierra	Drum-Rio Oso, South of Palermo, South of Table Mountain	Aug NQC	Market
PG&E	DRUM_7_PL3X4	32506	DRUM 3-4	6.6	15.64	2	Sierra	Drum-Rio Oso, South of Palermo, South of Table Mountain	Aug NQC	Market
PG&E	DRUM_7_UNIT 5	32454	DRUM 5	13.8	50.00	1	Sierra	Drum-Rio Oso, South of Palermo, South of Table Mountain	Aug NQC	Market
PG&E	DUTCH1_7_UNIT 1	32464	DTCHFLT1	11	22.00	1	Sierra	Placer, Drum-Rio Oso, South of Rio Oso, South of Palermo, South of Table Mountain	Aug NQC	Market
PG&E	DUTCH2_7_UNIT 1	32502	DTCHFLT2	6.9	26.00	1	Sierra	Drum-Rio Oso, South of Palermo, South of Table Mountain	Aug NQC	MUNI
PG&E	ELDORO_7_UNIT 1	32513	ELDRADO1	21.6	11.00	1	Sierra	Placerville, South of Rio Oso, South of Palermo, South of Table Mountain		Market
PG&E	ELDORO_7_UNIT 2	32514	ELDRADO2	21.6	11.00	1	Sierra	Placerville, South of Rio Oso, South of Palermo, South of Table Mountain		Market
PG&E	FMEADO_6_HELLHL	32486	HELLHOLE	9.11	0.32	1	Sierra	South of Rio Oso, South of Palermo, South of Table Mountain	Aug NQC	MUNI
PG&E	FMEADO_7_UNIT	32508	FRNCH MD	4.2	16.00	1	Sierra	South of Rio Oso, South of Palermo, South of Table Mountain	Aug NQC	MUNI
PG&E	FORBST_7_UNIT 1	31814	FORBSTWN	11.5	37.50	1	Sierra	Drum-Rio Oso, South of Table Mountain	Aug NQC	MUNI

Attachment A - List of physical resources by PTO, local area and market ID

PG&E	GOLDHL_1_QF				0.33		Sierra	Placerville, South of Rio Oso, South of Palermo, South of Table Mountain	Not modeled	QF/Selfgen
PG&E	GRIDLY_6_SOLAR	38054	GRIDLEY	60	0.00	1	Sierra	Pease, South of Table Mountain	Energy Only	Market
PG&E	GRNLF1_1_UNITS	32490	GRNLEAF1	13.8	33.36	1	Sierra	Bogue, Drum-Rio Oso, South of Table Mountain	Aug NQC	Market
PG&E	GRNLF1_1_UNITS	32491	GRNLEAF1	13.8	15.84	2	Sierra	Bogue, Drum-Rio Oso, South of Table Mountain	Aug NQC	Market
PG&E	GRNLF2_1_UNIT	32492	GRNLEAF2	13.8	36.45	1	Sierra	Pease, Drum-Rio Oso, South of Table Mountain	Aug NQC	QF/Selfgen
PG&E	HALSEY_6_UNIT	32478	HALSEY F	9.11	13.50	1	Sierra	Placer, Drum-Rio Oso, South of Rio Oso, South of Palermo, South of Table Mountain	Aug NQC	Market
PG&E	HAYPRS_6_QFUNTS	32488	HAYPRES+	9.11	0.00	1	Sierra	Drum-Rio Oso, South of Palermo, South of Table Mountain	Aug NQC	QF/Selfgen
PG&E	HAYPRS_6_QFUNTS	32488	HAYPRES+	9.11	0.00	2	Sierra	Drum-Rio Oso, South of Palermo, South of Table Mountain	Aug NQC	QF/Selfgen
PG&E	HIGGNS_1_COMBIE				0.00		Sierra	Drum-Rio Oso, South of Rio Oso, South of Palermo, South of Table Mountain	Not modeled Energy Only	Market
PG&E	HIGGNS_7_QFUNTS				0.23		Sierra	Drum-Rio Oso, South of Rio Oso, South of Palermo, South of Table Mountain	Not modeled Aug NQC	QF/Selfgen
PG&E	KANAKA_1_UNIT				0.00		Sierra	Drum-Rio Oso, South of Table Mountain	Not modeled Aug NQC	MUNI

Attachment A - List of physical resources by PTO, local area and market ID

PG&E	KELYRG_6_UNIT	31834	KELLYRDG	9.11	11.00	1	Sierra	Drum-Rio Oso, South of Table Mountain	Aug NQC	MUNI
PG&E	LIVEOK_6_SOLAR				0.51		Sierra	Pease, South of Table Mountain	Not modeled Aug NQC	Market
PG&E	LODIEC_2_PL1X2	38124	LODI ST1	18	95.82	1	Sierra	South of Rio Oso, South of Palermo, South of Table Mountain		MUNI
PG&E	LODIEC_2_PL1X2	38123	LODI CT1	18	184.18	1	Sierra	South of Rio Oso, South of Palermo, South of Table Mountain		MUNI
PG&E	MDFKRL_2_PROJCT	32456	MIDLFORK	13.8	63.94	1	Sierra	South of Rio Oso, South of Palermo, South of Table Mountain	Aug NQC	MUNI
PG&E	MDFKRL_2_PROJCT	32458	RALSTON	13.8	82.13	1	Sierra	South of Rio Oso, South of Palermo, South of Table Mountain	Aug NQC	MUNI
PG&E	MDFKRL_2_PROJCT	32456	MIDLFORK	13.8	63.94	2	Sierra	South of Rio Oso, South of Palermo, South of Table Mountain	Aug NQC	MUNI
PG&E	NAROW1_2_UNIT	32466	NARROWS1	9.1	12.00	1	Sierra	South of Table Mountain	Aug NQC	Market
PG&E	NAROW2_2_UNIT	32468	NARROWS2	9.1	28.51	1	Sierra	South of Table Mountain	Aug NQC	MUNI
PG&E	NWCSTL_7_UNIT 1	32460	NEWCASTLE	13.2	12.00	1	Sierra	Placer, Drum-Rio Oso, South of Rio Oso, South of Palermo, South of Table Mountain	Aug NQC	Market
PG&E	OROVIL_6_UNIT	31888	OROVILLE	9.11	7.50	1	Sierra	Drum-Rio Oso, South of Table Mountain	Aug NQC	Market

Attachment A - List of physical resources by PTO, local area and market ID

PG&E	OXBOW_6_DRUM	32484	OXBOW F	9.11	6.00	1	Sierra	Weimer, Drum-Rio Oso, South of Palermo, South of Table Mountain	Aug NQC	MUNI
PG&E	PLACVL_1_CHILIB	32510	CHILIBAR	4.2	0.00	1	Sierra	Placerville, South of Rio Oso, South of Palermo, South of Table Mountain	Aug NQC	Market
PG&E	PLACVL_1_RCKCRE				2.18		Sierra	Placerville, South of Rio Oso, South of Palermo, South of Table Mountain	Not modeled Aug NQC	Market
PG&E	PLSNTG_7_LNCLND	32408	PLSNT GR	60	3.26		Sierra	Drum-Rio Oso, South of Rio Oso, South of Palermo, South of Table Mountain	Not modeled Aug NQC	Market
PG&E	POEPH_7_UNIT 1	31790	POE 1	13.8	60.00	1	Sierra	South of Palermo, South of Table Mountain	Aug NQC	Market
PG&E	POEPH_7_UNIT 2	31792	POE 2	13.8	60.00	1	Sierra	South of Palermo, South of Table Mountain	Aug NQC	Market
PG&E	RCKCRK_7_UNIT 1	31786	ROCK CK1	13.8	57.00	1	Sierra	South of Palermo, South of Table Mountain	Aug NQC	Market
PG&E	RCKCRK_7_UNIT 2	31788	ROCK CK2	13.8	56.90	1	Sierra	South of Palermo, South of Table Mountain	Aug NQC	Market
PG&E	RIOOSO_1_QF				0.93		Sierra	Drum-Rio Oso, South of Palermo, South of Table Mountain	Not modeled Aug NQC	QF/Selfgen
PG&E	ROLLIN_6_UNIT	32476	ROLLINSF	9.11	13.50	1	Sierra	Weimer, Drum-Rio Oso, South of Palermo, South of Table Mountain	Aug NQC	MUNI
PG&E	SLYCRK_1_UNIT 1	31832	SLY.CR.	9.11	13.00	1	Sierra	Drum-Rio Oso, South of Table Mountain	Aug NQC	Market

Attachment A - List of physical resources by PTO, local area and market ID

PG&E	SPAULD_6_UNIT 3	32472	SPAULDG	9.11	6.50	3	Sierra	Drum-Rio Oso, South of Palermo, South of Table Mountain	Aug NQC	Market
PG&E	SPAULD_6_UNIT12	32472	SPAULDG	9.11	7.00	1	Sierra	Drum-Rio Oso, South of Palermo, South of Table Mountain	Aug NQC	Market
PG&E	SPAULD_6_UNIT12	32472	SPAULDG	9.11	4.40	2	Sierra	Drum-Rio Oso, South of Palermo, South of Table Mountain	Aug NQC	Market
PG&E	SPI LI_2_UNIT 1	32498	SPILINCF	12.5	12.99	1	Sierra	Drum-Rio Oso, South of Rio Oso, South of Palermo, South of Table Mountain	Aug NQC	Net Seller
PG&E	STIGCT_2_LODI	38114	Stig CC	13.8	49.50	1	Sierra	South of Rio Oso, South of Palermo, South of Table Mountain		MUNI
PG&E	ULTRCK_2_UNIT	32500	ULTR RCK	9.11	22.83	1	Sierra	Drum-Rio Oso, South of Rio Oso, South of Palermo, South of Table Mountain	Aug NQC	Market
PG&E	WDLEAF_7_UNIT 1	31794	WOODLEAF	13.8	60.00	1	Sierra	Drum-Rio Oso, South of Table Mountain	Aug NQC	MUNI
PG&E	WHEATL_6_LNDFIL	32350	WHEATLND	60	3.20		Sierra	South of Table Mountain	Not modeled Aug NQC	Market
PG&E	WISE_1_UNIT 1	32512	WISE	12	14.50	1	Sierra	Placer, Drum-Rio Oso, South of Rio Oso, South of Palermo, South of Table Mountain	Aug NQC	Market
PG&E	WISE_1_UNIT 2	32512	WISE	12	3.20	1	Sierra	Placer, Drum-Rio Oso, South of Rio Oso, South of Palermo, South of Table Mountain	Aug NQC	Market

Attachment A - List of physical resources by PTO, local area and market ID

PG&E	YUBACT_1_SUNSWT	32494	YUBA CTY	9.11	49.97	1	Sierra	Pease, Drum-Rio Oso, South of Table Mountain	Aug NQC	Net Seller
PG&E	YUBACT_6_UNITA1	32496	YCEC	13.8	47.60	1	Sierra	Pease, Drum-Rio Oso, South of Table Mountain		Market
PG&E	ZZ_NA	32162	RIV.DLTA	9.11	0.00	1	Sierra	Drum-Rio Oso, South of Palermo, South of Table Mountain	No NQC - hist. data	QF/Selfgen
PG&E	ZZ_UCDAVS_1_UNIT	32166	UC DAVIS	9.11	0.00	RN	Sierra	Drum-Rio Oso, South of Palermo, South of Table Mountain	No NQC - hist. data	QF/Selfgen
PG&E	ZZZ_New Unit	365510	Q653F	0.48	4.92	1	Sierra	Drum-Rio Oso, South of Palermo, South of Table Mountain	No NQC - est. data	Market
PG&E	ZZZZ_PACORO_6_UNIT	31890	PO POWER	9.11	0.00	1	Sierra	Drum-Rio Oso, South of Table Mountain	Retired	QF/Selfgen
PG&E	ZZZZ_PACORO_6_UNIT	31890	PO POWER	9.11	0.00	2	Sierra	Drum-Rio Oso, South of Table Mountain	Retired	QF/Selfgen
PG&E	BEARDS_7_UNIT 1	34074	BEARDSLY	6.9	8.36	1	Stockton	Tesla-Bellota, Stanislaus	Aug NQC	MUNI
PG&E	CAMCHE_1_PL1X3	33850	CAMANCHE	4.2	0.20	1	Stockton	Tesla-Bellota	Aug NQC	MUNI
PG&E	CAMCHE_1_PL1X3	33850	CAMANCHE	4.2	0.20	2	Stockton	Tesla-Bellota	Aug NQC	MUNI
PG&E	CAMCHE_1_PL1X3	33850	CAMANCHE	4.2	0.20	3	Stockton	Tesla-Bellota	Aug NQC	MUNI
PG&E	COGNAT_1_UNIT	33818	STCKNBIOMASS	13.8	42.33	1	Stockton	Weber	Aug NQC	Net Seller
PG&E	CRWCKS_1_SOLAR1	34051	Q539	34.5	0.00	1	Stockton	Tesla-Bellota	Energy Only	Market
PG&E	DONNLS_7_UNIT	34058	DONNELLS	13.8	72.00	1	Stockton	Tesla-Bellota, Stanislaus	Aug NQC	MUNI
PG&E	FROGTN_1_UTICAA				0.49		Stockton	Tesla-Bellota, Stanislaus	Not Modeled Aug NQC	Market
PG&E	FROGTN_7_UTICA				0.00		Stockton	Tesla-Bellota, Stanislaus	Not modeled Energy Only	Market
PG&E	LOCKFD_1_BEARCK				0.62		Stockton	Tesla-Bellota	Not modeled Energy Only	Market

Attachment A - List of physical resources by PTO, local area and market ID

PG&E	LOCKFD_1_KSOLAR				0.41		Stockton	Tesla-Bellota	Not modeled Energy Only	Market
PG&E	LODI25_2_UNIT 1	38120	LODI25CT	9.11	23.80	1	Stockton	Lockeford		MUNI
PG&E	MANTEC_1_ML1SR1				0.00		Stockton	Tesla-Bellota	Not modeled Energy Only	Market
PG&E	PEORIA_1_SOLAR				0.62		Stockton	Tesla-Bellota, Stanislaus	Not modeled Aug NQC	Market
PG&E	PHOENX_1_UNIT				0.90		Stockton	Tesla-Bellota, Stanislaus	Not modeled Aug NQC	Market
PG&E	SCHLTE_1_PL1X3	33805	GWFTRCY1	13.8	88.55	1	Stockton	Tesla-Bellota		Market
PG&E	SCHLTE_1_PL1X3	33807	GWFTRCY2	13.8	88.55	1	Stockton	Tesla-Bellota		Market
PG&E	SCHLTE_1_PL1X3	33811	GWFTRCY3	13.8	142.70	1	Stockton	Tesla-Bellota		Market
PG&E	SMPRIIP_1_SMPSON	33810	SP CMPNY	13.8	46.05	1	Stockton	Tesla-Bellota	Aug NQC	Market
PG&E	SNDBAR_7_UNIT 1	34060	SANDBAR	13.8	7.06	1	Stockton	Tesla-Bellota, Stanislaus	Aug NQC	MUNI
PG&E	SPIFBD_1_PL1X2	34055	SPISONORA	13.8	2.32	1	Stockton	Tesla-Bellota, Stanislaus	Aug NQC	Market
PG&E	SPRGAP_1_UNIT 1	34078	SPRNG GP	6	7.00	1	Stockton	Tesla-Bellota, Stanislaus	Aug NQC	Market
PG&E	STANIS_7_UNIT 1	34062	STANISLS	13.8	91.00	1	Stockton	Tesla-Bellota, Stanislaus	Aug NQC	Market
PG&E	STNRES_1_UNIT	34056	STNSLSRP	13.8	19.27	1	Stockton	Tesla-Bellota	Aug NQC	Net Seller
PG&E	THMENG_1_UNIT 1	33806	TH.E.DV.	13.8	4.89	1	Stockton	Tesla-Bellota	Aug NQC	Net Seller
PG&E	TULLCK_7_UNITS	34076	TULLOCH	6.9	4.79	1	Stockton	Tesla-Bellota	Aug NQC	MUNI
PG&E	TULLCK_7_UNITS	34076	TULLOCH	6.9	5.39	2	Stockton	Tesla-Bellota	Aug NQC	MUNI
PG&E	TULLCK_7_UNITS	34076	TULLOCH	6.9	3.54	3	Stockton	Tesla-Bellota	Aug NQC	MUNI
PG&E	ULTPCH_1_UNIT 1	34050	CH.STN.	13.8	16.19	1	Stockton	Tesla-Bellota, Stanislaus	Aug NQC	QF/Selfgen
PG&E	VLYHOM_7_SSJID				0.57		Stockton	Tesla-Bellota, Stanislaus	Not modeled Aug NQC	MUNI
PG&E	WEBER_6_FORWRD				4.20		Stockton	Weber	Not modeled Aug NQC	Market
PG&E	ZZ_NA	33830	GEN.MILL	9.11	0.00	1	Stockton	Lockeford	No NQC - hist. data	QF/Selfgen
PG&E	ZZ_NA	33687	STKTN WW	60	1.50	1	Stockton	Weber	No NQC - hist. data	QF/Selfgen

Attachment A - List of physical resources by PTO, local area and market ID

PG&E	ZZ_NA	33821	PAC_ETH	12.5	0.00	RN	Stockton	Weber	No NQC - hist. data	QF/Selfgen
PG&E	ZZZZZ_STOKCG_1_UNIT 1	33814	INGREDION	12.5	0.00	RN	Stockton	Tesla-Bellota	Retired	QF/Selfgen
PG&E	ZZZZZZZ_SANJOA_1_UNI T 1	33808	SJ COGEN	13.8	0.00	1	Stockton	Tesla-Bellota	Retired	QF/Selfgen
SCE	ACACIA_6_SOLAR	29878	ACACIA_G	0.48	8.20	EQ	BC/Ventura	Big Creek	Energy Only	Market
SCE	ALAMO_6_UNIT	25653	ALAMO SC	13.8	15.07	1	BC/Ventura	Big Creek	Aug NQC	MUNI
SCE	BIGCRK_2_EXESWD	24323	PORTAL	4.8	9.45	1	BC/Ventura	Big Creek, Rector, Vestal	Aug NQC	Market
SCE	BIGCRK_2_EXESWD	24306	B CRK1-1	7.2	19.58	1	BC/Ventura	Big Creek, Rector, Vestal	Aug NQC	Market
SCE	BIGCRK_2_EXESWD	24311	B CRK3-1	13.8	34.44	1	BC/Ventura	Big Creek, Rector, Vestal	Aug NQC	Market
SCE	BIGCRK_2_EXESWD	24308	B CRK2-1	13.8	49.99	1	BC/Ventura	Big Creek, Rector, Vestal	Aug NQC	Market
SCE	BIGCRK_2_EXESWD	24317	MAMOTH1G	13.8	92.02	1	BC/Ventura	Big Creek, Rector, Vestal	Aug NQC	Market
SCE	BIGCRK_2_EXESWD	24306	B CRK1-1	7.2	21.26	2	BC/Ventura	Big Creek, Rector, Vestal	Aug NQC	Market
SCE	BIGCRK_2_EXESWD	24311	B CRK3-1	13.8	33.46	2	BC/Ventura	Big Creek, Rector, Vestal	Aug NQC	Market
SCE	BIGCRK_2_EXESWD	24308	B CRK2-1	13.8	51.18	2	BC/Ventura	Big Creek, Rector, Vestal	Aug NQC	Market
SCE	BIGCRK_2_EXESWD	24318	MAMOTH2G	13.8	92.02	2	BC/Ventura	Big Creek, Rector, Vestal	Aug NQC	Market
SCE	BIGCRK_2_EXESWD	24309	B CRK2-2	7.2	18.40	3	BC/Ventura	Big Creek, Rector, Vestal	Aug NQC	Market
SCE	BIGCRK_2_EXESWD	24307	B CRK1-2	13.8	21.26	3	BC/Ventura	Big Creek, Rector, Vestal	Aug NQC	Market
SCE	BIGCRK_2_EXESWD	24312	B CRK3-2	13.8	34.44	3	BC/Ventura	Big Creek, Rector, Vestal	Aug NQC	Market
SCE	BIGCRK_2_EXESWD	24309	B CRK2-2	7.2	19.39	4	BC/Ventura	Big Creek, Rector, Vestal	Aug NQC	Market
SCE	BIGCRK_2_EXESWD	24307	B CRK1-2	13.8	30.71	4	BC/Ventura	Big Creek, Rector, Vestal	Aug NQC	Market
SCE	BIGCRK_2_EXESWD	24312	B CRK3-2	13.8	35.43	4	BC/Ventura	Big Creek, Rector, Vestal	Aug NQC	Market

Attachment A - List of physical resources by PTO, local area and market ID

SCE	BIGCRK_2_EXESWD	24310	B CRK2-3	7.2	16.73	5	BC/Ventura	Big Creek, Rector, Vestal	Aug NQC	Market
SCE	BIGCRK_2_EXESWD	24313	B CRK3-3	13.8	35.92	5	BC/Ventura	Big Creek, Rector, Vestal	Aug NQC	Market
SCE	BIGCRK_2_EXESWD	24310	B CRK2-3	7.2	18.21	6	BC/Ventura	Big Creek, Rector, Vestal	Aug NQC	Market
SCE	BIGCRK_2_EXESWD	24314	B CRK 4	11.5	49.60	41	BC/Ventura	Big Creek, Rector, Vestal	Aug NQC	Market
SCE	BIGCRK_2_EXESWD	24314	B CRK 4	11.5	49.80	42	BC/Ventura	Big Creek, Rector, Vestal	Aug NQC	Market
SCE	BIGCRK_2_EXESWD	24315	B CRK 8	13.8	24.01	81	BC/Ventura	Big Creek, Rector, Vestal	Aug NQC	Market
SCE	BIGCRK_2_EXESWD	24315	B CRK 8	13.8	43.30	82	BC/Ventura	Big Creek, Rector, Vestal	Aug NQC	Market
SCE	BIGCRK_7_DAM7				0.00		BC/Ventura	Big Creek, Rector, Vestal	Not modeled Energy Only	Market
SCE	BIGCRK_7_MAMRES				0.00		BC/Ventura	Big Creek, Rector, Vestal	Not modeled Energy Only	Market
SCE	BIGSKY_2_BSKSR6	29742	BSKY G BC	0.42	8.20	1	BC/Ventura	Big Creek	Aug NQC	Market
SCE	BIGSKY_2_BSKSR7	29703	BSKY G WABS	0.42	8.20	1	BC/Ventura	Big Creek	Aug NQC	Market
SCE	BIGSKY_2_BSKSR8	29724	BSKY G ABSR	0.38	8.20	1	BC/Ventura	Big Creek	Aug NQC	Market
SCE	BIGSKY_2_SOLAR1	29727	BSKY G SMR	0.42	8.20	1	BC/Ventura	Big Creek	Aug NQC	Market
SCE	BIGSKY_2_SOLAR2	29701	BSKY_G_ESC	0.42	34.02	1	BC/Ventura	Big Creek	Aug NQC	Market
SCE	BIGSKY_2_SOLAR3	29745	BSKY_G_BD	0.42	8.20	1	BC/Ventura	Big Creek	Aug NQC	Market
SCE	BIGSKY_2_SOLAR4	29736	BSKY_G_BA	0.42	17.07	1	BC/Ventura	Big Creek	Aug NQC	Market
SCE	BIGSKY_2_SOLAR5	29739	BSKY_G_BB	0.42	2.05	1	BC/Ventura	Big Creek	Aug NQC	Market
SCE	BIGSKY_2_SOLAR6	29730	BSKY_G_SOL V	0.42	34.85	1	BC/Ventura	Big Creek	Aug NQC	Market
SCE	BIGSKY_2_SOLAR7	29733	BSKY_G_ADS R	0.42	20.50	1	BC/Ventura	Big Creek	Aug NQC	Market
SCE	CEDUCR_2_SOLAR1	25049	DUCOR1	0.39	0.00	EQ	BC/Ventura	Big Creek, Vestal	Energy Only	Market
SCE	CEDUCR_2_SOLAR2	25052	DUCOR2	0.39	0.00	EQ	BC/Ventura	Big Creek, Vestal	Energy Only	Market
SCE	CEDUCR_2_SOLAR3	25055	DUCOR3	0.39	0.00	EQ	BC/Ventura	Big Creek, Vestal	Energy Only	Market
SCE	CEDUCR_2_SOLAR4	25058	DUCOR4	0.39	0.00	EQ	BC/Ventura	Big Creek, Vestal	Energy Only	Market
SCE	DELSUR_6_CREST				0.00		BC/Ventura	Big Creek	Energy Only	Market

Attachment A - List of physical resources by PTO, local area and market ID

SCE	DELSUR_6_DRYFRB				2.05		BC/Ventura	Big Creek	Not modeled Aug NQC	Market
SCE	DELSUR_6_SOLAR1				2.67		BC/Ventura	Big Creek	Not modeled Aug NQC	Market
SCE	EASTWD_7_UNIT	24319	EASTWOOD	13.8	199.00	1	BC/Ventura	Big Creek, Rector, Vestal		Market
SCE	EDMONS_2_NSPIN	25605	EDMON1AP	14.4	16.86	1	BC/Ventura	Big Creek	Pumps	MUNI
SCE	EDMONS_2_NSPIN	25606	EDMON2AP	14.4	16.86	2	BC/Ventura	Big Creek	Pumps	MUNI
SCE	EDMONS_2_NSPIN	25607	EDMON3AP	14.4	16.86	3	BC/Ventura	Big Creek	Pumps	MUNI
SCE	EDMONS_2_NSPIN	25607	EDMON3AP	14.4	16.86	4	BC/Ventura	Big Creek	Pumps	MUNI
SCE	EDMONS_2_NSPIN	25608	EDMON4AP	14.4	16.86	5	BC/Ventura	Big Creek	Pumps	MUNI
SCE	EDMONS_2_NSPIN	25608	EDMON4AP	14.4	16.86	6	BC/Ventura	Big Creek	Pumps	MUNI
SCE	EDMONS_2_NSPIN	25609	EDMON5AP	14.4	16.86	7	BC/Ventura	Big Creek	Pumps	MUNI
SCE	EDMONS_2_NSPIN	25609	EDMON5AP	14.4	16.86	8	BC/Ventura	Big Creek	Pumps	MUNI
SCE	EDMONS_2_NSPIN	25610	EDMON6AP	14.4	16.86	9	BC/Ventura	Big Creek	Pumps	MUNI
SCE	EDMONS_2_NSPIN	25610	EDMON6AP	14.4	16.86	10	BC/Ventura	Big Creek	Pumps	MUNI
SCE	EDMONS_2_NSPIN	25611	EDMON7AP	14.4	16.85	11	BC/Ventura	Big Creek	Pumps	MUNI
SCE	EDMONS_2_NSPIN	25611	EDMON7AP	14.4	16.85	12	BC/Ventura	Big Creek	Pumps	MUNI
SCE	EDMONS_2_NSPIN	25612	EDMON8AP	14.4	16.85	13	BC/Ventura	Big Creek	Pumps	MUNI
SCE	EDMONS_2_NSPIN	25612	EDMON8AP	14.4	16.85	14	BC/Ventura	Big Creek	Pumps	MUNI
SCE	GLDFGR_6_SOLAR1	25079	PRIDE B G	0.64	8.20	1	BC/Ventura	Big Creek	Aug NQC	Market
SCE	GLDFGR_6_SOLAR2	25169	PRIDE C G	0.64	4.67	1	BC/Ventura	Big Creek	Aug NQC	Market
SCE	GLOW_6_SOLAR	29896	APPINV	0.42	0.00	EQ	BC/Ventura	Big Creek	Energy Only	Market
SCE	GOLETA_2_QF	24057	GOLETA	66	0.05		BC/Ventura	Ventura, S.Clara, Moorpark, Goleta	Not modeled Aug NQC	QF/Selfgen
SCE	GOLETA_6_ELLWOD	29004	ELLWOOD	13.8	0.00	1	BC/Ventura	Ventura, S.Clara, Moorpark, Goleta	Retirement requested effective date January 1, 2019	Market
SCE	GOLETA_6_EXGEN	24362	EXGEN2	13.8	4.10	G1	BC/Ventura	Ventura, S.Clara, Moorpark, Goleta	Aug NQC - Currently out of service	QF/Selfgen
SCE	GOLETA_6_EXGEN	24326	EXGEN1	13.8	2.83	S1	BC/Ventura	Ventura, S.Clara, Moorpark, Goleta	Aug NQC - Currently out of service	QF/Selfgen

Attachment A - List of physical resources by PTO, local area and market ID

SCE	GOLETA_6_GAVOTA	24057	GOLETA	66	0.26		BC/Ventura	Ventura, S.Clara, Moorpark, Goleta	Not modeled Aug NQC	Market
SCE	GOLETA_6_TAJIGS	24057	GOLETA	66	2.84		BC/Ventura	Ventura, S.Clara, Moorpark, Goleta	Not modeled Aug NQC	Market
SCE	LEBECS_2_UNITS	29051	PSTRIAG1	18	165.58	G1	BC/Ventura	Big Creek	Aug NQC	Market
SCE	LEBECS_2_UNITS	29052	PSTRIAG2	18	165.58	G2	BC/Ventura	Big Creek	Aug NQC	Market
SCE	LEBECS_2_UNITS	29054	PSTRIAG3	18	165.58	G3	BC/Ventura	Big Creek	Aug NQC	Market
SCE	LEBECS_2_UNITS	29053	PSTRIAS1	18	170.45	S1	BC/Ventura	Big Creek	Aug NQC	Market
SCE	LEBECS_2_UNITS	29055	PSTRIAS2	18	82.79	S2	BC/Ventura	Big Creek	Aug NQC	Market
SCE	LITLRK_6_SEPV01				0.00		BC/Ventura	Big Creek	Not modeled Energy Only	Market
SCE	LITLRK_6_SOLAR1				2.05		BC/Ventura	Big Creek	Not modeled Aug NQC	Market
SCE	LITLRK_6_SOLAR2				0.82		BC/Ventura	Big Creek	Not modeled Aug NQC	Market
SCE	LITLRK_6_SOLAR4				1.23		BC/Ventura	Big Creek	Not modeled Aug NQC	Market
SCE	LNCSTR_6_CREST				0.00		BC/Ventura	Big Creek	Not modeled Energy Only	Market
SCE	MNDALY_6_MCGRTH	29306	MCGPKGEN	13.8	47.20	1	BC/Ventura	Ventura, S.Clara, Moorpark		Market
SCE	MOORPK_2_CALABS	25081	WDT251	13.8	5.40	EQ	BC/Ventura	Ventura, Moorpark	Aug NQC	Market
SCE	MOORPK_6_QF	29952	CAMGEN	13.8	26.42	D1	BC/Ventura	Ventura, S.Clara, Moorpark	Aug NQC	Market
SCE	MOORPK_7_UNITA1	24098	MOORPARK	66	2.12		BC/Ventura	Ventura, Moorpark	Not modeled Aug NQC	Market
SCE	NEENCH_6_SOLAR	29900	ALPINE_G	0.48	27.06	EQ	BC/Ventura	Big Creek	Aug NQC	Market
SCE	OASIS_6_CREST				0.00		BC/Ventura	Big Creek	Not modeled Energy Only	Market
SCE	OASIS_6_SOLAR1	25095	SOLARISG2	0.2	0.00	EQ	BC/Ventura	Big Creek	Not modeled Energy Only	Market
SCE	OASIS_6_SOLAR2	25075	SOLARISG	0.2	8.20	EQ	BC/Ventura	Big Creek	Aug NQC	Market
SCE	OASIS_6_SOLAR3				0.00		BC/Ventura	Big Creek	Not modeled Energy Only	Market
SCE	OMAR_2_UNIT 1	24102	OMAR 1G	13.8	72.80	1	BC/Ventura	Big Creek		Net Seller
SCE	OMAR_2_UNIT 2	24103	OMAR 2G	13.8	74.00	2	BC/Ventura	Big Creek		Net Seller
SCE	OMAR_2_UNIT 3	24104	OMAR 3G	13.8	75.90	3	BC/Ventura	Big Creek		Net Seller

Attachment A - List of physical resources by PTO, local area and market ID

SCE	OMAR_2_UNIT 4	24105	OMAR 4G	13.8	81.44	4	BC/Ventura	Big Creek		Net Seller
SCE	ORMOND_7_UNIT 1	24107	ORMOND1G	26	0.00	1	BC/Ventura	Ventura, Moorpark	Retirement requested effective date October 1, 2018	Market
SCE	ORMOND_7_UNIT 2	24108	ORMOND2G	26	0.00	2	BC/Ventura	Ventura, Moorpark	Retirement requested effective date October 1, 2018	Market
SCE	OSO_6_NSPIN	25614	OSO A P	13.2	2.25	1	BC/Ventura	Big Creek	Pumps	MUNI
SCE	OSO_6_NSPIN	25614	OSO A P	13.2	2.25	2	BC/Ventura	Big Creek	Pumps	MUNI
SCE	OSO_6_NSPIN	25614	OSO A P	13.2	2.25	3	BC/Ventura	Big Creek	Pumps	MUNI
SCE	OSO_6_NSPIN	25614	OSO A P	13.2	2.25	4	BC/Ventura	Big Creek	Pumps	MUNI
SCE	OSO_6_NSPIN	25615	OSO B P	13.2	2.25	5	BC/Ventura	Big Creek	Pumps	MUNI
SCE	OSO_6_NSPIN	25615	OSO B P	13.2	2.25	6	BC/Ventura	Big Creek	Pumps	MUNI
SCE	OSO_6_NSPIN	25615	OSO B P	13.2	2.25	7	BC/Ventura	Big Creek	Pumps	MUNI
SCE	OSO_6_NSPIN	25615	OSO B P	13.2	2.25	8	BC/Ventura	Big Creek	Pumps	MUNI
SCE	PANDOL_6_UNIT	24113	PANDOL	13.8	23.32	1	BC/Ventura	Big Creek, Vestal	Aug NQC	Market
SCE	PANDOL_6_UNIT	24113	PANDOL	13.8	23.32	2	BC/Ventura	Big Creek, Vestal	Aug NQC	Market
SCE	PLAINV_6_BSOLAR	29917	SSOLAR)GR WKS	0.8	0.00	1	BC/Ventura	Big Creek	Energy Only	Market
SCE	PLAINV_6_DSOLAR	29914	WADR_PV	0.42	4.10	1	BC/Ventura	Big Creek	Aug NQC	Market
SCE	PLAINV_6_NLRSR1	29921	NLR_INVTR	0.42	0.00	1	BC/Ventura	Big Creek	Aug NQC	Market
SCE	PLAINV_6_SOLAR3	25089	CNTRL ANT G	0.42	0.00	1	BC/Ventura	Big Creek	Energy Only	Market
SCE	PLAINV_6_SOLARC	25086	SIRA SOLAR G	0.8	0.00	1	BC/Ventura	Big Creek	Energy Only	Market
SCE	PMDLET_6_SOLAR1				4.10		BC/Ventura	Big Creek	Not modeled Aug NQC	Market
SCE	RECTOR_2_CREST	24212	RECTOR	66	0.00		BC/Ventura	Big Creek, Rector, Vestal	Not modeled Aug NQC	Market
SCE	RECTOR_2_KAWEAH	24370	KAWGEN	13.8	0.03	1	BC/Ventura	Big Creek, Rector, Vestal	Aug NQC	Market
SCE	RECTOR_2_KAWH 1	24370	KAWGEN	13.8	0.19	1	BC/Ventura	Big Creek, Rector, Vestal	Aug NQC	Market
SCE	RECTOR_2_QF	24212	RECTOR	66	0.07		BC/Ventura	Big Creek, Rector, Vestal	Not modeled Aug NQC	QF/Selfgen

Attachment A - List of physical resources by PTO, local area and market ID

SCE	RECTOR_7_TULARE	24212	RECTOR	66	0.00		BC/Ventura	Big Creek, Rector, Vestal	Not modeled	Market
SCE	REDMAN_2_SOLAR				1.54		BC/Ventura	Big Creek	Not modeled Aug NQC	Market
SCE	ROSMND_6_SOLAR				1.23		BC/Ventura	Big Creek	Not modeled Aug NQC	Market
SCE	RSMSLR_6_SOLAR1	29984	DAWNGEN	0.8	8.20	EQ	BC/Ventura	Big Creek	Aug NQC	Market
SCE	RSMSLR_6_SOLAR2	29888	TWILGHTG	0.8	8.20	EQ	BC/Ventura	Big Creek	Aug NQC	Market
SCE	SAUGUS_2_TOLAND	24135	SAUGUS	66	0.00		BC/Ventura	Big Creek	Not modeled Energy Only	Market
SCE	SAUGUS_6_MWDFTH	24135	SAUGUS	66	7.40		BC/Ventura	Big Creek	Not modeled Aug NQC	MUNI
SCE	SAUGUS_6_PTCHGN	24118	PITCHGEN	13.8	19.91	D1	BC/Ventura	Big Creek	Aug NQC	MUNI
SCE	SAUGUS_6_QF	24135	SAUGUS	66	0.62		BC/Ventura	Big Creek	Not modeled Aug NQC	QF/Selfgen
SCE	SAUGUS_7_CHIQCN	24135	SAUGUS	66	5.61		BC/Ventura	Big Creek	Not modeled Aug NQC	Market
SCE	SAUGUS_7_LOPEZ	24135	SAUGUS	66	5.34		BC/Ventura	Big Creek	Not modeled Aug NQC	QF/Selfgen
SCE	SHUTLE_6_CREST				0.00		BC/Ventura	Big Creek	Not modeled Energy Only	Market
SCE	SNCLRA_2_HOWLNG	25080	GFID8045	13.8	7.63	EQ	BC/Ventura	Ventura, S.Clara, Moorpark	Aug NQC	Market
SCE	SNCLRA_2_SPRHYD				0.38		BC/Ventura	Ventura, S.Clara, Moorpark	Not modeled Aug NQC	Market
SCE	SNCLRA_2_UNIT1	24159	WILLAMET	3.8	19.03	D1	BC/Ventura	Ventura, S.Clara, Moorpark	Aug NQC	Market
SCE	SNCLRA_6_OXGEN	24110	OXGEN	13.8	34.10	D1	BC/Ventura	Ventura, S.Clara, Moorpark	Aug NQC	QF/Selfgen
SCE	SNCLRA_6_PROCGN	24119	PROCGEN	13.8	45.74	D1	BC/Ventura	Ventura, S.Clara, Moorpark	Aug NQC	Market
SCE	SNCLRA_6_QF				0.00		BC/Ventura	Ventura, S.Clara, Moorpark	Not modeled Aug NQC	QF/Selfgen
SCE	SPRGVL_2_CREST	24215	SPRINGVL	66	0.00		BC/Ventura	Big Creek, Rector, Vestal	Not modeled Energy Only	Market
SCE	SPRGVL_2_QF	24215	SPRINGVL	66	0.12		BC/Ventura	Big Creek, Rector, Vestal	Not modeled Aug NQC	QF/Selfgen

Attachment A - List of physical resources by PTO, local area and market ID

SCE	SPRGVL_2_TULE	24215	SPRINGVL	66	0.00		BC/Ventura	Big Creek, Rector, Vestal	Not modeled Aug NQC	Market
SCE	SPRGVL_2_TULESC	24215	SPRINGVL	66	0.03		BC/Ventura	Big Creek, Rector, Vestal	Not modeled Aug NQC	Market
SCE	SUNSHN_2_LNDFL	29954	WDT273	13.7	3.33	1	BC/Ventura	Big Creek	Aug NQC	Market
SCE	SUNSHN_2_LNDFL	29954	WDT273	13.7	3.33	2	BC/Ventura	Big Creek	Aug NQC	Market
SCE	SUNSHN_2_LNDFL	29954	WDT273	13.7	3.33	3	BC/Ventura	Big Creek	Aug NQC	Market
SCE	SUNSHN_2_LNDFL	29954	WDT273	13.7	3.33	4	BC/Ventura	Big Creek	Aug NQC	Market
SCE	SUNSHN_2_LNDFL	29954	WDT273	13.7	3.33	5	BC/Ventura	Big Creek	Aug NQC	Market
SCE	SYCAMR_2_UNIT 1	24143	SYCCYN1G	13.8	85.00	1	BC/Ventura	Big Creek	Aug NQC	Net Seller
SCE	SYCAMR_2_UNIT 2	24144	SYCCYN2G	13.8	85.00	2	BC/Ventura	Big Creek	Aug NQC	Net Seller
SCE	SYCAMR_2_UNIT 3	24145	SYCCYN3G	13.8	85.00	3	BC/Ventura	Big Creek	Aug NQC	Net Seller
SCE	SYCAMR_2_UNIT 4	24146	SYCCYN4G	13.8	85.00	4	BC/Ventura	Big Creek	Aug NQC	Net Seller
SCE	TENGEN_2_PL1X2	24148	TENNGEN1	13.8	18.57	D1	BC/Ventura	Big Creek	Aug NQC	Net Seller
SCE	TENGEN_2_PL1X2	24149	TENNGEN2	13.8	18.57	D2	BC/Ventura	Big Creek	Aug NQC	Net Seller
SCE	VESTAL_2_KERN	24372	KR 3-1	11	0.24	1	BC/Ventura	Big Creek, Vestal	Aug NQC	QF/Selfgen
SCE	VESTAL_2_KERN	24373	KR 3-2	11	0.23	2	BC/Ventura	Big Creek, Vestal	Aug NQC	QF/Selfgen
SCE	VESTAL_2_RTS042				0.00		BC/Ventura	Big Creek, Vestal	Not modeled Energy Only	Market
SCE	VESTAL_2_SOLAR1	25066	TULRESLR	0.39	8.20	1	BC/Ventura	Big Creek, Vestal	Aug NQC	Market
SCE	VESTAL_2_SOLAR2	25067	TULRESLR	0.39	1.78	1	BC/Ventura	Big Creek, Vestal	Aug NQC	Market
SCE	VESTAL_2_SOLAR2	25068	TULRESLR	0.36	3.96	1	BC/Ventura	Big Creek, Vestal	Aug NQC	Market
SCE	VESTAL_2_UNIT1				4.39		BC/Ventura	Big Creek, Vestal	Not modeled Aug NQC	Market
SCE	VESTAL_2_WELLHD	24116	WELLGEN	13.8	49.00	1	BC/Ventura	Big Creek, Vestal		Market
SCE	VESTAL_6_QF	29008	LAKEGEN	13.8	1.04	1	BC/Ventura	Big Creek, Vestal	Aug NQC	QF/Selfgen
SCE	WARNE_2_UNIT	25651	WARNE1	13.8	38.00	1	BC/Ventura	Big Creek	Aug NQC	MUNI
SCE	WARNE_2_UNIT	25652	WARNE2	13.8	38.00	2	BC/Ventura	Big Creek	Aug NQC	MUNI
SCE	ZZ_NA	24422	PALMDALE	66	0.00	1	BC/Ventura	Big Creek	No NQC - hist. data	Market
SCE	ZZ_NA	24340	CHARMIN	13.8	2.80	1	BC/Ventura	Ventura, S.Clara, Moorpark	No NQC - hist. data	QF/Selfgen
SCE	ZZ_VESTAL_6_ULTRGN	24150	ULTRAGEN	13.8	0.00	1	BC/Ventura	Big Creek, Vestal	Aug NQC	QF/Selfgen
SCE	ZZZ_New Unit	25171	PRIDE A G	0.64	4.10	1	BC/Ventura	Big Creek	No NQC - est. data	Market

Attachment A - List of physical resources by PTO, local area and market ID

SCE	ZZZ_New Unit	25170	PRIDE A G2	0.64	4.10	1	BC/Ventura	Big Creek	No NQC - est. data	Market
SCE	ZZZZZ_APPGEN_6_UNIT 1	24009	APPGEN1G	13.8	0.00	1	BC/Ventura	Big Creek	Retired	Market
SCE	ZZZZZ_APPGEN_6_UNIT 1	24010	APPGEN2G	13.8	0.00	2	BC/Ventura	Big Creek	Retired	Market
SCE	ZZZZZ_APPGEN_6_UNIT 1	24361	APPGEN3G	13.8	0.00	3	BC/Ventura	Big Creek	Retired	Market
SCE	ZZZZZ_MNDALY_7_UNIT 1	24089	MANDLY1G	13.8	0.00	1	BC/Ventura	Ventura, S.Clara, Moorpark	Retired	Market
SCE	ZZZZZ_MNDALY_7_UNIT 2	24090	MANDLY2G	13.8	0.00	2	BC/Ventura	Ventura, S.Clara, Moorpark	Retired	Market
SCE	ZZZZZ_MNDALY_7_UNIT 3	24222	MANDLY3G	16	0.00	3	BC/Ventura	Ventura, S.Clara, Moorpark	Retired	Market
SCE	ZZZZZ_SNCLRA_6_WILL MT	24159	WILLAMET	13.8	0.00	D1	BC/Ventura	Ventura, S.Clara, Moorpark	Replaced by SNCLRA_2_UNIT1	QF/Selfgen
SCE	ALAMIT_7_UNIT 1	24001	ALAMT1 G	18	0.00	1	LA Basin	Western	Retired by 2021	Market
SCE	ALAMIT_7_UNIT 2	24002	ALAMT2 G	18	0.00	2	LA Basin	Western	Retired by 2021	Market
SCE	ALAMIT_7_UNIT 3	24003	ALAMT3 G	18	0.00	3	LA Basin	Western	Retired by 2021	Market
SCE	ALAMIT_7_UNIT 4	24004	ALAMT4 G	18	0.00	4	LA Basin	Western	Retired by 2021	Market
SCE	ALAMIT_7_UNIT 5	24005	ALAMT5 G	20	0.00	5	LA Basin	Western	Retired by 2021	Market
SCE	ALAMIT_7_UNIT 6	24161	ALAMT6 G	20	0.00	6	LA Basin	Western	Retired by 2021	Market
SCE	ALTWD_1_QF	25635	ALTWIND	115	6.23	Q1	LA Basin	Eastern, Valley-Devers	Aug NQC	QF/Selfgen
SCE	ALTWD_1_QF	25635	ALTWIND	115	6.23	Q2	LA Basin	Eastern, Valley-Devers	Aug NQC	QF/Selfgen
SCE	ANAHM_2_CANYN1	25211	CanyonGT 1	13.8	49.40	1	LA Basin	Western		MUNI
SCE	ANAHM_2_CANYN2	25212	CanyonGT 2	13.8	48.00	2	LA Basin	Western		MUNI
SCE	ANAHM_2_CANYN3	25213	CanyonGT 3	13.8	48.00	3	LA Basin	Western		MUNI
SCE	ANAHM_2_CANYN4	25214	CanyonGT 4	13.8	49.40	4	LA Basin	Western		MUNI
SCE	ANAHM_7_CT	25208	DowlingCTG	13.8	40.64	1	LA Basin	Western	Aug NQC	MUNI
SCE	ARCOGN_2_UNITS	24011	ARCO 1G	13.8	57.40	1	LA Basin	Western	Aug NQC	Net Seller

Attachment A - List of physical resources by PTO, local area and market ID

SCE	ARCOGN_2_UNITS	24012	ARCO 2G	13.8	57.40	2	LA Basin	Western	Aug NQC	Net Seller
SCE	ARCOGN_2_UNITS	24013	ARCO 3G	13.8	57.40	3	LA Basin	Western	Aug NQC	Net Seller
SCE	ARCOGN_2_UNITS	24014	ARCO 4G	13.8	57.40	4	LA Basin	Western	Aug NQC	Net Seller
SCE	ARCOGN_2_UNITS	24163	ARCO 5G	13.8	28.70	5	LA Basin	Western	Aug NQC	Net Seller
SCE	ARCOGN_2_UNITS	24164	ARCO 6G	13.8	28.70	6	LA Basin	Western	Aug NQC	Net Seller
SCE	BARRE_2_QF	24016	BARRE	230	0.00		LA Basin	Western	Not modeled	QF/Selfgen
SCE	BARRE_6_PEAKE	29309	BARPKGEN	13.8	47.00	1	LA Basin	Western		Market
SCE	BLAST_1_WIND	24839	BLAST	115	12.99	1	LA Basin	Eastern, Valley-Devers	Aug NQC	Wind
SCE	BUCKWD_1_NPALM1	25634	BUCKWIND	115	0.98		LA Basin	Eastern, Valley-Devers	Not modeled Aug NQC	Wind
SCE	BUCKWD_1_QF	25634	BUCKWIND	115	4.37	QF	LA Basin	Eastern, Valley-Devers	Aug NQC	QF/Selfgen
SCE	BUCKWD_7_WINTCV	25634	BUCKWIND	115	0.35	W5	LA Basin	Eastern, Valley-Devers	Aug NQC	Wind
SCE	CABZON_1_WINDA1	29290	CABAZON	33	10.87	1	LA Basin	Eastern, Valley-Devers	Aug NQC	Wind
SCE	CAPWD_1_QF	25633	CAPWIND	115	5.18	QF	LA Basin	Eastern, Valley-Devers	Aug NQC	QF/Selfgen
SCE	CENTER_2_QF	29953	SIGGEN	13.8	18.20	D1	LA Basin	Western	Aug NQC	QF/Selfgen
SCE	CENTER_2_RHONDO	24203	CENTER S	66	1.91		LA Basin	Western	Not modeled	QF/Selfgen
SCE	CENTER_2_SOLAR1				0.00		LA Basin	Western	Not modeled Energy Only	Market
SCE	CENTER_6_PEAKE	29308	CTRPKGEN	13.8	47.00	1	LA Basin	Western		Market
SCE	CENTRY_6_PL1X4	25302	CLTNCTRY	13.8	36.00	1	LA Basin	Eastern, Eastern Metro	Aug NQC	MUNI
SCE	CHEVMN_2_UNITS	24022	CHEVGEN1	13.8	5.50	1	LA Basin	Western, El Nido	Aug NQC	Net Seller
SCE	CHEVMN_2_UNITS	24023	CHEVGEN2	13.8	5.50	2	LA Basin	Western, El Nido	Aug NQC	Net Seller
SCE	CHINO_2_APEBT1	25180	WDT1250BES S_	0.48	20.00	1	LA Basin	Eastern, Eastern Metro	Aug NQC	Market
SCE	CHINO_2_JURUPA				0.00		LA Basin	Eastern, Eastern Metro	Not modeled Energy Only	Market
SCE	CHINO_2_QF				0.47		LA Basin	Eastern, Eastern Metro	Not modeled Aug NQC	QF/Selfgen
SCE	CHINO_2_SASOLR				0.00		LA Basin	Eastern, Eastern Metro	Not modeled Energy Only	Market

Attachment A - List of physical resources by PTO, local area and market ID

SCE	CHINO_2_SOLAR				0.41		LA Basin	Eastern, Eastern Metro	Not modeled	Market
SCE	CHINO_2_SOLAR2				0.00		LA Basin	Eastern, Eastern Metro	Not modeled Energy Only	Market
SCE	CHINO_6_CIMGEN	24026	CIMGEN	13.8	25.96	D1	LA Basin	Eastern, Eastern Metro	Aug NQC	QF/Selfgen
SCE	CHINO_6_SMPPAP	24140	SIMPSON	13.8	22.78	D1	LA Basin	Eastern, Eastern Metro	Aug NQC	QF/Selfgen
SCE	CHINO_7_MILIKN	24024	CHINO	66	1.19		LA Basin	Eastern, Eastern Metro	Not modeled Aug NQC	Market
SCE	COLTON_6_AGUAM1	25303	CLTNAGUA	13.8	43.00	1	LA Basin	Eastern, Eastern Metro	Aug NQC	MUNI
SCE	CORONS_2_SOLAR				0.00		LA Basin	Eastern, Eastern Metro	Not modeled Energy Only	Market
SCE	CORONS_6_CLRWTR	29338	CLRWTRCT	13.8	20.72	G1	LA Basin	Eastern, Eastern Metro		MUNI
SCE	CORONS_6_CLRWTR	29340	CLRWTRST	13.8	7.28	S1	LA Basin	Eastern, Eastern Metro		MUNI
SCE	DELAMO_2_SOLAR1				0.62		LA Basin	Western	Not modeled Aug NQC	Market
SCE	DELAMO_2_SOLAR2				0.72		LA Basin	Western	Not modeled Aug NQC	Market
SCE	DELAMO_2_SOLAR3				0.51		LA Basin	Western	Not modeled Aug NQC	Market
SCE	DELAMO_2_SOLAR4				0.53		LA Basin	Western	Not modeled Aug NQC	Market
SCE	DELAMO_2_SOLAR5				0.41		LA Basin	Western	Not modeled Aug NQC	Market
SCE	DELAMO_2_SOLAR6				0.82		LA Basin	Western	Not modeled Aug NQC	Market
SCE	DELAMO_2_SOLRC1				0.00		LA Basin	Western	Not modeled Energy Only	Market
SCE	DELAMO_2_SOLRD				0.00		LA Basin	Western	Not modeled Energy Only	Market
SCE	DEVERS_1_QF	25632	TERAWND	115	8.63	QF	LA Basin	Eastern, Valley-Devers	Aug NQC	QF/Selfgen
SCE	DEVERS_1_QF	25639	SEAWIND	115	10.35	QF	LA Basin	Eastern, Valley-Devers	Aug NQC	QF/Selfgen

Attachment A - List of physical resources by PTO, local area and market ID

SCE	DEVERS_1_SEPV05				0.00		LA Basin	Eastern, Valley-Devers	Not modeled Energy Only	Market
SCE	DEVERS_1_SOLAR				0.00		LA Basin	Eastern, Valley-Devers	Not modeled Energy Only	Market
SCE	DEVERS_1_SOLAR1				0.00		LA Basin	Eastern, Valley-Devers	Not modeled Energy Only	Market
SCE	DEVERS_1_SOLAR2				0.00		LA Basin	Eastern, Valley-Devers	Not modeled Energy Only	Market
SCE	DEVERS_2_DHSPG2				0.00		LA Basin	Eastern, Valley-Devers	Not modeled Energy Only	Market
SCE	DMDVLY_1_UNITS	25425	ESRP P2	6.9	0.00	8	LA Basin	Eastern, Eastern Metro	Aug NQC	QF/Selfgen
SCE	DREWS_6_PL1X4	25301	CLTNDREW	13.8	36.00	1	LA Basin	Eastern, Eastern Metro	Aug NQC	MUNI
SCE	DVLCYN_1_UNITS	25648	DVLCYN1G	13.8	50.35	1	LA Basin	Eastern, Eastern Metro	Aug NQC	MUNI
SCE	DVLCYN_1_UNITS	25649	DVLCYN2G	13.8	50.35	2	LA Basin	Eastern, Eastern Metro	Aug NQC	MUNI
SCE	DVLCYN_1_UNITS	25603	DVLCYN3G	13.8	67.13	3	LA Basin	Eastern, Eastern Metro	Aug NQC	MUNI
SCE	DVLCYN_1_UNITS	25604	DVLCYN4G	13.8	67.13	4	LA Basin	Eastern, Eastern Metro	Aug NQC	MUNI
SCE	ELLIS_2_QF	24325	ORCOGEN	13.8	0.03	1	LA Basin	Western	Aug NQC	QF/Selfgen
SCE	ELSEGN_2_UN1011	29904	ELSEG5GT	16.5	131.50	5	LA Basin	Western, El Nido	Aug NQC	Market
SCE	ELSEGN_2_UN1011	29903	ELSEG6ST	13.8	131.50	6	LA Basin	Western, El Nido	Aug NQC	Market
SCE	ELSEGN_2_UN2021	29902	ELSEG7GT	16.5	131.84	7	LA Basin	Western, El Nido	Aug NQC	Market
SCE	ELSEGN_2_UN2021	29901	ELSEG8ST	13.8	131.84	8	LA Basin	Western, El Nido	Aug NQC	Market
SCE	ETIWND_2_CHMPNE				0.00		LA Basin	Eastern, Eastern Metro	Not modeled Energy Only	Market
SCE	ETIWND_2_FONTNA	24055	ETIWANDA	66	0.11		LA Basin	Eastern, Eastern Metro	Not modeled Aug NQC	QF/Selfgen
SCE	ETIWND_2_RTS010	24055	ETIWANDA	66	0.62		LA Basin	Eastern, Eastern Metro	Not modeled Aug NQC	Market
SCE	ETIWND_2_RTS015	24055	ETIWANDA	66	1.23		LA Basin	Eastern, Eastern Metro	Not modeled Aug NQC	Market
SCE	ETIWND_2_RTS017	24055	ETIWANDA	66	1.44		LA Basin	Eastern, Eastern Metro	Not modeled Aug NQC	Market

Attachment A - List of physical resources by PTO, local area and market ID

SCE	ETIWND_2_RTS018	24055	ETIWANDA	66	0.62		LA Basin	Eastern, Eastern Metro	Not modeled Aug NQC	Market
SCE	ETIWND_2_RTS023	24055	ETIWANDA	66	1.03		LA Basin	Eastern, Eastern Metro	Not modeled Aug NQC	Market
SCE	ETIWND_2_RTS026	24055	ETIWANDA	66	2.46		LA Basin	Eastern, Eastern Metro	Not modeled Aug NQC	Market
SCE	ETIWND_2_RTS027	24055	ETIWANDA	66	0.82		LA Basin	Eastern, Eastern Metro	Not modeled Aug NQC	Market
SCE	ETIWND_2_SOLAR1				0.00		LA Basin	Eastern, Eastern Metro	Not modeled Energy Only	Market
SCE	ETIWND_2_SOLAR2				0.00		LA Basin	Eastern, Eastern Metro	Not modeled Energy Only	Market
SCE	ETIWND_2_SOLAR5				0.00		LA Basin	Eastern, Eastern Metro	Not modeled Energy Only	Market
SCE	ETIWND_2_UNIT1	24071	INLAND	13.8	23.36	1	LA Basin	Eastern, Eastern Metro	Aug NQC	QF/Selfgen
SCE	ETIWND_6_GRPLND	29305	ETWPKGEN	13.8	46.00	1	LA Basin	Eastern, Eastern Metro		Market
SCE	ETIWND_6_MWDETI	25422	ETI MWDG	13.8	2.80	1	LA Basin	Eastern, Eastern Metro	Aug NQC	Market
SCE	ETIWND_7_MIDVLY	24055	ETIWANDA	66	1.67		LA Basin	Eastern, Eastern Metro	Not modeled Aug NQC	QF/Selfgen
SCE	GARNET_1_SOLAR	24815	GARNET	115	0.00		LA Basin	Eastern, Valley-Devers	Not modeled Energy Only	Market
SCE	GARNET_1_SOLAR2	24815	GARNET	115	1.64		LA Basin	Eastern, Valley-Devers	Not modeled Aug NQC	Market
SCE	GARNET_1_UNITS	24815	GARNET	115	2.06	G1	LA Basin	Eastern, Valley-Devers	Aug NQC	Market
SCE	GARNET_1_UNITS	24815	GARNET	115	0.71	G2	LA Basin	Eastern, Valley-Devers	Aug NQC	Market
SCE	GARNET_1_UNITS	24815	GARNET	115	1.61	G3	LA Basin	Eastern, Valley-Devers	Aug NQC	Market
SCE	GARNET_1_WIND	24815	GARNET	115	1.72		LA Basin	Eastern, Valley-Devers	Not modeled Aug NQC	Wind
SCE	GARNET_1_WINDS	24815	GARNET	115	5.96	W2	LA Basin	Eastern, Valley-Devers	Aug NQC	Wind
SCE	GARNET_1_WT3WND	24815	GARNET	115	0.00	W3	LA Basin	Eastern, Valley-Devers	Aug NQC	Market

Attachment A - List of physical resources by PTO, local area and market ID

SCE	GARNET_2_HYDRO	24815	GARNET	115	0.54	QF	LA Basin	Eastern, Valley-Devers	Aug NQC	Market
SCE	GARNET_2_WIND1	24815	GARNET	115	2.97		LA Basin	Eastern, Valley-Devers	Not modeled Aug NQC	Wind
SCE	GARNET_2_WIND2	24815	GARNET	115	3.10		LA Basin	Eastern, Valley-Devers	Not modeled Aug NQC	Wind
SCE	GARNET_2_WIND3	24815	GARNET	115	3.34		LA Basin	Eastern, Valley-Devers	Not modeled Aug NQC	Wind
SCE	GARNET_2_WIND4	24815	GARNET	115	2.60		LA Basin	Eastern, Valley-Devers	Not modeled Aug NQC	Wind
SCE	GARNET_2_WIND5	24815	GARNET	115	0.80		LA Basin	Eastern, Valley-Devers	Not modeled Aug NQC	Wind
SCE	GLNARM_2_UNIT 5	29013	GLENARM5_CT	13.8	50.00	CT	LA Basin	Western		MUNI
SCE	GLNARM_2_UNIT 5	29014	GLENARM5_S T	13.8	15.00	ST	LA Basin	Western		MUNI
SCE	GLNARM_7_UNIT 1	29005	PASADNA1	13.8	22.07	1	LA Basin	Western		MUNI
SCE	GLNARM_7_UNIT 2	29006	PASADNA2	13.8	22.30	1	LA Basin	Western		MUNI
SCE	GLNARM_7_UNIT 3	25042	PASADNA3	13.8	44.83	1	LA Basin	Western		MUNI
SCE	GLNARM_7_UNIT 4	25043	PASADNA4	13.8	42.42	1	LA Basin	Western		MUNI
SCE	HARBGN_7_UNITS	24062	HARBOR G	13.8	76.27	1	LA Basin	Western	Mothballed	Market
SCE	HARBGN_7_UNITS	24062	HARBOR G	13.8	11.86	HP	LA Basin	Western	Mothballed	Market
SCE	HARBGN_7_UNITS	25510	HARBORG4	4.16	11.86	LP	LA Basin	Western	Mothballed	Market
SCE	HINSON_6_CARBG N	24020	CARBGEN1	13.8	14.83	1	LA Basin	Western	Aug NQC	Market
SCE	HINSON_6_CARBG N	24328	CARBGEN2	13.8	14.83	1	LA Basin	Western	Aug NQC	Market
SCE	HINSON_6_LBECH1	24170	LBEACH12	13.8	65.00	1	LA Basin	Western		Market
SCE	HINSON_6_LBECH2	24170	LBEACH12	13.8	65.00	2	LA Basin	Western		Market
SCE	HINSON_6_LBECH3	24171	LBEACH34	13.8	65.00	3	LA Basin	Western		Market
SCE	HINSON_6_LBECH4	24171	LBEACH34	13.8	65.00	4	LA Basin	Western		Market
SCE	HINSON_6_SERRGN	24139	SERRFGEN	13.8	28.90	D1	LA Basin	Western	Aug NQC	QF/Selfgen
SCE	HNTGBH_7_UNIT 1	24066	HUNT1 G	13.8	0.00	1	LA Basin	Western	Retired by 2021	Market
SCE	HNTGBH_7_UNIT 2	24067	HUNT2 G	13.8	0.00	2	LA Basin	Western	Retired by 2021	Market
SCE	INDIGO_1_UNIT 1	29190	WINTECX2	13.8	42.00	1	LA Basin	Eastern, Valley-Devers		Market

Attachment A - List of physical resources by PTO, local area and market ID

SCE	INDIGO_1_UNIT 2	29191	WINTECX1	13.8	42.00	1	LA Basin	Eastern, Valley-Devers		Market
SCE	INDIGO_1_UNIT 3	29180	WINTEC8	13.8	42.00	1	LA Basin	Eastern, Valley-Devers		Market
SCE	INLDEM_5_UNIT 1	29041	IIEEC-G1	19.5	335.00	1	LA Basin	Eastern, Valley, Valley-Devers	Aug NQC	Market
SCE	INLDEM_5_UNIT 2	29042	IIEEC-G2	19.5	335.00	1	LA Basin	Eastern, Valley, Valley-Devers	Mothballed	Market
SCE	LACIEN_2_VENICE	24337	VENICE	13.8	0.00	1	LA Basin	Western, El Nido	Aug NQC	MUNI
SCE	LAGBEL_2_STG1				9.60		LA Basin	Western	Not modeled Aug NQC	Market
SCE	LAGBEL_6_QF	29951	REFUSE	13.8	0.29	D1	LA Basin	Western	Aug NQC	QF/Selfgen
SCE	LGHTHP_6_ICEGEN	24070	ICEGEN	13.8	48.00	1	LA Basin	Western	Aug NQC	QF/Selfgen
SCE	MESAS_2_QF	24209	MESA CAL	66	0.00		LA Basin	Western	Not modeled Aug NQC	QF/Selfgen
SCE	MIRLOM_2_CORONA				2.23		LA Basin	Eastern, Eastern Metro	Not modeled Aug NQC	QF/Selfgen
SCE	MIRLOM_2_LNDFL				1.23		LA Basin	Eastern, Eastern Metro	Not modeled Aug NQC	Market
SCE	MIRLOM_2_MLBBTA	25185	WDT1425_G1	0.48	10.00	1	LA Basin	Eastern, Eastern Metro	Aug NQC	Market
SCE	MIRLOM_2_MLBBTB	25186	WDT1426_G2	0.48	10.00	1	LA Basin	Eastern, Eastern Metro	Aug NQC	Market
SCE	MIRLOM_2_ONTARO				2.26		LA Basin	Eastern, Eastern Metro	Not modeled Aug NQC	Market
SCE	MIRLOM_2_RTS032				0.62		LA Basin	Eastern, Eastern Metro	Not modeled Aug NQC	Market
SCE	MIRLOM_2_RTS033				0.41		LA Basin	Eastern, Eastern Metro	Not modeled Aug NQC	Market
SCE	MIRLOM_2_TEMESC				1.65		LA Basin	Eastern, Eastern Metro	Not modeled Aug NQC	QF/Selfgen
SCE	MIRLOM_6_DELGEN	29339	DELGEN	13.8	25.93	1	LA Basin	Eastern, Eastern Metro	Aug NQC	QF/Selfgen
SCE	MIRLOM_6_PEAKER	29307	MRLPKGEN	13.8	46.00	1	LA Basin	Eastern, Eastern Metro		Market
SCE	MIRLOM_7_MWDLKM	24210	MIRALOMA	66	4.80		LA Basin	Eastern, Eastern Metro	Not modeled Aug NQC	MUNI

Attachment A - List of physical resources by PTO, local area and market ID

SCE	MOJAVE_1_SIPHON	25657	MJVSPHN1	13.8	4.79	1	LA Basin	Eastern, Eastern Metro	Aug NQC	Market
SCE	MOJAVE_1_SIPHON	25658	MJVSPHN1	13.8	4.79	2	LA Basin	Eastern, Eastern Metro	Aug NQC	Market
SCE	MOJAVE_1_SIPHON	25659	MJVSPHN1	13.8	4.79	3	LA Basin	Eastern, Eastern Metro	Aug NQC	Market
SCE	MTWIND_1_UNIT 1	29060	MOUNTWND	115	11.77	S1	LA Basin	Eastern, Valley-Devers	Aug NQC	Wind
SCE	MTWIND_1_UNIT 2	29060	MOUNTWND	115	5.88	S2	LA Basin	Eastern, Valley-Devers	Aug NQC	Wind
SCE	MTWIND_1_UNIT 3	29060	MOUNTWND	115	5.95	S3	LA Basin	Eastern, Valley-Devers	Aug NQC	Wind
SCE	OLINDA_2_COYCRK	24211	OLINDA	66	3.13		LA Basin	Western	Not modeled	QF/Selfgen
SCE	OLINDA_2_LNDFL2	29011	BREAPWR2	13.8	3.86	C1	LA Basin	Western	Aug NQC	Market
SCE	OLINDA_2_LNDFL2	29011	BREAPWR2	13.8	3.86	C2	LA Basin	Western	Aug NQC	Market
SCE	OLINDA_2_LNDFL2	29011	BREAPWR2	13.8	3.86	C3	LA Basin	Western	Aug NQC	Market
SCE	OLINDA_2_LNDFL2	29011	BREAPWR2	13.8	3.86	C4	LA Basin	Western	Aug NQC	Market
SCE	OLINDA_2_LNDFL2	29011	BREAPWR2	13.8	6.91	S1	LA Basin	Western	Aug NQC	Market
SCE	OLINDA_2_QF	24211	OLINDA	66	0.01		LA Basin	Western	Not modeled Aug NQC	QF/Selfgen
SCE	OLINDA_7_LNDFIL	24211	OLINDA	66	0.00		LA Basin	Western	Not modeled Aug NQC	QF/Selfgen
SCE	PADUA_2_ONTARO	24111	PADUA	66	0.12		LA Basin	Eastern, Eastern Metro	Not modeled Aug NQC	QF/Selfgen
SCE	PADUA_2_SOLAR1	24111	PADUA	66	0.00		LA Basin	Eastern, Eastern Metro	Not modeled Energy Only	Market
SCE	PADUA_6_MWSDSM	24111	PADUA	66	5.51		LA Basin	Eastern, Eastern Metro	Not modeled Aug NQC	MUNI
SCE	PADUA_6_QF	24111	PADUA	66	0.38		LA Basin	Eastern, Eastern Metro	Not modeled Aug NQC	QF/Selfgen
SCE	PADUA_7_SDIMAS	24111	PADUA	66	1.05		LA Basin	Eastern, Eastern Metro	Not modeled Aug NQC	Market
SCE	PANSEA_1_PANARO	25640	PANAERO	115	7.95	QF	LA Basin	Eastern, Valley-Devers	Aug NQC	Wind
SCE	PWEST_1_UNIT	24815	GARNET	115	0.56	PC	LA Basin	Western	Aug NQC	Market
SCE	REDOND_7_UNIT 5	24121	REDON5 G	18	0.00	5	LA Basin	Western	Retired by 2021	Market

Attachment A - List of physical resources by PTO, local area and market ID

SCE	REDOND_7_UNIT 6	24122	REDON6 G	18	0.00	6	LA Basin	Western	Retired by 2021	Market
SCE	REDOND_7_UNIT 7	24123	REDON7 G	20	0.00	7	LA Basin	Western	Retired by 2021	Market
SCE	REDOND_7_UNIT 8	24124	REDON8 G	20	0.00	8	LA Basin	Western	Retired by 2021	Market
SCE	RENWD_1_QF	25636	RENWIND	115	1.33	Q1	LA Basin	Eastern, Valley-Devers	Aug NQC	QF/Selfgen
SCE	RENWD_1_QF	25636	RENWIND	115	1.32	Q2	LA Basin	Eastern, Valley-Devers	Aug NQC	QF/Selfgen
SCE	RHONDO_2_QF	24213	RIOHONDO	66	0.21	DG	LA Basin	Western	Aug NQC	QF/Selfgen
SCE	RHONDO_6_PUENTE	24213	RIOHONDO	66	0.00		LA Basin	Western	Not modeled Aug NQC	Net Seller
SCE	RVSIDE_2_RERCU3	24299	RERC2G3	13.8	48.50	1	LA Basin	Eastern, Eastern Metro		MUNI
SCE	RVSIDE_2_RERCU4	24300	RERC2G4	13.8	48.50	1	LA Basin	Eastern, Eastern Metro		MUNI
SCE	RVSIDE_6_RERCU1	24242	RERC1G	13.8	48.35	1	LA Basin	Eastern, Eastern Metro		MUNI
SCE	RVSIDE_6_RERCU2	24243	RERC2G	13.8	48.50	1	LA Basin	Eastern, Eastern Metro		MUNI
SCE	RVSIDE_6_SOLAR1	24244	SPRINGEN	13.8	3.08		LA Basin	Eastern, Eastern Metro	Not modeled Aug NQC	Market
SCE	RVSIDE_6_SPRING	24244	SPRINGEN	13.8	36.00	1	LA Basin	Eastern, Eastern Metro		Market
SCE	SANITR_6_UNITS	24324	SANIGEN	13.8	2.92	D1	LA Basin	Eastern, Eastern Metro	Aug NQC	QF/Selfgen
SCE	SANTGO_2_LNDFL1	24341	COYGEN	13.8	15.88	1	LA Basin	Western	Aug NQC	Market
SCE	SANTGO_2_MABBT1	25192	WDT1406_G	0.48	2.00	1	LA Basin	Western	Aug NQC	Market
SCE	SANWD_1_QF	25646	SANWIND	115	4.11	Q1	LA Basin	Eastern, Valley-Devers	Aug NQC	Wind
SCE	SANWD_1_QF	25646	SANWIND	115	4.11	Q2	LA Basin	Eastern, Valley-Devers	Aug NQC	Wind
SCE	SBERDO_2_PSP3	24921	MNTV-CT1	18	140.56	1	LA Basin	Eastern, West of Devers, Eastern Metro		Market
SCE	SBERDO_2_PSP3	24922	MNTV-CT2	18	140.56	1	LA Basin	Eastern, West of Devers, Eastern Metro		Market

Attachment A - List of physical resources by PTO, local area and market ID

SCE	SBERDO_2_PSP3	24923	MNTV-ST1	18	243.89	1	LA Basin	Eastern, West of Devers, Eastern Metro		Market
SCE	SBERDO_2_PSP4	24924	MNTV-CT3	18	140.56	1	LA Basin	Eastern, West of Devers, Eastern Metro		Market
SCE	SBERDO_2_PSP4	24925	MNTV-CT4	18	140.56	1	LA Basin	Eastern, West of Devers, Eastern Metro		Market
SCE	SBERDO_2_PSP4	24926	MNTV-ST2	18	243.89	1	LA Basin	Eastern, West of Devers, Eastern Metro		Market
SCE	SBERDO_2_QF	24214	SANBRDNO	66	0.28		LA Basin	Eastern, West of Devers, Eastern Metro	Not modeled Aug NQC	QF/Selfgen
SCE	SBERDO_2_REDLND	24214	SANBRDNO	66	0.82		LA Basin	Eastern, West of Devers, Eastern Metro	Not modeled Aug NQC	Market
SCE	SBERDO_2_RTS005	24214	SANBRDNO	66	1.03		LA Basin	Eastern, West of Devers, Eastern Metro	Not modeled Aug NQC	Market
SCE	SBERDO_2_RTS007	24214	SANBRDNO	66	1.03		LA Basin	Eastern, West of Devers, Eastern Metro	Not modeled Aug NQC	Market
SCE	SBERDO_2_RTS011	24214	SANBRDNO	66	1.44		LA Basin	Eastern, West of Devers, Eastern Metro	Not modeled Aug NQC	Market
SCE	SBERDO_2_RTS013	24214	SANBRDNO	66	1.44		LA Basin	Eastern, West of Devers, Eastern Metro	Not modeled Aug NQC	Market
SCE	SBERDO_2_RTS016	24214	SANBRDNO	66	0.62		LA Basin	Eastern, West of Devers, Eastern Metro	Not modeled Aug NQC	Market
SCE	SBERDO_2_RTS048	24214	SANBRDNO	66	0.00		LA Basin	Eastern, West of Devers, Eastern Metro	Not modeled Energy Only	Market
SCE	SBERDO_2_SNTANA	24214	SANBRDNO	66	0.00		LA Basin	Eastern, West of Devers, Eastern Metro	Not modeled Aug NQC	QF/Selfgen
SCE	SBERDO_6_MILLCK	24214	SANBRDNO	66	0.64		LA Basin	Eastern, West of Devers, Eastern Metro	Not modeled Aug NQC	QF/Selfgen
SCE	SENTNL_2_CTG1	29101	SENTINEL_G1	13.8	92.09	1	LA Basin	Eastern, Valley-Devers		Market

Attachment A - List of physical resources by PTO, local area and market ID

SCE	SENTNL_2_C TG2	29102	SENTINEL_G 2	13.8	92.40	1	LA Basin	Eastern, Valley- Devers		Market
SCE	SENTNL_2_C TG3	29103	SENTINEL_G 3	13.8	92.36	1	LA Basin	Eastern, Valley- Devers		Market
SCE	SENTNL_2_C TG4	29104	SENTINEL_G 4	13.8	91.98	1	LA Basin	Eastern, Valley- Devers		Market
SCE	SENTNL_2_C TG5	29105	SENTINEL_G 5	13.8	91.83	1	LA Basin	Eastern, Valley- Devers		Market
SCE	SENTNL_2_C TG6	29106	SENTINEL_G 6	13.8	92.16	1	LA Basin	Eastern, Valley- Devers		Market
SCE	SENTNL_2_C TG7	29107	SENTINEL_G 7	13.8	91.84	1	LA Basin	Eastern, Valley- Devers		Market
SCE	SENTNL_2_C TG8	29108	SENTINEL_G 8	13.8	91.56	1	LA Basin	Eastern, Valley- Devers		Market
SCE	TIFFNY_1_DILLON	29021	WINTEC6	115	11.93	1	LA Basin	Eastern, Valley- Devers	Aug NQC	Wind
SCE	TRNSWD_1_QF	25637	TRANWIND	115	10.33	QF	LA Basin	Eastern, Valley- Devers	Aug NQC	Wind
SCE	VALLEY_5_PERRIS	24160	VALLEYSC	115	7.94		LA Basin	Eastern, Valley, Valley-Devers	Not modeled Aug NQC	QF/Selfgen
SCE	VALLEY_5_REDMTN	24160	VALLEYSC	115	2.20		LA Basin	Eastern, Valley, Valley-Devers	Not modeled Aug NQC	QF/Selfgen
SCE	VALLEY_5_RTS044	24160	VALLEYSC	115	3.28		LA Basin	Eastern, Valley, Valley-Devers	Not modeled Aug NQC	Market
SCE	VALLEY_5_SOLAR1	24160	VALLEYSC	115	0.00		LA Basin	Eastern, Valley, Valley-Devers	Not modeled Energy Only	Market
SCE	VALLEY_5_SOLAR2	25082	WDT786	34.5	8.20	EQ	LA Basin	Eastern, Valley, Valley-Devers	Aug NQC	Market
SCE	VALLEY_7_BADLND	24160	VALLEYSC	115	0.58		LA Basin	Eastern, Valley, Valley-Devers	Not modeled Aug NQC	Market
SCE	VALLEY_7_UNITA1	24160	VALLEYSC	115	2.56		LA Basin	Eastern, Valley, Valley-Devers	Not modeled Aug NQC	Market
SCE	VENWD_1_WIND1	25645	VENWIND	115	2.50	Q1	LA Basin	Eastern, Valley- Devers	Aug NQC	QF/Selfgen
SCE	VENWD_1_WIND2	25645	VENWIND	115	4.25	Q2	LA Basin	Eastern, Valley- Devers	Aug NQC	QF/Selfgen
SCE	VENWD_1_WIND3	25645	VENWIND	115	5.05	EU	LA Basin	Eastern, Valley- Devers	Aug NQC	QF/Selfgen

Attachment A - List of physical resources by PTO, local area and market ID

SCE	VERNON_6_GONZL1	24342	FEDGEN	13.8	5.75	1	LA Basin	Western		MUNI
SCE	VERNON_6_GONZL2	24342	FEDGEN	13.8	5.75	1	LA Basin	Western		MUNI
SCE	VERNON_6_MALBRG	24239	MALBRG1G	13.8	42.37	C1	LA Basin	Western		MUNI
SCE	VERNON_6_MALBRG	24240	MALBRG2G	13.8	42.37	C2	LA Basin	Western		MUNI
SCE	VERNON_6_MALBRG	24241	MALBRG3G	13.8	49.26	S3	LA Basin	Western		MUNI
SCE	VILLPK_2_VALLYV	24216	VILLA PK	66	4.10	DG	LA Basin	Western	Aug NQC	QF/Selfgen
SCE	VILLPK_6_MWDYOR	24216	VILLA PK	66	4.20		LA Basin	Western	Not modeled Aug NQC	MUNI
SCE	VISTA_2_RIALTO	24901	VSTA	230	0.41		LA Basin	Eastern, Eastern Metro	Energy Only	Market
SCE	VISTA_2_RTS028	24901	VSTA	230	1.44		LA Basin	Eastern, Eastern Metro	Not modeled Aug NQC	Market
SCE	VISTA_6_QF	24902	VSTA	66	0.06		LA Basin	Eastern, Eastern Metro	Not modeled Aug NQC	QF/Selfgen
SCE	WALCRK_2_CTG1	29201	WALCRKG1	13.8	96.00	1	LA Basin	Western		Market
SCE	WALCRK_2_CTG2	29202	WALCRKG2	13.8	96.00	1	LA Basin	Western		Market
SCE	WALCRK_2_CTG3	29203	WALCRKG3	13.8	96.00	1	LA Basin	Western		Market
SCE	WALCRK_2_CTG4	29204	WALCRKG4	13.8	96.00	1	LA Basin	Western		Market
SCE	WALCRK_2_CTG5	29205	WALCRKG5	13.8	96.65	1	LA Basin	Western		Market
SCE	WALNUT_2_SOLAR				0.00		LA Basin	Western	Not modeled Energy Only	Market
SCE	WALNUT_6_HILLGEN	24063	HILLGEN	13.8	39.51	D1	LA Basin	Western	Aug NQC	Net Seller
SCE	WALNUT_7_WCOVCT	24157	WALNUT	66	3.45		LA Basin	Western	Not modeled Aug NQC	Market
SCE	WALNUT_7_WCOVST	24157	WALNUT	66	5.51		LA Basin	Western	Not modeled Aug NQC	Market
SCE	WHTWTR_1_WINDA1	29061	WHITEWTR	33	16.30	1	LA Basin	Eastern, Valley- Devers	Aug NQC	Wind
SCE	ZZ_ARCOGN_2_UNITS	24018	BRIGEN	13.8	0.00	1	LA Basin	Western	No NQC - hist. data	Net Seller
SCE	ZZ_HINSON_6_QF	24064	HINSON	66	0.00	1	LA Basin	Western	No NQC - hist. data	QF/Selfgen
SCE	ZZ_LAFRES_6_QF	24332	PALOGEN	13.8	0.00	D1	LA Basin	Western, El Nido	No NQC - hist. data	QF/Selfgen
SCE	ZZ_MOBGEN_6_UNIT 1	24094	MOBGEN	13.8	0.00	1	LA Basin	Western, El Nido	No NQC - hist. data	QF/Selfgen

Attachment A - List of physical resources by PTO, local area and market ID

SCE	ZZ_NA	24327	THUMSGEN	13.8	0.00	1	LA Basin	Western	No NQC - hist. data	QF/Selfgen
SCE	ZZ_NA	24329	MOBGEN2	13.8	0.00	1	LA Basin	Western, El Nido	No NQC - hist. data	QF/Selfgen
SCE	ZZ_NA	24330	OUTFALL1	13.8	0.00	1	LA Basin	Western, El Nido	No NQC - hist. data	QF/Selfgen
SCE	ZZ_NA	24331	OUTFALL2	13.8	0.00	1	LA Basin	Western, El Nido	No NQC - hist. data	QF/Selfgen
SCE	ZZ_NA	29260	ALTAMSA4	115	0.00	1	LA Basin	Eastern, Valley-Devers	No NQC - hist. data	Wind
SCE	ZZZZ_New	90000	ALMT-GT1	18	200.00	X1	LA Basin	Western	No NQC - Pmax	Market
SCE	ZZZZ_New	90003	HUNT-GT1	18	202.00	X1	LA Basin	Western	No NQC - Pmax	Market
SCE	ZZZZ_New	90001	ALMT-GT2	18	200.00	X2	LA Basin	Western	No NQC - Pmax	Market
SCE	ZZZZ_New	90004	HUNT-GT2	18	202.00	X2	LA Basin	Western	No NQC - Pmax	Market
SCE	ZZZZ_New	90002	ALMT-ST1	18	240.00	X3	LA Basin	Western	No NQC - Pmax	Market
SCE	ZZZZ_New	90005	HUNT-ST1	18	240.00	X3	LA Basin	Western	No NQC - Pmax	Market
SCE	ZZZZZ_BRDWAY_7_UNIT 3	29007	BRODWYSC	13.8	0.00		LA Basin	Western	Retired	MUNI
SCE	ZZZZZ_ETIWND_7_UNIT 3	24052	MTNVIST3	18	0.00	3	LA Basin	Eastern, Eastern Metro	Retired	Market
SCE	ZZZZZ_ETIWND_7_UNIT 4	24053	MTNVIST4	18	0.00	4	LA Basin	Eastern, Eastern Metro	Retired	Market
SCE	ZZZZZZ_ELSEGN_7_UNIT 4	24048	ELSEG4 G	18	0.00	4	LA Basin	Western, El Nido	Retired	Market
SDG&E	BORDER_6_UNITA1	22149	CALPK_BD	13.8	48.00	1	SD-IV	San Diego, Border		Market
SDG&E	BREGGO_6_DEGRSL	22085	BORREGO	12.5	2.58	DG	SD-IV	San Diego	Aug NQC	Market
SDG&E	BREGGO_6_SOLAR	22082	BR GEN1	0.21	10.66	1	SD-IV	San Diego	Aug NQC	Market
SDG&E	CBRILLO_6_PLSTP1	22092	CABRILLO	69	2.72	1	SD-IV	San Diego	Aug NQC	Market
SDG&E	CCRITA_7_RPPCHF	22124	CHCARITA	138	2.00	1	SD-IV	San Diego	Aug NQC	Market
SDG&E	CHILLS_1_SYCENG	22120	CARLTNHS	138	0.67	1	SD-IV	San Diego	Aug NQC	QF/Selfgen
SDG&E	CHILLS_7_UNITA1	22120	CARLTNHS	138	1.52	2	SD-IV	San Diego	Aug NQC	QF/Selfgen
SDG&E	CNTNLA_2_SOLAR1	23463	DW GEN3&4	0.33	51.25	1	SD-IV	None	Aug NQC	Market
SDG&E	CNTNLA_2_SOLAR2	23463	DW GEN3&4	0.33	0.00	2	SD-IV	None	Energy Only	Market

Attachment A - List of physical resources by PTO, local area and market ID

SDG&E	CPSTNO_7_PRMADS	22112	CAPSTRNO	138	5.65	1	SD-IV	San Diego	Aug NQC	Market
SDG&E	CPVERD_2_SOLAR	23309	IV GEN3 G1	0.31	31.66	G1	SD-IV	None	Aug NQC	Market
SDG&E	CPVERD_2_SOLAR	23301	IV GEN3 G2	0.31	25.33	G2	SD-IV	None	Aug NQC	Market
SDG&E	CRELMN_6_RAMON1	22152	CREELMAN	69	0.82	DG	SD-IV	San Diego	Aug NQC	Market
SDG&E	CRELMN_6_RAMON2	22152	CREELMAN	69	2.05	DG	SD-IV	San Diego	Aug NQC	Market
SDG&E	CRSTWD_6_KUMYAY	22915	KUMEYAAY	0.69	13.25	1	SD-IV	San Diego	Aug NQC	Wind
SDG&E	CSLR4S_2_SOLAR	23298	DW GEN1 G1	0.32	26.65	G1	SD-IV	None	Aug NQC	Market
SDG&E	CSLR4S_2_SOLAR	23299	DW GEN1 G2	0.32	26.65	G2	SD-IV	None	Aug NQC	Market
SDG&E	DIVSON_6_NSQF	22172	DIVISION	69	44.23	1	SD-IV	San Diego	Aug NQC	QF/Selfgen
SDG&E	ELCAJN_6_EB1BT1	22208	EL CAJON	69	7.50	1	SD-IV	San Diego, El Cajon		Battery
SDG&E	ELCAJN_6_LM6K	23320	EC GEN2	13.8	48.10	1	SD-IV	San Diego, El Cajon		Market
SDG&E	ELCAJN_6_UNITA1	22150	EC GEN1	13.8	45.42	1	SD-IV	San Diego, El Cajon		Market
SDG&E	ENERSJ_2_WIND	23100	ECO GEN1 G1	0.69	41.10	G1	SD-IV	None	Aug NQC	Wind
SDG&E	ESCND0_6_EB1BT1	22256	ESCNDIDO	69	10.00	1	SD-IV	San Diego, Esco		Battery
SDG&E	ESCND0_6_EB2BT2	22256	ESCNDIDO	69	10.00	1	SD-IV	San Diego, Esco		Battery
SDG&E	ESCND0_6_EB3BT3	22256	ESCNDIDO	69	10.00	1	SD-IV	San Diego, Esco		Battery
SDG&E	ESCND0_6_PL1X2	22257	ESGEN	13.8	48.71	1	SD-IV	San Diego, Esco		Market
SDG&E	ESCND0_6_UNITB1	22153	CALPK_ES	13.8	48.00	1	SD-IV	San Diego, Esco		Market
SDG&E	ESCO_6_GLMQF	22332	GOALLINE	69	36.41	1	SD-IV	San Diego, Esco	Aug NQC	Net Seller
SDG&E	IVSLRP_2_SOLAR1	23440	DW GEN2 G1	0.36	82.00	1	SD-IV	None	Aug NQC	Market
SDG&E	IVWEST_2_SOLAR1	23155	DU GEN1 G1	0.2	33.27	G1	SD-IV	None	Aug NQC	Market
SDG&E	IVWEST_2_SOLAR1	23156	DU GEN1 G2	0.2	28.23	G2	SD-IV	None	Aug NQC	Market
SDG&E	JACMSR_1_JACSR1	23352	ECO GEN2	0.55	8.20	1	SD-IV	None	Aug NQC	Market
SDG&E	LAKHDG_6_UNIT 1	22625	LKHODG1	13.8	20.00	1	SD-IV	San Diego		Market
SDG&E	LAKHDG_6_UNIT 2	22626	LKHODG2	13.8	20.00	2	SD-IV	San Diego		Market
SDG&E	LARKSP_6_UNIT 1	22074	LRKSPBD1	13.8	46.00	1	SD-IV	San Diego, Border		Market
SDG&E	LARKSP_6_UNIT 2	22075	LRKSPBD2	13.8	46.00	1	SD-IV	San Diego, Border		Market

Attachment A - List of physical resources by PTO, local area and market ID

SDG&E	LAROA1_2_UNITA1	20187	LRP-U1	16	0.00	1	SD-IV	None	Connect to CENACE/CF E grid for the summer – not available for ISO BAA RA purpose	Market
SDG&E	LAROA2_2_UNITA1	22996	INTBST	18	145.19	1	SD-IV	None		Market
SDG&E	LAROA2_2_UNITA1	22997	INTBCT	16	176.81	1	SD-IV	None		Market
SDG&E	LILIAC_6_SOLAR	22404	LILIAC	69	1.23	DG	SD-IV	San Diego		Market
SDG&E	MRGT_6_MEF2	22487	MEF_MR2	13.8	47.90	1	SD-IV	San Diego, Miramar		Market
SDG&E	MRGT_6_MMAREF	22486	MEF_MR1	13.8	48.00	1	SD-IV	San Diego, Miramar		Market
SDG&E	MSHGTS_6_MMARLF	22448	MESAHGTS	69	4.42	1	SD-IV	San Diego, Mission	Aug NQC	Market
SDG&E	MSSION_2_QF	22496	MISSION	69	0.65	1	SD-IV	San Diego	Aug NQC	Market
SDG&E	MURRAY_6_UNIT	22532	MURRAY	69	0.00		SD-IV	San Diego	Not modeled Energy Only	Market
SDG&E	NIMTG_6_NIQF	22576	NOISLMTR	69	36.15	1	SD-IV	San Diego	Aug NQC	QF/Selfgen
SDG&E	OCTILO_5_WIND	23314	OCO GEN G1	0.69	35.12	G1	SD-IV	None	Aug NQC	Wind
SDG&E	OCTILO_5_WIND	23318	OCO GEN G2	0.69	35.12	G2	SD-IV	None	Aug NQC	Wind
SDG&E	OGROVE_6_PL1X2	22628	PA GEN1	13.8	48.00	1	SD-IV	San Diego, Pala Inner, Pala Outer		Market
SDG&E	OGROVE_6_PL1X2	22629	PA GEN2	13.8	48.00	1	SD-IV	San Diego, Pala Inner, Pala Outer		Market
SDG&E	OTAY_6_LNDFL5	22604	OTAY	69	0.00		SD-IV	San Diego, Border	Not modeled Energy Only	Market
SDG&E	OTAY_6_LNDFL6	22604	OTAY	69	0.00		SD-IV	San Diego, Border	Not modeled Energy Only	Market
SDG&E	OTAY_6_PL1X2	22617	OYGEN	13.8	35.50	1	SD-IV	San Diego, Border		Market
SDG&E	OTAY_6_UNITB1	22604	OTAY	69	2.16	1	SD-IV	San Diego, Border	Aug NQC	Market
SDG&E	OTAY_7_UNITC1	22604	OTAY	69	1.78	3	SD-IV	San Diego, Border	Aug NQC	QF/Selfgen
SDG&E	OTMESA_2_PL1X3	22605	OTAYMGT1	18	165.16	1	SD-IV	San Diego		Market
SDG&E	OTMESA_2_PL1X3	22606	OTAYMGT2	18	166.17	1	SD-IV	San Diego		Market
SDG&E	OTMESA_2_PL1X3	22607	OTAYMST1	16	272.27	1	SD-IV	San Diego		Market
SDG&E	PALOMR_2_PL1X3	22262	PEN_CT1	18	170.18	1	SD-IV	San Diego		Market

Attachment A - List of physical resources by PTO, local area and market ID

SDG&E	PALOMR_2_PL1X3	22263	PEN_CT2	18	170.18	1	SD-IV	San Diego		Market
SDG&E	PALOMR_2_PL1X3	22265	PEN_ST	18	225.24	1	SD-IV	San Diego		Market
SDG&E	PIOPIC_2_CTG1	23162	PIO PICO CT1	13.8	106.00	1	SD-IV	San Diego	No NQC - Pmax	Market
SDG&E	PIOPIC_2_CTG2	23163	PIO PICO CT2	13.8	106.00	1	SD-IV	San Diego	No NQC - Pmax	Market
SDG&E	PIOPIC_2_CTG3	23164	PIO PICO CT3	13.8	106.00	1	SD-IV	San Diego	No NQC - Pmax	Market
SDG&E	PTLOMA_6_NTCCGN	22660	POINTLMA	69	2.12	2	SD-IV	San Diego	Aug NQC	QF/Selfgen
SDG&E	PTLOMA_6_NTCQF	22660	POINTLMA	69	19.76	1	SD-IV	San Diego	Aug NQC	QF/Selfgen
SDG&E	SAMPNS_6_KELCO1	22704	SAMPSON	12.5	3.27	1	SD-IV	San Diego	Aug NQC	Net Seller
SDG&E	SMRCOS_6_LNDFIL	22724	SANMRCOS	69	1.50	1	SD-IV	San Diego	Aug NQC	Market
SDG&E	TERMEX_2_PL1X3	22982	TDM CTG2	18	156.44	1	SD-IV	None		Market
SDG&E	TERMEX_2_PL1X3	22983	TDM CTG3	18	156.44	1	SD-IV	None		Market
SDG&E	TERMEX_2_PL1X3	22981	TDM STG	21	280.13	1	SD-IV	None		Market
SDG&E	VLCNTR_6_VCSLR	22870	VALCNTR	69	0.96	DG	SD-IV	San Diego, Pala Inner, Pala Outer	Aug NQC	Market
SDG&E	VLCNTR_6_VCSLR1	22870	VALCNTR	69	1.03	DG	SD-IV	San Diego, Pala Inner, Pala Outer	Aug NQC	Market
SDG&E	VLCNTR_6_VCSLR2	22870	VALCNTR	69	2.05	DG	SD-IV	San Diego, Pala Inner, Pala Outer	Aug NQC	Market
SDG&E	VSTAES_6_VESBT1	23541	Q1061_BESS	0.48	20.00	1	SD-IV	San Diego, Esco, Pala Outer	No NQC - est. data	Battery
SDG&E	VSTAES_6_VESBT1	23216	Q1294_BESS	0.48	20.00	C9	SD-IV	San Diego, Esco, Pala Outer	No NQC - est. data	Battery
SDG&E	ZZ_NA	22916	PFC-AVC	0.6	0.00	1	SD-IV	San Diego	No NQC - hist. data	QF/Selfgen
SDG&E	ZZZ_New Unit	23287	Q429_G1	0.31	41.00	1	SD-IV	None	No NQC - est. data	Market
SDG&E	ZZZ_New Unit	23441	DW GEN2 G2	0.42	61.60	1	SD-IV	None	Aug NQC	Market
SDG&E	ZZZ_New unit	22783	EA5 REPOWER1	13.8	100.00	1	SD-IV	San Diego	No NQC - Pmax	Market
SDG&E	ZZZ_New unit	22784	EA5 REPOWER2	13.8	100.00	1	SD-IV	San Diego	No NQC - Pmax	Market
SDG&E	ZZZ_New unit	22786	EA5 REPOWER4	13.8	100.00	1	SD-IV	San Diego	No NQC - Pmax	Market
SDG&E	ZZZ_New unit	22787	EA5 REPOWER5	13.8	100.00	1	SD-IV	San Diego	No NQC - Pmax	Market

Attachment A - List of physical resources by PTO, local area and market ID

SDG&E	ZZZ_New unit	22788	EA5 REPOWER3	13.8	100.00	1	SD-IV	San Diego	No NQC - Pmax	Market
SDG&E	ZZZ_New Unit	22942	BUE GEN 1_G1	0.69	11.60	G1	SD-IV	None	No NQC - est. data	Wind
SDG&E	ZZZ_New Unit	22945	BUE GEN 1_G2	0.69	11.60	G2	SD-IV	None	No NQC - est. data	Wind
SDG&E	ZZZ_New Unit	22947	BUE GEN 1_G3	0.69	11.60	G3	SD-IV	None	No NQC - est. data	Wind
SDG&E	ZZZZ_New Unit	23443	DW GEN2 G3B	0.6	43.09	1	SD-IV	None	Aug NQC	Market
SDG&E	ZZZZ_New Unit	23442	DW GEN2 G3A	0.6	60.35	1	SD-IV	None	Aug NQC	Market
SDG&E	ZZZZ_New Unit	23131	Q183_G1	0.69	0.00	G1	SD-IV	None	Energy Only	Market
SDG&E	ZZZZ_New Unit	23134	Q183_G2	0.69	0.00	G2	SD-IV	None	Energy Only	Market
SDG&E	ZZZZ_New Unit	22949	BUE GEN 1_G4	0.69	26.00	G3	SD-IV	None	No NQC - est. data	Wind
SDG&E	ZZZZZ_ELCAJN_7_GT1	22212	ELCAJNGT	12.5	0.00	1	SD-IV	San Diego, El Cajon	Retired	Market
SDG&E	ZZZZZ_ENCINA_7_EA1	22233	ENCINA 1	14.4	0.00	1	SD-IV	San Diego, Encina	Retired	Market
SDG&E	ZZZZZ_ENCINA_7_EA2	22234	ENCINA 2	14.4	0.00	1	SD-IV	San Diego, Encina	Retired by 2019	Market
SDG&E	ZZZZZ_ENCINA_7_EA3	22236	ENCINA 3	14.4	0.00	1	SD-IV	San Diego, Encina	Retired by 2019	Market
SDG&E	ZZZZZ_ENCINA_7_EA4	22240	ENCINA 4	22	0.00	1	SD-IV	San Diego, Encina	Retired by 2019	Market
SDG&E	ZZZZZ_ENCINA_7_EA5	22244	ENCINA 5	24	0.00	1	SD-IV	San Diego, Encina	Retired by 2019	Market
SDG&E	ZZZZZ_ENCINA_7_GT1	22248	ENCINAGT	12.5	0.00	1	SD-IV	San Diego, Encina	Retired by 2019	Market
SDG&E	ZZZZZ_KEARNY_7_KY2	22373	KEARN2AB	12.5	0.00	1	SD-IV	San Diego, Mission	Retired	Market
SDG&E	ZZZZZ_KEARNY_7_KY2	22374	KEARN2CD	12.5	0.00	1	SD-IV	San Diego, Mission	Retired	Market
SDG&E	ZZZZZ_KEARNY_7_KY2	22373	KEARN2AB	12.5	0.00	2	SD-IV	San Diego, Mission	Retired	Market
SDG&E	ZZZZZ_KEARNY_7_KY2	22374	KEARN2CD	12.5	0.00	2	SD-IV	San Diego, Mission	Retired	Market
SDG&E	ZZZZZ_KEARNY_7_KY3	22375	KEARN3AB	12.5	0.00	1	SD-IV	San Diego, Mission	Retired	Market
SDG&E	ZZZZZ_KEARNY_7_KY3	22376	KEARN3CD	12.5	0.00	1	SD-IV	San Diego, Mission	Retired	Market

Attachment A - List of physical resources by PTO, local area and market ID

SDG&E	ZZZZ_KEARNY_7_KY3	22375	KEARN3AB	12.5	0.00	2	SD-IV	San Diego, Mission	Retired	Market
SDG&E	ZZZZ_KEARNY_7_KY3	22376	KEARN3CD	12.5	0.00	2	SD-IV	San Diego, Mission	Retired	Market
SDG&E	ZZZZ_MRGT_7_UNITS	22488	MIRAMRGT	12.5	0.00	1	SD-IV	San Diego, Miramar	Retired	Market
SDG&E	ZZZZ_MRGT_7_UNITS	22488	MIRAMRGT	12.5	0.00	2	SD-IV	San Diego, Miramar	Retired	Market

o

Attachment B – Effectiveness factors for procurement guidance

Table - Eagle Rock.

Effectiveness factors to the Eagle Rock-Cortina 115 kV line:

Gen Bus	Gen Name	Gen ID	Eff Fctr (%)
31406	GEYSR5-6	1	36
31406	GEYSR5-6	2	36
31408	GEYSER78	1	36
31408	GEYSER78	2	36
31412	GEYSER11	1	37
31435	GEO.ENGY	1	35
31435	GEO.ENGY	2	35
31433	POTTRVLY	1	34
31433	POTTRVLY	3	34
31433	POTTRVLY	4	34
38020	CITY UKH	1	32
38020	CITY UKH	2	32

Table - Fulton

Effectiveness factors to the Lakeville-Petaluma-Cotati 60 kV line:

Gen Bus	Gen Name	Gen ID	Eff Fctr (%)
31466	SONMA LF	1	52
31422	GEYSER17	1	12
31404	WEST FOR	1	12
31404	WEST FOR	2	12
31414	GEYSER12	1	12
31418	GEYSER14	1	12
31420	GEYSER16	1	12
31402	BEAR CAN	1	12
31402	BEAR CAN	2	12

Attachment B - Effectiveness factors for procurement guidance

Gen Bus	Gen Name	Gen ID	Eff Fctr (%)
38110	NCPA2GY1	1	12
38112	NCPA2GY2	1	12
32700	MONTICLO	1	10
32700	MONTICLO	2	10
32700	MONTICLO	3	10
31435	GEO.ENGY	1	6
31435	GEO.ENGY	2	6
31408	GEYSER78	1	6
31408	GEYSER78	2	6
31412	GEYSER11	1	6
31406	GEYSR5-6	1	6
31406	GEYSR5-6	2	6

Table - Lakeville

Effectiveness factors to the Vaca Dixon-Lakeville 230 kV line:

Gen Bus	Gen Name	Gen ID	Eff Fctr (%)
31400	SANTA FE	2	38
31430	SMUDGE01	1	38
31400	SANTA FE	1	38
31416	GEYSER13	1	38
31424	GEYSER18	1	38
31426	GEYSER20	1	38
38106	NCPA1GY1	1	38
38108	NCPA1GY2	1	38
31421	BOTTLERK	1	36
31404	WEST FOR	2	36
31402	BEAR CAN	1	36
31402	BEAR CAN	2	36
31404	WEST FOR	1	36
31414	GEYSER12	1	36
31418	GEYSER14	1	36
31420	GEYSER16	1	36

Attachment B - Effectiveness factors for procurement guidance

Gen Bus	Gen Name	Gen ID	Eff Fctr (%)
31422	GEYSER17	1	36
38110	NCPA2GY1	1	36
38112	NCPA2GY2	1	36
31446	SONMA LF	1	36
32700	MONTICLO	1	31
32700	MONTICLO	2	31
32700	MONTICLO	3	31
31406	GEYSR5-6	1	18
31406	GEYSR5-6	2	18
31405	RPSP1014	1	18
31408	GEYSER78	1	18
31408	GEYSER78	2	18
31412	GEYSER11	1	18
31435	GEO.ENGY	1	18
31435	GEO.ENGY	2	18
31433	POTTRVLY	1	15
31433	POTTRVLY	2	15
31433	POTTRVLY	3	15
38020	CITY UKH	1	15
38020	CITY UKH	2	15

Table – Rio Oso

Effectiveness factors to the Rio Oso-Atlantic 230 kV line:

Gen Bus	Gen Name	Gen ID	Eff Fctr. (%)
32498	SPILINCF	1	49
32500	ULTR RCK	1	49
32456	MIDLFORK	1	33
32456	MIDLFORK	2	33
32458	RALSTON	1	33

Attachment B - Effectiveness factors for procurement guidance

32513	ELDRADO1	1	32
32514	ELDRADO2	1	32
32510	CHILIBAR	1	32
32486	HELLHOLE	1	31
32508	FRNCH MD	1	30
32460	NEWCASTLE	1	26
32478	HALSEY F	1	24
32512	WISE	1	24
38114	Stig CC	1	14
38123	Q267CT	1	14
38124	Q267ST	1	14
32462	CHI.PARK	1	8
32464	DTCHFLT1	1	4

Table – South of Table Mountain

Effectiveness factors to the Caribou-Palermo 115 kV line:

Gen Bus	Gen Name	Gen ID	Eff Fctr. (%)
31814	FORBSTWN	1	7
31794	WOODLEAF	1	7
31832	SLY.CR.	1	7
31862	DEADWOOD	1	7
31890	PO POWER	1	6
31890	PO POWER	2	6
31888	OROVILLE	1	6
31834	KELLYRDG	1	6
32450	COLGATE1	1	4

Attachment B - Effectiveness factors for procurement guidance

Gen Bus	Gen Name	Gen ID	Eff Fctr. (%)
32466	NARROWS1	1	4
32468	NARROWS2	1	4
32452	COLGATE2	1	4
32470	CMP.FARW	1	4
32451	FREC	1	4
32490	GRNLEAF1	1	4
32490	GRNLEAF1	2	4
32496	YCEC	1	4
32494	YUBA CTY	1	4
32492	GRNLEAF2	1	4
32498	SPILINCF	1	2
31788	ROCK CK2	1	2
31812	CRESTA	1	2
31812	CRESTA	2	2
31820	BCKS CRK	1	2
31820	BCKS CRK	2	2
31786	ROCK CK1	1	2
31790	POE 1	1	2
31792	POE 2	1	2
31784	BELDEN	1	2
32500	ULTR RCK	1	2
32156	WOODLAND	1	2
32510	CHILIBAR	1	2
32513	ELDRADO1	1	2
32514	ELDRADO2	1	2
32478	HALSEY F	1	2
32460	NEWCASTLE	1	1

Attachment B - Effectiveness factors for procurement guidance

Gen Bus	Gen Name	Gen ID	Eff Fctr. (%)
32458	RALSTON	1	1
32512	WISE	1	1
32456	MIDLFORK	1	1
32456	MIDLFORK	2	1
32486	HELLHOLE	1	1
32508	FRNCH MD	1	1
32162	RIV.DLTA	1	1
32502	DTCHFLT2	1	1
32462	CHI.PARK	1	1
32464	DTCHFLT1	1	1
32454	DRUM 5	1	1
32476	ROLLINSF	1	1
32484	OXBOW F	1	1
32474	DEER CRK	1	1
32504	DRUM 1-2	1	1
32504	DRUM 1-2	2	1
32506	DRUM 3-4	1	1
32506	DRUM 3-4	2	1
32166	UC DAVIS	1	1
32472	SPAULDG	1	1
32472	SPAULDG	2	1
32472	SPAULDG	3	1
32480	BOWMAN	1	1
32488	HAYPRES+	1	1
32488	HAYPRES+	2	1
38124	LODI ST1	1	1
38123	LODI CT1	1	1

Attachment B - Effectiveness factors for procurement guidance

Gen Bus	Gen Name	Gen ID	Eff Fctr. (%)
38114	STIG CC	1	1

Table – San Jose

Effectiveness factors to the Newark-NRS 115 kV line:

Gen Bus	Gen Name	Gen ID	Eff Fctr (%)
36895	Gia200	1	25
36858	Gia100	1	25
36859	Laf300	2	23
36859	Laf300	1	23
36863	DVRaGT1	1	23
36864	DVRbGi2	1	23
36865	DVRaST3	1	23
35854	LECEFGT1	1	19
35855	LECEFGT2	1	19
35856	LECEFGT3	1	19
35857	LECEFGT4	1	19
35858	LECEFST1	1	19
35860	OLS-AGNE	1	19
35863	CATALYST	1	12

Table – South Bay-Moss Landing

Effectiveness factors to the Moss Landing-Las Aguillas 230 kV line:

Gen Bus	Gen Name	Gen ID	Eff Fctr. (%)
36209	SLD ENRG	1	20
36221	DUKMOSS1	1	20
36222	DUKMOSS2	1	20
36223	DUKMOSS3	1	20
36224	DUKMOSS4	1	20

Attachment B - Effectiveness factors for procurement guidance

36225	DUKMOSS5	1	20
36226	DUKMOSS6	1	20
36405	MOSSLND6	1	17
36406	MOSSLND7	1	17
35881	MEC CTG1	1	13
35882	MEC CTG2	1	13
35883	MEC STG1	1	13
35850	GLRY COG	1	12
35850	GLRY COG	2	12
35851	GROYPKR1	1	12
35852	GROYPKR2	1	12
35853	GROYPKR3	1	12
35623	SWIFT	BT	10
35863	CATALYST	1	10
36863	DVRaGT1	1	8
36864	DVRbGt2	1	8
36865	DVRaST3	1	8
36859	Laf300	2	8
36859	Laf300	1	8
36858	Gia100	1	7
36895	Gia200	1	7
35854	LECEFGT1	1	7
35855	LECEFGT2	1	7
35856	LECEFGT3	1	7
35857	LECEFGT4	1	7

Attachment B - Effectiveness factors for procurement guidance

35858	LECEFST1	1	7
35860	OLS-AGNE	1	7

Table – Ames/Pittsburg/Oakland

Effectiveness factors to the Ames-Ravenswood #1 115 kV line:

Gen Bus	Gen Name	Gen ID	Eff Fctr. (%)
35304	RUSELCT1	1	10
35305	RUSELCT2	2	10
35306	RUSELST1	3	10
33469	OX_MTN	1	10
33469	OX_MTN	2	10
33469	OX_MTN	3	10
33469	OX_MTN	4	10
33469	OX_MTN	5	10
33469	OX_MTN	6	10
33469	OX_MTN	7	10
33107	DEC STG1	1	3
33108	DEC CTG1	1	3
33109	DEC CTG2	1	3
33110	DEC CTG3	1	3
33102	COLUMBIA	1	3
33111	LMECCT2	1	3
33112	LMECCT1	1	3
33113	LMECST1	1	3
33151	FOSTER W	1	2

Attachment B - Effectiveness factors for procurement guidance

33151	FOSTER W	2	2
33151	FOSTER W	3	2
33136	CCCSD	1	2
33141	SHELL 1	1	2
33142	SHELL 2	1	2
33143	SHELL 3	1	2
32900	CRCKTCOG	1	2
32910	UNOCAL	1	2
32910	UNOCAL	2	2
32910	UNOCAL	3	2
32920	UNION CH	1	2
32921	ChevGen1	1	2
32922	ChevGen2	1	2
32923	ChevGen3	3	2
32741	HILLSIDE_12	1	2
32901	OAKLND 1	1	1
32902	OAKLND 2	2	1
32903	OAKLND 3	3	1
38118	ALMDACT1	1	1
38119	ALMDACT2	1	1

Effectiveness factors to the Moraga-C Claremont #2 115 kV line:

Gen Bus	Gen Name	Gen ID	Eff Fctr. (%)
32741	HILLSIDE_12	1	15
32921	ChevGen1	1	15

Attachment B - Effectiveness factors for procurement guidance

32922	ChevGen2	1	15
32923	ChevGen3	3	15
32920	UNION CH	1	14
32910	UNOCAL	1	13
32910	UNOCAL	2	13
32910	UNOCAL	3	13
32901	OAKLND 1	1	10
32902	OAKLND 2	2	10
32903	OAKLND 3	3	10
38118	ALMDACT1	1	10
38119	ALMDACT2	1	10
33141	SHELL 1	1	9
33142	SHELL 2	1	9
33143	SHELL 3	1	9
33136	CCCSO	1	8
32900	CRCKTCOG	1	7
33151	FOSTER W	1	6
33151	FOSTER W	2	6
33151	FOSTER W	3	6
33102	COLUMBIA	1	3
33111	LMECCT2	1	3
33112	LMECCT1	1	3
33113	LMECST1	1	3
33107	DEC STG1	1	3
33108	DEC CTG1	1	3

Attachment B - Effectiveness factors for procurement guidance

33109	DEC CTG2	1	3
33110	DEC CTG3	1	3

Table – Herndon

Effectiveness factors to the Herndon-Manchester 115 kV line:

Gen Bus	Gen Name	Gen ID	Eff Fctr. (%)
34624	BALCH 1	1	22
34616	KINGSRIV	1	21
34648	DINUBA E	1	20
34671	KRCDPCT1	1	19
34672	KRCDPCT2	1	19
34308	KERCKHOF	1	17
34343	KERCK1-2	2	17
34344	KERCK1-1	1	17
34345	KERCK1-3	3	17
34603	JGBSWLT	ST	15
34677	Q558	1	15
34690	CORCORAN_3	FW	15
34692	CORCORAN_4	FW	15
34696	CORCORANPV_S	1	15
34699	Q529	1	15
34610	HAAS	1	13
34610	HAAS	2	13
34612	BLCH 2-2	1	13
34614	BLCH 2-3	1	13

Attachment B - Effectiveness factors for procurement guidance

34431	GWF_HEP1	1	8
34433	GWF_HEP2	1	8
34617	Q581	1	5
34649	Q965	1	5
34680	KANSAS	1	5
34467	GIFFEN_DIST	1	4
34563	STROUD_DIST	2	4
34563	STROUD_DIST	1	4
34608	AGRICO	2	4
34608	AGRICO	3	4
34608	AGRICO	4	4
34644	Q679	1	4
36550	Q632BC1	1	4

Table – LA Basin

Effectiveness factors to the Mesa – Laguna Bell #1 230 kV line:

Gen Bus	Gen Name	Gen ID	Eff Fctr. (%)
29951	REFUSE	D1	35
24239	MALBRG1G	C1	34
24240	MALBRG1G	C2	34
24241	MALBRG1G	S3	34
29903	ELSEG6ST	6	27
29904	ELSEG5GT	5	27
29902	ELSEG7ST	7	27
29901	ELSEG8GT	8	27

Attachment B - Effectiveness factors for procurement guidance

24337	VENICE	1	26
24094	MOBGEN1	1	26
24329	MOBGEN2	1	26
24332	PALOGEN	D1	26
24011	ARCO 1G	1	23
24012	ARCO 2G	2	23
24013	ARCO 3G	3	23
24014	ARCO 4G	4	23
24163	ARCO 5G	5	23
24164	ARCO 6G	6	23
24062	HARBOR G	1	23
24062	HARBOR G	HP	23
25510	HARBORG4	LP	23
24327	THUMSGEN	1	23
24020	CARBGEN1	1	23
24328	CARBGEN2	1	23
24139	SERRFGEN	D1	23
24070	ICEGEN	1	22
24001	ALAMT1 G	1	18
24002	ALAMT2 G	2	18
24003	ALAMT3 G	3	18
24004	ALAMT4 G	4	18
24005	ALAMT5 G	5	18
24161	ALAMT6 G	6	18
90000	ALMT-GT1	X1	18

Attachment B - Effectiveness factors for procurement guidance

90001	ALMT-GT2	X2	18
90002	ALMT-ST1	X3	18
29308	CTRPKGEN	1	18
29953	SIGGEN	D1	18
29309	BARPKGEN	1	13
29201	WALCRKG1	1	12
29202	WALCRKG2	1	12
29203	WALCRKG3	1	12
29204	WALCRKG4	1	12
29205	WALCRKG5	1	12
29011	BREAPWR2	C1	12
29011	BREAPWR2	C2	12
29011	BREAPWR2	C3	12
29011	BREAPWR2	C4	12
29011	BREAPWR2	S1	12
24325	ORCOGEN	I	12
24341	COYGEN	I	11
25192	WDT1406_G	I	11
25208	DowlingCTG	1	10
25211	CanyonGT 1	1	10
25212	CanyonGT 2	2	10
25213	CanyonGT 3	3	10
25214	CanyonGT 4	4	10
24216	VILLA PK	DG	9

Attachment B - Effectiveness factors for procurement guidance

Table – Rector

Effectiveness factors to the Rector-Vestal 230 kV line:

Gen Bus	Gen Name	Gen ID	MW Eff Fctr (%)
24370	KAWGEN	1	51
24306	B CRK1-1	1	45
24306	B CRK1-1	2	45
24307	B CRK1-2	3	45
24307	B CRK1-2	4	45
24319	EASTWOOD	1	45
24323	PORTAL	1	45
24308	B CRK2-1	1	45
24308	B CRK2-1	2	45
24309	B CRK2-2	3	45
24309	B CRK2-2	4	45
24310	B CRK2-3	5	45
24310	B CRK2-3	6	45
24315	B CRK 8	81	45
24315	B CRK 8	82	45
24311	B CRK3-1	1	45
24311	B CRK3-1	2	45
24312	B CRK3-2	3	45
24312	B CRK3-2	4	45
24313	B CRK3-3	5	45
24317	MAMOTH1G	1	45
24318	MAMOTH2G	2	45
24314	B CRK 4	41	43
24314	B CRK 4	42	43

Attachment B - Effectiveness factors for procurement guidance

Table – San Diego

Effectiveness factors to the Imperial Valley – El Centro 230 kV line (i.e., the “S” line):

Gen Bus	Gen Name	Gen ID	Eff Fctr. (%)
22982	TDM CTG2	1	25
22983	TDM CTG3	1	25
22981	TDM STG	1	25
22997	INTBCT	1	25
22996	INTBST	1	25
23440	DW GEN2 G1	1	25
23298	DW GEN1 G1	G1	25
23156	DU GEN1 G2	G2	25
23299	DW GEN1 G2	G2	25
23155	DU GEN1 G1	G1	25
23441	DW GEN2 G2	1	25
23442	DW GEN2 G3A	1	25
23443	DW GEN2 G3B	1	25
23314	OCO GEN G1	G1	23
23318	OCO GEN G2	G2	23
23100	ECO GEN1 G	G1	22
23352	ECO GEN2 G	1	21
22605	OTAYMGT1	1	18
22606	OTAYMGT2	1	18
22607	OTAYMST1	1	18
23162	PIO PICO CT1	1	18
23163	PIO PICO CT2	1	18

Attachment B - Effectiveness factors for procurement guidance

23164	PIO PICO CT3	1	18
22915	KUMEYAAY	1	17
23320	EC GEN2	1	17
22150	EC GEN1	1	17
22617	OY GEN	1	17
22604	OTAY	1	17
22604	OTAY	3	17
22172	DIVISION	1	17
22576	NOISLMTR	1	17
22704	SAMPSON	1	17
22092	CABRILLO	1	17
22074	LRKSPBD1	1	17
22075	LRKSPBD2	1	17
22660	POINTLMA	1	17
22660	POINTLMA	2	17
22149	CALPK_BD	1	17
22448	MESAHGTS	1	16
22120	CARLTNHS	1	16
22120	CARLTNHS	2	16
22496	MISSION	1	16
22486	MEF MR1	1	16
22124	CHCARITA	1	16
22487	MEF MR2	1	16
22625	LkHodG1	1	16
22626	LkHodG2	2	16

Attachment B - Effectiveness factors for procurement guidance

22332	GOALLINE	1	15
22262	PEN_CT1	1	15
22153	CALPK_ES	1	15
22786	EA GEN1 U6	1	15
22787	EA GEN1 U7	1	15
22783	EA GEN1 U8	1	15
22784	EA GEN1 U9	1	15
22789	EA GEN1 U10	1	15
22257	ES GEN	1	15
22263	PEN_CT2	1	15
22265	PEN_ST	1	15
22724	SANMRCOS	1	15
22628	PA GEN1	1	14
22629	PA GEN2	1	14
22082	BR GEN1	1	14
22112	CAPSTRNO	1	12

Attachment C – Gas-fired generation based on general flexibility attributes

Figure C-1 Greater Bay Area Gas-Fired Flexible Attributes

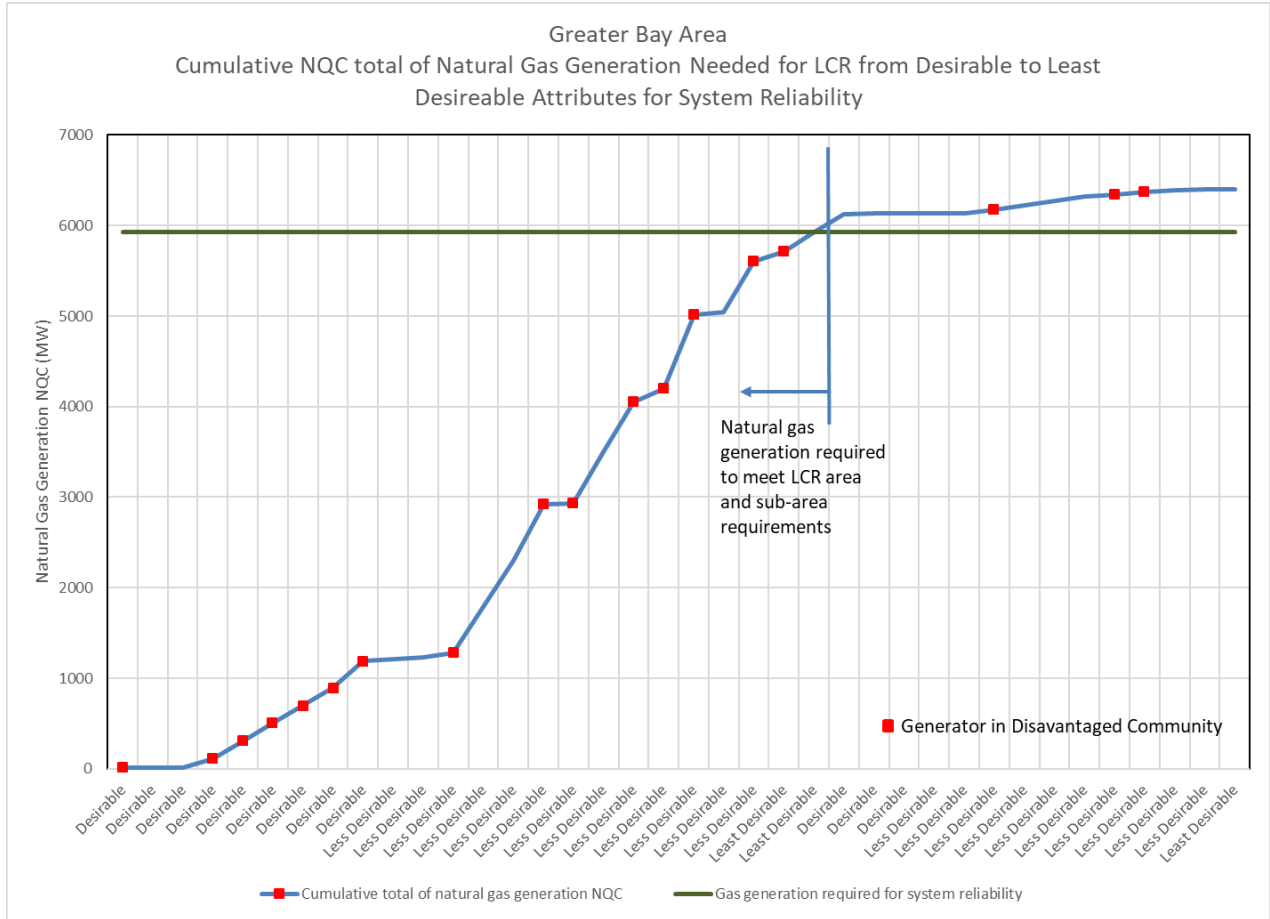

Attachment C - Gas-fired generation based on general flexibility attributes

Figure C-3 LA Basin Area Gas-Fired Flexible Attributes

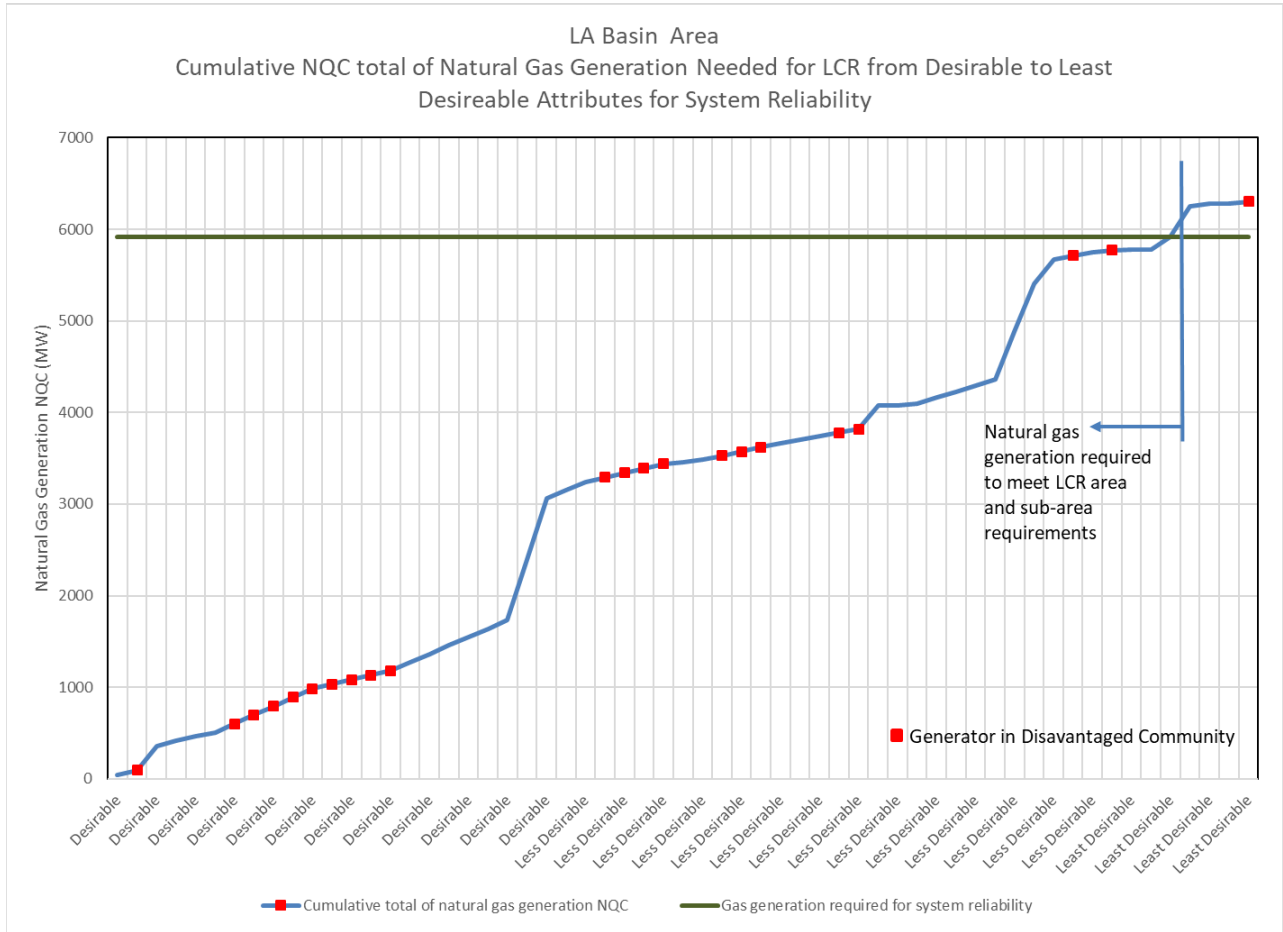

Attachment C - Gas-fired generation based on general flexibility attributes

Figure C-1 San Diego and IV Area Gas-Fired Flexible Attributes

